

TM-RANGER SERIES

TECHNICAL MANUAL FOR
OPERATION AND MAINTENANCE
OF SILENCER MODEL

RANGER SERIES

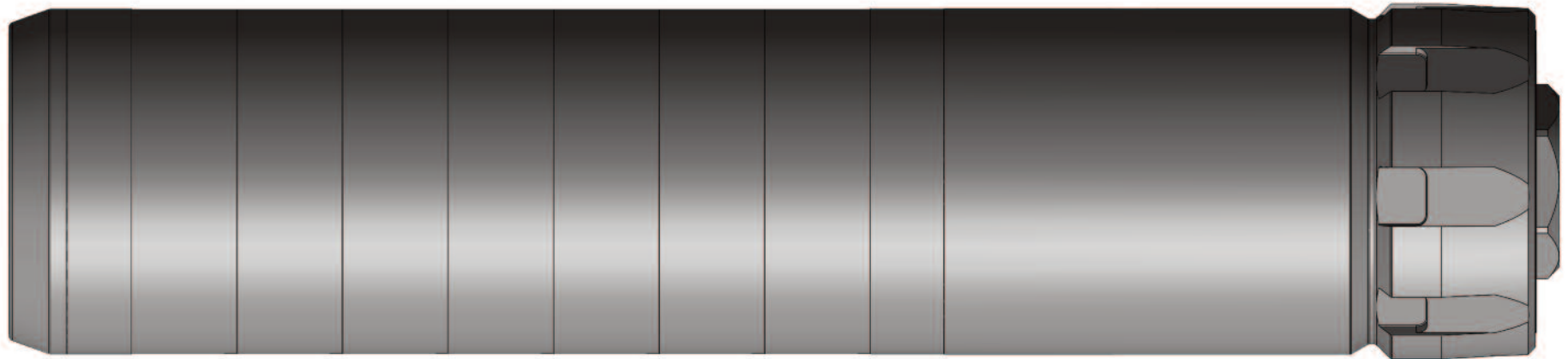

AAC
ADVANCED ARMAMENT CO.

5021 Bradford Drive, Suite A
Huntsville, AL 35805

ADVANCED ARMAMENT CO.

Limited Lifetime Warranty for Silencers

ADVANCED ARMAMENT CO. ("AAC") warrants to the original purchaser ("Purchaser") of a new Silencer from AAC that such Silencer shall be free from defects in material and workmanship for the duration of time that the Purchaser originally owns that Silencer. AAC, in its sole discretion, shall repair or replace the Silencer if the Purchaser submits a valid warranty claim in accordance with these instructions. If AAC opts to replace the Silencer, AAC will keep the Silencer that it replaces. The Purchaser's remedies under this warranty are limited to repair or replacement of the Silencer; AAC will not provide cash, credit, or refund. AAC does not warrant against any type of defect to the Silencer that AAC did not cause, including but not limited to defects or failures arising out of:

1. Failure to provide proper care and maintenance,
2. Accidents, abuse, or misuse,
3. Silencer obstruction,
4. Hand loaded, reloaded, or improper ammunition,
5. Unauthorized adjustments, repairs, or modifications, or
6. Normal wear and tear.

Additionally, AAC EXCLUDES AND WILL NOT PAY INCIDENTAL OR CONSEQUENTIAL DAMAGES UNDER THIS WARRANTY. THIS WARRANTY ALSO EXCLUDES ANY OTHER WARRANTIES, TO INCLUDE IMPLIED WARRANTIES. Furthermore, no individual or entity other than AAC possesses the authority to alter the obligations, limitations, disclaimers, or exclusions under this warranty. AAC's obligations under this warranty shall not apply to the extent that any law, regulation, or other governmental requirements prohibits the repair, replacement and, or, return of a Silencer to the person who shipped the Silencer to AAC.

The Purchaser, in order to achieve eligibility under this warranty, must be able to produce, on request, Purchaser's original sales receipt for the Silencer that clearly indicates that Purchaser is the original purchaser at retail. The Purchaser, upon discovering a defect in material or workmanship in the silencer, shall contact AAC at 800-581-1610 or techinfo@advanced-armament.com

Upon receiving the Purchaser's correspondence or phone call, AAC shall provide instructions to the Purchaser governing the manner in which to return the Silencer for repair or replacement.

Repair Policy

Should the silencer require repair or modification, the owner should contact AAC Customer Service to secure a Return Merchandise Authorization (RMA). Once the customer has the RMA, they may then ship the silencer insured to AAC for evaluation and repair, along with a photocopy of the approved form proving ownership and a brief letter detailing the customer's concerns and contact information.

Manufacturer's Disclaimer

ADVANCED ARMAMENT CO. shall not be responsible in any manner whatsoever for physical injury or property damage stemming from criminal or negligent misuse, improper or careless handling, unauthorized modifications, defective, improper hand-loaded or reloaded ammunition, neglect, or other influences beyond our direct and immediate control. If you do not understand the instructions and recommendations in this manual, contact ADVANCED ARMAMENT CO. at 800-581-1610 for clarification.

This manual contains operating, care, and maintenance instructions. To assure safe operation, any user of this silencer must read and understand this manual before using the silencer. Failure to follow the instructions and heed the warnings in this manual can cause property damage, personal injury, and/or death. This manual should always accompany this silencer, and be transferred with it upon change of ownership.

WARNING Keep this silencer out of the reach of children, unauthorized and/or prohibited individuals, and others unfamiliar with the safe handling of firearms and silencers.

	Alert Symbols and Definitions:
WARNING!	Indicates a hazardous situation which, if not avoided, could result in property damage, personal injury, or death.
CAUTION!	Indicates a hazardous situation which, if not avoided, could result in minor to moderate personal injury.
NOTE:	Addresses practices not relating to personal injury.

© 2022 ADVANCED ARMAMENT CO.

OPERATIONAL MANUAL FOR SILENCER MODEL RANGER SERIES

Distributed by

ADVANCED ARMAMENT CO.

Phone: (770) 925-9988

www.advanced-armament.com

CONTENTS:

The Ten Commandments of Firearm Safety.....	P.3
General description.....	P.3
Configuring a RANGER for Fast-Attach use.....	P.4
Configuring a RANGER for Direct-Thread use.....	P.6
Installing RANGER Fast-Attach onto a host firearm.....	P.7
Removing RANGER Fast-Attach from a host firearm.....	P.9
Installing RANGER Direct-Thread onto a host firearm.....	P.10
Removing RANGER Direct-Thread from a host firearm.....	P.12
Cleaning the RANGER	P.12

THE TEN COMMANDMENTS OF FIREARM SAFETY

1. Always keep the muzzle pointed in a safe direction.
2. Firearms should be unloaded when not actually in use.
3. Do not rely on your firearm's safety.
4. Be sure of your target and what is beyond it.
5. Only use ammunition that exactly matches the markings on your firearm.
6. If your firearm fails to fire when the trigger is pulled, handle with care.
7. Always wear eye and hearing protection when shooting.
8. Be sure the barrel is clear of obstructions before shooting.
9. Do not alter or modify your firearm and have it serviced regularly.
10. Learn the mechanics and handling characteristics of your firearm.
Read your firearm's instruction manual.

WARNING! Failure to follow the instructions and recommendations set forth in this manual can create a potentially dangerous situation for the user and surrounding personnel, possibly leading to property damage, personal injury and/or death.

WARNING! DO NOT shoot through a RANGER SERIES silencer that is mounted on a BLACKOUT® Silencer-Mounting muzzle device that has not been installed onto the host rifle using the included Rocksett sealant and recommended torque fastening. Mounting and shooting through a RANGER SERIES silencer that is mounted to an unsecured BLACKOUT Silencer-Mounting muzzle device could lead to property damage, personal injury and/or death.

WARNING! DO NOT use an auxiliary thread adapter between your host weapon barrel and a BLACKOUT Silencer-Mounting muzzle device. Using an auxiliary thread adapter between your host weapon barrel and a BLACKOUT Silencer-Mounting muzzle device could lead to misalignment between the host weapon bore and the RANGER SERIES silencer, which could lead to property damage, personal injury and/or death.

WARNING! We recommend having your BLACKOUT Silencer-Mounting muzzle device installed by a competent gunsmith or armorer. Neither Advanced Armament Co. nor its affiliates are liable for damage(s) to the host weapon, silencer, and user attributed to improper installation. An improperly installed or misaligned BLACKOUT Silencer-

Mounting muzzle device can create a potentially dangerous situation for the user and surrounding personnel, and may lead to property damage, personal injury and/or death.

WARNING! Always wear protective gear, such as eye protection and solvent-resistant gloves when working with any solvent. Only use solvents in a well-ventilated area away from open flames. Unsafe use of solvents may lead to property damage, personal injury and/or death.

WARNING! DO NOT use a crush washer or compression washer when installing a BLACKOUT Silencer-Mounting muzzle device. Installing a BLACKOUT Silencer-Mounting muzzle device with a crush washer or compression washer can lead to misalignment of a BLACKOUT Silencer-Mounting muzzle device and the host weapon bore. Misalignment of a BLACKOUT Silencer-Mounting muzzle device and the host weapon bore can create a dangerous situation that may lead to property damage, personal injury and/or death.

WARNING! Never install or remove a silencer on or from a host firearm that you have not verified to be completely empty and rendered safe. Installing or removing a silencer on or from a loaded firearm may lead to property damage, personal injury and/or death.

WARNING! The RANGER SERIES is designed for use on modern rifles and carbines in serviceable condition. It is the user's responsibility to ensure the intended host firearm is in serviceable condition. Using a RANGER SERIES on firearms that are not in serviceable condition can lead to property damage, personal injury and/or death.

WARNING! The barrel threads must be properly machined to allow proper attachment of a BLACKOUT Silencer-Mounting muzzle device. The use of an improperly threaded barrel with a BLACKOUT Silencer-Mounting muzzle device may lead to property damage, personal injury and/or death. For further clarification on muzzle threads, contact Advanced Armament Co. at 770-925-9988.

WARNING! The bore through your RANGER SERIES must align concentrically with the bore of the barrel to which it is mounted. A misalignment of the silencer and barrel bore may lead to property damage, personal injury and/or death.

WARNING! Discharging silenced firearms can make airborne and/or

deposit lead and other substances around, on and in the silencer. Using, handling and/or cleaning a silencer may result in exposure to lead and other substances known to cause birth defects, reproductive harm, cancer and other serious physical injury. Have adequate ventilation at all times and wash hands thoroughly after exposure.

CAUTION! Silencers can become extremely hot while the host firearm is being discharged. After shooting, allow the silencer to reach ambient temperature before attempting to remove the silencer from the firearm. If removal is necessary prior to the silencer cooling to ambient and/or the tightness of the silencer on the host firearm barrel must be verified, the use of heat-resistant gloves is mandatory. Handling a hot silencer without heat resistant gloves may lead to skin burns and/or personal injury.

CAUTION! Always wear eye and hearing protection when discharging a firearm. Discharging a firearm without wearing eye and hearing protection may lead to personal injury.

GENERAL DESCRIPTION

Congratulations! You are now the proud owner of AAC's newest user-configurable sound and flash suppressor for 5.56mm and 7.62mm rifles and carbines. The RANGER SERIES can be configured as either a direct-thread or fast-attach suppressor in seconds using the industry-standard 1-3/8-24 threaded socket. In addition to the ease of configuring the mounting apparatus, the RANGER SERIES feature removable front end cap inserts that can be easily removed and replaced in the event of damage. The RANGER SERIES are constructed of fully laser welded 17-4 stainless steel and Inconel 718 for light-weight and durability. The revolutionary design and construction of the RANGER SERIES baffle core significantly reduces felt recoil, environmental disturbance, and aids in the preservation of the hearing of shooters and observers. In numerous circumstances, the RANGER SERIES may deliver an overall sound signature below the pain threshold and risk limit for hearing loss*. The RANGER SERIES is finished with a combination of Cerakote and matte black nitride.

* The cumulative effects of sound on hearing are influenced by multiple factors, including but not limited to the sound level, the total amount of time (or number of times) one is exposed, barrel length, type of firearm operating system, ammunition selection, and the surrounding environment. Also, unforeseen events, such as case ruptures, can expose the user and by-

standers to sound levels well beyond the level of suppressed fire. For these reasons, AAC recommends the use of hearing protection, even when shooting with a suppressor.

CONFIGURING A RANGER FOR FAST-ATTACH USE

The industry-standard 1-3/8-24 threaded socket used with the RANGER SERIES makes it possible to employ fast-attach adapters from other manufacturers with the RANGER SERIES. Prior to using other manufacturers fast-attach adapters with the RANGER SERIES, it is the responsibility of the user to ensure the adapters are fully compatible with the RANGER SERIES. Refer to the other manufacturers fast-attach adapter installation and removal instructions. The following instructions cover installation and use of AAC designed fast-attach adapters.

WARNING! Only perform configuration changes on silencers that are not mounted to a firearm. Attempting configuration changes on a mounted silencer could lead to property damage, personal injury and/or death.

1. If the RANGER SERIES is mounted to a host firearm, dismount it following the procedure outlined in "Removing the RANGER SERIES from a host firearm" in this manual.
2. If the RANGER SERIES is configured for direct-thread use, remove the direct-thread adapter following the procedure outlined in "Configuring the RANGER SERIES for direct-thread use" in this manual.
3. Inspect the threaded socket and tapered sealing surface in the rear of the suppressor to ensure they are clean and free of damage. See Figure 1.

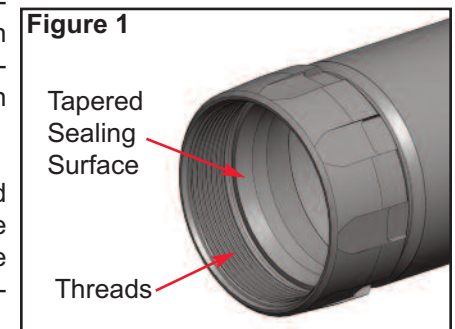

WARNING! Never attempt to install an adapter in a RANGER SERIES silencer with threads or tapered sealing surfaces that are dirty or damaged, as this may lead to property damage, personal injury and/or death.

4. Inspect the threads and tapered sealing surface on the outside of the fast-attach adapter to ensure they are clean and free of damage. See Figure 2.

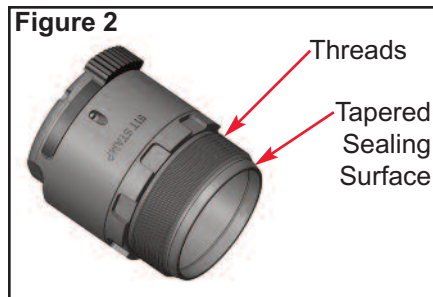

5. Apply a light coat of high-temperature grease or anti-seize to the threads and tapered sealing surface on the outside of the fast-attach mount. See Figure 3.



6. Thread the fast-attach mount into the silencer until the tapered sealing surface on the outside of the fast-attach mount seats against the mating tapered sealing surface inside the silencer. See Figure 4.

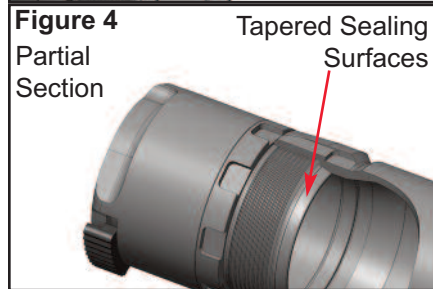

7. Use a spanner to tighten the fast-attach mount into the silencer. See Figure 5.

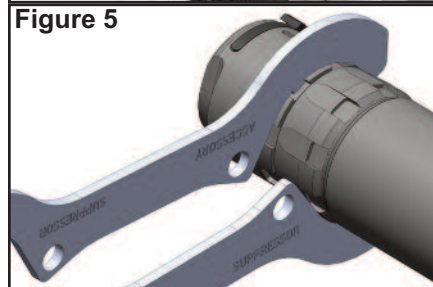

8. To remove a fast-attach adapter from a dismounted RANGER SERIES silencer, use a spanner to break loose the fast-attach adapter and unthread it and remove it by hand.

9. Inspect the threads and tapered sealing surface on the outside of the fast-attach adapter to ensure they are clean and free of damage.

10. Inspect the threaded socket and tapered sealing surface in the rear of the suppressor to ensure they are clean and free of damage.

WARNING! It is the responsibility of the user to ensure the silencer stays securely threaded into the RANGER SERIES silencer. Failure

to do so may lead to property damage, personal injury and/or death.

CONFIGURING A RANGER FOR DIRECT-THREAD USE

The industry-standard 1-3/8-24 threaded socket used with the RANGER SERIES makes it possible to employ direct-thread adapters from other manufacturers with the RANGER SERIES. Prior to using other manufacturers direct-thread adapters with the RANGER SERIES, it is the responsibility of the user to ensure the adapters are fully compatible with the RANGER SERIES. Refer to the other manufacturers direct-thread adapter installation and removal instructions. The following instructions cover installation and use of AAC designed direct-thread adapters.

WARNING! Only perform configuration changes on silencers that are not mounted to a firearm. Attempting configuration changes on a mounted silencer could lead to property damage, personal injury and/or death.

1. If the RANGER SERIES is mounted to a host firearm, dismount it following the procedure outlined in "Removing the RANGER SERIES from a host firearm" in this manual.
2. If the RANGER SERIES is configured for fast-attach use, remove the fast-attach adapter following the procedure outlined in "Configuring the RANGER SERIES for fast-attach use" in this manual.

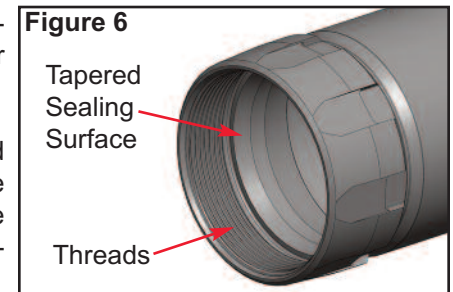

3. Inspect the threaded socket and tapered sealing surface in the rear of the suppressor to ensure they are clean and free of damage. See Figure 6.

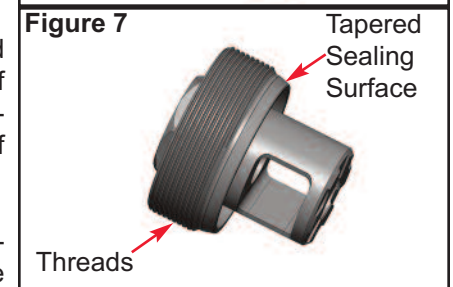

4. Inspect the threads and tapered sealing surface on the outside of the direct-thread adapter to ensure they are clean and free of damage. See Figure 7.

5. Apply a light coat of high-temperature grease or anti-seize to the

threads and tapered sealing surface on the outside of the direct-thread mount. See Figure 8.

6. Thread the direct-thread mount into the silencer until the tapered sealing surface on the outside of the direct-thread mount seats against the mating tapered sealing surface inside the silencer. See Figure 9.

7. Use a $\frac{3}{4}$ " socket to tighten the direct-thread mount into the silencer. See Figure 10.

8. To remove a direct-thread adapter from a dismounted RANGER SERIES silencer, use a $\frac{3}{4}$ " socket to break loose the fast-attach adapter and unthread it and remove it by hand.

9. Inspect the threads and tapered sealing surface on the outside of the $\frac{3}{4}$ " socket adapter to ensure they are clean and free of damage.

10. Inspect the threaded socket and tapered sealing surface in the rear of the suppressor to ensure they are clean and free of damage.

INSTALLING A RANGER SERIES SILENCER CONFIGURED FOR FAST-ATTACH USE ONTO A HOST FIREARM

WARNING! Never attempt to attach a RANGER SERIES to a BLACKOUT Silencer-Mounting muzzle device with threads that are dirty or damaged, as this may lead to property damage, personal injury and/or death.

WARNING! Never attempt to attach a RANGER SERIES with dirty or

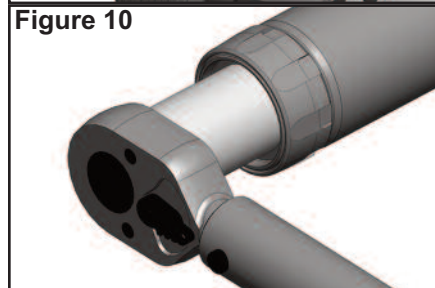
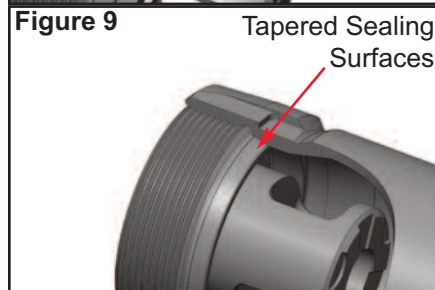
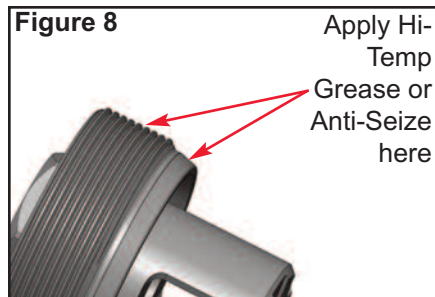

damaged threads to a BLACKOUT Silencer-Mounting muzzle device, as this may lead to property damage, personal injury and/or death.

WARNING! Never use a silencer with an obstructed bore, as this may lead to property damage, personal injury and/or death.

1. Always keep the firearm pointed in a safe direction.

2. Render the firearm safe by removing the magazine, completely unloading the firearm and engaging the safety mechanism to the "SAFE" position. See the firearm's owner's manual for detailed instructions.

3. Inspect the threads on the exterior of the BLACKOUT Silencer-Mounting muzzle device, the toothed gear behind the threads, and the silencer alignment surfaces to verify they are clean and undamaged. See Figure 11.

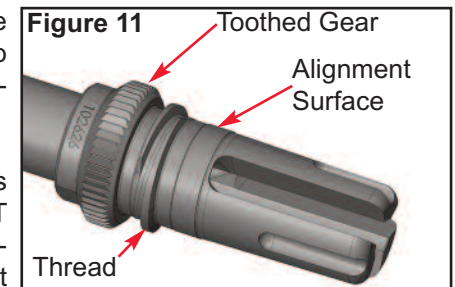

4. Verify the fast-attach mount is compatible with the BLACKOUT Silencer-Mounting muzzle device mounted to the host firearm. The fast-attach mount designation is marked on the mount. See Figure 12.

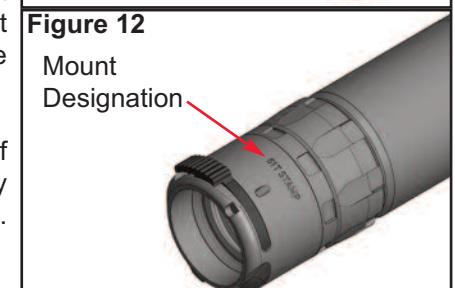

5. Inspect the threads in the rear of the Fast-Attach Mount to verify they are clean and undamaged. See Figure 13.



6. Look through the silencer from the rear to ensure the bullet path through the silencer is unobstructed.

7. Examine the silencer for any signs of damage.

8. Grasp the silencer by the in-

stalled mount and slide the RANGER SERIES over the BLACKOUT Silencer-Mounting muzzle device. See Figure 14.

9. Hold the RANGER SERIES by the mount and while keeping the textured thumb pad of the latch depressed, carefully screw the silencer onto the 90T Ratchet Taper BLACKOUT Silencer-Mounting muzzle device threads in the direction indicated in Figure 15.

10. Tighten the silencer fully onto the BLACKOUT Silencer-Mounting muzzle device hand-tight. With a 90T Ratchet Taper mount, tighten just until the tapered alignment surface adjacent to the toothed gear on the 90T Ratchet Taper BLACKOUT Silencer-Mounting muzzle device engages the mating tapered alignment surface in the rear of the RANGER SERIES silencer. With a S.T.A.M.P. Mount, after 1-1/2 to 2 turns, tension from the S.T.A.M.P. Mount™ can be felt. When either mount is fully engaged with the BLACKOUT Silencer-Mounting muzzle device, release tension on the textured thumb pad. There should be no perceptible movement between the BLACKOUT Silencer-Mounting muzzle device/host rifle and the RANGER SERIES silencer.

WARNING! User must ensure the silencer stays securely threaded to the BLACKOUT Silencer-Mounting muzzle device during use. Failure to ensure the silencer stays securely threaded to the BLACKOUT Silencer-Mounting muzzle device may lead to property damage, personal injury and/or death.

NOTE. Do not over-tighten the silencer onto the BLACKOUT Silencer-Mounting muzzle device/host firearm, as it may be difficult to remove.

REMOVING A RANGER SERIES SILENCER CONFIGURED FOR FAST-ATTACH USE FROM A HOST FIREARM

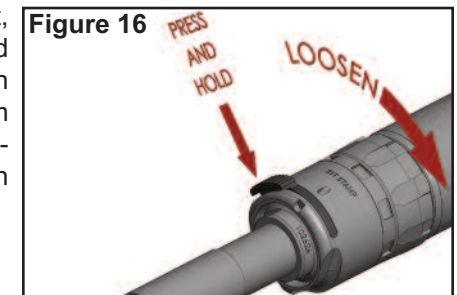
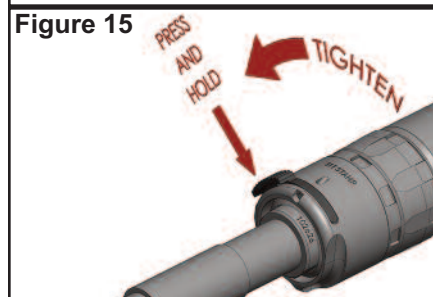
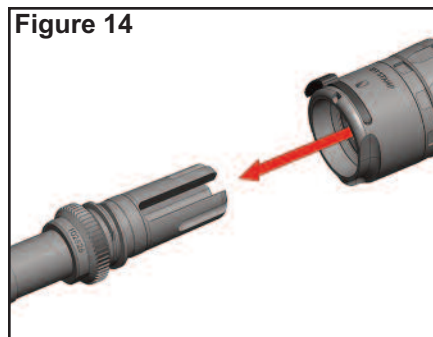

1. Keep the host firearm pointed in a safe direction.
2. Render the firearm safe by removing the magazine, completely unloading the firearm and engaging the safety mechanism to the "SAFE" position. See the firearm's owner's manual for detailed instructions.
3. Verify the silencer is at ambient temperature. If the silencer is hot, allow it to cool.

CAUTION! Never handle a hot silencer without heat-resistant gloves, as this may lead to skin burns and/or personal injury.

4. While firmly grasping the mount, depress and hold the textured thumb-pad on the ratchet latch and unscrew the silencer from the BLACKOUT Silencer-Mounting muzzle device in the direction indicated in Figure 16.

INSTALLING A RANGER SERIES SILENCER CONFIGURED FOR DIRECT-THREAD USE ONTO A HOST FIREARM

WARNING! Never attempt to attach a RANGER SERIES to muzzle threads that are dirty or damaged, as this may lead to property damage, personal injury and/or death.

WARNING! Never attempt to attach a RANGER SERIES with dirty or damaged threads to a threaded muzzle, as this may lead to property damage, personal injury and/or death.

WARNING! Never use a silencer with an obstructed bore, as this may lead to property damage, personal injury and/or death.

1. Always keep the firearm pointed in a safe direction.
2. Render the firearm safe by removing the magazine, completely unloading the firearm and engaging the safety mechanism to the "SAFE" position. See the firearm's owner's manual for detailed instructions.

3. Remove the existing flash hider and any washers or shims from the host firearm muzzle.
4. Clean the threads and shoulder on the host-firearm muzzle and verify they are undamaged. See Figure 17.
5. Verify the thread specification on the Direct-Thread mount matches the threads on the host firearm muzzle. The mount thread specification is marked on the mount. See Figure 18.
6. Inspect the threads in the rear of the Direct-Thread Mount to verify they are clean and undamaged. See Figure 19.
7. Look through the silencer from the rear to ensure the bullet path through the silencer is unobstructed.
8. Examine the silencer for any signs of damage.
9. Hold the silencer by the direct-thread mount and carefully screw it onto the muzzle threads in the direction indicated in Figure 20. Thread the silencer on completely so that the rear of the direct-thread mount sits flush and square against the shoulder behind the threads. See Figure 21.

WARNING! User must ensure the silencer stays securely threaded

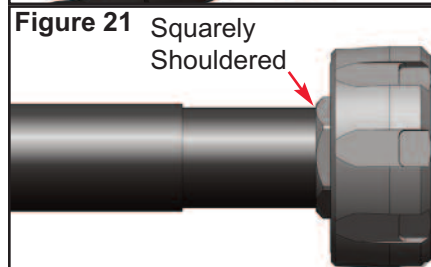
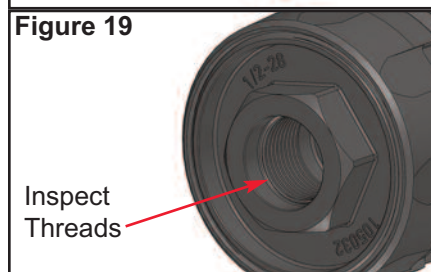
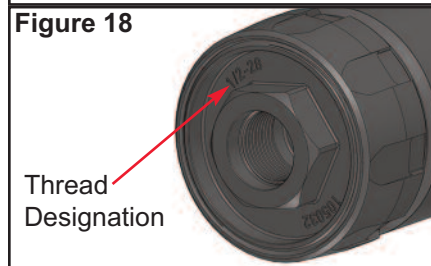
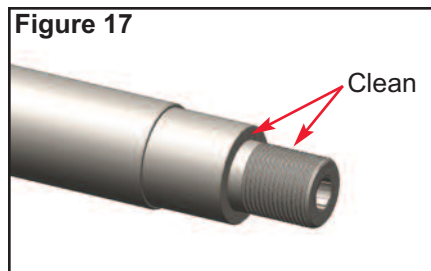

to the host-firearm muzzle threads during use. Failure to ensure the silencer stays securely threaded to the host-firearm muzzled threads may lead to property damage, personal injury and/or death.

REMOVING A RANGER SERIES SILENCER CONFIGURED FOR DIRECT-THREAD USE FROM A HOST FIREARM

1. Always keep the host firearm pointed in a safe direction.
2. Render the firearm safe by removing the magazine, completely unloading the firearm and engaging the safety mechanism to the "SAFE" position. See the firearm's owner's manual for detailed instructions.
3. Verify the silencer is at ambient temperature. If the silencer is hot, allow it to cool.

CAUTION! Never handle a hot silencer without heat-resistant gloves, as this may lead to skin burns and/or personal injury.

4. While firmly grasping the direct-thread mount, unscrew the silencer from the muzzle threads in the direction indicated in Figure 22.

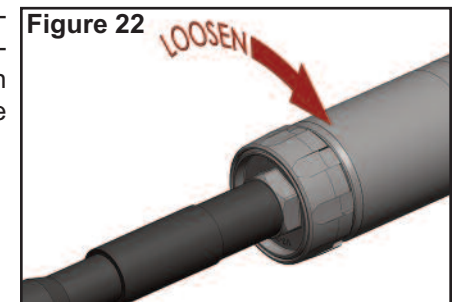

CLEANING THE RANGER SERIES

WARNING! Only perform cleaning and maintenance procedures on silencers that are not mounted to a firearm and are at ambient temperature. Attempting to clean or perform maintenance on a mounted silencer or hot silencers could lead to property damage, personal injury and/or death.

WARNING! Always wear protective gear, such as eye protection and solvent-resistant gloves when working with any solvent. Only use solvents in a well-ventilated area away from open flames. Unsafe use of

solvents may lead to property damage, personal injury and/or death.

1. If there is a fast-attach or direct thread mount installed, remove the mount following the instructions in this manual.
2. Remove the front-end cap from the silencer. See Figure 23.
3. Using a gun cleaning brush and solvent, thoroughly scrub the threaded socket and taper in the rear of the silencer. See Figure 24.
4. Using a gun cleaning brush and solvent, thoroughly scrub the threaded socket and taper in the front of the silencer. See Figure 25.
5. Clean the threads on the outside of the front-end cap. See Figure 26.
6. Clean the threads and taper on the outside of the fast-attach or direct thread mount. See Figure 27.
7. Apply a small amount of high temperature grease or anti-seize to the threads on the front-end cap and reinstall the front end cap in the front of the silencer.
8. Apply a small amount of high temperature grease or anti-seize to the threads and taper on the fast-attach or direct thread mount

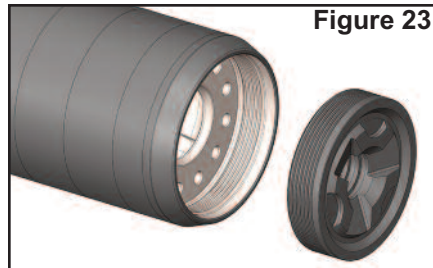

Figure 23

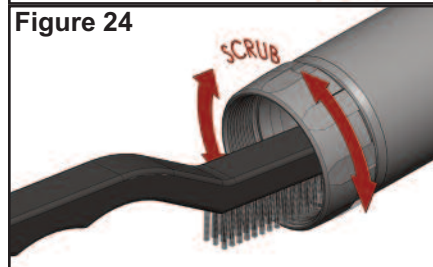

Figure 24

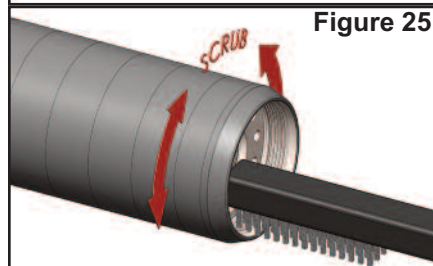

Figure 25

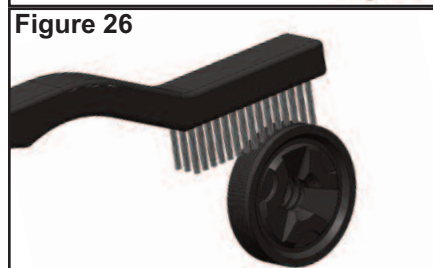

Figure 26



Figure 27

and reinstall the mount in the rear of the silencer.

9. Wipe off the exterior of the silencer with a clean cloth.