

READ THIS CAREFULLY BEFORE OPERATING THIS FIREARM

Stinger

**SAFETY AND
INSTRUCTION MANUAL**

BONDARMS^{INC.}

FACTORY SERVICING & ASSISTANCE:

For help and information or
should your Bond Arms handgun require factory service,
contact Bond Arms at (817) 573-4445 and describe the problem

or email customerservice@bondarms.com

**ALSO SEE OUR WARRANTY CARD
ON LAST PAGE OF THIS BOOKLET.**



P.O. Box 1296 • Granbury, TX 76048 • (817) 573-4445

WWW.BONDARMS.COM

SAFETY WARNINGS!

The safety warnings in this pamphlet are important. By understanding the dangers inherent in the use of any firearm, and by taking the precautions described herein, you can enjoy safety in the use of your new Bond Arms Firearm. Failure to heed any of these warnings may result in serious injury or death to you or others, as well as severe damage to the firearm or other property. Read and understand all the following precautions before removing this firearm from its package. This firearm is a precision instrument designed to function reliably with proper care and knowledgeable use. If you do not have a full understanding of the power and function of firearms, we recommend that you seek proper training. The Bond Arms Firearm incorporates safety features; however, SAFE HANDGUN HANDLING IS YOUR PERSONAL RESPONSIBILITY.

NOTICE OF LIABILITY

BOND ARMS, INC. shall not be responsible, either in whole or part, for injury, death, or damage to individuals or property resulting from intentional or accidental discharge of this firearm, or from its function when used for purposes or subjected to treatment for which it was not designed. BOND ARMS, INC. will not honor claims involving our firearms which result from careless or improper handling, unauthorized adjustment, after market modifications, **or reloaded ammo**, corrosion, neglect, or the use of wrong ammunition, bullets, or any combination of the above. At BOND ARMS' discretion claims made by a second or subsequent owner may or may not be honored.

SAFETY INSTRUCTIONS

1. Always keep safety on until ready to fire.
 2. Always wear eye and ear protection when firing any firearm.
 3. BEFORE handling any firearm, understand its operation.
 4. Always point your firearm in a safe direction.
NEVER point a firearm at another person or yourself.
 5. Always handle your firearm as though it were LOADED.
 6. Place your finger on the trigger ONLY when you are ready to fire.
 7. Always be certain that your target and the surrounding area are safe before firing.
 8. Always check to make sure the firearm is UNLOADED before passing it to or receiving it from another individual, and before storing it.
 9. Do not make any modifications to the firearm. Doing such will void the warranty.
 10. Never use firearms while under the influence of drugs or alcohol.
 11. NEVER leave a loaded firearm unattended.
 12. Discharging firearms in poorly ventilated areas, cleaning firearms, or handling ammunition may result in exposure to lead and other substances has been known to cause birth defects, reproductive harm and other serious physical injury. Have adequate ventilation at all times. Wash hands thoroughly after exposure.
 13. DO NOT rely on the safety to prevent accidental discharge. The safety **MAY NOT** prevent an accidental discharge due to dropping, jarring, or bumping a handgun.
- NOTE:** If your handgun is accidentally dropped and the impact was on the hammer, internal damage could have occurred. Please contact BOND ARMS at (817) 573-4445 for return or service instructions.

YOUTH HANDGUN SAFETY ACT

1. The misuse of handguns is a leading contributor to juvenile violence and fatalities.
2. Safely storing and securing firearms away from children will help prevent the possession of handguns by juveniles, stop accidents, and save lives.
3. Federal Law prohibits, except in certain limited circumstances, anyone under 18 years of age from knowingly possessing a handgun, or any person from selling, delivering, or otherwise transferring a handgun to a person under 18.
4. A knowing violation of the prohibition against selling, delivering, or otherwise transferring a handgun to a person under the age of 18 is, under certain circumstances, punishable by up to 10 years in prison.

FIRING SAFETY:

1. Always wear eye and ear protection when firing any handgun.
2. Always keep safety on until ready to fire.
3. When loading, unloading, or shooting do not put your hand or other body part in front of the barrel.
4. When firing, **do not place your fingers along the side of the barrel** or in front of the barrel.
5. Before firing, make sure that your firearm is in good working order and that the barrel is clear of dirt and obstructions.
6. If the firearm fails to fire a live round; engage safety, point in a safe direction, wait 30 seconds and then carefully unload it. **Now inspect the barrel for obstructions from the breech end.** If the bore is open, reload handgun, disengage the safety. Completing these steps, you can now fire the firearm.
7. Never cross obstacles such as fences or streams with a loaded firearm.
8. Never run with a loaded firearm.
9. Never shoot at a hard surface or hard, flat surface or over a liquid surface, such as water to avoid a ricochet and possible serious personal injury to yourself or a bystander.

AMMUNITION:

1. Always use clean, dry original factory made ammunition of the proper type and caliber for your firearm.
2. **Never use non-standard or reloaded ammunition.** Bond Arms, Inc. cannot be held responsible when faulty ammunition is used.
3. Your firearm has been designed for ammunition of a specific caliber. The proper caliber and cartridge type is indicated on the side of the barrel. Do not use any other ammunition than that specified on the barrel of your firearm. Do not alter the barrel, chamber, or caliber. **Do not use reloaded ammo.**
4. If you experience misfires or accuracy problems, try different brands of the same caliber ammo. Ammunition varies among manufacturers.

TRANSPORT AND STORAGE:

1. ALWAYS transport your firearm in the unloaded condition. ALWAYS carefully unload the firearm before entering a motor vehicle or a dwelling. NEVER load in the house or in your vehicle.
2. Obey all laws relating to the transportation of firearms.
3. Always store your unloaded firearm and ammunition separately and in places inaccessible to unauthorized persons.
4. Do not store your firearm in an air-tight container.
5. If your firearm is to be stored for an extended period, apply a thin layer of oil on the outside of the firearm. Do not spray oil down inside the firearm because some oils will dissolve the factory applied hammer grease.

OPERATING INSTRUCTIONS

USE OF CROSSBOLT SAFETY:

Safety Warning: Always keep fingers away from the muzzle and the firearm pointed in a safe direction. KEEP YOUR FINGER OFF THE TRIGGER.

To engage the safety to the “ON SAFE” position:

1. Grip the firearm with the muzzle pointing away from you.
2. Slide crossbolt safety to the LEFT side of the firearm, in front of the rebounding hammer.
3. Crossbolt safety will now block the hammer from reaching the firing pins. **This does not prevent the hammer from being cocked or released by a pull of the trigger.**

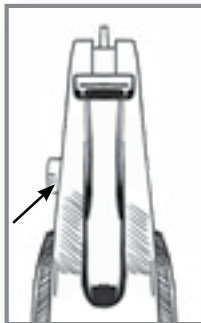

Safety in
“ON SAFE” Position



Safety in
“ON FIRE” Position

NOTE: Do Not intentionally release the hammer under full tension onto the crossbolt safety, or when there is not a barrel installed and locked into the frame by an engaged lock lever (often referred to as the barrel being “In-Battery”). Dry firing onto an engaged crossbolt safety or without a barrel In-Battery will damage the integrity of the firearm.

OPERATING INSTRUCTIONS (cont.)

To disengage the safety to the “ON FIRE” position:

1. Grip the firearm with the muzzle pointing away from you.
2. Slide crossbolt safety to the RIGHT side of the firearm.
3. Handgun is now ready to fire.

This Acts as an Effective Child Safety Device

1. Push crossbolt safety to the LEFT to the “ON SAFE” position.
2. Insert the Key (provided) in the Safety Locking Device (SLD) and turn clockwise until the SLD is jammed into the crossbolt safety. Then push the crossbolt safety to make sure it does not move. The Safety is now locked in the “ON SAFE” position.
3. To release the Safety, turn the Key counter clockwise until the crossbolt safety is unlocked.

1. **Push crossbolt safety to the LEFT to the “ON SAFE” position.**

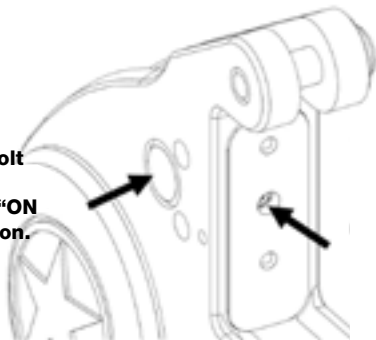

2. **Insert the allen wrench (provided on this page) in the Safety Locking Device (SLD) and turn clockwise until the SLD is jammed into the crossbolt safety. Then push the crossbolt safety to make sure it does not move. The Safety is now locked in the “ON SAFE” position.**

3. **To release the Safety, turn the Key counter clockwise until the crossbolt safety is unlocked.**

LOADING:

SAFETY WARNING: Hammer must be in the UNCOCKED position. Engage the manual cross-bolt safety by sliding the safety to the “ON SAFE” position, in front of the rebounding hammer. **KEEP YOUR FINGER OFF THE TRIGGER** while loading the firearm.

1. Ensure that the hammer is in the “UNCOCKED” position.
2. Push locking lever handle down and swing barrel away from frame.
3. Insert the proper cartridge for the barrel into each barrel.

Safety Warning: Use only factory loaded ammunition.

4. Carefully close the barrel by moving the barrel back to the frame and carefully close the handgun into the locked position **WHILE POINTING THE END OF THE BARREL AWAY FROM YOU AND OTHERS** in a safe direction.
5. Ensure that the lock lever has engaged and that the barrel is secure.
6. The locking lever handle should be parallel to the barrel.

SAFETY WARNING:

If your firearm is loaded with live ammunition and the hammer is in full cock but pulling the trigger does not release the hammer, engage the safety to the “ON SAFE” position. Take a 7/64” Allen wrench and remove the barrel from the frame. Once the barrel is removed from the frame, put the safety in the “ON FIRE” position and pull the trigger to release the hammer. Do not attempt to fire the firearm. Contact BOND ARMS, INC. at (817) 573-4445, M-F for troubleshooting advice.

FIRING:

Safety Warning:

ALWAYS engage the crossbolt safety in the “ON SAFE” position until you are ready to fire.
ALWAYS keep fingers away from the muzzle. ALWAYS point handgun in a safe direction.
ALWAYS wear hearing and eye protection.
DO NOT cock hammer until ready to fire. KEEP FINGER OFF trigger until ready to fire.

1. Pull back hammer to the full cock position and push the crossbolt safety to “ON FIRE” position.
2. Aim firearm at the target. Align the two sights and squeeze the trigger to fire.
3. Placing the index finger of the non-shooting hand on the front of the trigger guard (as in the Weaver hold) is NOT recommended. This type of hold may force the handgun to impact the knuckle on the middle finger of the shooting hand if shooting heavy recoiling calibers.
4. The Bond Arms Stinger is a short range handgun. Effective range is from 1 to 21 feet. Because the barrels are at different distances from the top of the shooting hand, the bullet fired from the top barrel will diverge from the bullet fired from the bottom barrel.

The sites of the handgun are lined up for the bottom barrel.

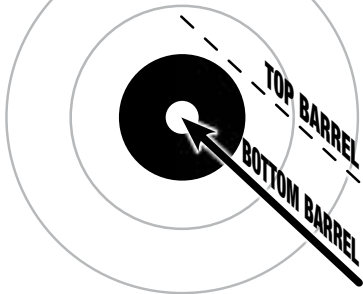

FIRING:

What do I do if hammer is cocked, handgun is loaded, but no amount of pulling the trigger will release the hammer?

Make sure your firearm is POINTED IN A SAFE DIRECTION. If your firearm is loaded with live ammunition and the hammer is in full cock but pulling the trigger does not release the hammer, engage the safety to the “ON SAFE” position. Take a 7/64” Allen wrench and remove the barrel from the frame. Once the barrel is removed from the frame, put the safety in the “ON FIRE” position and pull the trigger to release the hammer. Do not attempt to fire the firearm. Contact BOND ARMS, INC. at (817) 573-4445, M-F for troubleshooting advice.

FIRING:

Trigger Pull:

The trigger pull is approximately between 6 and 7 pounds, which is within the acceptable range for a handgun of this type. Derringers, being small compact handguns, require the user to operate the handgun in a specific manner.

1. With the hammer in the full cock position, grasp the grip with your shooting hand making sure that your hand is NOT touching the cocked hammer. Any amount of pressure applied to the cocked hammer by your hand will increase the trigger pull substantially.
2. Make contact with the trigger using the pad of your trigger finger. Avoid pulling the trigger with the bend of your first knuckle.
3. Pull the trigger downward and back.
4. Trigger pull gets better with usage.

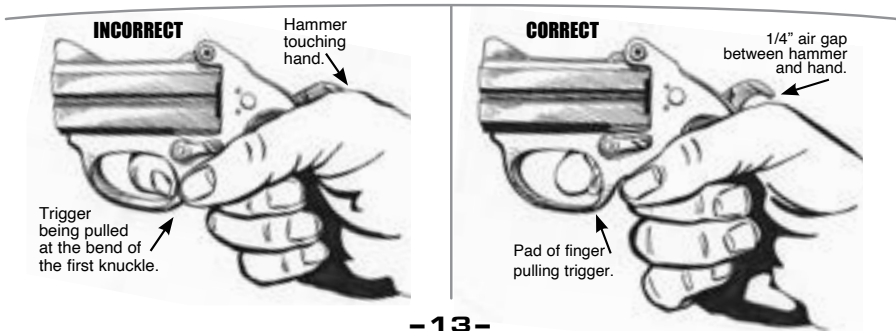

UNLOADING:

Safety Warning: *Always point the firearm in a safe direction.*

1. Ensure that the crossbolt safety is in the "ON SAFE" position.
2. Check that the hammer is in the uncocked position. If necessary, hold the hammer with your thumb and release the trigger. Gently let the hammer slide to the uncocked position while the safety is on.
3. Push lock lever handle down and swing barrel away from frame.
4. Remove spent cartridge cases from the barrel breech. Slide extractor away from the barrel to eject cases if necessary. (Barrels for rimless rounds, such as 9mm do not have an extractor. There is a clearance cut in the breech of the barrel to allow the shooter to extract the rounds with a fingernail or rim of a fired casing.)
5. Close barrel by moving barrel back to frame and ensure that the lock lever has engaged.

INTERCHANGEABLE BARRELS:

Safety Warning: Ensure that your handgun is UNLOADED.

NOTE: With the barrel locked into the frame, notice the position of the lock lever handle. When the new barrel is locked in the frame this lever handle should be in approximately the same position. Locking lever handle should be approximately parallel to the barrel.

Contact BOND ARMS, INC. at (817) 573-4445, M-F for troubleshooting advice.

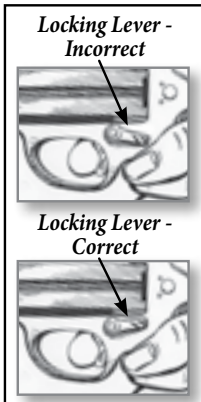

UNLOADING:

REMOVING AND INSTALLING BARRELS:

1. Push lock lever handle down and swing barrel away from frame.
2. Loosen and remove barrel hinge screw with 7/64" Allen wrench (not provided.) Barrel can now be removed from the firearm's frame.
3. Align the hinge hole of the barrel to be installed with the hinge hole in the frame. Slip barrel hinge screw through the frame and barrel hinge hole.
4. Use 7/64" Allen wrench and tighten the screw until it bottoms out and cannot be turned. **DO NOT OVERTIGHTEN THIS SCREW. DAMAGE TO THE SCREW COULD OCCUR.**
5. Close the barrel by swinging the barrel back to the frame. Check lock lever handle position as explained in NOTE above in this section.

*Remove &
Install Barrel
with Allen Wrench*



SAFETY CHECK FOR NEW BARREL:

6. **KEEP THE HANDGUN POINTED IN A SAFE DIRECTION.** With barrel locked into the frame and with the handgun **UNLOADED**, pull the hammer back and pull the trigger so the hammer goes forward. If the hammer does not go forward, remove the barrel from the frame and call BOND ARMS, INC. at (817) 573-4445 before using.

UNLOADING:

CHANGING GRIPS:

BOND ARMS, INC. has a wide variety of custom grips available for your handgun. When changing the grips, you must first make sure that the handgun is unloaded and pointed in a safe direction. Pull the hammer to the full cock position. Use the proper screwdriver to remove the grip screw of the existing grips. Install the new grips. Pull the trigger to release the hammer from the full cock position, while still pointed in a safe direction. Some fitting of the new grips may be required (do not modify the frame or other parts of the firearm). **Large frame grips and extended grips will not fit Stinger frame.**

MAINTENANCE AND CLEANING:

Safety Warning: Ensure that your firearm is not loaded.

After each shooting, clean the barrel bore from the rear (breech end) with a bore cleaning solvent and cotton patches or a brass bore brush. Never clean the barrel from the muzzle and do not use steel brushes. Use a suitable cleaning rod. When bore is clean, push a lightly oiled patch through the bore. After each use, wipe all external metal surfaces with a lightly oiled cloth.

NOTE: Keep the hammer area inside of the frame free of dirt and other foreign matter. Failure to do so may render the rebounding hammer inoperative. DO NOT spray oil down inside the handgun because some oils will dissolve the factory applied hammer grease resulting in an increase in trigger pull.

Do not disassemble the flipper from the locking lever. Improper reassembly of the flipper to the locking lever could disable the rebounding hammer feature and make the firearm unsafe.

SERVICING:

Periodically check your firearm for dirt and other foreign matter. Check for grit in the hammer action, barrel locking mechanism, cartridge extractor, and crossbolt safety.

Bond Arms recommends replacing the Hammer Spring approximately every 1,500 cycles of the hammer to maintain reliable ignition.

Should your Bond Arms Stinger require factory service, contact Bond Arms at (817) 573-4445 and describe the problem.

****Do not send in handgun without first calling us for an RMA.***

For help and information contact:
BOND ARMS
(817) 573-4445
customer.service@bondarms.com
bondarms.com

WARNING!

This product Contains Lead From Test Firing. Wash hands after handling handgun.

| Item | Qty | Part Name | Item | Qty | Part Name |
|------|-----|---------------------------------------|------|--------|--|
| 1 | 1 | Hammer | 21 | 1 | Extractor (See statement below) |
| 2 | 1 | Top Spring Guide | 22 | 1 | Extractor Spring (See statement below) |
| 3 | 1 | Hammer Spring | 23 | 1 | Barrel |
| 4 | 1 | Bottom Spring Guide | 24 | 1 | Breech Plate |
| 5 | 1 | Selector Cam | 25 | 1 | Breech Plate Pin |
| 6 | 1 | Hammer Pin | 26 | 1 | Lock Lever Screw |
| 7 | 1 | Torsion Spring | 27 | 1 | Lock Lever Flipper |
| 8 | 1 | Extractor Conical Spring | 28 | 1 | Lock Lever Shaft |
| 9 | 1 | Extractor Head Spring | 29 | 1 | Lock Lever Spring |
| 10 | 1 | Hammer Head | 30 | 1 | Trigger |
| 11 | 1 | Bottom Firing Pin | 31 | 1 | Trigger Spring |
| 12 | 2 | Firing Pin Spring | 32 | 2 | Trigger Screw |
| 13 | 1 | Top Firing Pin | 33 | 1 | Selector Screw |
| 14 | 2 | Firing Retaining Pin | 34 | 2 | Selector Flat Spring |
| 15 | 1 | Safety Spring | 35 | 1 | Selector Nut |
| 16 | 1 | Safety Detent | 36 | 1 Pair | Grips |
| 17 | 1 | Safety | 37 | 1 | Grip Screw |
| 18 | 1 | Safety Retaining Screw | 38 | 1 | Frame |
| 19 | 1 | Barrel Hinge Screw | 39 | 1 | Grip Threaded Insert |
| 20 | 1 | Extractor Screw (See statement below) | 40 | 1 | Hammer Head Pin |

(Numbers 20, 21 & 22: Extractor, Extractor Screw and Extractor Spring not included on these calibers of Bond Stinger Handguns... 9mm or .380 acp)

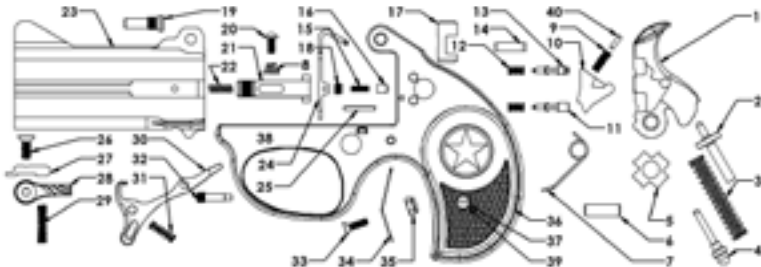

QUESTIONS:

Which chamber fires first?

The hammer alternates between the top and bottom firing pins each time the hammer is cocked. There is no manually operated switch on the handgun which allows you to select the top or the bottom chamber to fire.

But you can pre-select the chamber you wish to fire by doing the following:

When the firearm is unloaded, cock the hammer back and you will see a separate piece of metal and a spring on the left side of the Hammer when the handgun is held in a firing position. This piece of metal is the hammer head and each time you cock the hammer the hammer head will raise one time and then drop the next. Note the position of the hammer head and if it is in the lower position then the bottom barrel will fire next. If the hammer head stays in the top position then the top barrel will fire next. After cocking and using your thumb to release the hammer several times you will see the movement of the hammer head.

TOP barrel will fire when like this.

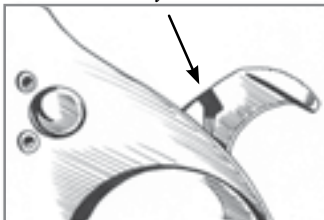

BOTTOM barrel will fire when like this.

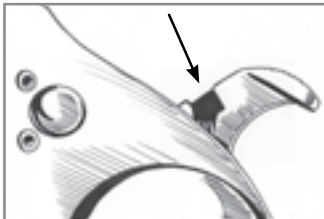

QUESTIONS:

Does Bond Arms build a barrel that shoots two different CALIBERS, such as 9mm and .38 Special?
NO.

What is the rebounding hammer?

Think of the rebounding hammer as an automatic half cock. The hammer automatically rebounds to a blocked position off of the firing pins. This allows for safer reloading compared to other derringers. The rebounding hammer is an exclusive patented feature for the Bond Stinger. The crossbolt safety should be able to move between positions in front of the rebounding hammer. Contact BOND ARMS, INC. at (817) 573-4445, M-F for troubleshooting advice.

Will barrels from the existing large bore Bond derringer platform fit on the Bond Stinger derringer?

NO. Centerfire Bond Stinger barrels are their own platform, but are interchangeable with other centerfire Bond Stinger barrels.

Is it okay to dry fire on the manual crossbolt safety in the “ON SAFE” position?

NO. The crossbolt safety should be used as an emergency device to keep the firearm from firing unintentionally. It can be harmful to the firearm to repeatedly snap the hammer down on the crossbolt safety.

*Rebounding Hammer
NORMAL Half-Cock
Position*

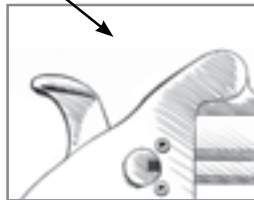

*Rebounding Hammer
FIRING Position*

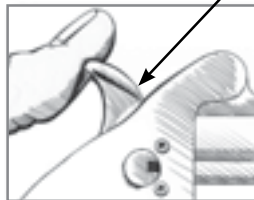

QUESTIONS:

Is it okay to dry fire the handgun with the manual safety in the “ON FIRE” position?

NO. It is okay to dry fire the handgun with fired casings in place of live ammo and with a barrel installed and locked into the frame by an engaged lock lever (often referred to as the barrel being “In-Battery”).

Is it okay to carry the Bond Stinger cocked and locked as is sometimes done with the 1911 style semiautomatic handgun?

NO. This is very unsafe.

WARRANTY:

YOUR PURCHASE RECORD

RECORD YOUR SERIAL NUMBER HERE AND KEEP THIS BOOKLET WITH
YOUR HANDGUN CASE FOR YOUR CONVENIENCE.

Name of Owner _____

Address _____

City _____ State _____ Zip _____

Contact Phone No. _____

Email Address _____

Model _____ Caliber _____

Serial No. _____

Where Purchased _____

Date of Purchase _____

WARRANTY:

IMPORTANT! WARRANTY INFORMATION!
MUST BE FILLED OUT WITHIN 30 DAYS OF PURCHASE!!

Purchaser or Product Owner:

REQUIRED Name: _____

REQUIRED Phone: _____

REQUIRED Email: _____

REQUIRED Address: _____

Your Gun Information

REQUIRED Serial Number: _____

REQUIRED Gun Model: _____

Store or Dealer where Purchased:

Name: _____

City & State: _____

Phone: _____

Comments or Testimonials:

How did you hear about our product:

- Word of Mouth In Store Display
 Radio Ad Magazine Ad
 Gun Show Website

(Check all that apply)

- American Handgunner
 American Rifleman (NRA)
 America's 1st Freedom (NRA)
 Bass Pro Outdoor World
 Blue Press
 Cabela's Outfit Journal
 Cowboy Chronicle (SASS)
 Farm & Ranch Connection
 Guns
 Guns & Ammo
 Gun Digest
 Guns of Old West
 Handguns
 Nations Best Sports Fish & Hunt
 Outdoors
 Shoot! Magazine
 Shooter's Bible
 Shooting Sports (NRA)
 Shooting Times
 TV
 Other

**Detach this page,
place in an envelope and mail to:**

BOND ARMS, INC.

P.O. Box 1296

Granbury, Texas 76048

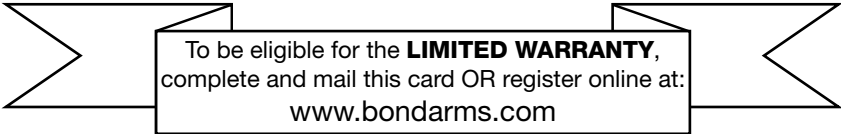

To be eligible for the **LIMITED WARRANTY**,
complete and mail this card OR register online at:
www.bondarms.com