

AMERICAN WESTERN ARMS

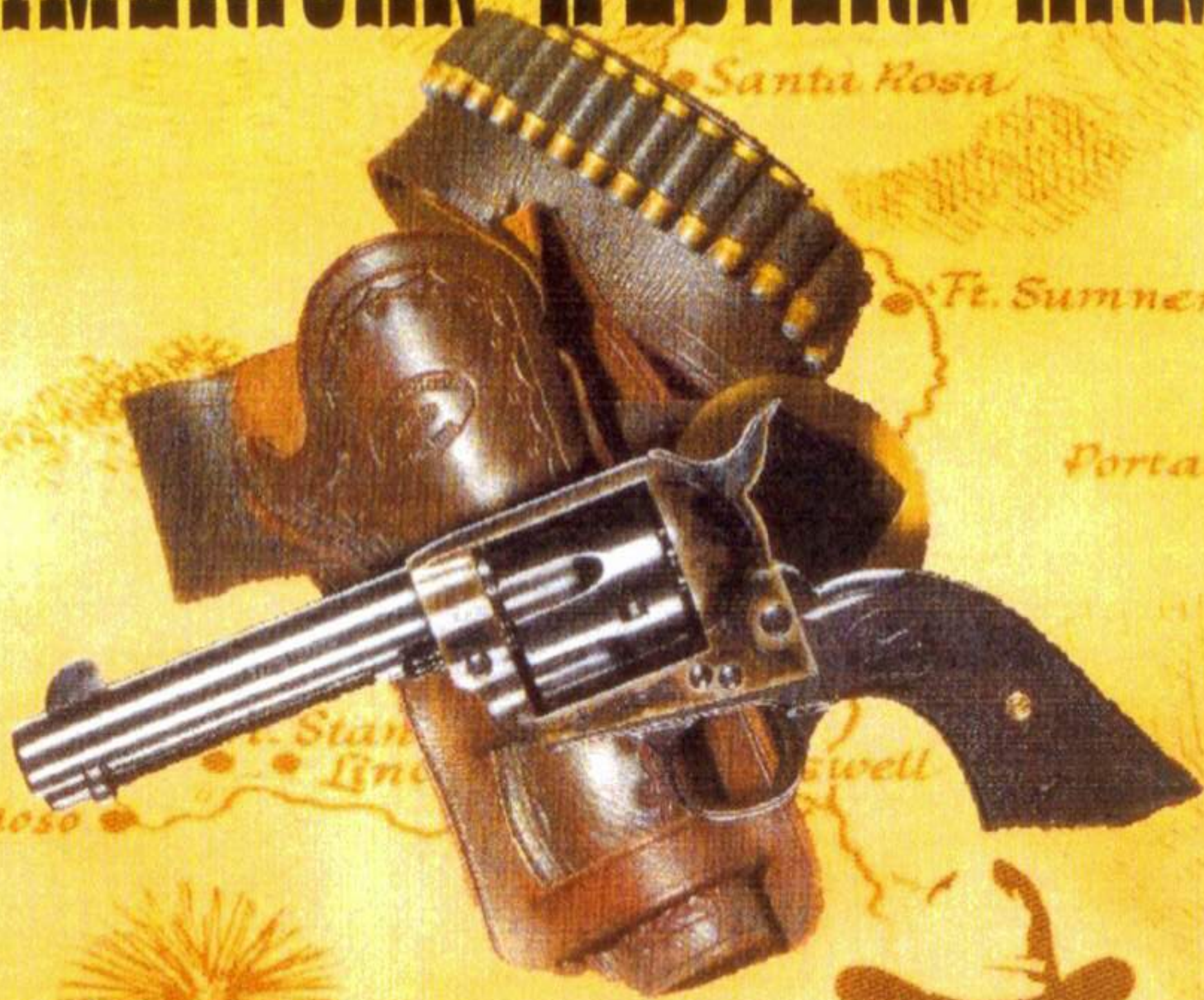

AWA International, Inc.
SAFETY AND INSTRUCTION MANUAL
for
Single Action 1873 Revolvers

Copyright 2002© AWA International, Inc. (DBA American Western Arms). All rights reserved. This instruction manual should always accompany the Firearm it was delivered with.



TABLE OF CONTENTS

	Page
Basic Safety Rules	1 - 3
Safe Storage & Transportation	4 - 5
Warranty	5 - 6
General Information	6 - 9
Contents of Box	10
Ammunition	10
Handling	11
Loading & Unloading	11-12
Care & Cleaning	12-13
Remove/Replace Cylinder	12-13
Disassembly & Reassembly	13-14
Service	14-15
Parts & Accessories	16-17

BASIC SAFETY RULES

- 1.) Treat all firearms as if they were loaded!
- 2.) Do not point at or cover anything with the muzzle until ready to shoot!
- 3.) Keep trigger finger off the trigger and outside the trigger guard until ready to shoot!
- 4.) Be certain of your target and your line of fire!

Safe and secure storage of your firearm is one of your most important responsibilities. It is a full-time responsibility. You must always secure your firearm and ammunition so that they are not accessible to children or other unauthorized persons.

AWA has provided a gunlock for use with your firearm. There are a variety of other locks and safe storage containers available in the marketplace, which may be appropriate for your particular needs. By purchasing a firearm you have taken on the responsibility of safely securing the firearm at all times and preventing its unauthorized use. your personal responsibility to select and use whatever devices or practices will enable you to safely secure your firearm at all times.

- Before handling any firearm, understand its operation. Not all firearms are the same. Familiarize yourself with the mechanical features of any firearm you intend to use. If you feel uncertain about any operational aspects of your handgun, please contact American Western Arms at 877-292-4867 before proceeding with its operation.
- Always safely store and secure your firearm. Safe and secure storage of your firearm is one of the most important responsibilities of firearms ownership. It is a full-time responsibility. You must always secure your firearm and ammunition separately so that they are not accessible to children or other unauthorized persons.
- Always treat every firearm as if it were loaded and would fire if the trigger is pulled. Do not take anyone's word that the firearm is unloaded – always check for yourself. Never pass your firearm to another person until the cylinder or action is open and you visually check that it is unloaded. Keep your firearm unloaded and safely stored when not in use.
- Always keep your firearm pointed in a safe direction. Never point a firearm at anyone or anything you do not intend to shoot whether or not it is loaded. This is particularly important when loading, unloading, or field stripping the firearm. Always control the direction of the firearm.
- Never place your finger inside the trigger guard unless you intend to fire. Your firearm cannot fire unless the trigger is pulled. Ensure that other objects do not touch the trigger.
- Always be sure of your target and what is beyond it. Always be sure of where the bullet will strike and shoot only where there is a safe backstop free of obstructions, what or other surfaces can cause ricochets. Do not fire into the sky.
- Never carry or store a firearm with the hammer in the cocked position.

TABLE OF CONTENTS

	Page
Basic Safety Rules	1 - 3
Safe Storage & Transportation	4 - 5
Warranty	5 - 6
General Information	6 - 9
Contents of Box	10
Ammunition	10
Handling	11
Loading & Unloading	11-12
Care & Cleaning	12-13
Remove/Replace Cylinder	12-13
Disassembly & Reassembly	13-14
Service	14-15
Parts & Accessories	16-17

BASIC SAFETY RULES

- 1.) Treat all firearms as if they were loaded!
- 2.) Do not point at or cover anything with the muzzle until ready to shoot!
- 3.) Keep trigger finger off the trigger and outside the trigger guard until ready to shoot!
- 4.) Be certain of your target and your line of fire!

Safe and secure storage of your firearm is one of your most important responsibilities. It is a full-time responsibility. You must always secure your firearm and ammunition so that they are not accessible to children or other unauthorized persons.

! Warning

Safe and secure storage of your firearm is one of the most important rules of firearm safety. Your failure to follow these rules may result in serious injury or death.

- You must always secure your firearm and ammunition separately so that they are not accessible to children or other unauthorized persons.
- Safe and secure storage and transportation of your firearm are your responsibility. It is a full-time responsibility.
- Always store your firearm unloaded. Your firearm and ammunition should be stored separately in places and in a manner inaccessible to children and unauthorized persons.
- American Western Arms has provided a lock for use with your firearm. Do not use a lock on a loaded handgun and never load a locked handgun.
- Never assume that a hiding place is a secure storage method. Others may be aware of your storage location or come upon it by chance. It is your personal responsibility to use common sense when storing and securing your firearm and ammunition and to always make sure that it is not accessible to children or other unauthorized persons.
- Follow the law. You must be familiar with all local, state, and federal laws regarding the safe storage and transportation of your firearm. Failure to know and follow the law may result in unauthorized access or use of your firearm by another. Obey all laws relating to the storage and transportation of firearms.
- Never transport a loaded firearm. When transporting your firearm, be sure that the cylinder or action is open.
- Your local police department or gun shop will furnish you with available information on storing and/or transporting a firearm legally in your state.
- Your firearm is your responsibility. Protect your firearm from theft or misuse by untrained or unqualified individuals.

Maintenance Before Storage

When storing, do not encase your firearm in anything that will attract or hold moisture. For example, leather or heavy cloth. Also, do not store guns with a plug inserted in the barrel for this can be a contributing factor to moisture accumulation. If your firearm is to be stored for an extended period, the bore, chambers and internal working mechanism should be oiled with acid-free lubricating oil or preservative, and the external working mechanisms, frame cylinder and barrel should be coated with anti-rust oil. Before using your firearm again, be sure to clean it. Every time you clean your firearm, check it for signs of wear. If wear is noted, do not use the firearm. Return it to American Western Arms for service have it checked by a qualified gunsmith.

Maintenance Before Use

Before using your firearm, it should be cleaned, and all screws are tight. Your firearm has been treated with either a preservative or oil to protect against corrosion. Before using it, all excess oil should be wiped from the bore, chambers and exposed areas using a clean swab or patch. A light coat of high quality gun oil should be applied to the outside surfaces and mechanism. Care should be taken not to oil the mechanism to the degree that the oil may trap dust and lint.

Shooting Fundamentals

- 1.) Learn the Fundamentals
- 2.) Select Your Firearm
- 3.) Choose the Right Ammunition
- 4.) Develop Marksmanship

WARRANTY

IMPORTANT WARRANTY NOTICE

The American Western Arms' warranty permits ONLY the use of factory loaded "Cowboy" ammunition. The use of any hand-loaded or non-commercially manufactured ammunition voids all AWA warranty coverage!

Based on Magnuson-Moss Warranty Act, AWA offers no express warranty on its product line. However, AWA recognizes its obligations concerning implied warranty. AWA also stands behind its products as always, and will continue to provide services to its product line as it has over the years. AWA products will be serviced for a period of one year from the date of retail purchase, for defects in workmanship or materials at no charge to the purchaser. Be sure to retain you sales slip as proof of purchase date when making a warranty claim.

GENERAL INFORMATION

The AWA Single Action revolver models, Longhorn, Peacekeeper, and 1873 are covered by this manual.

Caliber Options	Barrel Length	Finishes	Sights
32-20, 38/357, 38-40, 44-40, 44spec, 45colt	3", 3.5", 4.75" 5.5", 7.5"	Blue, CCH, Polished Nickel, Polished Chrome, Hard Chrome, Teflon®	"V" Notch, Action "U" Notch

Figure 1

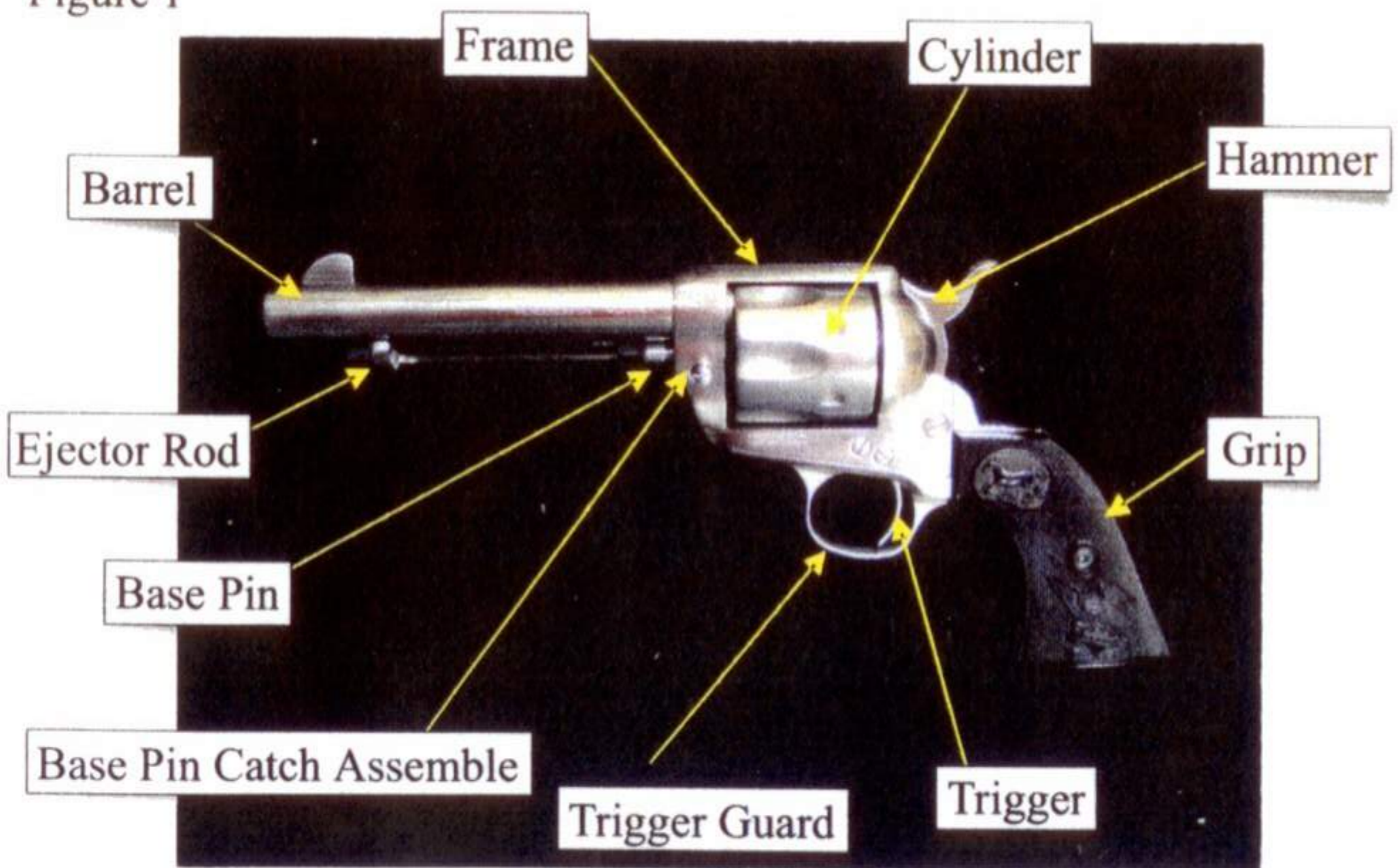

! WARNING – This revolver has been recreated from a historic design and is extremely dangerous to handle when loaded.

Owners of fine firearms such as the AWA revolver should be aware that:

- 1.) Loading and unloading the firearm will show wear and lead to loss of value.
- 2.) Excessive handling will lead to premature wear and cause loss of value.
- 3.) Firing this revolver will cause immediate and extreme loss of value.

Read and understand all the following precautions before removing this firearm from its packaging.

This AWA product is classified by the Bureau of Alcohol, Tobacco and Firearms as a firearm or dangerous weapon; it is, therefore, potentially lethal!

! WARNING – If this firearm is carelessly or improperly handled, unintentional discharge could result and could cause injury, death or damage to property.

Before it left our facility, this firearm was tested, carefully inspected, and packaged. AWA cannot control product handling after it leaves the factory. Please examine this firearm carefully at the time of purchase to ensure that it is unloaded and undamaged. The dealer will be pleased to assist you in making this examination and endeavor to answer any further questions you may have.

This instruction manual should always accompany this firearm and be transferred with it upon change of ownership.

! WARNING – If you make unauthorized adjustments or use unauthorized parts, AWA will not assume responsibility for the function of the revolver.

This gun is manufactured to perform properly with the original parts as designed. It is your responsibility to make sure any parts you buy are installed correctly and that neither replacements nor originals are altered or changed. Your gun is a complex tool with many parts that must relate correctly to other parts. Putting a gun together wrong or with modified parts can result in a damaged gun, injury or death to you and others through malfunction. Always let a qualified/authorized gunsmith work on your gun.

! CAUTION – Make sure that your firearm is not loaded.

- 1.) Write letter explaining the problem and your requirements in as much detail as possible. Include the model name and serial number. Include your return address, phone number and email address.
- 2.) Ship your gun only in a proper shipping container or box. Damage can result when your firearm is shipped incorrectly.
- 3.) Do not send manual, lock, or any accessories, or ammunition unless asked.
- 4.) Ship your firearm only with a Return Authorization marked clearly on the box. Call 1-877-292-4867 extension 103 for a Return Authorization number.
- 5.) AWA's shipping address:
AWA
1450 SW 10th St. 3B
Delray Beach, FL 33444
561-330-0556 ext. 103
- 6.) Insure package contents against damage, loss or theft.

WARNING

Ensure firearm is empty before handling. Before handling of this or any firearm.

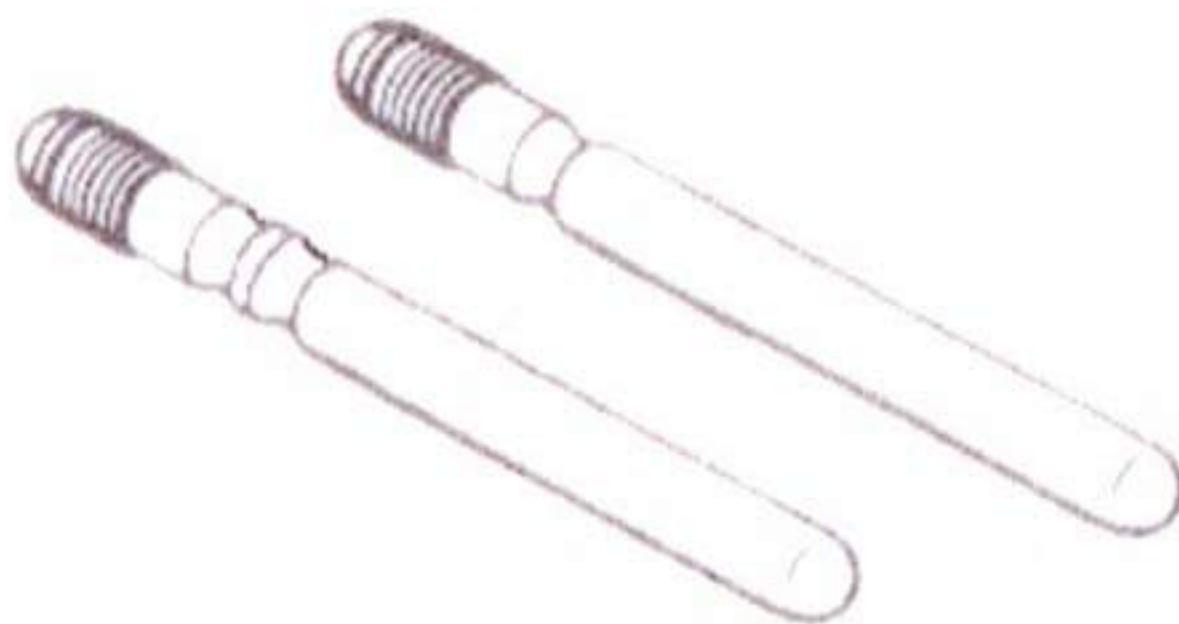

Above are the two styles of base pins. The safety style (left with two notches) that comes with the firearm and the original style (right with one notch) that does not come with the firearm but is available by calling AWA at 1-561-330-0556.

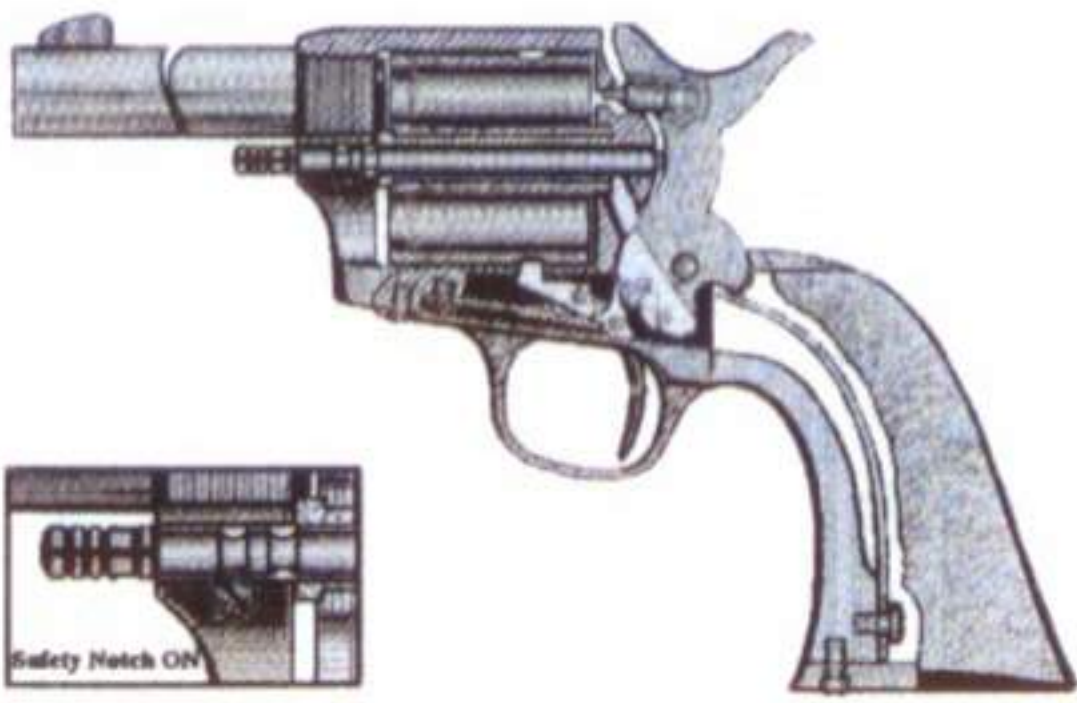

“SAFETY” Position

This position is when you are **NOT** firing or dry firing this firearm. **Note:** If fired in this position it may cause the base pin to walk forward and damage the base pin and/or base pin catch assembly.

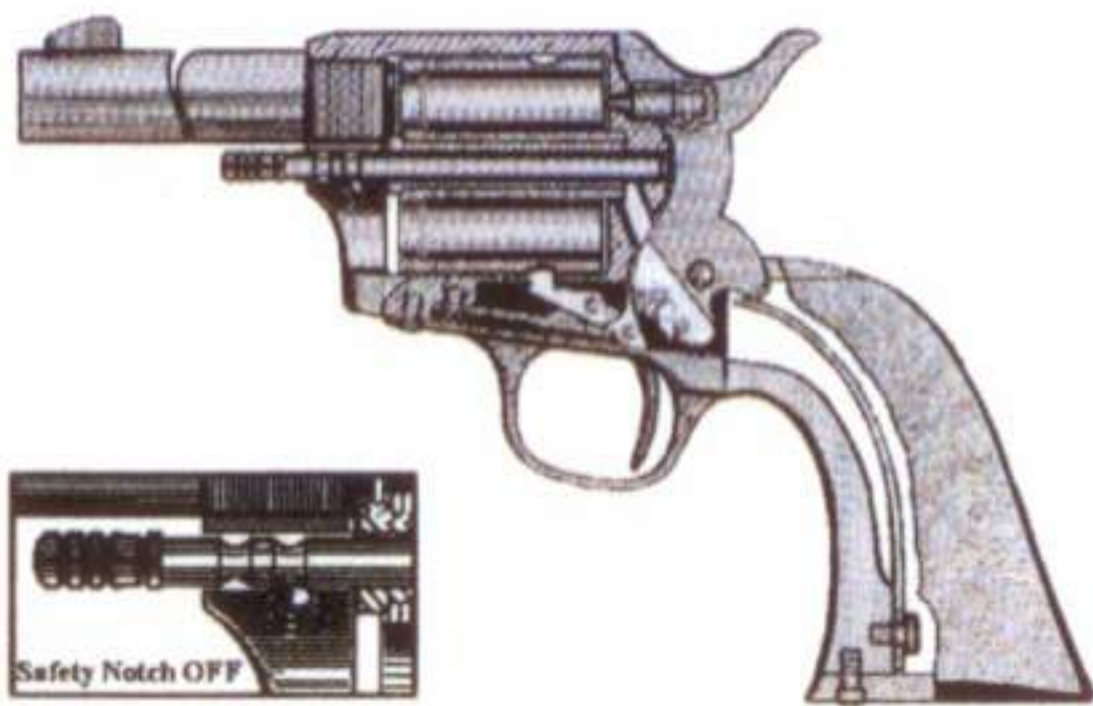

“FIRING” Position

This position is when you are **ready to fire**. This is also the position for dry firing. **Note:** Read the safety manual for safe loading and unloading of this firearm before you go to the range.

Additional safety features of your AWA single action revolver, when properly employed, can minimize the risk of accidental discharge. The Trigger Guard is designed to protect the trigger mechanism from accidentally being released. Also, there are three precision cuts in the hammer which serve to help prevent the firing pin from moving into the frame. The trigger cannot be moved unless enough force is applied to break it and/or the notch.

! CAUTION - Always carry your AWA single action revolver with an empty chamber in front of the hammer. Here's a tip, load one round, skip the next chamber and load the next 4. The hammer will be lowered on the empty chamber. Never carry your revolver in the Half Cock hammer position since accidental discharge may be possible.

! CAUTION - Always pull the hammer all the way back and then lower. **DO NOT** lower the hammer from the half-cock position! If you do, you may severely scratch the cylinder.

Figure 2

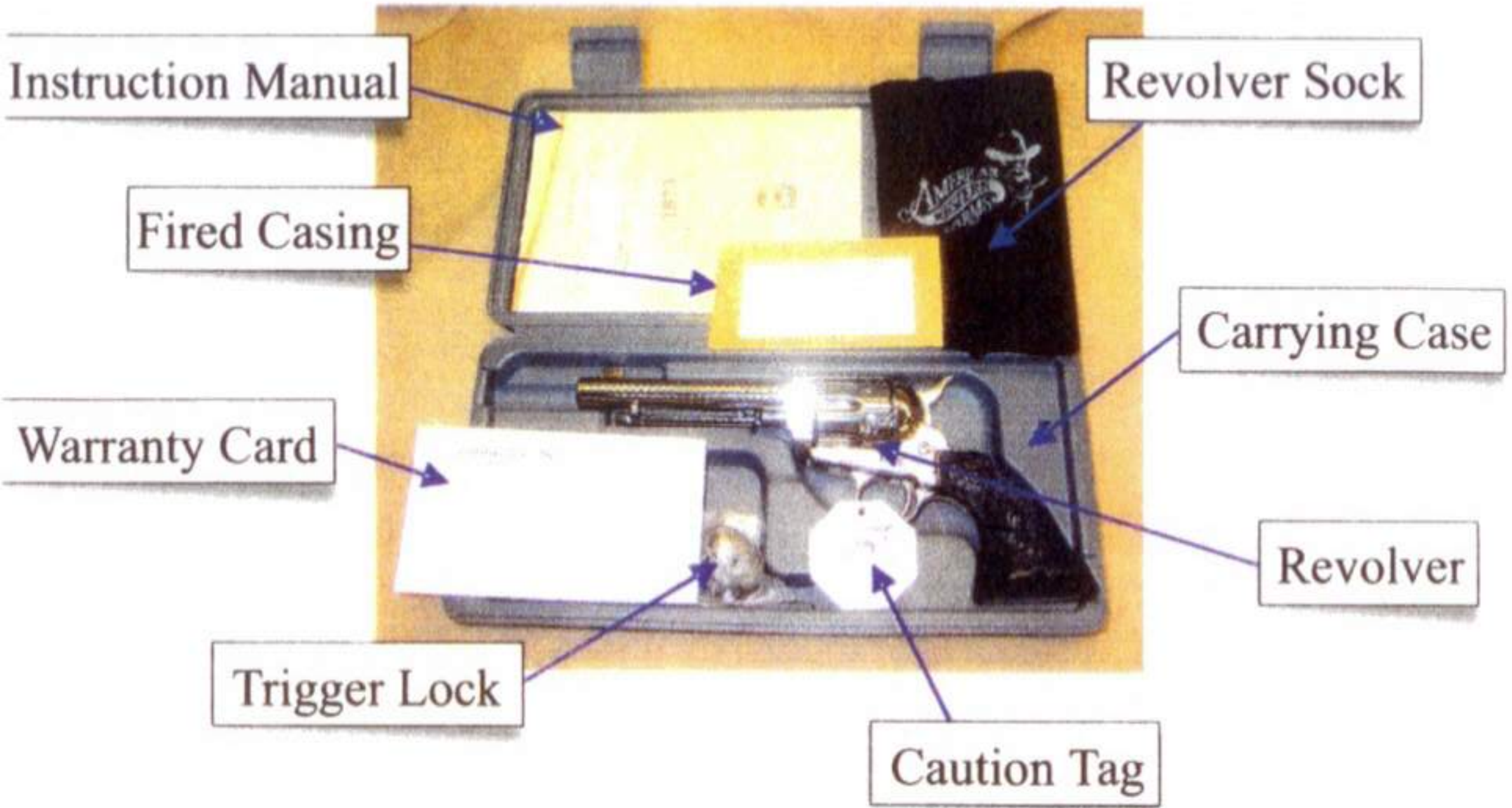

Your AWA revolver should have the above listed items in the box. If it does not, please contact our Customer Service Department at 877-292-4867 X 100.

AMMUNITION

! WARNING – If you decide to fire this revolver, use only original, high quality commercially manufactured “cowboy” ammunition in good condition. Use only ammunition appropriate to the caliber of your revolver. See Figure 3

<i>Revolver Chamber Size</i>	<i>Suitable Ammunition</i>					
	.32-20	.38 Special	.38-40	.44 Special	.44-40	.45 Colt
.32-20	YES	NO	NO	NO	NO	NO
.38 Special	NO	YES	NO	NO	NO	NO
.38-40	NO	NO	YES	NO	NO	NO
.44 Special	NO	NO	NO	YES	NO	NO
.44-40	NO	NO	NO	NO	YES	NO
.45 Colt	NO	NO	NO	NO	NO	YES

! WARNING - Always point the revolver in a safe direction. This means down range! Do not full cock the hammer until you are ready to fire.

HANDLING

This is a “Single Action” revolver. The hammer must be manually drawn, completely, rearward or cocked before firing each shot.

Cocking



- 1.) First Cock Position – This is the first click you hear when pulling the hammer toward the rear. This is considered a basic safety position.
- 2.) Half Cock Position – The next click you hear is the half cock engaging. This is the hammer position where loading and unloading your revolver takes place. In this position, the cylinder is disengaged from the bolt and the cylinder is allowed to spin clockwise.
- 3.) Full Cock Position – Full cock means you are ready to fire your revolver.

Decocking

- 1.) Make sure your revolver is pointed downrange.
- 2.) Fully draw the hammer back with your thumb and hold it there firmly. At the same time, pull the trigger rearward.
- 3.) Slowly lower the hammer as you are pointing the revolver downrange and holding the trigger rearward. Always assume you are lowering the hammer onto a live primer!

! WARNING - Always lower hammer on an empty chamber. Never lower hammer/firing pin on a loaded round or live primer. Always point revolver in a safe direction.

LOADING & UNLOADING

Loading

Holding your AWA single action revolver in your left hand, with the muzzle pointed down; bring the hammer to half-cock. Open the gate with your right hand. You should be able to move the cylinder with your thumb and fingers clockwise. Insert each correct caliber cartridge, only loading 5 chambers. Close the gate.

! WARNING - Always point the revolver in a safe direction. This means down range! Do not full cock the hammer until you are ready to fire.

Unloading

- 1.) Draw the hammer back to its half cock position and open the gate on the right side of the frame.
- 2.) Push out each cartridge or empty case with the ejector rod located under the barrel. Operate the ejector rod in each chamber to its full length to assure full length case ejection.
- 3.) Check to be sure that all cartridges or brass have been removed from the cylinder, and then close the gate.

! WARNING – Do not eject unfired cartridges onto any surface where the cartridge primer might strike a solid object and discharge.

Dry Firing

! CAUTION – do not snap the hammer of your revolver on an empty chamber. The solid firing pin may fracture and you could damage the firing pin hole in the frame.

When dry firing use snap caps, or safe training rounds (dummies) with a firing pin protection device system. This will prevent stress breakage.

! WARNING - Damage can occur to the cylinder finish if the cylinder is allowed to hit the frame during removal or replacement. Also, if the hammer is not in the half cock position the bolt will not allow the cylinder to be removed.

Remove the cylinder using the following steps:

- 1.) Point revolver in a safe downward direction.
- 2.) Open the loading gate on the right side of the frame.
- 3.) Pull hammer back to half cock notch.
- 4.) Rotate cylinder to check each chamber for brass or live cartridges. Remove any brass or live cartridges.
- 5.) Depress the base pin catch. This is the spring loaded plunger system located on the left side of the frame. Keep it depressed.
- 6.) Slide the base pin all the way out. The base pin is the heavy pin around which the cylinder rotates.
- 7.) Remove cylinder toward the loading gate. The cylinder is precisely made to fit your revolver. It can be removed and replaced easily.

Use a wood, aluminum or brass cleaning rod (not steel), a brass bristle brush and patches appropriate to your revolver's caliber. Use a good quality cleaning solution to swab the bore and each chamber. Always brush all the way through the bore. Never try to reverse direction while the brush is inside the barrel of chamber. Swab the bore and chambers after you brush. After swabbing, run clean patches through the bore and chambers until the patches come out clean. Then, completely but lightly, oil the entire revolver.

! CAUTION – Firing a revolver with oil, grease, or any other material even partially obstructing the bore may result in damage to the revolver and serious injury to the shooter and those nearby. Do not spray or apply lubricants directly on ammunition. If the lubricant affects the powder charge or a cartridge, it may not be ignited, but the energy from the primer may be enough to push the bullet into the bore where it may become lodged. Firing a subsequent bullet into the obstructed bore may damage the revolver and cause serious injury or death to the shooter and those nearby. Use lubricants properly. You are responsible for the proper care and maintenance of your firearm.

DISASSEMBLY AND REASSEMBLY

To disassemble your AWA revolver, follow the instructions for removing the cylinder. To disassemble your revolver further, see the following instructions:

- 1.) Ejector - unscrew the ejector tube screw, then push the front end away from the barrel and pull it towards the muzzle.
- 2.) Grips – the grips can be removed by unscrewing the two screws just behind the hammer at the bottom of the strap. The trigger guard can be removed by disengaging the mainspring and unscrewing the screws located near the trigger and at the front of the trigger guard. All parts of the lock are then displayed and can be readily cleaned.
- 3.) Gate – to remove the gate, turn out the screw in the lower side of the frame (hidden by the trigger guard), then the gate spring and catch can be withdrawn and the gate can be pushed out.

To reassemble your AWA revolver, follow the instructions above in reverse order. Wipe all metal parts with an oil cloth to remove finger prints which may cause corrosion.

! CAUTION – do not strip your revolver further than as described above. If additional maintenance is required, contact AWA directly. 877 -292-4867 or info@awaguns.com

! WARNING - do not attempt any alteration of the hammer or hammer safety or try to defeat the hammer safety in any way. Defeating the hammer safety of this or any firearm is Negligent behavior and voids any warranty of your product. Should you feel that your revolver is out of order, please contact AWA.

Storage

Store your revolver and explosive components securely locked in a separate location, out of reach and sight of children. (Children are naturally curious and do not believe the real danger of firearms.)

! CAUTION – always unload your revolver before storage and store explosive components (Ammunition) separately.

Do not store your revolver in an air tight container. Do not seal or attempt to seal the barrel or chambers to exclude dust, as the internal steel surfaces are more likely to corrode. Store explosive components (Ammunition) in accordance with the manufacturer's recommendations.

SERVICE

! CAUTION – if you make unauthorized adjustments or use unauthorized replacement parts, or in any way modify this firearm, AWA will not assume any responsibility for the correct functioning of this revolver.

Should your revolver require adjustment or repair, make sure it is not loaded and take it the dealer who sold it or send it directly to the factory.

! IMPORTANT – no unauthorized returns will be accepted. Call 877-292-4867 X 103 for a return authorization. Mark the outside of the box with the RA#.

Various federal and state laws and local ordinances govern the transfer and transportation of guns. Contact your local dealer for advice on how to transport your firearm to AWA for service.

Before shipping your revolver to AWA for service, remember the following:

- 1.) Make sure the revolver is unloaded!
- 2.) Write a letter explaining the problem and your requirements in as much detail as possible. Include the model and serial number.
- 3.) Include your return address and any phone numbers where you can be reached during AWA's business hours. Don't forget your email address.
- 4.) Do not send presentation boxes, accessories or explosive components. Insure the package and contents against loss or theft.

This instruction manual should always accompany this revolver and should be transferred with it upon change of ownership.

If you require a replacement instruction manual, contact:

AWA International, Inc.

1450 SW 10th St. 3B

Delray Beach, Florida 33444 1-877-292-4867 X 100

Have the revolvers serial number and description ready. A replacement will be shipped free.

PARTS AND ACCESSORIES

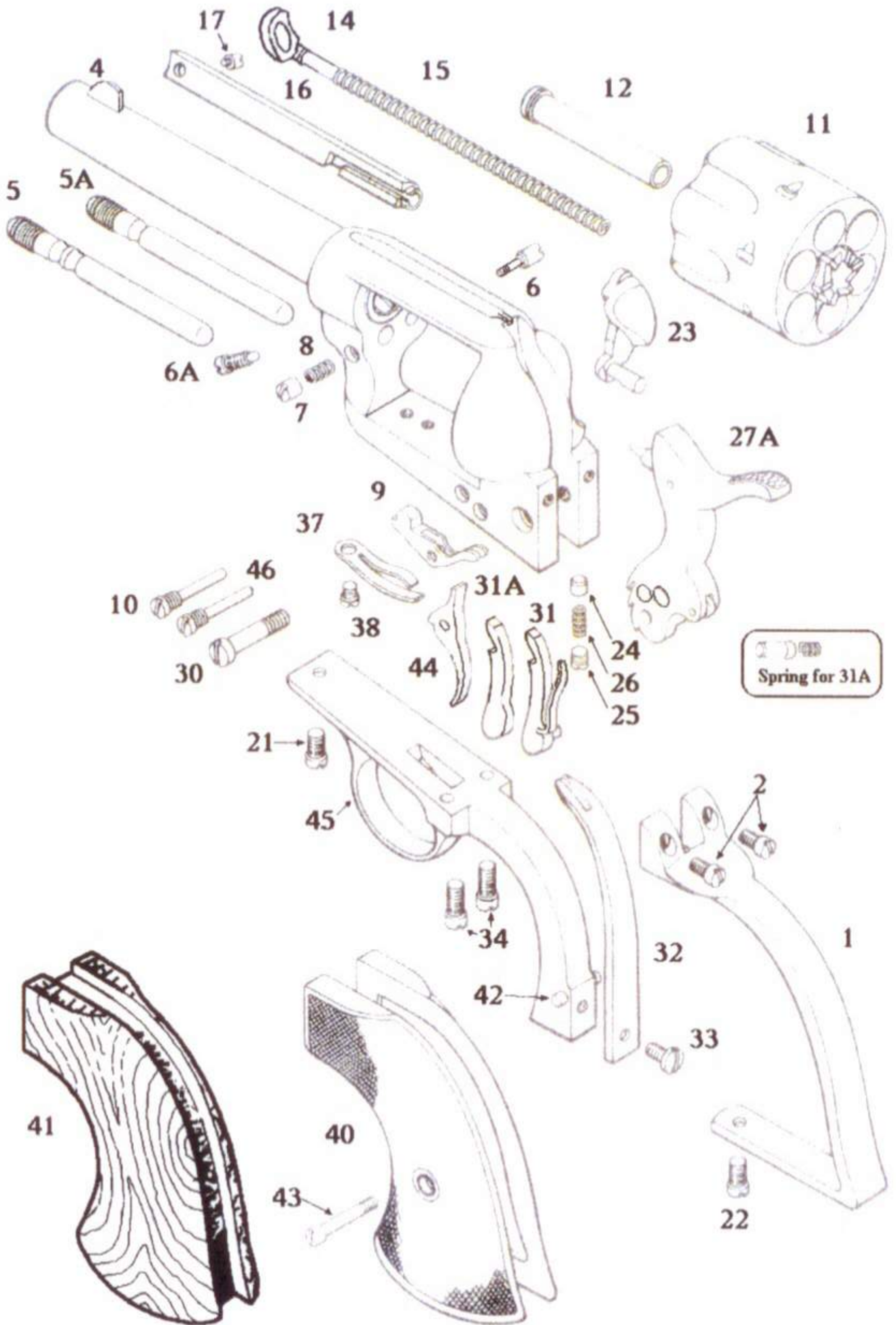

! WARNING
READ AND FOLLOW THE INSTRUCTION AND
WARNINGS IN THE MANUAL CAREFULLY BEFORE
USING THIS FIREARM.

Part #	Description	Retail
1	Back Strap	\$ 70.00
2	Back Strap Top Screw (2 needed)	\$ 3.00
4	Barrel	\$ 90.00
5	Base Pin	\$ 15.00
6	Base Pin Screw	\$ 7.00
7	Base Pin Nut	\$ 8.00
8	Base Pin Spring	\$ 3.50
9	Bolt	\$ 19.00
10	Bolt Screw	\$ 3.50
11	Cylinder with Bushing	\$ 90.00
12	Cylinder Bushing	\$ 20.00
13	Ejector Head (sold with #14)	\$ 28.00
15	Ejector Spring	\$ 3.50
16	Ejector Tube	\$ 50.00
17	Ejector Tube Screw	\$ 6.00
18	Firing Pin	\$ 7.00
19	Firing Pin Rivet	\$ 3.50
21	Front Trigger Guard Screw	\$ 3.00
22	Front Back Strap Screw	\$ 3.00
24	Gate Catch Detent	\$ 4.00
25	Gate Catch Screw	\$ 3.50
26	Gate Spring	\$ 3.50
27A	Hammer Assembly Deluxe	\$100.00
28	Hammer Roll	\$ 2.00
29	Hammer Roll Pin	\$ 4.00
30	Hammer Screw	\$ 7.00
31	Hand Assembly	\$ 20.00
32	Main Spring	\$ 16.00
33	Main Spring Screw	\$ 3.50
34	Rear Trigger Guard Screw (2 needed)	\$ 3.00
36	Recoil Plate (gunsmithing required)	\$ 20.00
37	Sear & Bolt Spring (Flat)	\$ 3.50
38	Sear & Bolt Spring Screw	\$ 3.50
39	Sear & Bolt Spring (Heine)	\$ 3.50
40	Stock (Grip) Plastic 2 piece (specify color)	\$ 25.00
41	Stock (Grip) Wood 1 piece	\$ 25.00
42	Stock (Grip) Pin	\$ 3.00
43	Stock (Grip) Screw Assembly	\$ 8.00
44	Trigger	\$ 19.00
45	Trigger Guard	\$ 80.00
46	Trigger Screw	\$ 3.50

Prices Subject To Change Without Notice

NOTES:

NOTES:

NOTES:

AMERICAN WESTERN ARMS

MODEL: _____

SERIAL #: _____

CALIBER: _____

BARREL LENGTH: _____

PURCHASE FROM: _____

NAME: _____

PURCHASE DATE: _____

AMERICAN
WESTERN
ARMS



TEXAS

Part Number AWA1B2002-1
Printed in the U.S.A. 8/02-1M



AWA International, Inc.
American Western Arms Division
1450 S.W. 10th Street, Suite 3B
Delray Beach, Florida 33444

Toll Free 1-877-AWA-GUNS
(292 - 4867)

Fax Line 561- 330 - 0881