

Owner's Manual

Instruction Book for:
MODEL 504™
RIMFIRE BOLT ACTION RIFLES

Remington®

IMPORTANT!

READ ALL INSTRUCTIONS
AND WARNINGS IN THIS
BOOK BEFORE USING THE FIREARM



PAGE 2THE TEN COMMANDMENTS OFFIRE ARM SAFETY
PAGE 7IMPORTANT PARTS OF THE FIREARM
PAGE 10HOW TO LOAD AND UNLOAD
PAGE 11LUBRICATION AND MAINTENANCE
PAGE 18HOW TO OBTAIN PARTS AND SERVICE

A Tradition of Performance and Safety.

In 1816 Eliphalet Remington was confident he could make a flintlock that was as good or better than any he could buy. His confidence was well founded. The barrel he handcrafted set a new standard for firearm accuracy and spawned generations of products that have made Remington® Arms America's leading gunmaker. While performance and style are certainly hallmarks of Remington firearms, one factor ultimately drives their performance. Safety. Eliphalet Remington never lost sight of the fact that his rifles were potentially lethal and could kill someone if handled improperly. And after more than 180 years the same holds true for any firearm, including your new Remington. Eliphalet Remington's first flintlock launched a proud tradition of accuracy and responsibility.



Eliphalet Remington's first flintlock launched a proud tradition of accuracy & responsibility

Safety is Critical to Performance.

A superbly crafted gun is only as good as the hands that hold it. You can never be too careful. Shooting accidents are often caused by careless oversights such as failing to control the direction of the muzzle, failing to fully engage the safety, leaving ammunition in the chamber or using improper loads. These oversights can result in the destruction of life, limb or property. There's no calling back a bullet once it's been fired, so it's critical that you know the principles of safe gun handling and storage before you ever take your new Remington firearm out of the box.

The proper use and performance of your firearm depends on correct assembly and maintenance, so it's critical that you familiarize yourself with the information in this instruction book. Even if you're a veteran shooter with a collection of Remington firearms, take the time to read this literature. Not all firearms are the same. That means the first step in safe handling is to learn the features and requirements of your new Remington.

THE TEN COMMANDMENTS OF FIREARM SAFETY

The Ten Commandments of Firearm Safety should be etched in your memory forever. Let them govern your action wherever and whenever you're involved with firearms. In the field. On the range. Or in your home. Please take the time to review and understand these rules.



1st COMMANDMENT

ALWAYS KEEP THE MUZZLE POINTED IN A SAFE DIRECTION.

This is the most important gun safety rule. A safe direction is one in which an accidental discharge will not cause injury to yourself or others. Never allow your gun to point at anything you don't intend to shoot. Be especially careful when you're loading or unloading. Treat every gun as if it were loaded. And make it a habit to know where the muzzle is pointed at all times, even when your firearm is un-loaded. No one will be injured by an accidental discharge if you keep your firearm pointed in a safe direction. It's as simple as that.



2nd COMMANDMENT

Firearms should be Unloaded When Not Actually in Use.

Load your firearm only when you're in the field or on the target range and ready to fire. Never let a loaded gun out of your sight or out of your hands. Unload it as soon as you're finished shooting - before you bring it into your car, camp or home. Remember, unloading your firearm means unloading it completely, so there is no ammunition in the chamber or in the magazine. Before handling a firearm or passing it to someone else, visually check the chamber, receiver and magazine to be certain they do not contain ammunition. Always keep the gun's action open when not in use. Never assume a gun is unloaded even if you were the last person to use it. Always check for yourself.

- *Let common sense rule* when you carry a loaded gun. If you're in a situation that could risk accidental discharge - such as crossing a fence, wading through a stream or climbing a tree - always unload your gun. Never pull or push a loaded firearm toward yourself or another person. And never carry a loaded gun in a scabbard, detached holster or gun case.

- *Certain firearms* (including some Remington® rifles and shotguns) are equipped with internal security devices to prevent unauthorized use. In addition, some firearms owners use external devices, such as cable locks and trigger blocks, for the same purpose. Even if you use such a device, you should still keep your firearm unloaded when stored or not in use. And using internal or external devices cannot substitute, however, for securing your firearms and ammunition in a separate, locked location.

- *Safe storage* of firearms is just as critical as safe handling. Never store guns loaded. Be sure to keep your firearms in a secure place where unauthorized persons cannot get their hands on them without your knowledge.

- *Take special care* if there are children around. Children are fascinated by guns. It's a natural curiosity that can have tragic consequences when not properly supervised. Store your firearms in a locked gun safe or some other location that physically bars a child from gaining access.

- *Ammunition* should be stored and locked in a location separate from your firearm. Never leave an unsecured firearm or ammunition in a closet, dresser drawer or under the bed. Remember, it is your responsibility to make sure that children and others unfamiliar with firearms cannot get access to your firearm and ammunition.



Firearms should be stored in a secure place where children cannot access them. A gun safe is an ideal way to secure your firearm

3rd C O M M A N D M E N T

DON'T RELY ON YOUR GUN'S SAFETY

Treat every gun as if it can fire at any time, whether or not there's pressure on the trigger. Your firearm has been carefully designed to maximize performance and safety. However, because a gun's safety is a mechanical device, it could fail.

Human error is a more likely reason for a gun safety to fail. By mistake, you may think the safety is on when it really isn't. Or the safety may have been disengaged without your knowledge. Or you could think your gun is unloaded when there's actually a cartridge or shell in it. A mechanical safety is not a substitute for common sense. It's merely a supplement to your proper handling of a firearm.

Never touch the trigger on a firearm until you are ready to shoot. Keep your fingers away from the trigger when you're loading or unloading. And don't pull the trigger when the safety is engaged or positioned between safe and fire.

Before using your gun, read this instruction book to understand the exact location and operation of your firearm's safety. Even when the safety is on, maintain control of your loaded firearm and control the direction of the muzzle. In other words, don't rely on your safety to justify careless handling. If your firearm's internal mechanisms are broken or have been altered, your firearm may fire even when the safety is on. Remember, you and your safe gun handling practices are your gun's best safety.

4th C O M M A N D M E N T

BE SURE OF YOUR TARGET AND WHAT'S BEYOND IT.

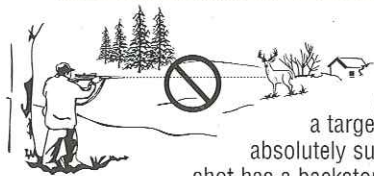

You can't stop a shot in mid-air, so never fire unless you know exactly where your shot is going and what it will strike. Never fire at a sound, a movement or a patch of color. A hunter in camouflage can easily be mistaken for a target by an impulsive shooter. Before you pull the trigger be absolutely sure of your target and what's behind it. Make sure the shot has a backstop such as a hillside or dense material like sand.

Remember, bullets can travel great distances with tremendous velocity. Know how far your shot will go if you miss your target or the bullet ricochets.



5th COMMANDMENT

Use Proper Ammunition

Every firearm is designed to use a certain caliber or gauge of ammunition. Using the wrong ammunition, mixing ammunition or using improperly reloaded ammunition can cause serious personal injury or death. And it only takes one cartridge or shotshell of the incorrect caliber or gauge, or which has been improperly reloaded, to destroy your firearm. It's your responsibility to make sure the ammunition you use exactly matches the caliber or gauge of your gun. Refer to this instruction book to find out the specific requirements of your firearm. Always read and heed the instructions on ammunition boxes.

Confusing shells or cartridges can cause serious personal injury or death and destroy your firearm. Examine your shells or cartridges closely and use only the precise caliber or gauge for your specific firearm. For example, suppose you accidentally loaded a 20 ga. shell into a 12 ga. shotgun. Because the 20 ga. shell is too small for the chamber, the 20 ga. shell could travel down the barrel and get lodged in the bore. If you then loaded a standard 12 ga. shell behind it and fired, the 12 ga. shot will slam into the lodged 20 ga. shell and may cause the barrel to explode right in your hand. This is commonly called a 12/20 burst, and it can kill you.

Check all ammunition before you load it to make sure it matches your gun's requirements. Every Remington® cartridge and shell is head-stamped with its caliber or gauge for easy identification. Likewise, you'll find the caliber or gauge of your new Remington firearm imprinted on the barrel.

Reloading Requires Extra Diligence.

If you're an ammunition reloader, you are responsible for personally assuring that the loads and components of your reloaded ammunition meet your gun's factory-tested standards. Never use ammunition, which has been reloaded by someone else!

Many shooters handload as a hobby or to save money on commercial, factory-made ammunition. However, it requires a thorough knowledge of reloading procedures and a deep respect for the explosive potential of gunpowder.

Firearms are designed, manufactured and proof-tested to standards based on factory-loaded ammunition. Handloaded or reloaded ammunition that deviates, either intentionally or accidentally, from load or component recommendations can be very dangerous.

Reloaders must observe all possible safety precautions and practices related to the proper handling of explosives. Whether you're a seasoned reloader or just starting out, you should study the subject, watch reloading demonstrations and talk to experienced reloaders.

The first rule of reloading is to always follow the manufacturer's instructions for the components you're using. They'll tell you to follow certain guidelines. Namely:

1. Don't mix or substitute powders or primers.
2. Don't use unknown or substandard components.
3. Use only suitable components that have been factory-tested by reputable ammunition, powder and bullet manufacturers.
4. Always be sure to use the manufacturer's recommended recipe when reloading.

Not following these guidelines could result in severe injury to yourself or severe damage to your firearm. Dangerously high pressure and explosions can result from an overcharge of powder or other deviations from established reloading guidelines. Be very careful. The process of reloading exposes you to environmentally hazardous material. Lead, which is known to cause cancer and birth defects, is the most common substance in bullets and shot. It is important to handle lead bullets and shot with extreme care. Work only in a well-ventilated area and always wash your hands after exposure and before eating. Never smoke while reloading.

Primers and powders are also highly toxic and flammable. So after reloading be sure to clean up all materials from your work area. Don't leave primer or powder spills anywhere on the floor or bench top. Dispose of all waste material in accordance with the manufacturer's recommendations.

Finally, when reloading or handloading concentrate on what you're doing at all times. Do not be distracted by talking to others, listening to the radio or watching TV while reloading. Never reload after consuming alcoholic beverages or drugs of any kind. You are working with extremely hazardous materials and you can't risk even a few seconds of distraction. Remember, if you reload, you are the ammunition manufacturer and you are responsible for the performance and safety of your reloaded ammunition.

6th COMMANDMENT

IF YOUR GUN FAILS TO FIRE WHEN THE TRIGGER IS PULLED, HANDLE WITH CARE.

If for some reason the ammunition doesn't fire when you pull the trigger, stop and remember the 1st Commandment of Firearm Safety - always keep the muzzle pointed in a safe direction. Keep your face away from the breech, then put the safety on, carefully open the action, unload the firearm and dispose of the cartridge safely. Remember that anytime there's a shell in the chamber, your gun is loaded and ready to use. Even if you tried to shoot and your gun didn't fire, treat your firearm as if it could still discharge.

7th COMMANDMENT

ALWAYS WEAR EYE AND EAR PROTECTION WHEN SHOOTING.

Your sight and hearing risk injury from shooting and should be protected at all times. Wear protective shooting glasses to guard against falling shot, clay target chips, powder residue, ruptured cartridge cases and even twigs and branches in the field. Also be sure to wear eye protection when you're disassembling or cleaning a gun so that tensioned parts (like springs) and cleaning solvents don't come in contact with your eyes. Continued exposure to shooting noise can permanently damage your hearing. On the range, where shooting volume is the loudest, be sure to use the maximum protection of a headset. And learn to use ear protection in the field, especially in confined locations like duck blinds.



8th COMMANDMENT

BE SURE THE BARREL IS CLEAR OF OBSTRUCTIONS BEFORE SHOOTING.

Before loading your gun, open the action and make sure there's no ammunition in the chamber or magazine. Check the barrel for any obstructions or debris. Even a small amount of snow, mud, excess lubricant or grease in the bore can dangerously increase pressure and cause the barrel to bulge or burst when firing. Use a cleaning rod and patch to wipe away anti-rust compounds or any other residues or obstructions in the barrel. Never try to shoot out an obstruction by loading another shell and firing!

When firing, rely on your instincts. If the noise or recoil of your firearm seems weak, stop everything, unload your firearm and be sure nothing is lodged in the barrel. Remember the 12/20 burst? That's what can happen when the barrel is obstructed. So always be sure you're using the correct ammunition in your firearm and that it's free of obstructions.

9th COMMANDMENT

DON'T ALTER OR MODIFY YOUR GUN AND HAVE IT SERVICED REGULARLY.

Your firearm has been designed to operate according to certain factory specifications. You'll jeopardize your safety and that of others around you by attempting to alter its trigger, mechanical safety or other mechanisms. So never alter or modify your firearm in any way.



Like any mechanical device, a firearm is subject to wear. It must be maintained and periodically serviced to assure optimum safety and performance. Only a qualified service facility should service, repair or modify your Remington® firearm. Consult your instruction book for instructions on how to send your firearm to the factory or for the location of the nearest Remington repair station.

Proper cleaning and lubrication are also important to firearm maintenance and are necessary to assure accuracy, safety and reliability. Before cleaning, always make sure that your gun is completely unloaded. And always clean the barrel from the chamber end to the muzzle when possible.

Make it a practice to clean your bore every time you're going to shoot. Be sure to clean your entire gun before and after long-term storage and no less than once a year. It's also important to clean your gun whenever it's been exposed to adverse conditions such as rain, dirt, mud, snow, sleet or saltwater.

For safe and dependable operation of your firearm, all parts of your gun must be properly cleaned and lubricated. Periodically inspect the internal workings of your firearm to be sure they're clean and free of rust, unwanted dirt and debris.

Use recommended lubricants on your gun and do not over-lubricate. Excessive use of a non-recommended lubricant could adversely affect the function and safe operation of your firearm. Remember, you are responsible for the proper care and maintenance of your firearm. Failure to properly maintain your firearm cannot only damage or ruin your firearm, it can expose you and others to unnecessary risks of personal injury or death.

Remington® has a wide range of firearm care products and resources for best results when cleaning your gun. Everything from solvents and lubricants to rods and patches. They're all available from your Remington dealer.



10th C O M M A N D M E N T

LEARN THE MECHANICS AND HANDLING CHARACTERISTICS OF YOUR FIREARM.

Not all guns are alike. They have different mechanical characteristics that dictate how you should carry and handle them. Anyone who plans to use a firearm should first become totally familiar with the type of firearm it is and the safe handling procedures for loading, unloading, carrying, shooting and storing it.

Before you even unpack your new Remington firearm, read this instruction book from cover to cover and familiarize yourself with the different component parts of the gun. Then read, understand and follow the Ten Commandments of Firearm Safety in this book.

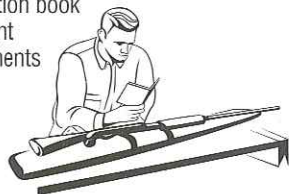

WARNING! Discharging firearms in poorly ventilated areas, cleaning firearms or handling ammunition may result in exposure to lead, a substance known to cause birth defects, reproductive harm, cancer and other serious physical injury. Have adequate ventilation at all times. Wash hands thoroughly after exposure.

SHOOT SOBER!!

There's one other rule that must be followed when handling firearms. In fact, respect for this rule is necessary in order to effectively practice the Ten Commandments of Firearm Safety. The rule is: SHOOT SOBER! Guns and alcohol or drugs make a deadly combination. Never consume anything that would mildly impair your judgment or physical coordination when you're using a firearm. A staggering percentage of the shooting accidents that occur every year involve alcohol or drugs. Be smart. Always shoot sober and stay alive.

WARNING! Failure to follow any of these safety rules may cause personal injury or death to the shooter or bystander and damage to property. Do not use a firearm until you fully understand and practice the Ten Commandments of Firearm Safety. If you have any questions about the safe use of a Remington firearm, write to us at Remington Arms Company, Inc., Consumer Service, P.O. Box 700, Madison, NC 27025-0700, or call us at 1-800-243-9700.

DON'T KEEP THIS TO YOURSELF.

Now that you're a gun owner you have the obligation to help ensure that shooting sports are safe for everyone - participants and bystanders alike. You can do that by practicing these principles of firearm safety and passing them on to others - especially new shooters. Set an example for beginners. Be a guide to their safe entry into the exciting world of shooting sports. Invest your time and patience for the love of the sport and for its future. After all, it's your love of the sport that led you to buy a new Remington.

Firearm ownership is a right and privilege. It's a right guaranteed in this nation's Constitution. It's a privilege, which carries with it a personal responsibility to use your firearm in a way which will ensure your safety and the safety of others. The preservation of this right and privilege depends on the personal commitment of you and your fellow shooters to the safe and responsible use of firearms. Let the Ten Commandments of Firearm Safety outlined in the book guide you at all times. Teach and promote these rules whenever you can. Remember, firearm safety depends on you! That's the only way to really enjoy your new Remington firearm and to preserve sport shooting as we know it today.

Remington® Bolt Action Rimfire Rifle

Congratulations on your choice of a Remington.® With proper care, it should give you many years of dependable use and enjoyment. For best results, we recommend that you use Remington Ammunition - the ammunition used in factory testing your firearm against our rigorous function and performance standards.

PICTURE 1 This picture shows the main parts of a REMINGTON® MODEL 504 BOLT ACTION RIFLE. The picture will aid in understanding the instructions.

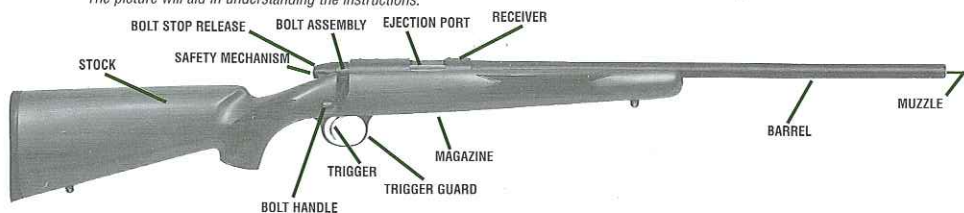

Important Parts of the Firearm

Firearm Serial Number

The firearm's serial number is located on the shooter's left side of the receiver.

The Safety Mechanism

The safety mechanism of the Model 504™ rifle provides protection against accidental or unintentional discharge under normal usage when properly engaged and in good working order. The safety mechanism is not a substitute for following the rules of safe gun handling.

To engage the safety mechanism, pull the safety arm fully to the rear towards the "S" position. See Picture 2.

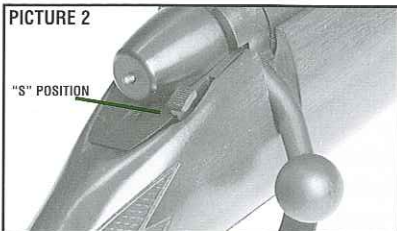

Always put the safety in the "S" position before handling, loading or unloading the firearm.

When you are ready to FIRE the firearm, push the safety arm forward to the "FIRE" position which is marked with a "F". You have now disengaged the safety and the rifle is in the ready to fire position. See Picture 3.

Do not touch the trigger while moving the safety arm. Your fingers and all other objects should be kept outside of the trigger guard and away from the trigger until you are actually ready to fire.

Never pull the trigger when the safety is in the "S" or "SAFE" position.

PICTURE 3

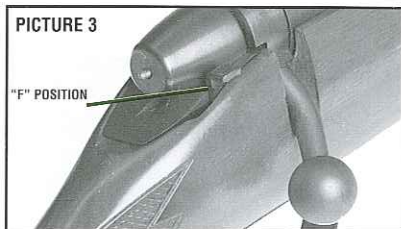

WARNING! The firearm will FIRE when the trigger is pulled and the safety mechanism is in the "F" or "FIRE" position.

Even when the safety is engaged in the "S" OR "SAFE" position, careless handling can cause the firearm to fire. SEE THE TEN COMMANDMENTS OF FIREARM SAFETY ON PAGE 2.

The Locking Device

This firearm was originally sold with a key-operated locking device to assist the owner in protecting against unauthorized use. These are storage, locking devices and the firearm should be unloaded when stored or not in use. Using a locking device cannot substitute securing your firearm and ammunition in a separate, locked location. See the 2nd Commandment of firearm safety.

THE LOCKING DEVICE PROVIDED DOES NOT ELIMINATE THE NEED FOR SAFE GUN HANDLING AND STORAGE, INCLUDING KEEPING THIS AND EVERY GUN UNLOADED AND LOCKED IN A SECURE PLACE WHEN NOT IN USE. READ AND FOLLOW THESE AND OTHER SAFETY RULES IN THIS INSTRUCTION BOOK. FAILURE TO READ, UNDERSTAND AND OBEY THESE RULES CAN RESULT IN SERIOUS PERSONAL INJURY OR DEATH. SEE THE TEN COMMANDMENTS OF FIREARM SAFETY ON PAGE 2.

Keep your locking device engaged when your firearm is not in use. Keep the keys in a secure place, inaccessible to others. DO NOT leave your keys or any ammunition with your firearm, which should be kept unloaded and locked in a safe place.

To Install the Bolt Assembly:

The bolt assembly locks the cartridge into the chamber.

1. Point the firearm in a safe direction.
2. Engage the safety mechanism by placing the safety arm in the "S" or "SAFE" position.
3. Before inserting the bolt, make sure the firing pin is cocked. When the firing pin is cocked, an indicator is visible at the rear of the bolt. See Picture 4.

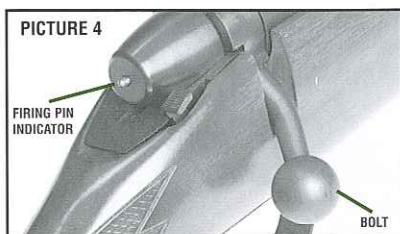

4. If the firing pin is not in the cocked position, refer to instructions "To Reassemble the Bolt Assembly" on page 15.

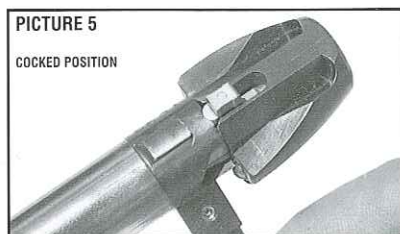

5. Place the bolt handle in the upward position.
6. Point the head of the bolt toward the front of the rifle. Ensure the receiver bolt stop is aligned with the slot located on the side of bolt. See Picture 6.

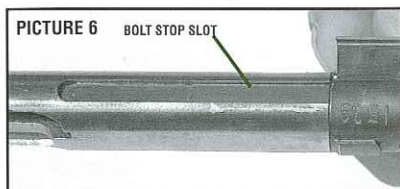

7. Slide the bolt assembly forward into the receiver until it stops.

8. To place the bolt assembly in closed position, push the bolt handle down.

To Remove the Bolt Assembly:

1. Point the firearm in a safe direction.
2. Engage the safety mechanism by placing the safety arm in the "S" or "SAFE" position.
3. Lift the bolt handle, and pull the bolt back until it stops.
4. Depress and hold the bolt stop release, located on the side of the receiver. See Picture 7.
5. Pull the bolt rearward, sliding the bolt assembly from the firearm.

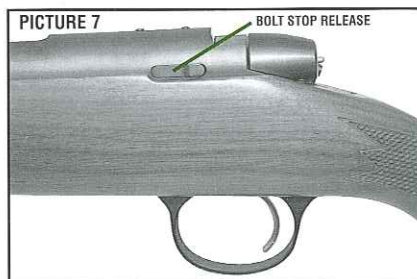

To Remove An Empty Magazine:

1. Point the firearm in a safe direction.
2. Engage the safety mechanism by placing the safety arm in the "S" or "SAFE" position.
3. Lift the bolt handle and pull the bolt back all the way until it stops.
4. Visually check the chamber to make sure it is empty.
5. Pull the magazine latch rearward and hold, releasing the magazine box. See Picture 8.
6. Remove the magazine from the firearm by pulling downward.

To Remove a Loaded Magazine:

WARNING! If you pick up the firearm and the action is closed, there may be a live round in the chamber.

1. Point the firearm in a safe direction.
2. Engage the safety mechanism by placing the safety arm in the "S" or "SAFE" position.
3. Lift the bolt handle and pull the bolt back all the way until it stops.
4. Visually check the chamber to make sure it is empty.
5. Pull the magazine latch rearward and hold, releasing the magazine box. See Picture 8.
6. Remove the magazine from the firearm by pulling downward.

WARNING! Removing the magazine from the rifle does not prevent the rifle from being

fired. If a cartridge is in the chamber and the safety mechanism is in the "F" or "FIRE" position, the cartridge in the chamber can be fired by pulling the trigger. This is true even if the magazine is not in the rifle. **THE RIFLE WILL FIRE WITH THE MAGAZINE REMOVED!**

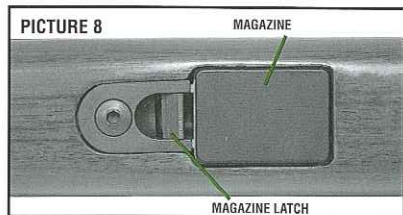

The Trigger Assembly

Pulling the trigger fires the firearm.

The trigger assembly of the Model 504 rifle has been set at the Remington factory for optimal trigger pull weight, sear engagement, and overtravel. The factory settings provide a crisp, clean trigger pull for superior out-of-the-box accuracy for hunters, plinkers, and target shooters. Certain experienced and responsible target shooters competing in controlled shooting environments may, however, wish to have their firearm's factory settings adjusted to suit their individual shooting preferences. For use by competitive target shooters only, the Model 504 trigger assembly is adjustable within certain limits.

Trigger Adjustment/Alteration Warnings

WARNING! Changes from factory trigger settings can create a hazardous condition in the rifle causing an accidental discharge resulting in **SERIOUS PERSONAL INJURY OR DEATH.**

Trigger adjustments may be made **ONLY** in the following circumstances:

I. For competitive target shooters **ONLY**:

(1) The trigger assembly of the Model 504 rifle should be adjusted **ONLY** for use by experienced and responsible shooters in a controlled target shooting environment where the rifle is **NEVER** loaded with a live round of ammunition except when it is in the ready-to-fire position with the muzzle pointed safely down range. (2) If a cartridge is loaded into the chamber and then not fired, it should be **IMMEDIATELY** unloaded from the rifle. **NEVER** move the rifle away from the down-range position without first unloading the

round from the chamber. (3) **WARNING! NEVER carry an adjusted rifle with a live round in the chamber.** Trigger assemblies on rifles used for hunting or for noncompetitive target shooting must **NEVER** be adjusted.

II. Adjustments may be made **ONLY** by a Remington® Authorized Repair Center:

Trigger assembly adjustments may be made **ONLY** by a Remington® Authorized Repair Center. **NEVER** make any trigger adjustments yourself. To locate the Remington® Authorized Repair Center nearest you, see the product literature packaged with the rifle or visit the Remington® website at www.Remington.com.

WARNING! Firearm sale or transfer:

If your rifle's trigger assembly has been adjusted and you intend to sell or otherwise transfer possession of your rifle, you **MUST**: (1) warn the purchaser or recipient of your rifle that its trigger assembly has been adjusted, and (2) give the purchaser or recipient this owner's manual for review and reference. If you do not wish to sell or transfer your rifle in an adjusted condition, return it to a Remington® Authorized Repair Center for restoration of your rifle's trigger assembly to its original factory settings. **DO NOT** attempt to restore the rifle to factory settings yourself.

WARNING! NEVER alter or modify any part of the trigger assembly or any part of the firing mechanism. Improper alterations can make the rifle unsafe and result in personal injury or death.

WARNING! NEVER put your finger on the trigger unless you are going to fire the firearm.

The Barrel

WARNING! The inside of the barrel must be clean and free of obstructions. See the *Ten Commandments of Firearm Safety*.

To check the inside of the Barrel:

1. Point the firearm in a safe direction.
2. Engage the safety mechanism by placing the safety arm in the "S" or "SAFE" position.
3. Remove the magazine from the firearm. See Instructions on page 8.
4. Lift the bolt handle and pull the bolt back until it stops.
5. Depress and hold the bolt stop release, located on the side of the receiver. See Picture 7.
6. Pull the bolt rearward, sliding the bolt assembly from the firearm.
7. Remove any ammunition from the cham-

ber. See page 11, "To Unload Firearm."

8. Look through the inside of the barrel from the chamber end to the muzzle.
9. Insert a cleaning rod from the chamber end. Push the rod completely through the barrel until the rod can be seen at the muzzle.

To remove object from inside the Barrel:

WARNING! NEVER try to remove an object from the barrel by loading another cartridge and firing. This may cause the barrel to burst or a cartridge case to rupture and cause serious personal injury or death.

1. Point the firearm in a safe direction.
2. Engage the safety mechanism by placing the safety arm in the "S" or "SAFE" position.
3. Remove the magazine from the firearm. See Instructions on page 8.
4. Lift the bolt handle and pull the bolt back until it stops.
5. Depress and hold the bolt stop release, located on the side of the receiver. See Picture 7.
6. Pull the bolt rearward, sliding the bolt assembly from the firearm.
7. Visually check the chamber to make sure the rifle is completely unloaded.
8. Insert the correct size-cleaning rod into the chamber and lightly tap rod to free object from the barrel.
9. Push the rod all the way through the barrel until the rod can be seen in the muzzle.
10. If an object cannot be easily pushed out of the barrel with a cleaning rod, return the firearm to the factory or a REMINGTON® AUTHORIZED REPAIR CENTER.

To clean the barrel follow the instructions shown on Page 12 before loading the firearm.

NOTE: Make sure the inside of the barrel is free of dirt or other obstructions.

To Load the Firearm:

WARNING! Model 504™ bolt action rimfire rifles are manufactured in a variety of popular rimfire calibers. The specific caliber of rimfire ammunition suitable for use in your rifle is marked on the barrel of your rifle. Only use the specific caliber of rimfire ammunition which is designated on the barrel or your rifle. Different calibers of rimfire ammunition are

not interchangeable. Do not use any ammunition other than the designated rimfire caliber specified for your rifle. USING INCORRECT AMMUNITION IN YOUR FIREARM, CAN CAUSE A JAM OR SEVERE MALFUNCTION OF YOUR FIREARM OR AMMUNITION LEADING TO PERSONAL INJURY OR DEATH. See the Ten Commandments of Firearm Safety on pages 2-6 of this manual.

To load the chamber and the magazine:

NOTE: The barrel should be cleaned before loading and firing the firearm the first time. Follow cleaning instructions shown on page 11.

1. Point the firearm in a safe direction.
2. Engage the safety mechanism by placing the safety arm in the "S" or "SAFE" position.
3. Lift the bolt handle and pull the bolt back all the way until it stops.
4. Visually check the chamber to make sure it is empty.
5. Pull the magazine latch rearward and hold, releasing the magazine box. See Picture 8.
6. Remove the magazine from the firearm by pulling downward.

WARNING! Always check the cartridge for the correct caliber before loading the firearm. Do not attempt to exceed the cartridge capacity of the magazine box.

7. Load cartridges one at a time into the magazine. Keep the bullets aligned toward the chamber. See Picture 9.
8. Put the loaded magazine into the firearm.



PICTURE 9

9. Make sure the magazine is fully latched into position.
10. Slowly slide the bolt assembly forward feeding the first cartridge into the chamber.
11. Push the bolt handle down in the locked position.

WARNING! The rifle is now cocked and loaded. Make sure the safety mechanism is still engaged, or in the "S" or "Safe" position. Keep the rifle pointed in a safe direction.

Both the chamber and the magazine are now loaded.

NOTE: Read the following important information about loading the magazine.

Loading The Magazine

Due to variations in rimfire ammunition, care should be taken when loading the magazine not to overlap the rims of the cartridges. If rims overlap, a failure to feed a round from the magazine may occur. The loaded round should be inserted into the magazine by putting pressure near the rim. See Picture 10. Do not insert by pushing near the nose of the bullet.

If the magazine becomes hard to load to full capacity, unload magazine, disassemble and clean the magazine components. Do not use solvents that are harmful to plastic materials. For cleaning instructions see page 14.

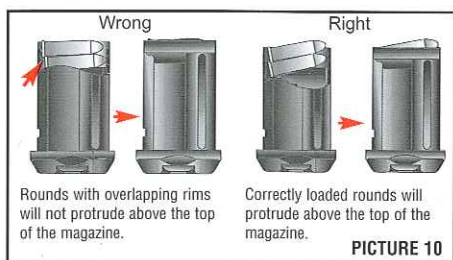

To Unload The Firearm:

WARNING! NEVER assume your rifle is unloaded to justify careless handling. Always control the direction of the muzzle of your rifle, even if you think it is completely unloaded. See The Ten Commandments

1. Point the firearm in a safe direction.
2. Engage the safety mechanism by placing the safety arm in the "S" or "SAFE" position.
3. Lift the bolt handle and slowly pull the Bolt Assembly back to remove the cartridge remaining in the chamber. Visually check the chamber to make sure there are no other obstructions.
4. Pull the magazine latch rearward and hold, releasing the magazine box.
5. Remove the magazine from the firearm by pulling downward.
6. While holding the magazine separate and apart from the firearm, slide the top cartridge forward and out of the magazine. Repeat until the magazine is completely empty. See Picture 11.

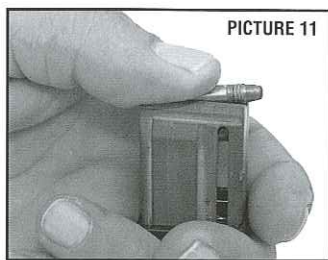

WARNING! Visually check the chamber and receiver to make sure the chamber and magazine are completely empty. Make sure the safety mechanism is still engaged or in the "S" or "SAFE" position.

Telescopic Sights:

The top of the Model 504™ receiver has mounting holes for the installation of telescopic sights.

WARNING! Before mounting or adjusting the telescopic sight, make sure the rifle is completely unloaded and engage the safety mechanism by placing the safety in the "SAFE" position.

NOTE: For more on ballistics and trajectory, see the REMINGTON® catalog or visit Remington® website at www.remington.com.

Cleaning, Lubrication and Maintenance

WARNING! Before cleaning, make sure your rifle is completely unloaded (both the chamber and the magazine) and engage the safety mechanism by placing the safety in the "S" or "SAFE" position.

WARNING! After each use, follow the lubrication and maintenance direction in this instruction book. If the firearm is immersed in water, it must be thoroughly cleaned and lubricated as soon as possible. In case of saltwater immersion, first flush all parts with fresh water, then dry, clean and lubricate the firearm. If the firearm does not function properly, have it checked and corrected by a competent gunsmith before further use. Failure to obey this warning may lead to firearm malfunctions which could result in serious personal injuries or death.

NOTE: The chamber and bore should be cleaned before loading and firing the firearm the first time.

Lubrication:

Over-lubrication should be avoided at all times. A light application of Rem™ Oil helps to prevent rusting. See note below.

WARNING! Excessive use of a non-recommended lubricant could adversely affect the function and safe operation of your rifle. Failure to properly maintain your rifle can not only damage your rifle, it can expose you and others to unnecessary risks of personal injury or death.

When the firearm is to be stored, it should be carefully cleaned and thoroughly oiled. Outside metal surfaces should be wiped with Rem™ Oil occasionally.

When the firearm is to be reused, all excess lubrication must be removed. The chamber and bore must be thoroughly swabbed clean and dry.

For safe and dependable operation of your rifle, the chamber and action must be cleaned periodically.



To Clean the Barrel:

WARNING! Visually check the chamber and magazine to make sure there are no cartridges in the firearm.

1. Point the rifle in a safe direction.
2. Engage the safety mechanism by placing the safety arm in the "S" or "SAFE" position.
3. Lift the bolt handle and pull the bolt back until it stops.
4. Depress and hold the bolt stop release, located on the side of the receiver. See Picture 7.
5. Pull the bolt rearward, sliding the bolt assembly from the firearm.
6. Visually check the chamber to make sure it is empty.
7. Pull the magazine latch rearward and hold, releasing the magazine box. See Picture 8.
8. Remove the magazine from the firearm by pulling downward.
9. Use the instructions and equipment provided in a quality cleaning kit such as Remington® Cleaning Kit. For recommendations, see your dealer or a Remington® Authorized Gunsmith.
10. Saturate cleaning patch with Brite Bore™ or equivalent.
11. Attach the patch to cleaning rod tip.
12. Pass patch through bore from chamber end to muzzle several times to remove loose residue and fouling.

13. Select the correct caliber cleaning brush and attach the brush to the cleaning rod.
14. Spray bore brush with Brite Bore.
15. Push the cleaning rod through the barrel several times.
16. Remove the brush from the rod, attach tip with cleaning patch and push through the bore.
17. Repeat several times, using a new cleaning patch each time until the patch is clean.
18. Push a clean patch saturated with Rem™ Oil through the barrel.
19. Push a clean dry patch through the barrel to remove excess lubricant.
20. Apply a light application of Rem™ Oil to the outside of the barrel with a soft clean cloth.

WARNING! After cleaning, make sure the barrel is free of obstructions.

To Disassemble The Firearm For Cleaning:

CAUTION: The Model 504™ rimfire rifle should not be disassembled beyond what is described in this instruction book, except by the factory or a REMINGTON® Authorized Repair Center.

WARNING! Unload before cleaning. Visually check the chamber and magazine to make sure there are no cartridges in the firearm. Always wear eye protection when disassembling and reassembling the firearm.

1. Engage the safety mechanism by placing the safety arm in the "S" or "SAFE" position.
2. Remove the bolt assembly. See instructions on page 8.
3. Pull the magazine latch rearward and hold, releasing the magazine box from the firearm. See Picture 8.
4. Visually check the chamber and action again to make sure the rifle is completely unloaded.
5. Remove the front and middle takedown screws, using a 1/8" Allen Wrench. See Picture 12.

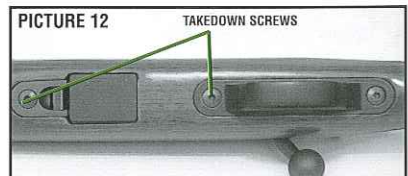

6. It is not necessary to remove the rear trigger guard screw.
7. Lift and remove the action from the stock.
8. For disassembling the bolt assembly See: "To Clean the Bolt assembly" on page 14.

To Clean the Receiver and Trigger Assembly:

NOTE: Clean and lubricate the receiver and trigger assembly as a unit.

Do not remove the trigger assembly from the receiver.

9. Thoroughly spray the receiver inside and out with Rem™ Action Cleaner and allow to dry.
10. Thoroughly spray inside the trigger assembly at the four points specified in Picture 13 with Rem™ Action Cleaner.

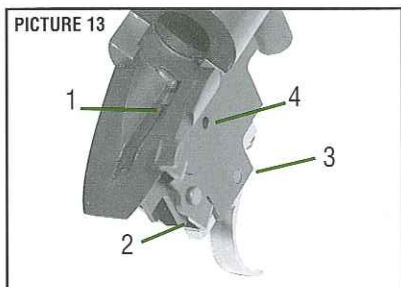

11. Place the safety in the "OFF" or "FIRE" position. Pull the trigger rearward and release multiple times.
12. Pull and hold the trigger rearward. While using a small punch or screwdriver, depress the sear (Lubrication Point 1, see Picture 14) and release multiple times.
13. Release the trigger and operate the safety from the "FIRE" to the "SAFE" position multiple times.
14. Again thoroughly spray inside the trigger assembly at the four points specified in Picture 13 with Rem™ Action Cleaner. Air dry or use compressed air to thoroughly dry the trigger assembly.
15. Spray Rem™ Oil in each of the four (4) points in the trigger assembly specified in Picture 13.
16. Disengage the safety by placing the safety arm in the "F" or "FIRE" position. Pull the trigger rearward and release multiple times. Ensure the trigger returns completely to the forward position each time. If the trigger does not completely return, reassemble the rifle and return it to a

Remington® Authorized Repair Center for service.

WARNING! If the trigger does not fully return to the forward position each time it is released, then your rifle is NOT in a Safe operating condition and it must NOT be used until you have had it repaired by a Remington® Authorized Repair Center.

17. If the trigger completely returns as specified in operation 16, pull and hold the trigger rearward while using a small punch or screwdriver to depress and release the sear multiple times. (Lubrication Point 1, see Picture 14). The sear must return to the full upward position without hesitation. If the sear does not freely return, reassemble the rifle and return it to a Remington® Authorized Repair Center for service.

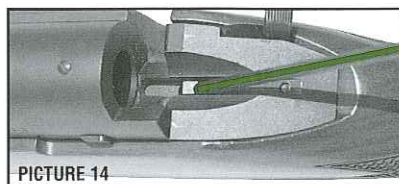

WARNING! If the sear does not return to the full upward position without hesitation, then your rifle is NOT in a safe operating condition and it must NOT be used until you have had it inspected by a Remington® Authorized Repair Center.

18. If the sear freely returns to the full upward position as specified in operation 17, release the trigger and operate the safety mechanism from the "FIRE" to the "SAFE" position multiple times. The safety mechanism must operate freely. The safety detent spring must position the safety in the "S" or "SAFE" position. The safety should NOT remain in a position anywhere between the "SAFE" and "FIRE" position. If the safety mechanism does not freely return to the full "SAFE" or "FIRE" position, repeat operations 10 thru 18. If the safety mechanism does not freely return to the "SAFE" or "FIRE" position after repeating operations 10 thru 18, return the firearm to a Remington® Authorized Repair Center for an inspection of the safety and trigger assembly.
19. Place the safety in the "S" or "SAFE" position and lightly spray Rem™ Oil on all the external surfaces of the trigger assembly and receiver. Wipe off excess oil.

20. Install bolt, see "To Install Bolt Assembly" on page 8.

WARNING! After cleaning the trigger assembly, check the chamber and magazine to make sure there are no cartridges in the firearm. Disengage the safety mechanism by moving the safety arm to the "F" or "FIRE" position. Close the bolt smartly. The firing pin must remain cocked. To check, pull the trigger. The firing pin must fall. Repeat the test at least ten times. If the firing pin will not remain cocked when the bolt is closed smartly, return the firearm to the factory or a Remington® Authorized Repair Center. (Firing the M/504 without a cartridge in the chamber (dry fire) will not harm the firearm.)

To Clean The Magazine Assembly:

WARNING! Visually check to make sure there are no cartridges in the magazine box.

For instructions on how to remove the magazine from the rifle, see instructions on page 8.

1. Compress the magazine spring through viewing window toward the top of the magazine box, using a small screwdriver or punch. See Picture 15.

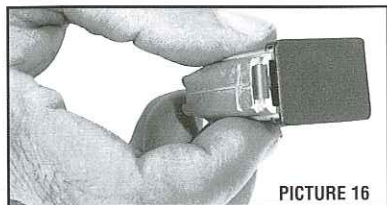
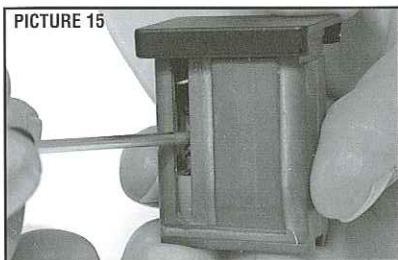

WARNING! Use extreme care when removing the magazine bottom, as the magazine spring is under compression. Wear eye protection to avoid serious personal injury.

2. Slide the magazine bottom out while compressing the magazine's spring toward the top of the magazine box. The spring will

3. Slowly release the magazine spring.
4. Remove the magazine spring retainer, spring, and follower.
5. Clean the magazine and follower with brush or cloth in warm water and household dish-washing detergent. Do not use lubricant in magazine.

To Reassemble the Magazine Assembly:

1. Place the follower into magazine. The follower should drop freely into place.
2. Insert the magazine spring into the magazine with the coils aligned as shown. See Picture 17.



3. Position the posts of the magazine spring retainer into the last coil of the magazine spring.
4. Depress the follower, magazine spring, and the spring retainer through the viewing window toward the top of the magazine box, using a small screwdriver or punch. See Picture 15.
5. Slide the magazine bottom onto the magazine box, until the bottom snaps into place.
6. Slowly release the magazine spring.

To Clean The Bolt Assembly:

1. Remove the bolt assembly from the firearm. See instructions on page 8.
2. Grasp bolt with a clean dry cloth, with one thumb placed on the bottom of the bolt and the other hand holding the bolt handle.
3. While gripping the bolt body firmly, uncock the bolt by grasping the bolt handle and

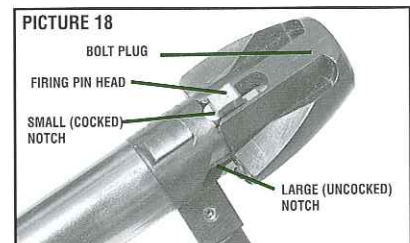

rotating upward 1/4th of a turn, moving the firing pin head from the small (cocked) notch to the large (uncocked) notch. See Picture 18.

4. Make sure the firing pin head is clear of the bolt plug. The bolt plug should rotate freely.
5. Turn bolt plug counter-clockwise 1/4th of a turn or until the bolt plug will lift off the assembly. See Picture 19.

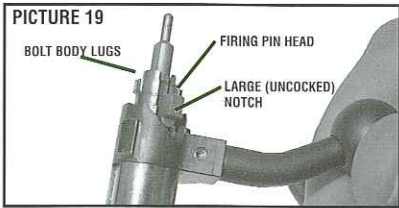

6. Slide the firing pin assembly out from the bolt assembly housing. See Picture 20.

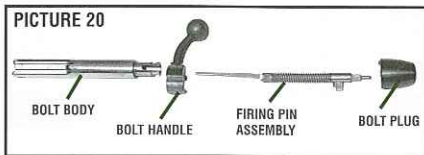

CAUTION: Clean the firing pin assembly as a unit.

7. Clean all parts with gun cleaning solvent. Such as Rem™ Action Cleaner. Dry with clean cloth.
8. Apply a thin coat of Rem™ Oil to firing pin assembly.

To Reassemble the Bolt Assembly:

1. Place the bolt handle onto the bolt body. Bolt handle should sweep rearward. See Picture 20.
2. Place firing pin assembly into the rear of the bolt body. Align firing pin head with slot in bolt body.
3. Align the firing pin assembly into the large (uncocked) notch of the bolt handle assembly. See Picture 19.
4. Align the lugs on the bolt body with the slots inside the bolt plug. See Picture 21.
5. Align the firing pin assembly with the bolt plug slot by rotating the bolt plug 1/4th turn in the clockwise direction. See Picture 22.

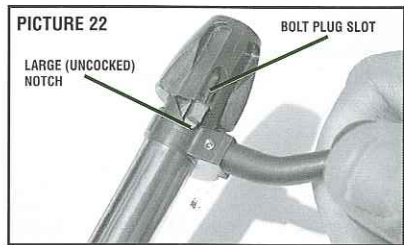
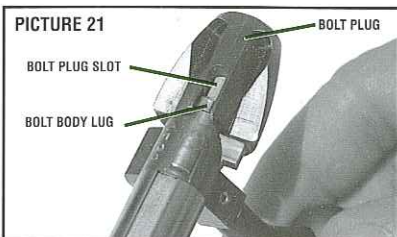

Note: You may need to grasp with a clean dry cloth to aid with grip.

6. Grasp bolt with a clean dry cloth, with one thumb placed on the bottom of the bolt and the other hand holding the bolt handle.
7. While gripping the bolt body firmly, cock the bolt by grasping the bolt handle and rotating downward 1/4th of a turn, moving the firing pin head from the large (uncocked) notch to the small (cocked) notch. See Picture 23.

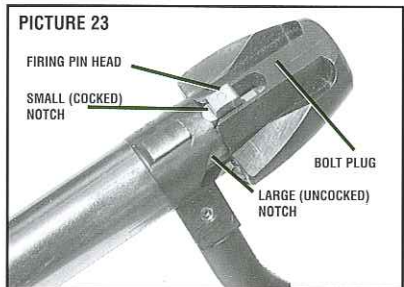

To Reassemble The Firearm:

WARNING! Visually check the chamber and magazine box to make sure there are no cartridges anywhere in the firearm.

1. Engage the safety mechanism by placing the safety arm in the "S" or "SAFE" position.
2. Place the action into the stock.
3. Insert the front and rear takedown screws.
4. Tighten both takedown screws, using a 1/8" Allen Wrench (Recommended torque 30 - 35 in-lb).
5. The magazine may be placed back into the firearm.

WARNING! Before you replace the bolt assembly, make sure the barrel is free of obstructions.

6. Replace the bolt assembly. See Instructions on page 8.

MODEL 504™

Bolt Action Rimfire Rifle (Exploded View)

MODEL 504™

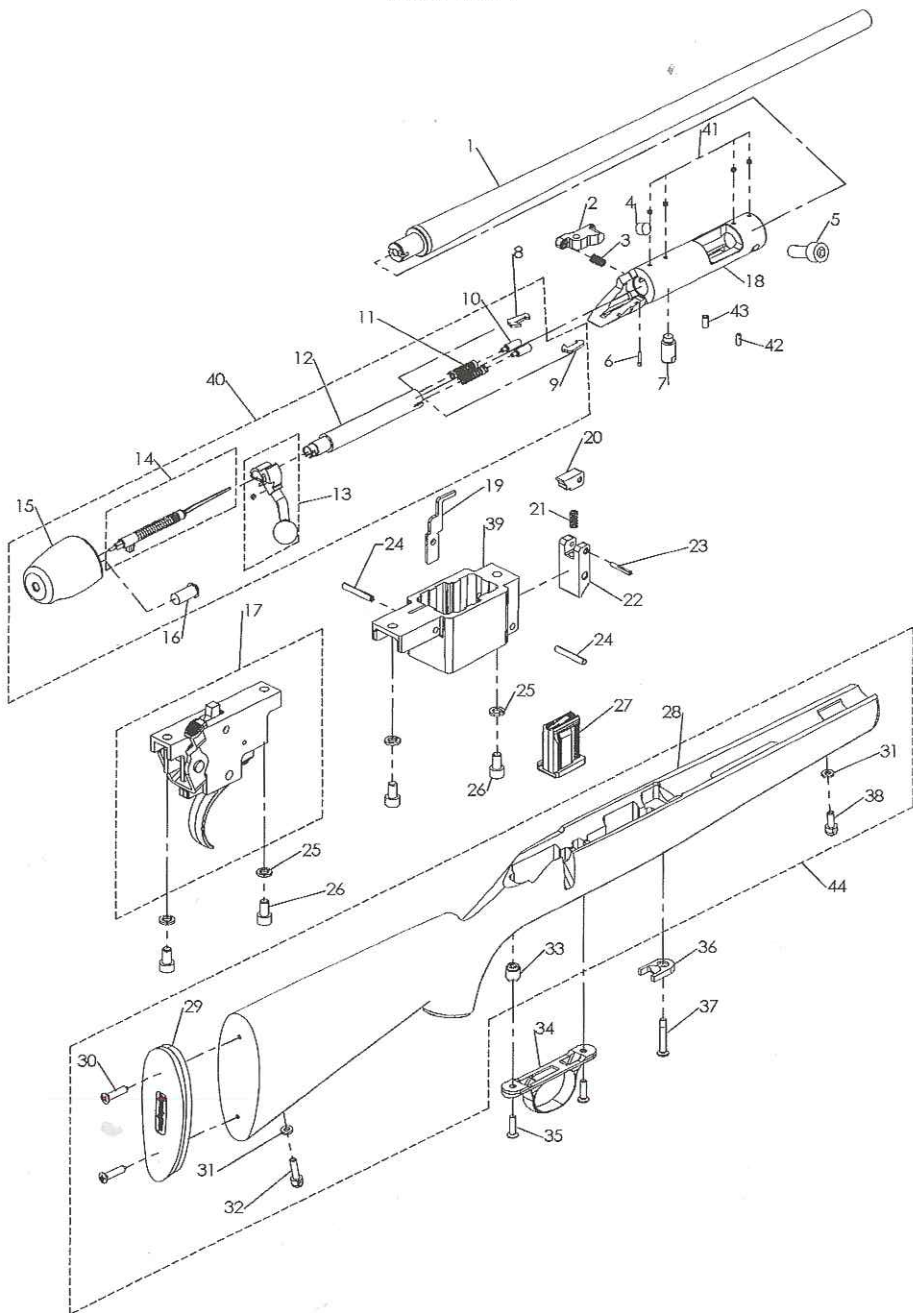

Schematic is provided for part identification only and should not be used as a guide to assemble the firearm.

MODEL 504™

Bolt Action Rimfire Rifle {Parts List}

MODEL 504™

ITEM NO.	PART NAME	ITEM NO.	PART NAME
1	Barrel (Restricted)	23	Magazine Latch Pin
2	Bolt Stop	24	Magazine Housing Pin (2)
3	Bolt Stop Spring	25	Housing Screw Lock Washer (4)
4	Barrel Set Screw	26	Housing Screw (4)
5	Barrel Clamp Screw (Restricted)	27	Magazine Box Assembly
6	Bolt Stop Pin	28	Stock
7	Recoil Lug	29	Rubber Butt Pad
8	Left Extractor	30	Recoil Pad Screw (2)
9	Right Extractor	31	Swivel Spacer (2)
10	Extractor Plunger (2)	32	Rear Swivel Stud
11	Extractor Spring(2)	33	Trigger Guard Screw Insert
12	Bolt Body (Restricted)	34	Trigger Guard
13	Bolt Cam Lock Assembly (Restricted)	35	Trigger Guard / Take down Screw (2)
14	Firing Pin Assembly	36	Escutcheon
15	Bolt Plug	37	Front Takedown Screw
16	Bolt Plug Ball Plunger	38	Front Swivel Stud
17	Trigger Assembly (Restricted)	39	Magazine Housing
18	Receiver (Restricted)	40	Bolt Assembly
19	Ejector	41	Receiver Plug Screw (4)
20	Magazine Latch	42	Barrel Guide Pin
21	Magazine Latch Spring	43	Magazine Release Pin
22	Magazine Release	44	Stock Assembly

How to Obtain Parts and Service From Remington® Arms Co.

To Order Parts:

Many Remington® Dealers and Authorized Repair Centers carry a full line of parts. Please check with them first before ordering parts.

To expedite your PARTS order or request REPAIR SERVICE visit our web site at www.remington.com. Detailed instructions are provided along with parts and/or service order forms. You may also reach Remington by calling our toll free customer service number, 1-800-243-9700, Mon.-Fri., 9:00 AM-5:00 PM Eastern time.

1. Fax completed order form (from the web site) to 1-336-548-7801.
2. To order by phone without the order form call 1-800-243-9700.

Please have the following information ready before you call.

- Firearm model and serial number.
- Part description and quantity. Part descriptions can be found on the parts listing page 17 in this manual.
- Your complete mailing address (P.O. Box and Street Address) including zip code, telephone number and e-mail address.
- Method of payment: MasterCard, Visa, Amex or Discover card number and expiration date. Prepayment may be made by check or money order. A quote may be made to you over the phone. (Sorry, no C.O.D.s.)

WARNING! USE ONLY REMINGTON PARTS IN REMINGTON FIREARMS.

NOTE: SOME PARTS MAY BE RESTRICTED.

See parts list for details. Owner's manuals/instruction books may be requested via our web site at: www.remington.com or by calling 1-800-243-9700.

Repair Services

1. To locate the Remington Authorized Repair Center nearest you visit our web site at www.remington.com and use our Repair Service Locator. If you need additional on-line assistance, e-mail us at info@remington.com to obtain a listing of Authorized Repair Centers. Contact the Authorized Repair Center of your choice for evaluation of your firearm and/or additional shipping instructions.
2. If your Remington Authorized Repair Center cannot provide the service or repair you require and you need further assistance, please call our toll free number 1-800-243-9700, Mon.-Fri., 9:00 AM-5:00 PM Eastern time and select the option for repairs. Then, if shipment of your firearm is required, please:

- Record the serial number of your firearm before sending it to us.
- Pack your firearm for safety and to prevent further damage in shipping and handling. Preferably, ship in a firearm box.
- Remove all accessories from the firearm to prevent loss or damage.
- Enclose a letter with the firearm detailing the model name or number of your firearm and serial number along with a full description of the problem. Be sure to include your full name and address (P.O. Box and Street Address), including zip code, daytime telephone number and e-mail address.
- Ship your firearm by either United Parcel Service (UPS) or Parcel Post (US Post Office). Remington is not responsible for damage or loss during shipment, so you may elect to purchase insurance from your carrier.

Ship to: Remington Arms Company, Inc.
Attn: Arms Service Division/Repairs
14 Hoefler Ave.
Ilion, NY 13357

WARNING! DO NOT SEND LIVE OR SPENT SHELLS IN YOUR FIREARM OR IN THE SAME BOX WITH THE FIREARM. THIS IS A VIOLATION OF FEDERAL LAW. IF YOU FEEL YOU MUST SEND SPENT SHELLS, PLEASE SEND THEM IN A SEPARATE PACKAGE AND INCLUDE NAME, ADDRESS (WITH ZIP CODE), TELEPHONE NUMBER, MODEL AND SERIAL NUMBER OF YOUR FIREARM.

Firearm Owner's Record

Model _____ Serial # _____ Date Purchased _____

Purchased From _____ Price Paid _____

Remember to complete and return the Firearm Warranty Registration Card in order to obtain full benefit of your Limited Two Year Firearm Warranty.

A WORD ON THE MAINTENANCE AND CARE OF YOUR REMINGTON FIREARM

Don't Alter or Modify Your Gun and Have it Serviced Regularly.

Your firearm has been designed to operate according to certain factory specifications. You'll jeopardize your safety and that of others around you by attempting to alter its trigger, mechanical safety or other mechanisms. Never alter or modify your firearm in any way.

Like any mechanical device, a firearm is subject to wear. It must be maintained and periodically serviced to assure optimum safety and performance. Only a qualified service facility should service, repair or modify your Remington® firearm. Consult your instruction book for location of the nearest Remington repair station. Remington recommends that you have your

firearm professionally serviced annually. You should also have your firearm professionally serviced after prolonged storage, or if there is ever any question pertaining to the proper functioning characteristics of your firearm.

Proper cleaning and lubrication are also important to firearm maintenance and are necessary to assure accuracy, safety and reliability. Before cleaning, always make sure that your gun is completely unloaded. And always clean the barrel from the chamber end to the muzzle when possible.

Firearm Maintenance Record

DATE	SERVICE PERFORMED	PERFORMED BY

MODEL 504™
Bolt Action Rimfire Rifle

Remington®

REMINGTON IS A TRADEMARK REGISTERED IN THE UNITED STATES PATENT
AND TRADEMARK OFFICE BY REMINGTON ARMS COMPANY, INC.

PRINTED IN THE U.S.A.

FORM RD 7066 09.03 ORIG