



FN 509[®]

Series

...

**AUTOLOADING PISTOL
OWNER'S MANUAL**

Important operating instructions for:

FN 509® AUTOLOADING PISTOLS

If you have any questions or comments regarding your new firearm, please contact us.

FN Service Center
797 Old Clemson Rd
Columbia, SC 29229

1-800-635-1321
customerservice@fnamerica.com
www.fnamerica.com

Please use the space below to record information about your new firearm.

Model _____

Serial Number _____

Purchased From _____

Date of Purchase _____

This owner's manual has been created exclusively for the FN 509 series of pistols.

WARNINGS AND INSTRUCTIONS ARE DIFFERENT FOR EACH TYPE OF PISTOL. IF YOUR FN PISTOL DOES NOT HAVE 509 IN ITS NAMING CONVENTION OR IF THE APPEARANCE OF THE PISTOL DOES NOT CORRESPOND TO THE ILLUSTRATIONS IN THIS OWNER'S MANUAL CONTACT YOUR DEALER, DEPARTMENT ARMORER OR CONTACT FN DIRECTLY TO OBTAIN THE OWNER'S MANUAL THAT HAS BEEN WRITTEN SPECIFICALLY FOR YOUR PISTOL.

©FN America, LLC All Rights Reserved

CONTENTS PAGE

1. Foreword	2	11.2 Reassembly from the field stripped condition	39
2. Basic safety rules	4	11.3 Backstrap removal	41
3. Ammunition	11	11.3.1 Backstrap installation	42
4. Dry firing & “dummy” rounds	13	11.4 Magazine disassembly	43
5. Nomenclature	13	11.4.1 Magazine reassembly	44
6. Loading and unloading	18	11.5 FN Optics Mounting System	45
6.1 Loading the magazine	18	11.6 Suppressor and muzzle device installation and use	48
6.2 Loading the pistol	20	11.7 Removing the magazine release	50
6.3 Unloading	22	11.7.1 Installing the magazine release	51
6.4 Unloading the magazine	24	12. Cleaning and lubrication	52
7. Firing	25	12.1 Cleaning and lubrication before firing	54
7.1 Reloading during firing	26	12.2 Cleaning and lubrication after firing	56
8. Function of the FN 509	28	13. FN 509 schematic and parts list	58
8.1 Firing cycle	28	13.1 FN 509 Standard Model	58
9. FN 509 features	28	13.2 FN 509 Tactical Model slide assembly unique parts	62
9.1 Passive safety systems	28	14. Warranty, service and technical questions	66
9.2 Manual safety	30	15. Technical specs	68
9.3 Ambidextrous slide stop	32		
9.4 Magazine release	32		
9.5 Loaded chamber indicator	33		
9.6 Magazine	33		
9.7 Accessory mounting rail	34		
9.8 Threaded Barrel	34		
9.9 Interchangeable backstraps	35		
9.10 FN optics mounting system	35		
10. Sight alignment	35		
11. Disassembling and reassembling the pistol	36		
11.1 Field strip	36		

1. FOREWORD

ALWAYS KEEP THIS MANUAL WITH YOUR FIREARM. INCLUDE IT WITH THE PISTOL WHEN IT CHANGES OWNERSHIP OR WHEN IT IS LOANED OR PRESENTED TO ANOTHER PERSON.

***NOTICE!* THE MANUFACTURER AND/OR ITS LOCAL OFFICIAL DISTRIBUTORS ASSUME NO RESPONSIBILITY FOR PRODUCT MALFUNCTIONS OR PHYSICAL INJURY OR PROPERTY DAMAGE IN WHOLE OR IN PART FROM THE CRIMINAL, NEGLIGENT, IMPROPER, OR CARELESS USE OR HANDLING OF THE PRODUCT; THE USE OF RELOADED, HAND-LOADED OR RE-MANUFACTURED AMMUNITION; ABUSE OR NEGLECT OF THE PRODUCT; OR OTHER INFLUENCES AND ACTIONS BEYOND FN'S DIRECT AND IMMEDIATE CONTROL.**

▲WARNING

ALL FIREARMS HAVE LETHAL POTENTIAL. READ THE BASIC SAFETY RULES CAREFULLY AND UNDERSTAND THEM FULLY BEFORE HANDLING THIS FIREARM.

In addition to the basic safety rules there are other safety rules pertaining to the loading, unloading, disassembly, assembly and use of this firearm located throughout this manual.

▲WARNING

READ THE ENTIRE MANUAL CAREFULLY BEFORE USING THIS FIREARM. MAKE SURE THAT ANY PERSON USING OR WHO HAS ACCESS TO THIS FIREARM READS AND UNDERSTANDS ALL OF THIS MANUAL BEFORE USE OR ACCESS.

▲WARNING

IT IS YOUR RESPONSIBILITY TO KNOW AND ABIDE BY FEDERAL, STATE AND LOCAL LAWS GOVERNING THE SALE, TRANSPORTATION, OWNERSHIP, POSSESSION, AND USE OF FIREARMS IN YOUR AREA.

CALIFORNIA STATE WARNING, SAFETY AND WARRANTY NOTES

According to state law, California requires that firearms manufacturers, distributors and retailers include conspicuous, specific warnings with firearms sold in that state.

▲WARNING

“Children are attracted to and can operate firearms that can cause severe injuries or death. Prevent child access by always keeping guns locked away and unloaded when not in use. If you keep a loaded firearm where a child obtains and improperly uses it, you may be fined or sent to prison.”

▲ADVERTENCIA

“A los niños los atraen las armas de fuego y las pueden hacer funcionar. Ellos pueden causarse lesiones graves y la muerte. Evite que los niños tengan acceso a las armas de fuego guardándolas siempre con llave y descargadas cuando no las esté utilizando. Si usted tiene un arma de fuego cargada en un lugar en que un niño tiene acceso a ella y la usa indebidamente, le pueden dar una multa o enviarlo a la cárcel.”

2. BASIC SAFETY RULES



READ THIS MANUAL BEFORE HANDLING YOUR FIREARM.

WARNING: FIREARMS CAN BE DANGEROUS AND CAN CAUSE SERIOUS INJURY, DAMAGE TO PROPERTY OR DEATH, IF HANDLED IMPROPERLY. THE FOLLOWING SAFETY RULES ARE IMPORTANT REMINDERS THAT AS A FIREARMS OWNER SAFETY IS YOUR RESPONSIBILITY. THERE IS NO EXCUSE FOR CARELESS OR ABUSIVE HANDLING OF ANY FIREARM. HANDLE THIS FIREARM AND ALL OTHER FIREARMS WITH RESPECT FOR THEIR POWER AND POTENTIAL DANGER AT ALL TIMES.

- 1. ALWAYS KEEP THE MUZZLE OF YOUR FIREARM POINTED IN A SAFE DIRECTION, EVEN IF YOU ARE CERTAIN IT IS UNLOADED.**

Never point any firearm at anything you do not intend to shoot even if you are certain it is unloaded. Stay alert and be aware of all persons and property within the range of your ammunition.

- 2. NEVER RELY TOTALLY ON YOUR FIREARM'S MECHANICAL "SAFETY" DEVICES. LIKE ANY MECHANICAL DEVICE, A "SAFETY" CAN SOMETIMES FAIL; IT CAN BE JARRED OR INADVERTENTLY MANIPULATED INTO AN UNSAFE CONDITION.**

Remember, safe gun handling does not stop with your firearm's mechanical "safety" devices, it starts there. Always treat this firearm with the respect due a loaded, ready-to-fire firearm.

The word "safety" describes a firearm's trigger block mechanism, sear block mechanism, hammer block mechanism or striker block mechanism. Mechanical "safeties" are designed to place your firearm in a safer status, and no guarantee can be made that the firearm will

not fire even if the “safety” is in the on “safe” position. Mechanical “safeties” merely aid safe gun handling and are no excuse for pointing your firearm’s muzzle in an unsafe direction.

Some firearms do not have a mechanical safety. Many target firearms, lever-action firearms and pistols do not have manual “safety” mechanisms. Therefore, it is critical to read and understand the owner’s or operator’s manual for every firearm that you use, which explains the safe operation of the firearm.

While it is a good idea to test your firearm’s mechanical “safety” periodically for proper function, never test the “safety” while your firearm is loaded or pointed in an unsafe direction.

See Section 9 for instructions on the operation of this firearm’s “safety” mechanisms.

3. KEEP YOUR FINGERS AWAY FROM THE TRIGGER AT ALL TIMES UNTIL SHOOTING IS IMMINENT.

4. KEEP ALL FIREARMS UNLOADED DURING TRANSPORT, EVEN WHEN STORED IN A HOLSTER, GUN CASE, SCABBARD OR OTHER CONTAINER.

For law enforcement, military personnel and authorized individuals, refer to the procedures of your organization or to the state and local laws and guidelines on carrying a loaded firearm.

5. BE SURE OF YOUR TARGET AND BACKSTOP

Clearly identify your target and what is beyond. Know the range of your ammunition and where the bullet will land if the target is missed or the bullet penetrates the target. Special care must be taken when shooting in any condition which makes identification of the target or backstop harder to assess, including low light conditions.

Never shoot at water or hard objects. Shooting at the surface of water or at rock or other hard surfaces increases the chance of ricochets or

fragmentation of the bullet which can result in the bullet striking an unintended target.

6. WHENEVER YOU HANDLE ANY FIREARM, OR HAND IT TO SOMEONE, ALWAYS OPEN THE ACTION IMMEDIATELY AND VISUALLY CHECK THE FIREARM'S CHAMBER AND MAGAZINE TO MAKE CERTAIN THAT THE FIREARM IS COMPLETELY UNLOADED.

Completely unload your firearm as described in Section 6. Make certain the firearm does not inadvertently contain any ammunition. Remember, merely removing the magazine does not mean the chamber is unloaded. Always keep the chamber empty and your fingers away from the trigger unless shooting is imminent.

7. STORE YOUR FIREARM AND AMMUNITION SEPARATELY, WELL BEYOND THE REACH OF CHILDREN.

Store all firearms in secure, locked cases or a gun safe and store ammunition separately from your firearms. Keep your firearm unloaded when not in use. Take prudent safeguards to ensure your firearm does not become available to children, untrained, inexperienced or unauthorized people. At all times, comply with local and state laws concerning the possession and storage of firearms.

8. USE ONLY THE PROPER AMMUNITION FOR YOUR FIREARM.

Use only factory-loaded, new ammunition manufactured to SAAMI or CIP specifications. Be certain that each round you use is of the proper caliber or gauge and type for the particular firearm. The caliber of the FN 509 is located on the rear of the barrel and is visible through the ejection port. The use of reloaded or remanufactured ammunition increases the likelihood of case head ruptures or other defects in the ammunition that can cause damage to your firearm and serious injury to yourself or others nearby.

9. PROPERLY MAINTAIN YOUR FIREARM, PRACTICE PERIODIC MAINTENANCE AND AVOID UNAUTHORIZED SERVICING.

Store and carry your firearm so debris does not accumulate in the working parts. Clean and oil your firearm following the instructions provided in this manual after each use to prevent corrosion damage or accumulation of debris. Make sure that no obstructions remain in the barrel. Firing the pistol with an obstruction in the barrel can cause extensive damage to your firearm and serious injury to yourself and others.

⚠WARNING

DO NOT, UNDER ANY CIRCUMSTANCES, ALTER THE TRIGGER, SAFETY OR OTHER PARTS OF THE FIRING MECHANISM OF THIS OR ANY OTHER FIREARM. FAILURE TO OBEY THIS WARNING MAY RESULT IN INJURY OR DEATH TO YOURSELF OR OTHERS.

Your firearm is a mechanical device and as such, is subject to wear and requires periodic inspection and service. FN firearms should only be serviced by the FN Product Service Center or FN authorized individual. FN cannot assume any responsibility for injuries suffered or damage caused by unauthorized servicing, alterations or modifications of FN firearms.

10. ALWAYS WEAR EYE AND HEARING PROTECTION WHEN SHOOTING.

Unprotected, repeated exposure to gunfire can cause hearing damage. Wear hearing protection (shooting earplugs or ear muffs) to guard against such damage.

Wear shooting glasses to protect your eyes from flying particles. Allow proper distance (also known as eye relief) between a scope and your eye when firing a scoped pistol, rifle or shotgun. Do not use unorthodox shooting methods that could cause the rearward travel of the slide or bolt of a firearm to contact your eyes, face or hands. Always keep a safe distance between the muzzle and ejection port of your firearm and any persons nearby, as muzzle blast, debris and ejecting shells could inflict serious injury.

Always wear appropriate eye protection when disassembling and cleaning your pistol to prevent the possibility of springs, spring-tensioned parts, solvents or other agents from contacting your eyes.

11. AVOID DROPPING FIREARMS OR SHOOTING FROM UNSTABLE POSITIONS.

Shooting from unstable positions is dangerous. Doing so increases the risk of falling or dropping the firearms. The following rules should always be observed. Always make certain that your firearm is unloaded when climbing or navigating obstacles and ensure that the surface that you are firing the pistol from is safe and stable. Dropping a pistol from an elevated position increases the risk of damage or unintended discharge.

▲WARNING

DROPPING OR JARRING A LOADED FIREARM CAN CAUSE THE FIREARM TO DISCHARGE. BE EXTREMELY CAREFUL DURING ANY SHOOTING ACTIVITY OR WHEN CARRYING ANY FIREARM TO AVOID DROPPING IT.

12. BE ALERT TO THE SIGNS OF AMMUNITION MALFUNCTION.

If a cartridge has a different sound or lighter recoil than normal, do not load another cartridge into the chamber. If your firearm fails to fire, keep the muzzle pointed in a safe direction for a minimum of 30 seconds. Rotate the ejection area of the firearm away from you, carefully open the action and remove the cartridge from the chamber.

If the primer is indented, the defective cartridge should be disposed of in a way that cannot cause harm. If the primer is not indented, your firearm should be examined by a qualified gunsmith and the cause of the malfunction corrected before further use. Inspect the barrel following the instructions in section 6.3.

Beware of barrel obstructions, field strip the pistol following the

instructions in section 11.1 and inspect the barrel for obstructions before shooting. Never inspect the barrel while the firearm is loaded or prior to complete field stripping. Mud, snow and an infinite variety of other objects may inadvertently lodge in a barrel bore. If an obstruction is seen, no matter how small it may be, clean the bore with a cleaning rod and patch as described in section 12.1 of this manual. It only takes a small obstruction to cause dangerously increased pressures that can damage your firearm and cause serious injury or death to yourself and others.

13. WHEN DISCHARGING A FIREARM, MAKE SURE THAT THE AREA HAS ADEQUATE VENTILATION.

Exposure to lead and other toxic chemicals can occur from discharging firearms in poorly ventilated areas, cleaning firearms or handling ammunition. Lead is a substance that has been known to cause birth defects, reproductive harm and other serious injury. Wash hands thoroughly after exposure to ammunition or after cleaning a firearm.

14. BE DEFENSIVE AND ON GUARD AGAINST UNSAFE GUN HANDLING AROUND YOU AND OTHERS.

Don't be timid when it comes to gun safety. If you observe other shooters violating any of these safety precautions, politely suggest safer handling practices.

15. BE CERTAIN YOUR FIREARM IS UNLOADED BEFORE CLEANING.

Because so many gun accidents occur when a firearm is being cleaned, special care should be taken to ensure your firearm is unloaded before disassembly, cleaning and reassembly. Keep ammunition and other flammable or dangerous objections away from the cleaning location. Never test the mechanical function of any firearm with live ammunition.

16. TEACH AND SUPERVISE FIREARMS SAFETY TO ALL MEMBERS OF YOUR HOUSEHOLD, ESPECIALLY TO CHILDREN AND NONSHOOTERS.

Closely supervise newcomers to the shooting sports. Encourage enrollment in firearm and shooting safety courses.

17. NEVER DRINK ALCOHOLIC BEVERAGES OR TAKE JUDGEMENT/REFLEX IMPAIRING MEDICATION OR DRUGS BEFORE OR DURING SHOOTING.

Your vision, motor skills and judgment could be dangerously impaired, making your gun handling unsafe to you and to others.

18. READ AND HEED ALL WARNINGS IN THIS OWNER'S MANUAL, ON AMMUNITION BOXES AND WITH ALL ACCESSORIES THAT YOU INSTALL ON YOUR FIREARM.

It is your responsibility to secure the most up-to-date information on the safe handling procedures for your FN firearm. FN assumes no liability for incidents which occur when unsafe or improper pistol accessories or ammunition combinations are used.

NOTICE: FN RESERVES THE RIGHT TO REFUSE SERVICING A FIREARM WHICH HAS BEEN MODIFIED BY REMOVAL OF METAL FROM THE BARREL OR SLIDE, MODIFICATIONS OF THE FIRING MECHANISM AND/OR OTHER PARTS, AND WILL, IN SUCH A CASE, ALWAYS RECOMMEND RESTORING THE FIREARM TO ITS ORIGINAL SPECIFICATIONS. PARTS AND LABOR REQUIRED FOR SUCH A RESTORATION ARE PAYABLE BY THE OWNER OF THE FIREARM.

NOTICE: THIS PISTOL SHOULD BE CLEANED PRIOR TO USE FOLLOWING THE INITIAL CLEANING INSTRUCTIONS LOCATED IN SECTION 12.1 OF THIS MANUAL.

Various metal parts of your pistol have been coated at the factory with corrosion inhibitors and lubricants to protect the pistol during shipping and storage. Before using your pistol, clean the preservatives from the inside of the barrel, slide and action/chamber areas with a quality gun oil as explained in section 12.1. If your pistol is to be stored, it is acceptable to leave the preservatives on the pistol and keep it in its original packaging.

Never fire the pistol upon purchase without first inspecting cleaning and lubricating it before use. Pay special attention that all foreign material is removed from the bore of the barrel to prevent an unsafe condition.

3. AMMUNITION

AMMUNITION NOTICE: FN specifically disclaims responsibility for any damage or injury occurring with, or as a result of, the use of faulty, non-standard, remanufactured, hand-loaded or reloaded ammunition, or cartridges other than those for which the firearm was originally chambered. Serious damage, injury or death could result from the use of incorrect ammunition, from firing against a bore obstruction or from propellant overloads. Use of improper ammunition, such as listed previously will void the manufacturer's warranty. Use only commercially manufactured ammunition made in accordance with SAAMI (Sporting Arms and Ammunition Manufacturers' Institute) or CIP (Commission internationale permanente pour l'épreuve des armes à feu portatives "Permanent International Commission for the Proof of Small Arms") standards. Be certain that the ammunition is the appropriate caliber and loading for the firearm and is clean, dry and in good condition. The caliber of your FN pistol is marked on the portion of the barrel visible through the ejection port.

▲WARNING

THE FN 509 IS DESIGNED TO SAFELY AND RELIABLY FUNCTION WITH +P AMMUNITION. THE AMMUNITION SOLD AS +P+ DOES NOT CONFORM TO SAAMI OR CIP GUIDELINES AND MAY DEVELOP CHAMBER PRESSURE IN EXCESS OF INDUSTRY STANDARDS. DO NOT USE +P+ AMMUNITION IN THE FN 509 AS IT COULD RESULT IN SERIOUS INJURY OR DEATH. DO NOT USE AMMUNITION SPECIFICALLY INTENDED FOR USE IN SUBMACHINE GUNS AS CHAMBER PRESSURE MAY REACH OR EXCEED THE PRESSURE DEVELOPED BY PROOF LOADS.

▲WARNING

CAREFULLY INSPECT EACH CARTRIDGE BEFORE IT IS LOADED IN THE MAGAZINE. BE CERTAIN THE CARTRIDGE CASE IS NOT SPLIT OR DEFORMED AND THAT THE CARTRIDGES DO NOT POSSESS ANY OTHER DENTS OR DEFECTS.

For best results, use new factory manufactured ammunition from a reputable manufacturer. Primers, powder, cartridge cases and bullets can deteriorate with time and cause damage to the firearm or injury to the shooter or others.

▲WARNING

LEAD BULLETS HAVE A TENDENCY TO CAUSE BORE LEADING, WHICH MAY DRAMATICALLY INCREASE PRESSURE WHEN A MORE RIGID BULLET DESIGN IS FIRED IN THE LEADED BORE. BE SURE TO REMOVE ALL CHAMBER AND BORE LEAD ACCUMULATION AFTER EACH USE. DO NOT SHOOT CARTRIDGES WITH JACKETED OR MONOLITHIC BULLETS THROUGH A BARREL PREVIOUSLY FIRED WITH LEAD BULLETS BEFORE THE BORE IS THOROUGHLY DELEADED.

CAUTION: STORE ALL CARTRIDGES OF DIFFERENT CALIBERS IN COMPLETELY SEPARATE AND WELL-MARKED CONTAINERS. NEVER STORE CARTRIDGES OF MIXED CALIBERS IN A COMMON CONTAINER OR IN YOUR POCKETS.

FN has gone to great lengths to ensure the compatibility of the FN 509 with the widest possible range of ammunition but due to the vast and ever increasing number and types of ammunition available it is recommended that you test your pistol with any ammunition that you wish to carry for protection to ensure reliable functioning.

If you have concerns about the compatibility of a particular ammunition type with your FN pistol, contact FN customer service before using any such ammunition.

4. DRY FIRING & “DUMMY” ROUNDS

Dry firing is defined as firing a firearm with no ammunition in the chamber. Occasional dry firing of your FN 509 and for disassembly is acceptable. Regularly dry firing your FN 509 pistol for practice or training may result in damage to the striker. “Snap Caps” (inert chamber inserts that allow a firearm to be dry fired without damaging the firing pin) are commercially available for those who wish to practice firing without live ammunition.

CAUTION: Always keep the muzzle of your firearm pointed in a safe direction, even if you are certain it is unloaded.

CAUTION: Store inert ammunition separately from loaded ammunition to avoid unintended firing of the pistol. Failure to follow this warning could result in serious injury or death.

CAUTION: “Dummy Rounds” with empty primer pockets are suitable for loading/unloading practice and some training activities but do not protect the striker during dry firing.

5. NOMENCLATURE

In conventional gun terminology, the position and movement of parts are described as they occur with the firearm horizontal and in the normal firing position: the muzzle is forward or front, the pistol grip is rearward or rear, the trigger is downward or underneath, the sights are upward or on top. For general parts nomenclature refer to Figures 1 and 2.

The illustrations in this manual depict the FN 509 series pistol. Some variations may not be shown.

FIGURE 1

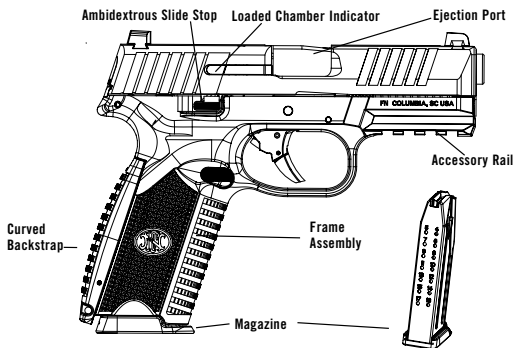

Right view of the FN 509 pistol (non-manual safety model shown).

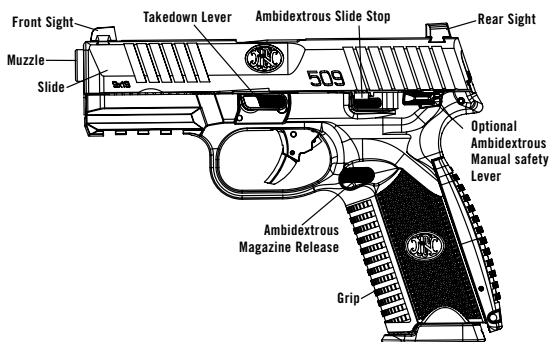

Left view of the FN 509 pistol (manual safety model shown).

FIGURE 2

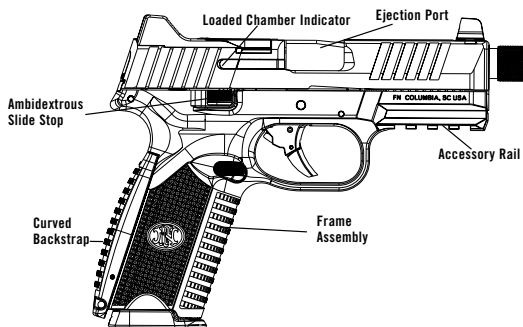

Right view of the FN 509 Tactical pistol (non-manual safety model shown).

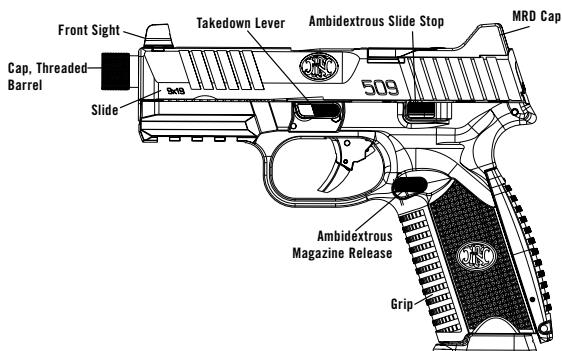

Left view of the FN 509 Tactical pistol (non-manual safety model shown).

BEFORE HANDLING, STORING OR TRANSPORTING YOUR PISTOL, FOLLOW THESE PROCEDURES TO ENSURE THE PISTOL IS UNLOADED.

▲WARNING

ALWAYS KEEP THE MUZZLE OF YOUR FIREARM POINTED IN A SAFE DIRECTION. KEEP YOUR FINGERS AWAY FROM THE TRIGGER UNTIL READY TO SHOOT. FAILURE TO FOLLOW THESE WARNINGS COULD RESULT IN SERIOUS INJURY OR DEATH.

1. Depress the magazine release to eject the magazine. If the magazine does not eject from the magazine well, press and hold the magazine release while gently pulling on the magazine floor plate (Figure 3).
2. If the slide is closed, pull the slide back and eject the cartridge from the chamber if one was chambered. Lock the slide to the rear by pressing the slide stop up and allowing the slide to rest against the slide stop retaining it to the rear (Figure 4).

FIGURE 3

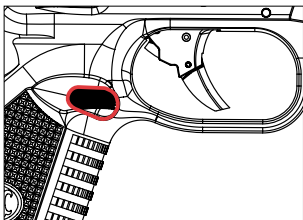

Depress magazine release.

FIGURE 4

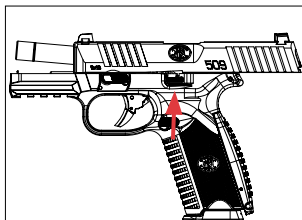

Lock slide open.

3. Inspect the chamber and magazine well to ensure no cartridge is present. Remember, merely removing the magazine does not mean the chamber is unloaded (Figure 5).

4. Release the slide by pushing downward on the slide stop or by pulling rearward on the slide to disengage the slide stop and then let the slide move forward under control (Figure 6).

FIGURE 5



Empty chamber.

FIGURE 6

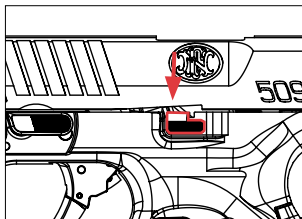

Slide released.

5. Ensure that the magazine is empty. If the magazine is not empty, unload it as described in Section 6.4. Unload any spare magazines.

CAUTION: THE RECOMMENDED CARRY CONDITION OF YOUR PISTOL IS WITH THE CHAMBER EMPTY. FOR GOOD SAFETY PRACTICE, IT IS RECOMMENDED THAT A CARTRIDGE NOT BE CHAMBERED UNTIL USE IS IMMINENT. ONCE A CARTRIDGE IS CHAMBERED, EXTRA CAUTION MUST BE EXERCISED TO ENSURE NOTHING COMES IN CONTACT WITH THE TRIGGER. IF THE PISTOL IS EQUIPPED WITH A MANUAL SAFETY THE SAFETY SHOULD BE ENGAGED WHEN A ROUND IS CHAMBERED AND REMAIN ENGAGED UNTIL READY TO SHOOT. FAILURE TO FOLLOW THESE WARNINGS COULD RESULT IN SERIOUS INJURY OR DEATH.

6. LOADING AND UNLOADING

WARNING

LOAD THE CHAMBER ONLY WHEN READY TO USE THE PISTOL.

WHENEVER A LIVE ROUND IS IN THE CHAMBER THE PISTOL CAN FIRE, EVEN IF THE MAGAZINE IS EMPTY OR HAS BEEN REMOVED.

WHEN LOADING YOUR PISTOL ALWAYS KEEP THE MUZZLE POINTED IN A SAFE DIRECTION AND KEEP YOUR FINGERS AWAY FROM THE TRIGGER. FAILURE TO FOLLOW THESE WARNINGS COULD RESULT IN SERIOUS INJURY OR DEATH.

MAKE SURE YOUR FINGERS ARE SAFELY AWAY FROM THE EJECTION PORT WHEN THE SLIDE IS RELEASED TO AVOID PINCHING THEM WHEN THE SLIDE CLOSES. FAILURE TO FOLLOW THIS WARNING COULD RESULT IN SERIOUS INJURY.

6.1 LOADING THE MAGAZINE

WARNING

INSERT THE MAGAZINE INTO THE PISTOL AND LOAD A CARTRIDGE INTO THE CHAMBER ONLY WHEN READY TO FIRE. IF THE PISTOL IS EQUIPPED WITH A MANUAL SAFETY THE SAFETY SHOULD REMAIN IN THE ENGAGED POSITION UNTIL READY TO FIRE.

WARNING

USE ONLY AMMUNITION THAT IS OF THE APPROPRIATE CALIBER AND LOADING FOR THE FIREARM TO BE USED AND IS CLEAN, DRY AND IN GOOD CONDITION. THE CALIBER OF YOUR FN PISTOL IS MARKED ON THE PORTION OF THE BARREL VISIBLE THROUGH THE EJECTION PORT.

If the magazine to be loaded is still in the pistol, depress the magazine release and remove the magazine from the pistol.

Hold the magazine in one hand. With the other hand, place a cartridge on the magazine follower or on the cartridge case of the previously loaded round in the magazine in front of the feed lips at the top of the magazine. Press the cartridge down into the magazine body and slide the cartridge under the feed lips until it is seated fully inside the magazine body.

Repeat the process until the magazine is fully loaded. The holes on the back of the magazine body allow you to estimate the number of cartridges present in the magazine (Figure 7).

FIGURE 7

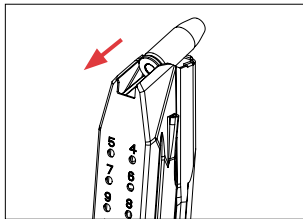

Loading the magazine.

CAUTION: DO NOT TRY TO FORCE MORE THAN THE MAXIMUM NUMBER OF ROUNDS INDICATED FOR YOUR PARTICULAR MAGAZINE INTO THE MAGAZINE. ATTEMPTING TO OVERLOAD THE MAGAZINE CAN DAMAGE IT CAUSING THE PISTOL TO MALFUNCTION.

6.2 LOADING THE PISTOL

⚠ WARNING

WHEN LOADING YOUR PISTOL, ALWAYS KEEP THE MUZZLE POINTED IN A SAFE DIRECTION AND KEEP YOUR FINGERS AWAY FROM THE TRIGGER. ALWAYS CLOSE THE SLIDE BEFORE INSERTING A LOADED MAGAZINE IF YOU DO NOT WISH TO IMMEDIATELY CHAMBER A CARTRIDGE. FAILURE TO FOLLOW THESE WARNINGS COULD RESULT IN SERIOUS INJURY OR DEATH.

1. Before loading, ensure that the chamber of the pistol is empty and the pistol does not contain a magazine. Close the slide if you do not wish to immediately chamber a cartridge (Figure 8).
2. Insert the loaded magazine into the pistol, making certain that the magazine is pressed completely in and is retained by the magazine release (Figure 9).

FIGURE 8

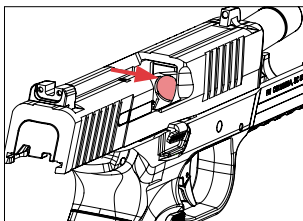

Empty chamber.

FIGURE 9

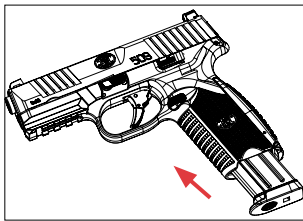

Insert magazine.

FIGURE 10

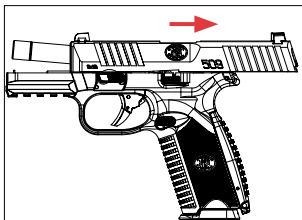

Retract slide.

FIGURE 11

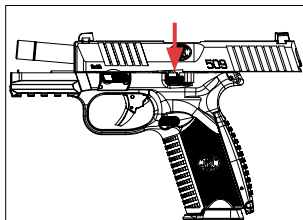

Depress slide stop lever.

3. With the muzzle pointed in a safe direction and your fingers away from the trigger, hold the pistol in your firing hand and pull the slide fully rearward with the other hand and release the slide, which will return under the force of the recoil spring (Figure 10-11). You can also press down on the slide stop to allow the slide to move forward and chamber a cartridge if the slide is locked to the rear. This movement resets the firing mechanism and moves the first cartridge from the magazine into the chamber. Allow the slide to “slam” forward under the force of the recoil spring. Do not ease it forward.

⚠ WARNING

THE PISTOL IS NOW READY TO FIRE. ALWAYS KEEP THE MUZZLE POINTED IN A SAFE DIRECTION AND KEEP YOUR FINGERS AWAY FROM THE TRIGGER UNTIL READY TO FIRE. FAILURE TO FOLLOW THESE WARNINGS COULD RESULT IN SERIOUS INJURY OR DEATH.

6.3 UNLOADING

▲WARNING

WHILE UNLOADING THE PISTOL, ALWAYS KEEP THE MUZZLE POINTED IN A SAFE DIRECTION AND KEEP YOUR FINGERS AWAY FROM THE TRIGGER. IF YOUR PISTOL IS EQUIPPED WITH A MANUAL SAFETY, THE SAFETY SHOULD BE IN THE ENGAGED POSITION. WHEN UNLOADING, IT IS VITAL THAT YOU REMOVE THE MAGAZINE FROM YOUR PISTOL SO THAT A CARTRIDGE IS NOT CHAMBERED WHEN YOU CLOSE THE SLIDE. FAILURE TO FOLLOW THESE WARNINGS COULD RESULT IN SERIOUS INJURY OR DEATH.

1. Press the magazine release and remove the magazine. If the magazine does not drop out of the pistol, pull on the magazine base plate while pressing the magazine release (Figure 12).
2. If the slide is closed, pull the slide back and eject the cartridge from the chamber. Lock the slide to the rear by pressing the slide stop up and allowing the slide to rest against the slide stop retaining it to the rear (Figure 13).

FIGURE 12

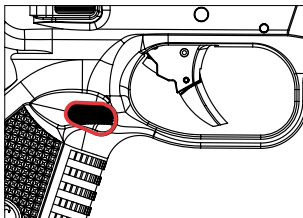

Depress magazine catch.

FIGURE 13

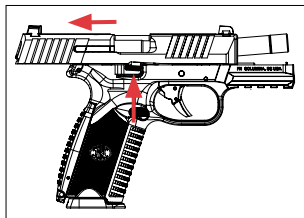

Lock slide open.

3. Inspect the chamber and magazine well to ensure no cartridge is present. Remember, merely removing the magazine does not mean the chamber is unloaded (Figure 14).

FIGURE 14

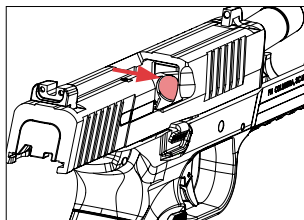

Empty chamber.

4. The slide should be left in the open position until ready to load or when putting the pistol away. To release the slide, pull rearward on the slide to disengage the slide stop or press down on the slide stop to allow the slide to move forward (Figure 15-16).

FIGURE 15

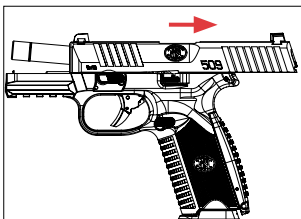

Retract slide.

FIGURE 16

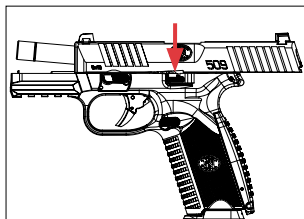

Depress slide stop lever.

5. Unload the magazine as explained in Section 6.4.

6.4 UNLOADING THE MAGAZINE

1. Depress the magazine release and remove the magazine (Figure 17).
2. Unload the pistol and place it in a safe condition as detailed in Section 6.3.
3. Strip the top cartridge from the magazine by pushing forward on the rim of the cartridge and slide the cartridge out from under the feed lips. When the cartridge is removed the remaining cartridges will move up in the magazine. Continue removing the cartridges in this manner until the magazine is empty. Repeat this procedure with all loaded magazines (Figure 18).

FIGURE 17

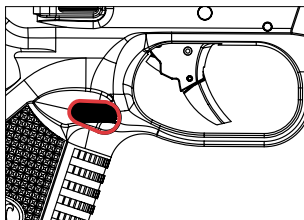

Depress magazine release.

FIGURE 18

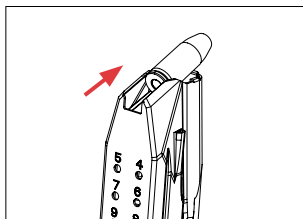

Remove rounds from magazine.

7. FIRING

⚠ WARNING

WHEN FIRING, THE SLIDE MOVES REARWARD PAST THE BACK OF THE FRAME. TO PREVENT THE SLIDE FROM CAUSING INJURY IN ITS REARWARD MOVEMENT WHEN SHOOTING, KEEP THE PISTOL AWAY FROM THE EYES OR FACE. KEEP YOUR HAND IN A POSITION WHERE THEY CANNOT BE HIT BY THE SLIDE. FAILURE TO FOLLOW THIS WARNING COULD RESULT IN SERIOUS INJURY.

1. Load a cartridge into the chamber as detailed in Section 6.2.
2. With a cartridge in the chamber disengage the manual safety if your pistol is so equipped, aim at your target and squeeze the trigger to fire the pistol (Figure 19).
3. After a cartridge has been fired, the slide moves rearward, ejects the empty cartridge case and returns forward resetting the firing mechanism and loading a cartridge from the magazine into the chamber. You may continue to fire the pistol until the magazine is empty by pulling the trigger to fire each cartridge. After the last cartridge in the magazine is fired, the slide stop will automatically engage the slide and hold the slide in the open (rearward) position (Figure 20).

FIGURE 19

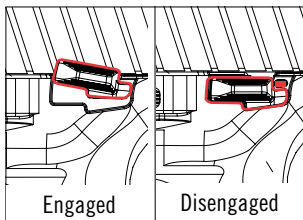

Manual safety.

FIGURE 20

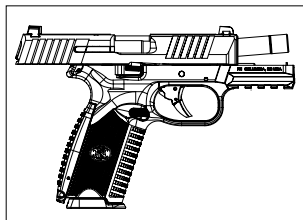

Slide locked open.

7.1 RELOADING DURING FIRING

▲WARNING

NEVER CHAMBER A CARTRIDGE UNLESS USE OF THE PISTOL IS IMMINENT. ALWAYS KEEP THE MUZZLE POINTED IN A SAFE DIRECTION. MAKE SURE YOUR FINGERS ARE SAFELY AWAY FROM THE CHAMBER WHEN THE SLIDE IS RELEASED TO AVOID PINCHING THEM WHEN THE SLIDE CLOSES. FAILURE TO FOLLOW THESE WARNINGS COULD RESULT IN SERIOUS INJURY OR DEATH.

After firing the last cartridge with the magazine inserted, the slide will remain in the open position. If firing is imminent, the empty magazine can quickly be replaced with a loaded magazine as follows:

1. Depress the magazine release to eject the empty magazine (Figure 21).
2. Insert a loaded magazine completely into the magazine well until it locks into position (Figure 22).

FIGURE 21

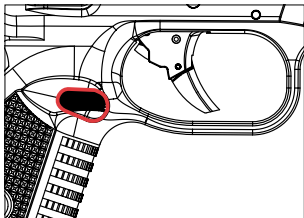

Depress magazine release.

FIGURE 22

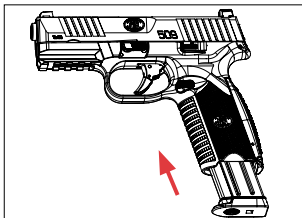

Insert magazine.

3. Release the slide by pulling rearward on the slide to disengage the slide stop and allow the slide to move forward and chamber a cartridge. You can also press down on the slide stop to allow the slide to move forward and chamber a cartridge. When the slide closes, the pistol is loaded and ready to fire. You may now continue firing (Figure 23-24).

FIGURE 23

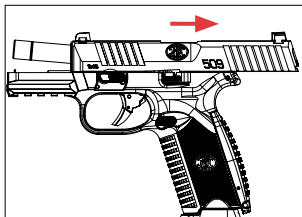

Retract slide.

FIGURE 24

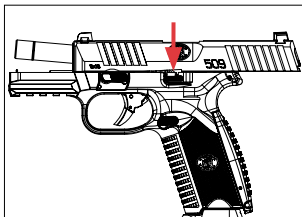

Depress slide stop lever.

If firing is no longer imminent and you are finished shooting, remove the magazine and pull the slide to the rear to eject the chambered round. Inspect the magazine well and chamber to ensure no ammunition remains in the pistol and allow the slide to return to the forward position.

8. FUNCTION OF THE FN 509

The FN 509 is a semi-automatic, locked-breach pistol. With the chamber and magazine loaded, the pistol will fire a single shot each time the trigger is pulled until the magazine and chamber are empty. The slide will remain locked to the rear after the last cartridge is fired.

8.1 FIRING CYCLE

When the trigger is pulled the striker block and trigger safety are disconnected and the striker is released to move forward and strike the primer of the loaded cartridge, firing the pistol. The energy generated from the firing of the cartridge moves the slide and barrel rearward, the barrel is unlocked from the slide after a short distance and stopped. The slide then continues rearward under inertia compressing the recoil spring and ejecting the fired cartridge case. As the breach face of the slide passes the back of the magazine in its rearward travel, the cartridges in the magazine rise under spring tension until the top round is in contact with the magazine feed lips. As the slide is returned forward by the recoil spring the top cartridge is stripped from the magazine by the slide and pushed into the chamber of the pistol. Releasing the trigger will allow the firing mechanism to reset and the process can be repeated until the magazine is empty. Upon firing the pistol with an empty magazine inserted, the magazine follower will push the slide stop into engagement with slide and lock the slide to the rear of its travel.

9. FN 509 FEATURES

9.1 PASSIVE SAFETY SYSTEMS

The FN 509 is equipped with four passive safety systems: a striker block; drop safety; trigger disconnect; and trigger safety lever, to prevent the pistol from firing unless the trigger is pulled and the slide and barrel are in the locked position.

- The striker block prevents the tip of the striker from protruding from the breach face unless the trigger has been pulled to the rear (Figure 25).

FIGURE 25

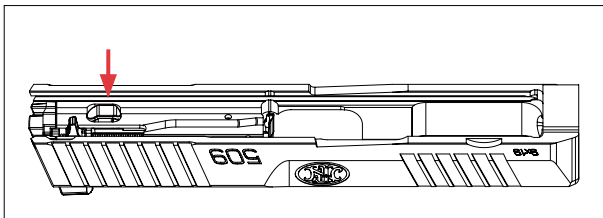

Striker block.

- The drop safety prevents the sear from moving down out of engagement with the striker unless the trigger has been pulled to the rear (Figure 26).
- The trigger disconnect safety is actuated when the disconnect cam is pushed out of alignment with the sear preventing the sear from releasing the striker. This safety feature prevents the pistol from firing out of battery (Figure 27).

FIGURE 26

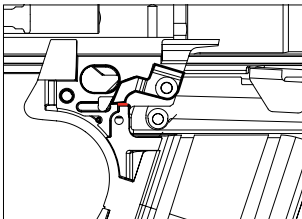

Drop safety.

FIGURE 27

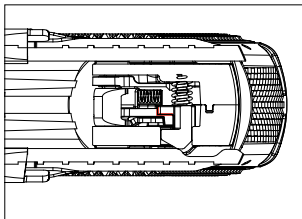

Trigger disconnect.

- The trigger safety remains engaged unless the shooter's finger is on the trigger and blocks the rearward movement of the trigger, preventing the trigger from moving rearward under inertia should the pistol be dropped (Figure 28).

FIGURE 28

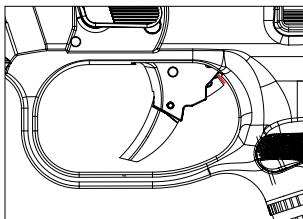

Trigger safety.

9.2 MANUAL SAFETY (APPLICABLE ONLY TO PISTOLS WITH A MANUAL SAFETY)

FIGURE 29

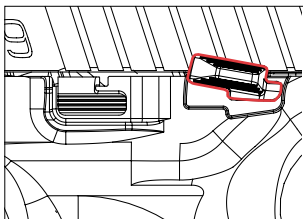

Safety engaged.

FIGURE 30

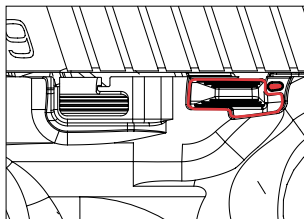

Safety disengaged.

Some FN 509 pistols may be equipped with a manually activated safety that prevents the pistol from firing unless it is deactivated. On FN 509 pistols equipped with a manual safety the safety levers will be located near the rear of the frame. When the safety levers are moved to the up position,

the safety is engaged and blocks the movement of the sear carrier and trigger assembly. When the safety levers are moved down the red dot indicating that the pistol will fire is exposed and the firing mechanism is free to operate. The safety lever is retained in the selected position by a detent and will snap into location when engaged or disengaged.

If the pistol is equipped with a safety, it is recommended that the safety be disengaged only when ready to fire the pistol or for disassembly.

CAUTION: THE RED DOT ON THE FRAME SHOULD NOT BE RELIED UPON TO INDICATE THE FIRING CONDITION OF THE PISTOL. THE DOT CAN BECOME OBSCURED OR DAMAGED PREVENTING IT FROM BEING SEEN.

***NOTICE!* THE SAFETY OF THE FN 509 CANNOT BE ENGAGED WHEN THE TRIGGER IS IN THE FIRED (REARWARD) POSITION.**

⚠ WARNING

NEVER RELY TOTALLY ON THE “SAFETY” MECHANISMS OF YOUR PISTOL. LIKE ANY OTHER MECHANICAL DEVICE, IT COULD FAIL OR BE JARRED OR INADVERTENTLY MANIPULATED INTO AN UNSAFE CONDITION, ESPECIALLY WHEN THE PISTOL IS SUBJECTED TO EXTREME FORCES OR CONDITIONS NOT ENCOUNTERED UNDER NORMAL SHOOTING CONDITIONS.

⚠ WARNING

ALWAYS KEEP THE MUZZLE OF YOUR FIREARM POINTED IN A SAFE DIRECTION. KEEP YOUR FINGERS AWAY FROM THE TRIGGER UNTIL READY TO SHOOT AND KEEP YOUR FIREARM UNLOADED UNTIL READY TO SHOOT. FAILURE TO FOLLOW THESE WARNINGS COULD RESULT IN SERIOUS INJURY OR DEATH.

9.3 AMBIDEXTROUS SLIDE STOP

The FN 509 slide stop is fully ambidextrous meaning that the control levers are located on both sides of the frame within easy reach of the thumb of the shooting hand and protected from unintentional activation by a guard located in front of and below the slide stop lever. The slide stop is automatically engaged when the last shot from a magazine is fired or the slide is retracted with an empty magazine in the pistol. To engage the slide stop without an empty magazine inserted, retract the slide and press up on the slide stop and hold it in that position while allowing the slide to move forward (Figure 31).

To release the slide from the slide stop, press down on the left or right slide stop lever and the slide will be released to close. The slide can also be released by pulling back and releasing the slide as long as an empty magazine is not present.

9.4 MAGAZINE RELEASE

The FN 509 magazine release is located on the frame behind the trigger. The release can be actuated by pressing the magazine release into the frame. The magazine release can be easily actuated by the thumb of the shooting hand and is protected by a guard that prevents inadvertent activation of the release and prevents the magazine release from being pressed if the pistol is dropped or pressed against a flat surface (Figure 32).

FIGURE 31

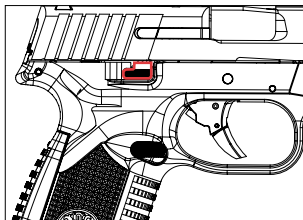

Slide stop lever.

FIGURE 32

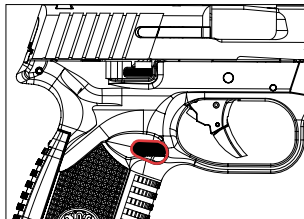

Magazine release.

9.5 LOADED CHAMBER INDICATOR

The loaded chamber indicator is located on the right side of the slide just behind the ejection port. When a cartridge is present in the chamber, the extractor is deflected by the case exposing a red dot on the slide directly above the slide stop and providing a tactile indication that the chamber is loaded when a finger is placed on the wide groove at the front of the rear slide serrations on the right side of the pistol (Figure 33).

FIGURE 33

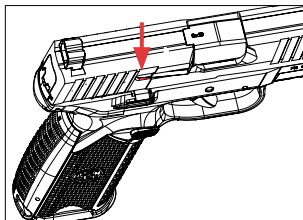

Loaded chamber indicator.

⚠ WARNING

THE RED DOT THAT INDICATES A LOADED CHAMBER CAN BECOME OBSCURED. DO NOT DEPEND ON THE RED INDICATOR TO DETERMINE THE UNLOADED CONDITION OF THE PISTOL.

9.6 MAGAZINE

The FN 509 has a standard magazine capacity of 17 rounds and is equipped with witness holes along the back of the magazine to allow for the estimation of rounds remaining in the magazine.

Larger capacity FN 509 magazines will function in FN 509 pistols capable of accepting smaller capacity magazines of the same caliber. The FN 509 magazine will function in older FNS designs but the base plate will not align properly with the frame. FNS magazines can function in the FN 509 if the base plates are replaced.

FN 509 magazines not specifically covered in this manual should be covered by an addendum included with this manual or with the magazine. If the magazine that you have is not covered in this manual or by an addendum, information can be found on the FN website or by contacting FN customer service.

NOTE: Some jurisdictions limit the magazine capacity. All FN pistols intended for sale in those jurisdictions will be shipped with magazines not exceeding the specified number of rounds in compliance with local or state law. Verify the capacity of your magazine before loading it in your pistol to avoid violating local laws in these jurisdictions.

9.7 ACCESSORY MOUNTING RAIL

The FN 509 is equipped with a reinforced accessory mounting rail in front of the trigger guard and is compatible with a wide variety of accessories (Figure 34).

FIGURE 34

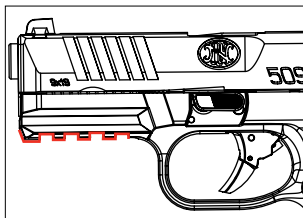

Accessory rail.

9.8 THREADED BARREL (APPLICABLE ONLY TO PISTOLS WITH THREADED BARRELS)

Some FN 509 pistols may be equipped with a threaded barrel that allows for the attachment of a suppressor or other muzzle device. The threading is $\frac{1}{2}$ " -28 and comes with a thread protector that should be installed if a suppressor or muzzle device is not installed (Figure 35).

FIGURE 35

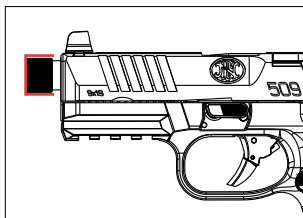

Threaded Barrel with protector.

The FN 509 should only be used with suppressors intended for use with the cartridge for which it is chambered.

Ensure the suppressor is in good condition and is mounted squarely and securely to the barrel.

Muzzle devices such as Compensators can be installed on the threaded barrel. Make sure the hole through the device is larger than the bore diameter and is aligned with the bore.

Note: The FN 509 has been tested to ensure safe operation. The reliability of the pistol may be affected by the installation of a suppressor or muzzle device.

9.9 INTERCHANGEABLE BACKSTRAPS

The FN 509 has been designed to use interchangeable backstraps that allow the pistol to be adapted to fit your hand better (Figure 36). Backstraps provided vary by model.

FIGURE 36

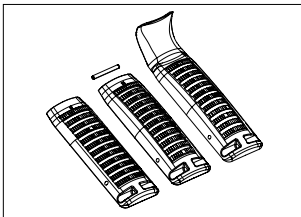

Interchangeable backstraps.

9.10 FN OPTICS MOUNTING SYSTEM (APPLICABLE ONLY TO PISTOLS WITH FN OPTICS MOUNTING SYSTEM)

The FN optics mounting system (Figure 37) allows for the mounting of a variety of optical sights to the slide of the FN 509 without modification to the slide. When an optical sight is not installed a slide cap is installed in its place. Some slide caps include sight protectors that prevent damage or unintentional movement of the rear sight and can be used for the one handed manipulation of the slide.

FIGURE 37

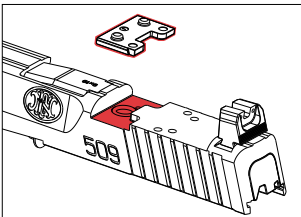

FN optics mounting system.

10. SIGHT ALIGNMENT

NOTE: The sight alignment described is for the standard sights provided with the FN 509 pistol. Alternate sight options may have different sight alignment requirements. Please refer to any special instructions provided with your alternate sights.

The sights of the FN 509 should be aligned with the top of the front sight even with the top of the rear sight and an equal gap between the rear sight and the sides of the front sight. The point of impact will be at the top of the front sight when the sights are properly aligned.

The dots provided on the sights are intended as an aid in low light conditions and provide a less precise but faster sight alignment.

If installing and using an optical sight, the optic must be zeroed for accurate targeting.

NOTE: Optical sight zeroing should be confirmed each time the optical sight is removed. See the sight manufacturer's instructions regarding zeroing of your optical sight. Initial alignment can be performed by aligning the optical reticle with the top of the front sight when the front and rear sights are aligned.

11. DISASSEMBLING AND REASSEMBLING THE PISTOL

11.1 FIELD STRIP (DISASSEMBLY FOR NORMAL MAINTENANCE)

It is very important to become familiar with the disassembly procedure of your pistol. Disassembly to field strip level is required for proper cleaning and lubrication, which ensure reliable operation of the pistol.

1. Completely unload the pistol as described in Section 6.3 and remove the magazine. Inspect the chamber and the magazine well to verify that the pistol is completely unloaded (Figure 38).
2. Retract the slide and lock it in its rearward position using the slide stop (Figure 39).

FIGURE 38

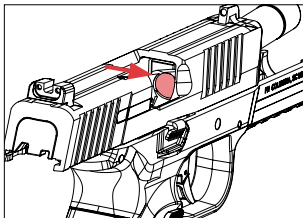

Empty chamber.

3. Remove the thread protector or muzzle device if the pistol is equipped with a threaded barrel (Figure 40).
4. Rotate the takedown lever approximately 100 deg. clockwise (Figure 41).
5. While holding the slide with one hand, release the slide from the slide stop and ease it forward (Figure 42).

FIGURE 41

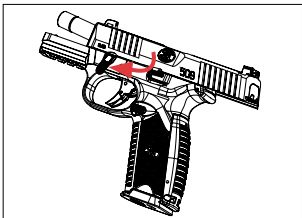

Takedown lever rotated.

FIGURE 39

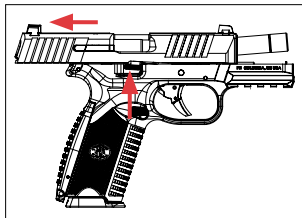

Lock slide open.

FIGURE 40

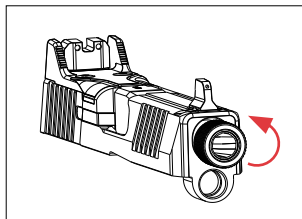

Rotate thread protector counter clockwise for removal.

FIGURE 42

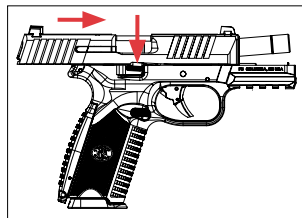

Release slide.

▲WARNING

THE PISTOL MUST BE COMPLETELY UNLOADED TO PERFORM STEP 5. FAILURE TO FOLLOW THIS WARNING COULD RESULT IN SERIOUS INJURY OR DEATH.

5. While keeping the rear of the slide and rear of the frame in alignment, point the muzzle in a safe direction and press the trigger to release the striker. The slide will move forward slightly when released (Figure 43).
6. After releasing the striker, you can remove the slide by pulling the slide forward and away from the frame. If the striker is inadvertently recocked, return to Step 5 (Figure 44).

FIGURE 43

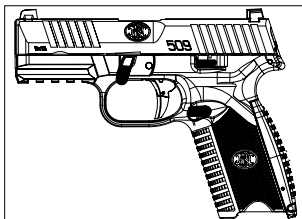

Takedown alignment.

FIGURE 44

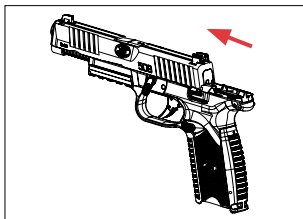

Remove slide.

FIGURE 45

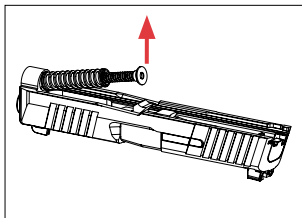

Remove recoil spring.

FIGURE 46

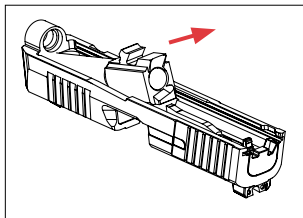

Remove barrel.

7. Hold the slide upside down, grasp the small spring of the recoil spring assembly then lift the recoil spring assembly up and out of the slide (Figure 45).
8. Remove the thread protector or muzzle device if the pistol is equipped with a threaded barrel
9. Grasp the barrel by its lug, lift it up and around the extractor and slide the barrel rearward out of the slide (Figure 46).

This level of disassembly is sufficient to perform a thorough cleaning. Disassembly beyond the instructions provided in this manual should only be carried out by a qualified armorer.

11.2 REASSEMBLY FROM THE FIELD STRIPPED CONDITION

1. Install the barrel into the slide by grasping the lug of the barrel and sliding the muzzle of the barrel through the barrel hole in the slide from the inside. Allow the barrel to drop down into the slide and slide the barrel back to the breach face until the barrel drops into the locked position (Figure 47).
2. Install the thread protector or muzzle device if the pistol is equipped with a threaded barrel (Figure 48)

FIGURE 47

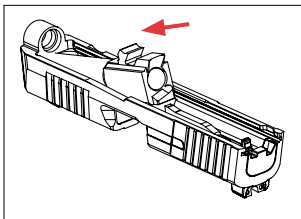

Install barrel.

FIGURE 48

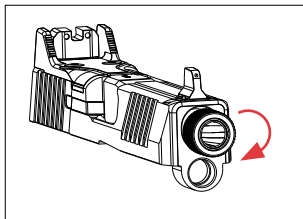

Rotate thread protector clockwise to install.

3. Place the large end of the recoil spring assembly against the recess in the front of the slide. Compress the recoil spring assembly and slide the back of the recoil spring guide onto the recess until centered on the front of the barrel lug (Figure 49).
4. Guide the slide and barrel assembly onto the frame and pull the slide to its rearmost position and lock the slide to the rear using the slide stop (Figure 50).
5. Rotate the takedown lever upward locking the frame and slide together (Figure 51).

FIGURE 49

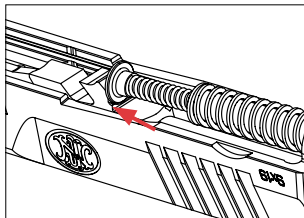

Align recoil spring.

FIGURE 50

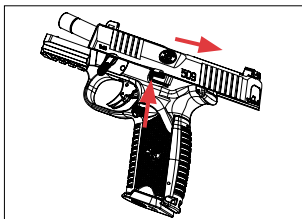

Install slide.

FIGURE 51

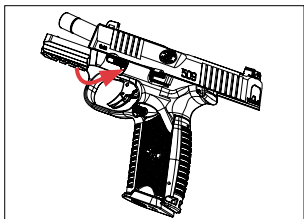

Rotate takedown lever.

6. Release the slide and allow it to travel forward. Test the functions of the pistol to ensure the slide stop, trigger, magazine release and manual safety, if provided, are functioning correctly (Figure 52).

The pistol is now fully reassembled and is ready to be loaded and fired.

FIGURE 52

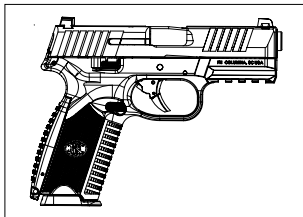

Assembled pistol.

11.3 BACKSTRAP REMOVAL

1. Using a small 5/64" roll pin punch, push out the backstrap retaining pin (Figure 53).

FIGURE 53

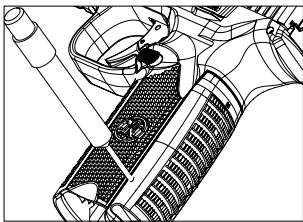

Backstrap pin removal.

FIGURE 54

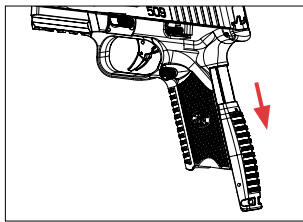

Backstrap removal.

2. Slide the backstrap off the frame (Figure 54).

11.3.1 BACKSTRAP INSTALLATION

1. Slide the backstrap up the dovetail onto the rear of the frame (Figure 55).
2. Press the backstrap into position closing the gap between the top of the backstrap and grip. Ensure the retaining pin hole in the backstrap is aligned with the slot in the dovetail in the frame (Figure 56).

FIGURE 55

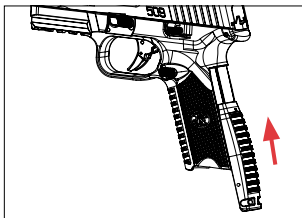

Backstrap installation.

FIGURE 56

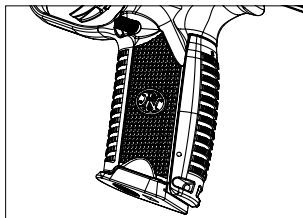

Seated backstrap.

3. Using the back of a punch or a hard surface push the retaining pin into the backstrap. Use the small roll pin punch to center the pin in the backstrap (Figure 57).

FIGURE 57

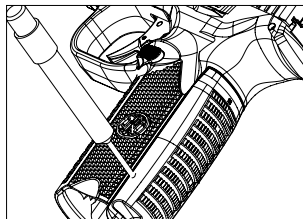

Backstrap pin installation.

11.4 MAGAZINE DISASSEMBLY

CAUTION: THE MAGAZINE SPRING IS UNDER TENSION. WEAR EYE PROTECTION AND KEEP THE BOTTOM OF THE MAGAZINE POINTED IN A SAFE DIRECTION.

1. Depress the floor plate catch through the hole in the bottom of the magazine floor plate. Slide the floor plate forward and off the magazine body. Capture the magazine spring and floor plate catch with your hand as the base plate is removed (Figure 58-59).

FIGURE 58

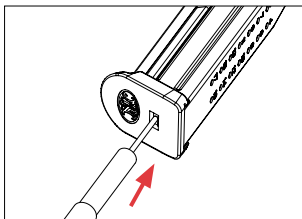

Depress floor plate catch.

FIGURE 59

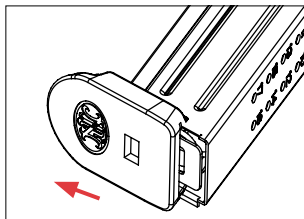

Slide base plate forward.

2. Remove the floor plate catch, magazine spring and follower from the magazine body (Figure 60).

FIGURE 60

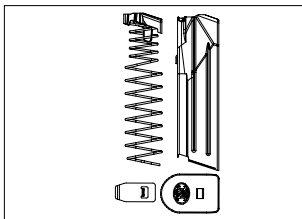

Magazine components.

11.4.1 MAGAZINE REASSEMBLY

1. If removed, assemble the follower on to the magazine spring.
2. Insert the magazine spring and follower into the magazine body with the angle of the follower matched to the angle of the top of the magazine (Figure 61).
3. Using the floor plate catch with the tab protruding down (away from the magazine spring) compress the magazine spring into the magazine body until the spring and floor plate catch are inside of the magazine body (Figure 62).
4. Slide the floor plate onto the magazine body until it is seated against the front of the magazine body (Figure 63).

FIGURE 61

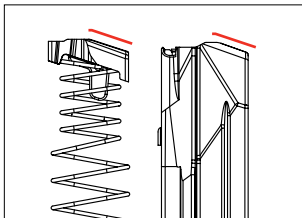

Magazine assembly.

FIGURE 62

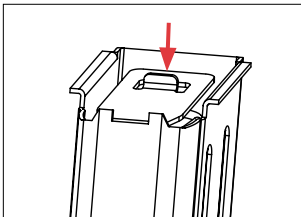

Install floor plate catch.

FIGURE 63

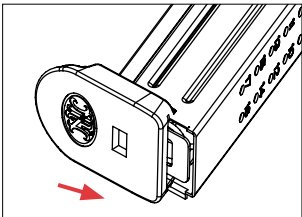

Install floor plate.

5. Ensure that the retaining tab of the floor plate catch protrudes into the magazine floor plate and prevents it from sliding off the magazine. If the floor plate catch does not align, tap the magazine against your hand to move the floor plate catch into location (Figure 64).

FIGURE 64

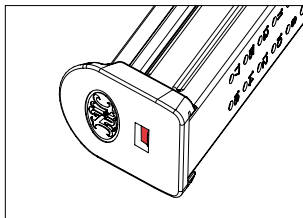

Confirm floor plate installation.

NOTE: Disassembly beyond the instructions provided is not necessary or recommended. Further disassembly should only be performed by FN authorized personnel.

11.5 FN OPTICS MOUNTING SYSTEM (APPLICABLE ONLY TO PISTOLS WITH FN OPTICS MOUNTING SYSTEM)

The FN Optics Mounting System allows for the installation of many available pistol compatible optical sights as well as slide caps to cover the mounting surface if an optical sight is not installed.

The FN Optics Mounting System consists of a cut in the top of the slide, MRD plate, o-ring and screws.

FIGURE 65

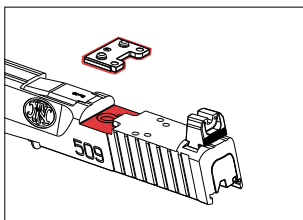

FN Optics mounting System.

To install a different optic or slide cap:

1. Loosen and remove the two screws holding the optic or slide cap to the slide of the pistol by turning the screws counter clock-wise (Figure 66).
2. Remove the optic or slide cap, MRD plate and o-ring (Figure 67 & 68).

FIGURE 66

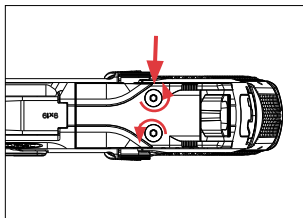

FIGURE 67

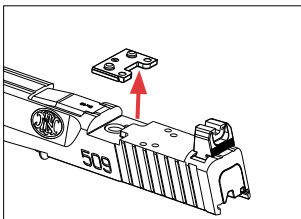
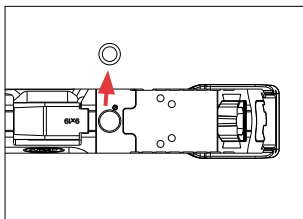

FIGURE 68



3. Inspect and clean the mounting surface on the top of the slide.
4. Select the appropriate MRD plate and screws to match the optic to be installed. Note: A table with MRD plate information can be found later in this section.
5. Remove all lubrication from the mounting screws and the mounting screw holes that will be used to install the selected optic or slide cap.
6. Place the o-ring in the recess in the MRD plate cut in the top of the slide (Figure 69.).

7. Place the MRD plate in the MRD plate cut, sandwiching the o-ring between the slide and plate (Figure 70).

FIGURE 69

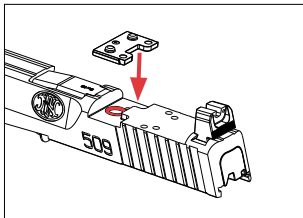
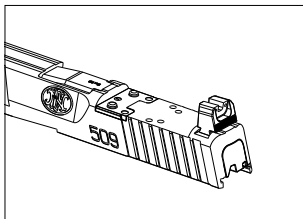

FIGURE 70



8. Set the optic or slide cap on top of the slide and MRD Plate. If your optic requires an MRD insert to be installed under the sight, it should be installed at this time (Figure 71 & 72).
9. Start both mounting screws and tighten them down clock-wise with finger pressure with the provided T10 Torx wrench.

FIGURE 71

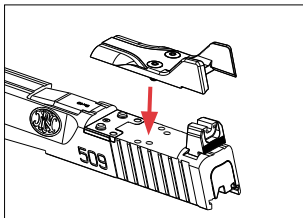
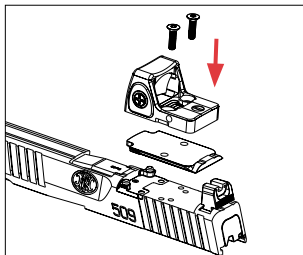

FIGURE 72



NOTE: Do not use threadlocker. The fastening system used on the FN Optics Mounting System is self-locking and does not require threadlocker to remain tight when in use. Use of a thread locker may make it difficult or impossible to remove the optic or slide cap without damage to the components.

Many optics will allow for use of the existing iron sights. If the optic that you have chosen allows this functionality, the optic can be adjusted to match the point of impact of the iron sights closely by adjusting the aiming point of the optical sight to coincide with the aligned iron sights.

Slide Cap/Sight	MRD Plate	MRD Insert	Screw set
Slide cap	① - 501	N/A	515
Leupold DeltaPoint Pro	① - 501	505	510
Trijicon RMR	② - 502	506	511
Docter Optic	③ - 503	507	512
Vortex Venom	③ - 503	507	512
Vortex Viper	③ - 503	507	513
Vortex Razor	④ - 504	N/A	514
C-More STS2	④ - 504	N/A	514
Burris	③ - 503	507	512

11.6 SUPPRESSOR AND MUZZLE DEVICE INSTALLATION AND USE (APPLICABLE ONLY TO PISTOLS WITH THREADED BARRELS)

FN 509 pistols with threaded barrels are threaded with ½" - 28 right-hand threads and allow the pistol to be equipped with a suppressor or muzzle device. It is imperative to use a suppressor or muzzle device that is appropriate for use to ensure safe functioning.

⚠ WARNING

THE SUPPRESSOR OR MUZZLE DEVICE MUST HAVE A BORE LARGE ENOUGH TO ACCOMMODATE THE CARTRIDGE TO BE FIRED. A SUPPRESSOR OR MUZZLE DEVICE INTENDED FOR USE WITH A CALIBER SMALLER THAN THE CARTRIDGE THAT THE PISTOL IS CHAMBERED FOR IS DANGEROUS TO USE

AND USE WILL RESULT IN DAMAGE TO THE SUPPRESSOR OR MUZZLE DEVICE AND PISTOL, AND COULD RESULT IN INJURY TO THE SHOOTER OR THOSE NEARBY. THE BORE OF THE SUPPRESSOR OR MUZZLE DEVICE MUST ALIGN WITH THE BORE OF THE BARREL. IF THE PISTOL IS FIRED WITH THE SUPPRESSOR OR MUZZLE DEVICE MISALIGNED THE SUPPRESSOR OR MUZZLE DEVICE WILL BE DAMAGED, THE PISTOL MAY ALSO BE DAMAGED AND COULD RESULT IN INJURY TO THE SHOOTER OR THOSE NEARBY.

Select a suppressor or muzzle device that is rated for use with the caliber of your FN 509; the caliber is marked on the back of the barrel and is visible through the ejection port. Use only suppressors or muzzle devices compatible with the thread pattern on the FN 509.

To install a suppressor or muzzle device on your FN 509:

1. Remove the thread protector from the muzzle of the pistol. The thread protector is attached with right-hand threads and should be removable without tools. (Figure 73).
2. Choose your suppressor or muzzle device and follow the manufacturer's instructions to ensure the suppressor is in good working condition and is appropriate for use on your FN 509. The suppressor or muzzle device must be equipped with $\frac{1}{2}$ " - 28 right-hand threads to be properly installed.

FIGURE 73

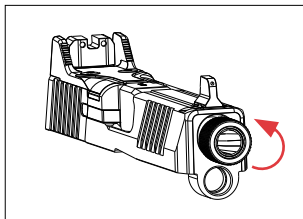

3. Thread the suppressor or muzzle device on to the barrel and tighten it following the manufacturers recommendations. Check to ensure that the bore of the suppressor aligns with the bore of the barrel and nothing blocks the path of the bullet (Figure 74).

FIGURE 74

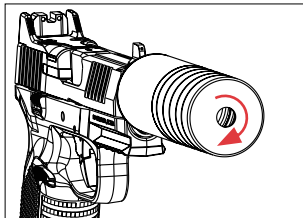

The pistol can now be fired with the suppressor or muzzle device installed. If a suppressor is attached to the barrel without a Nielsen device, the pistol can be safely fired but will not cycle properly.

NOTICE: FN is not responsible for damage to a suppressor or muzzle device when used on the FN 509 or for damage caused to the pistol due to the installation of a suppressor or muzzle device.

⚠ WARNING

ALWAYS ENSURE THAT A SUPPRESSOR IS THREADED ON TIGHTLY WHEN THE PISTOL IS FIRED TO AVOID DAMAGE TO THE SUPPRESSOR OR PISTOL.

11.7 REMOVING THE MAGAZINE RELEASE

NOTE: The magazine release should not be removed for normal cleaning and maintenance.

NOTE: The frame assembly does not need to be disassembled to remove the magazine release.

1. Press up on the magazine catch spring through the magazine well using a punch or similar tool on the leg of the spring that protrudes toward the magazine well. Pushing the leg of the spring in toward the frame and under the body of the magazine release.

2. Pull the magazine catch spring up until it is above the magazine release, using a punch to catch the top loop of the spring.

NOTE: The spring does not need to be removed from the frame to remove the magazine release, removing the spring makes reassembly more difficult.

3. Slide the magazine release out of the grip.

11.7.1 INSTALLING THE MAGAZINE RELEASE

1. If the magazine catch spring has been removed from the frame, use your index finger to slide the spring into the slot starting at the top front of the magazine well. The hooked ends of the magazine catch spring should face the interior of the magazine well. Use your finger to start one side of the magazine catch spring into the slot and compress the spring with your finger to start the other side of the spring into the slot.
2. Slide the magazine release into the grip with the beveled surface below the locking surface facing down and the slot in the magazine release aligned with the magazine release spring slot.
3. Press the magazine catch spring down and through the magazine release until the hooked end is even with the top surface of the magazine release.
4. Actuate the magazine release to ensure it operates freely and the magazine is released when it is pressed.

12. CLEANING AND LUBRICATION

▲WARNING

BEFORE PERFORMING CLEANING PROCEDURES, MAKE SURE THE PISTOL IS COMPLETELY UNLOADED (SECTION 6.3). ALWAYS KEEP THE MUZZLE POINTED IN A SAFE DIRECTION. FAILURE TO FOLLOW THESE WARNINGS COULD RESULT IN SERIOUS INJURY OR DEATH.

WEAR EYE PROTECTION WHEN DISASSEMBLING, ASSEMBLING AND CLEANING YOUR PISTOL AND MAGAZINE TO PREVENT SPRING-LOADED PARTS, SOLVENTS OR OTHER AGENTS FROM CONTACTING YOUR EYES, RESULTING IN INJURY.

KEEP ALL AMMUNITION AWAY FROM THE CLEANING AREA. NEVER TEST THE MECHANICAL FUNCTION OF YOUR PISTOL WITH LIVE AMMUNITION. FAILURE TO FOLLOW THESE WARNINGS COULD RESULT IN SERIOUS INJURY OR DEATH.

NOTE: Never soak your firearm in solvents or lubricants. This could cause damage to the pistol or cause the pistol to malfunction.

NOTE: Do not use too much lubricant. Using too much lubricant can interfere with the function of the pistol.

Your pistol will function better and more reliably over a longer period of time if it is properly maintained and cleaned.

The frequency at which the pistol should be cleaned and lubricated depends on external factors. The weather and shooting conditions that expose your pistol to dirt, moisture, salt or sand can affect the function of your firearm. Excessively dirty ammunition or use with a suppressor may also require more frequent cleaning. Clean and lubricate your pistol after every use or if exposed to conditions that could adversely affect the finish or function of your pistol. Application of a light coat of preservative oil to the metal surfaces of the pistol will increase the corrosion resistant properties of the applied finish. In the case of intensive shooting, the pistol should be cleaned every 500 rounds. A minimum cleaning includes disassembly to the field strip level, wiping away accumulated fouling and lubricating key parts. Regular maintenance also includes cleaning the barrel.

A gun brought out of prolonged storage should also be cleaned before shooting. Accumulated moisture and dirt, or solidified grease and oil, can prevent the gun from operating properly.

12.1 CLEANING AND LUBRICATION BEFORE FIRING

CAUTION: WEAR EYE PROTECTION AND PRACTICE SAFETY MEASURES APPROPRIATE FOR THE CHEMICALS BEING USED WHEN WORKING WITH SOLVENTS TO AVOID SERIOUS INJURY. MANY SOLVENTS ARE HIGHLY FLAMMABLE.

1. Completely unload the pistol as described in Section 6.3.
2. Disassemble the pistol as described in Section 11.1.
3. Using a cleaning rod and patches, bore snake or similar cleaning tool, remove any lubricant or debris from the inside of the barrel by inserting the cleaning rod or bore snake from the breach end of the barrel and pushing it through until the barrel appears clean when looked through.

NOTE: Be careful not to scratch or damage the muzzle as this can affect accuracy. It is recommended to only clean the barrel from the chamber end.

4. Before initial use remove the storage preservative from the outside of the barrel, slide, recoil spring assembly and the frame.
5. Lightly lubricate the outside of the barrel with lightweight gun oil.
6. Assemble the slide, barrel and recoil spring assembly as described in Section 11.2.
7. Lightly lubricate all of the sliding surfaces with lightweight gun oil (Figure 75).
8. Reassemble the pistol as described in Section 11.2.

FIGURE 75

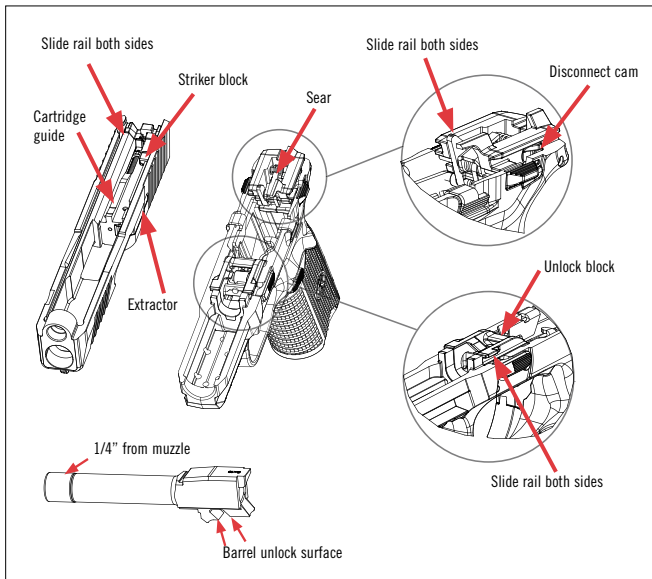

Lubrication Points.

12.2 CLEANING AND LUBRICATION AFTER FIRING

CAUTION: WEAR EYE PROTECTION AND PRACTICE SAFETY MEASURES APPROPRIATE FOR THE CHEMICALS BEING USED WHEN WORKING WITH SOLVENTS TO AVOID SERIOUS INJURY. MANY SOLVENTS ARE HIGHLY FLAMMABLE.

1. Completely unload the pistol as described in Section 6.3.
2. Disassemble the pistol as described in Section 11.1.
3. With a cleaning brush or a spray, apply solvent inside the barrel and allow the product to penetrate for a few minutes.

NOTE: Follow the instructions provided with the cleaning solvent if it differs from these instructions. Keep solvents away from the polymer components of this pistol.

4. With a correctly sized cleaning rod, brush, jag and patches, remove the solvent and fouling from the inside of the barrel until patches come out clean.

NOTE: Be careful not to scratch or damage the muzzle as this can affect accuracy. It is recommended to only clean the barrel from the chamber end.

5. When the barrel is clean, use a cleaning rod and patch moistened with preservative oil and wipe the inside of the barrel to protect the barrel until the next use.

NOTE: Always remove the oil from the inside of the barrel before shooting as detailed in Section 12.1.

6. Use a brush and solvent or multipurpose gun-cleaning lubricant to remove carbon deposits and other fouling from the slide, barrel, extractor and other areas that accumulate residue from firing.
7. Use a soft cloth or a rag, and multipurpose lubricant if necessary, to remove debris from the magazine well of the frame.

8. Clean all of the parts of the pistol and magazine that are accessible using a soft cloth or rag dampened with a lightweight gun oil or multipurpose lubricant and nylon brush, if needed, to remove the fouling and debris accumulated during firing.
9. Check the disassembled parts of the pistol for signs of wear and/or damage. In case of doubt about the condition of a part, consult an FN authorized individual.
10. Using a soft cloth moistened with lightweight gun oil, lightly apply the lubricant to all the external surfaces of the metal parts to increase corrosion resistance.
11. Apply a drop of lubricant to the locations shown in Figure 61 on page 49.
12. Reassemble the pistol as described in Section 12.
13. Clean the outside of the pistol in order to remove dirt, fingerprints and excess lubricant.

NOTE: If the pistol requires additional cleaning due to exposure to adverse conditions, it should be serviced by an FN authorized individual or service center.

13. SCHEMATIC AND PARTS LIST

13.1 FN 509 STANDARD MODEL

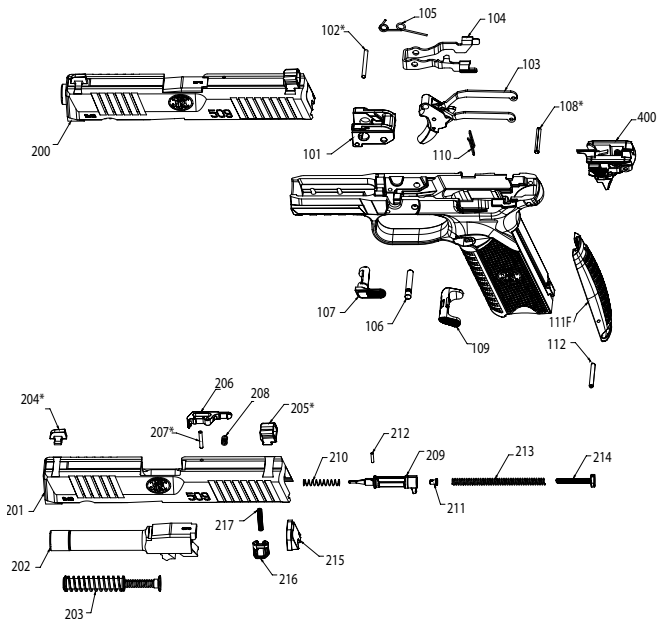

* Replacement recommended after removal

** Non-manual safety model only

*** Manual safety model only

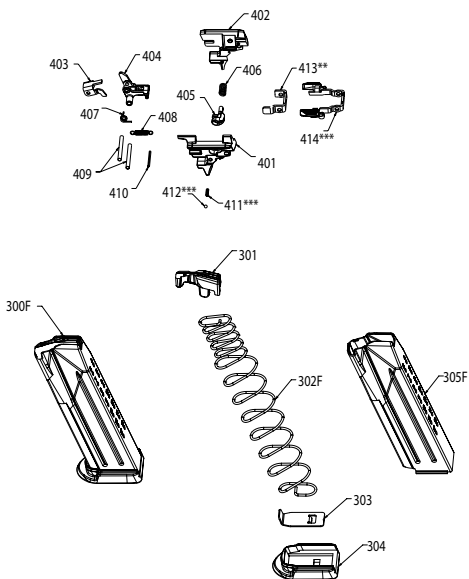

FN 509 STANDARD MODEL PART LIST

Number	Description	Number	Description
101	Unlock Block	206	Extractor
102 *	Pin, Unlock Block Retaining	207-A*	Pin, Extractor
103	Trigger Assembly	208	Spring, Extractor
104	Lever, Slide Stop	209	Striker
105	Spring, Slide Stop	210	Spring, Striker Return
106	Pin, Trigger	211	Striker Spring Stop
107	Lever, Take Down	212	Pin, Striker Spring Stop
108 *	Pin, Fire Control	213	Spring, Striker
109	Release, Magazine	214	Guide, Striker Spring
110	Spring, Magazine Catch	215	Slide End Cap
111F-A	Backstrap, Small, Black	216	Block, Striker
111F-B	Backstrap, Medium, Black	217	Spring, Block
111F-C	Backstrap, Large, Black	300F-A	Magazine Assembly, 17 Rd, Black
112	Pin, Backstrap Retaining	300F-B	Magazine Assembly, 10 Rd, Black
200-A	Slide Assembly, FN 509, Black, DS	301	Follower, 9mm, Orange
200-B	Slide Assembly, FN 509, Black, NS	302F	Spring, Magazine
201	Slide, FN 509, 9mm, Black	303	Catch, Magazine Floorplate
202	Barrel, 4.02"	304	Floorplate, Magazine, Black
203	Recoil Spring Assembly	305F-A	Tube, 509F Magazine, 17 Rd
204-A*	Sight, Front, Day	305F-B	Tube, 509F Magazine, 10 Rd
204-B*	Sight, Front, Night	400-A	Fire Control Assembly, 509, NMS
205-A*	Sight, Rear, Day		
205-B*	Sight, Rear, Night		

Number	Description
400-B	Fire Control Assembly, 509, MS
401	Housing, Left
402	Housing, Right
403	Sear
404	Carrier, Sear
405	Cam, Disconnect
406	Spring, Disconnect
407	Spring, Sear
408	Spring, Carrier
409	Pin, Carrier
410	Pin, Carrier Spring
411***	Spring, Detent
412***	Bearing, Ball
413**	Clip, Retaining
414***	Overmold, Manual Safety

13.2 FN 509 SERIES MRD SLIDE ASSEMBLIES PARTS FN 509 STANDARD MRD MODELS

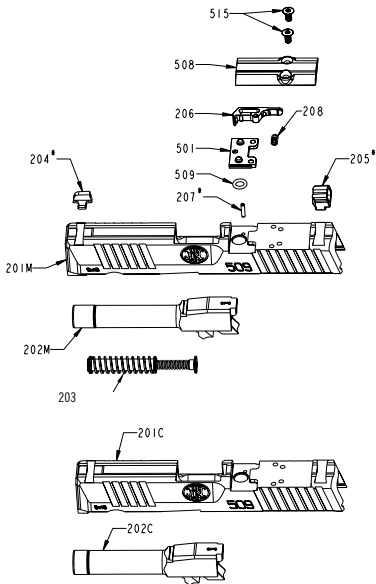

* Replacement recommended after removal

FN 509 TACTICAL MODEL

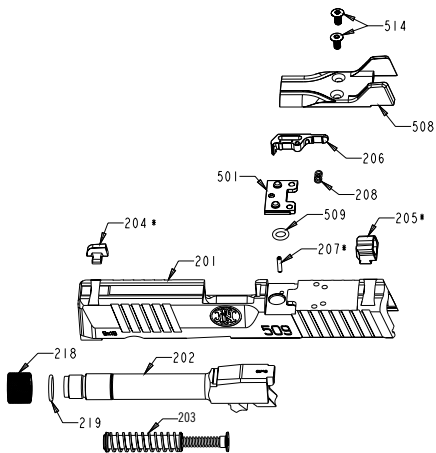

* Replacement recommended after removal

FN 509 SERIES MRD SLIDE ASSEMBLIES PARTS LIST

Number	Description	Number	Description
201	Slide, FN 509T, Gaurded	502	MRD Plate, RMR
202	Barrel, 4.5", Threaded	503	MRD Plate, Docter
203	Recoil Spring Assembly	504	MRD Plate, C-More Sts
204-C*	Sight, Front, Tall, Night	505	MRD Insert, DP Pro
204-D*	Sight, Front, Tall, No Dots	506	MRD Insert, RMR
205-C*	Sight, Rear, Tall, Night	507	MRD Insert, Docter
205-D*	Sight, Rear, Tall, No Dots	508	MRD Cap, FN 509, Guarded
206	Extractor	509	O-Ring, FN 509 MRD
207-B*	Pin, Extractor	510	Screw, Countersunk, .625
208	Spring, Extractor	511	Screw, Countersunk, .530
209	Striker	512	Screw, Countersunk, .375
210	Spring, Striker Return	513	Screw, Counterbore, .313
211	Striker Spring Stop	514	Screw, Counterbore, .375
212	Pin, Striker Spring Stop	515	Screw, Countersunk, .313
213	Spring, Striker		
214	Guide, Striker Spring		
215	Slide End Cap		
216	Block, Striker		
217	Spring, Block		
218	Cap, Threaded Barrel		
219	O-Ring, Thread Cap		
501	MRD Plate, DP Pro		

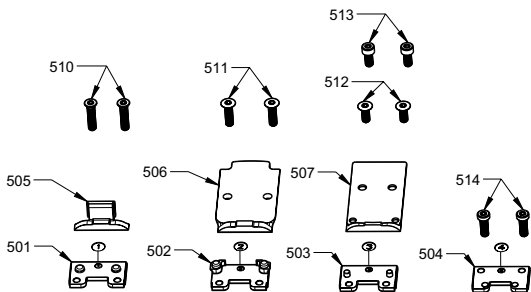

NOTE: MRD Plates identification markings. Example 501 is marked 1.

How to identify Screw types

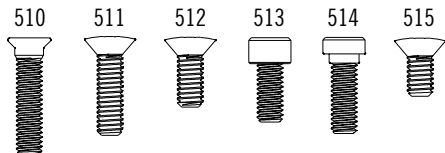

NOTE: Optional MRD Mounting hardware available

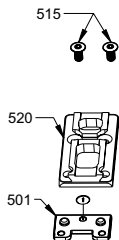

13.3 FN 509 SERIES FRAME & MAGAZINE ASSEMBLY PARTS

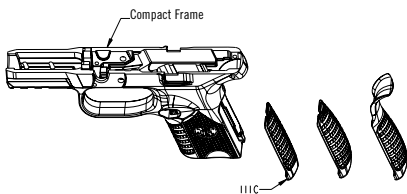
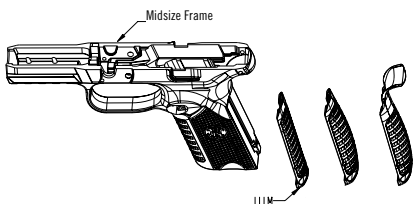
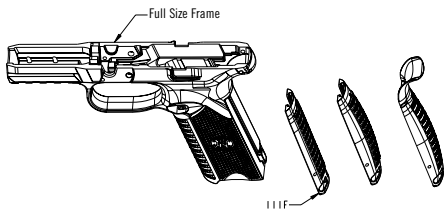

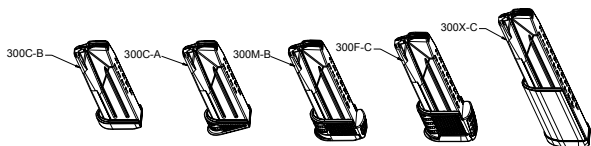
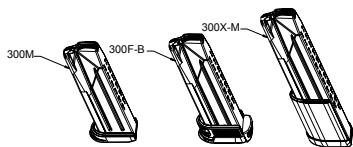
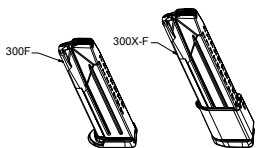

FN 509 SERIES FRAME & MAGAZINE ASSEMBLY PARTS LIST

Number	Description
Full Size Frame	
111F-A	Backstrap, Small, Black
111F-B	Backstrap, Medium, Black
111F-C	Backstrap, Large, Black
300F	509 Magazine Assembly, 17 Rd, Black
300X-F	509 Magazine Assembly, 24 Rd, Black

Number	Description
Midsize Frame	
111M-A	Backstrap, Small, Black
111M-B	Backstrap, Medium, Black
111M-C	Backstrap, Large, Black
300M	509M Magazine Assembly, 15 Rd, Black
300F-B	509M Magazine Assembly, 17 Rd, Black
300X-M	509M Magazine Assembly, 24 Rd, Black

Number	Description
Compact Frame	
111C-A	Backstrap, Small, Black
111C-B	Backstrap, Medium, Black
111C-C	Backstrap, Large, Black
300C-B	509C Magazine Assembly, 12 Rd Flat, Black
300C-A	509C Magazine Assembly, 12 Rd Pinky, Black
300M-B	509C Magazine Assembly, 15 Rd, Black
300F-C	509C Magazine Assembly, 17 Rd, Black
300X-C	509C Magazine Assembly, 24 Rd, Black

14. WARRANTY, SERVICE AND TECHNICAL QUESTIONS

Returning your firearm for service

When returning your firearm for service, be sure to follow the guidelines below:

NOTICE: ALL FFL HOLDERS, IN ORDER TO AVOID UNNECESSARY RETURN SHIPPING DELAYS PLEASE SUBMIT AN FFL WHEN A FIREARM IS SENT IN FOR SERVICE.

1. Complete the online sign-up form and register to request service via FN's website, www.fnamerica.com.
2. Be sure your gun is completely unloaded.
3. Package it securely in a double-packed cardboard container.
4. Include a copy of your service request confirmation with your firearm that clearly describes the nature of your repair concerns or service desired. If the service form is NOT included with your firearm your service will be delayed.
5. Include a day time phone number where you can be reached.
6. Never return ammunition with your firearm. It is against postal and most commercial regulations.
7. Remove all accessories. FN America is not responsible for lost or damaged aftermarket accessories.

IMPORTANT: FN AMERICA IS NOT RESPONSIBLE FOR DAMAGE INCURRED DURING SHIPPING.

IMPORTANT: Any addition to your FN firearm of aftermarket accessories (such as suppressors, triggers, muzzle devices, stocks, etc.) is considered a modification of your firearm from its original configuration, which may void your warranty. We are unable to adapt each firearm for every variable effect that might occur when you install a third-party manufacturer's accessory on an FN firearm. Therefore, FN disclaims all responsibility and liability for any damage caused to you and/or your firearm as a result of aftermarket accessory use. If an aftermarket accessory causes damage to you and/or your firearm, please address your concerns with the accessory manufacturer.

IF YOU DO NOT UNDERSTAND THE INSTRUCTIONS FOR OPERATING YOUR FN FIREARM, IT IS YOUR RESPONSIBILITY TO CONTACT FN CUSTOMER SERVICE AT 1-800-635-1321 BEFORE USING THE FIREARM.

This owner's manual should always accompany this firearm and be transferred with it upon any change of ownership.

If you have any further questions, please call Customer Service at 1-800-635-1321.

16. TECHNICAL SPECIFICATIONS

	FN 509	FN 509 TACTICAL	FN 509 MIDSIZE
Caliber	9mm Parabellum	9mm Parabellum	9mm Parabellum
Length (in.)	7.4	7.9	7.4
Height (in.)	5.56	5.75	5.2
Width (in.)	1.35	1.35	1.35
Sight Radius (in.)	5.8	5.8	5.8
Barrel Length (in.)	4	4.5	4
Twist Rate (in.)	1:10 RH	1:10 RH	1:10 RH
Weight w/ Empty Magazine (oz.)	26.9	27.9	26.5
Magazine Capacity			
Standard model	17	24 & 17	15
Optional	10	10	10
Trigger Pull (lbs.)	5.5 - 7.7	5.5 - 7.7	5.5 - 7.7

All specifications subject to change without notice.

	FN 509 MIDSIZE MRD	FN 509 COMPACT MRD
Caliber	9mm Parabellum	9mm Parabellum
Length (in.)	7.4	6.75
Height (in.)	5.3	5.2 / 4.8*
Width (in.)	1.35	1.35
Sight Radius (in.)	5.8	5.6
Barrel Length (in.)	4	3.7
Twist Rate (in.)	1:10 RH	1:10 RH
Weight w/ Empty Magazine (oz.)	26.5	26.5
Magazine Capacity		
Standard model	15	12 & 15
Optional	10	10
Trigger Pull (lbs.)	5.5 - 7.7	5.5 - 7.7
		* Optional Flat Magazine

NOTES:

NOTES:



WWW.FNAMERICA.COM