

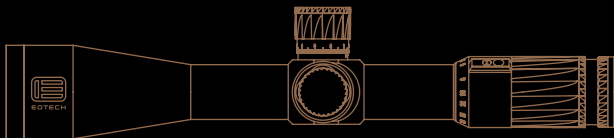

EOTECH®



vudu® 3.5-18x50 FFP

PRECISION RIFLESCOPE

Export of this product is strictly controlled and enforced by the U.S. Department of Commerce, Bureau of Industry and Security, as prescribed in the Export Administration Regulation (EAR), Title 15, Code of Federal Regulations, Parts 730-774. EOTECH LLC does not authorize any of its dealers or distributors to export this commodity without prior, written authorization, and will not provide warranty or post-sales support of unauthorized international exports.

Contents

1 / FEATURES

Anatomy	4
Specifications	5

2 / GET STARTED

Adjustments	6
Magnification Adjustment	
Reticle Focus Adjustment	
Parallax	
Image Focus and Parallax Adjustment	
Illumination Adjustment	
Elevation and Windage Adjustment	
Re-Indexing the Turret Dials	12
EZ Chek Zero Stop	14
Battery Replacement	15
Riflescope Mounting	16
Ring Mounts	
Eye Relief	17
Quick Throw Lever	18
Zeroing Procedure	19
Bore Sighting	
Live Fire Range Sight-In	

3 / MAINTENANCE

Cleaning and Care	20
NoBS Warranty	21
Service and Repair	22
Contact Information	23

Anatomy

At EOTECH, our riflescopes are engineered and constructed to meet the rugged demands of the serious precision shooter. The Vudu 3.5-18x provides a robust 34mm tube, XC™ High-Density glass, and side mounted parallax adjustment. It is loaded with all of the high performance features required to take that precise long-range shot.



Specifications

Magnification	3.5-18x
Focal Plane	First
Tube Diameter	34mm
Objective Diameter	50mm
Illuminated	Yes
Battery Type	CR2032
Overall Length	14.8" (377mm)
Weight	33.6 oz (952g)
Eye Relief	3.5x: 3.58–3.97" (91-101mm) 18x: 3.54–3.97" (90-101mm)
Field-of-View @ 100 yds	3.5x: 29.5 ft (9m) 18x: 5.7 ft (1.7m)

Reticle Specifications	MD1	MD2	H59
Adjustment Graduation per Click	0.1 MRAD	0.25 MOA	0.1 MRAD
Adjustment Graduation per Rotation	10 MRAD	25 MOA	10 MRAD
Total Elevation Travel	29 MRAD	100 MOA	29 MRAD
Total Windage Travel	23 MRAD	80 MOA	23 MRAD

Adjustments

Magnification Adjustment

- The EOTECH Vudu 3.5-18x uses a single construction eyepiece for exceptionally fast and easy adjustments.
- To change the magnification, simply turn the magnification eyepiece to the desired level.



Reticle Focus Adjustment

- The Vudu 3.5-18x riflescope uses an eyepiece focus ring that is designed to quickly adjust the focus of the riflescopes reticle.
- To adjust the reticle focus, look through the riflescope at a solid background color. Rotate the eyepiece focus dial clockwise or counterclockwise until the reticle image is as crisp as possible for the shooter.

PRO TIP: *A solid white wall or clear sky make for good backdrops.*

- Once the focus adjustment is complete, it is not necessary to re-focus every time the riflescope is used. However, it is a good idea to occasionally re-check this adjustment.



Parallax

Parallax is a condition that occurs when a target does not fall on the same optical plane as the reticle within the scope. If the shooter's eye is off-center in the viewing window this can cause an apparent change in the position of the reticle relative to the target.

For optimal performance, properly focus the reticle for your eye, then use the parallax adjustment instructions to place the target image and reticle on the same optical plane.

PRO TIP: *When shooting at long-range, using good form and consistent cheek weld will optimize your body position and help minimize parallax error.*

Image Focus and Parallax Adjustment

The Vudu 3.5-18x riflescope features a side focus adjustment dial that should be used to obtain a precise image focus.

1. Verify that the reticle is properly focused (*refer to page 7*)
2. Adjust the side focus dial until the target image is as clear as possible. The yardage numbers on the dial should be close to the actual distance to the target.
3. If the focus is properly set there should be no apparent reticle shift on the target when moving your head back and forth while looking through the scope. If any shift is observed, adjust the focus dial until the shift is eliminated.

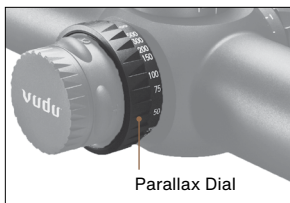

Illumination Adjustment

- The Vudu 3.5-18x riflescope uses an illuminated reticle to assist the shooter in low light conditions. The illumination is controlled by a set of push buttons located on the left side of the riflescope main body. They provide 10 levels of operator controlled brightness settings.
- The illumination is designed to turn-on at the same setting where it was turned off. This allows the shooter to quickly return to a favored brightness setting with just a single button push.
- In addition to the On/Off button, the illumination can also be turned on using the Up/Down buttons. Only the On/Off button will turn the illumination off.
- The Vudu 3.5-18x contains an auto-shutdown feature that will automatically turn the illumination off after approximately 2 hours of inactivity (no button pushes). This preserves battery life and eliminates the chance of accidentally leaving the illumination on.

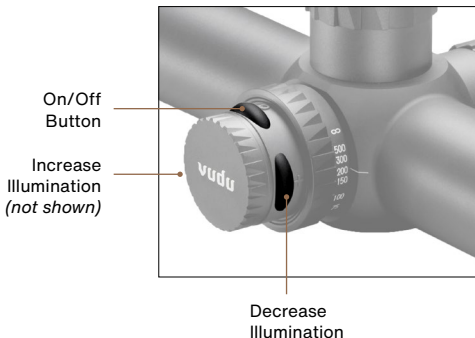

Elevation and Windage Adjustment

The Vudu 3.5-18x riflescope contains precision tool-less adjustable elevation and windage turret dials for zeroing your riflescope. The adjustments contain an audible click with a distinctive tactile feel to assist the shooter in making the proper Point-of-Impact (POI) correction. The turrets are clearly marked with the appropriate correction in either MOA or MRAD depending on your particular model.

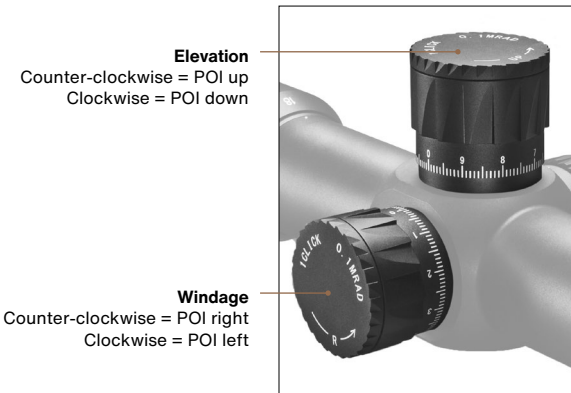

The Vudu 3.5-18x riflescope turrets use clicks calibrated for either milliradian (MRAD) or minutes of angle (MOA) depending on the reticle selection for your particular model.

Each click of the turret will approx. adjust the POI as follows:

Yards	0.1 MRAD =	0.25 MOA =
100	0.36 in / 1cm	0.26 in / 0.66cm
200	0.72 in / 2cm	0.52 in / 1.35cm
400	1.44 in / 4cm	1.04 in / 2.67cm
600	2.16 in / 6cm	1.56 in / 3.96cm

Re-Indexing the Turret Dials

After successfully zeroing your riflescope, the indicator numbers located around the perimeter of the turrets will likely be set on a number other than 0. You can quickly and easily re-index this scale back to 0. Although not necessary, it is recommended that you perform this step as it will allow you quickly return back to your zero at any time without needing to remember the numeric turret location.

To re-index the turret scale back to 0, perform the following steps:

1. Unload and clear your rifle.
2. While holding onto the elevation turret dial to prevent it from turning, use a coin or screwdriver to loosen the turret cap highlighted in the image below.
3. Remove the turret cap.



4. Pulling straight out, remove the turret dial from the riflescope.
5. The turret dial contains an o-ring seal to prevent moisture from entering the turret assembly. After removal, keep the turret dial facing upwards to prevent the o-ring from falling out.
6. Align the '0' marking on the turret dial with the vertical alignment marking on the riflescope body and gently reinsert the dial back onto the turret assembly.
7. Using a coin or screwdriver, tighten the turret cap back onto the dial while holding the dial with your other hand to prevent rotation.
8. Repeat the same procedure on the windage dial.

Your riflescope is now set to '0'. Should you need to make any turret adjustments to correct for distance or wind, you can quickly return back to this original zero setting. This feature also serves as a quick visual aid to verify that your turrets have not been inadvertently moved.

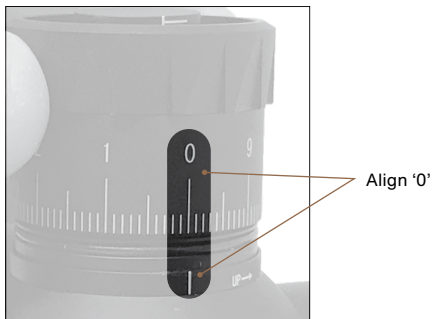

EZ Chek Zero Stop

The Vudu 3.5-18x includes EOTECH's EZ Chek Tactical turrets that allow the user to set their turrets so they will hard stop at their zeroed location.

1. Perform steps 1-6 from the previous section on re-indexing the turret dials.
2. Loosen the three set screws on the EZ Chek ring with a **1.5mm allen wrench**. The ring will now be free to slide up and down the turret assembly.
3. Locate the small machined tab on the underside of the ring and position it to the right of the pin on the turret assembly. If you wish to set your scope so you can go a bit beyond zero, leave a space between the pins of about 1/4 in.
4. Tighten the (3) set screws on the EZ Chek ring.
5. Perform steps 7-8 from the previous section on re-indexing the turret dials.

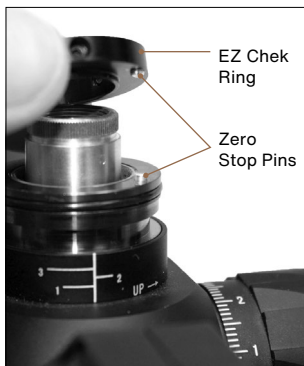

Battery Replacement

- To change the battery, unscrew the outer cap (no tool necessary).
- Remove the battery and replace with a new **CR2032** battery.
- The battery should be inserted with the positive side facing outward.

PRO TIP: *It is recommended to remove the battery during storage. The battery cap is clearly marked with the Vudu logo.*

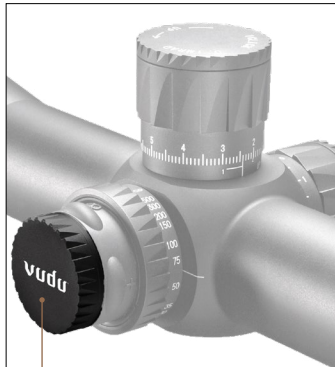

Battery
Cap

Riflescope Mounting

- To obtain the optimal performance from your Vudu riflescope, proper mounting is required.
- Although not overly difficult, if you are unsure of your scope mounting abilities, the use of a qualified gunsmith is recommended.
- Only mount your riflescope on a cleared and empty rifle while always observing safe gun handling.

Ring Mounts

- Following the manufacturer's installation instructions, attach high quality ring mounts to your firearm.
- The Vudu 3.5-18x riflescope requires **34mm rings**.
- Different firearms will require specific ring heights.
- It is best practice to use the lowest rings possible to keep the center line of the riflescope as close to the barrel as possible. If you are unsure, consult the ring mount manufacturer for recommendations.

PRO TIP: *AR-style rifles will typically require a forward cantilevered mount to obtain the proper eye relief.*



Eye Relief

Before fully tightening the ring screws, adjust the position of the riflescope for optimum eye relief. Proper eye relief will make for a more comfortable shooting position and help prevent injury from recoil.

To adjust for eye relief:

- Place the scope as far forward in the mounting rings as possible.
- While holding the rifle in a normal shooting position, slowly move the riflescope towards your eye until you have a full field of view. For the Vudu 3.5-18x, this will be between approximately 3 to 4 inches. Keep the riflescope in this position.
- **Rotate the riflescope so that the elevation dial is at the top.**
- Ensure that reticle is level before fully tightening rings. A reticle that is not level will not track correctly with your elevation and windage inputs. Multiple devices and methods to ensure a level reticle can be found with an internet search. If you are unsure of your ability to do so please seek the assistance of a qualified gunsmith.

PRO TIP: *The use of a leveling tool or set of feeler gauges placed between the mount and the flat bottom of the riflescope can assist in this step.*

- After aligning the reticle, tighten and torque the ring screws down to the manufacturer's recommendation.

Quick Throw Lever

- A quick throw lever is supplied with your Vudu rifle scope.
- It is designed to allow for rapid magnification changes.
- You can install the throw lever by screwing it into the threaded hole on the eye-piece (shown below).
- The lever should be installed finger tight.
- A drop of medium loctite on the threads will help prevent the lever from backing out under recoil.

PRO TIP: *Should you wish to remove the throw lever, store it in a secure place for future use. Replacement parts can be purchased at eotechinc.com.*

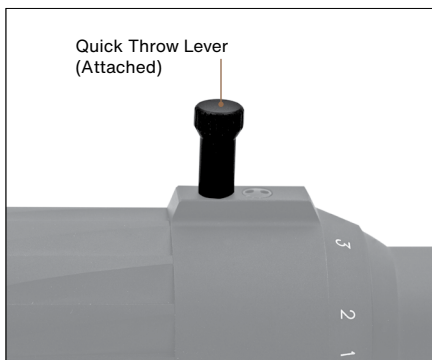

Zeroing Procedure

Bore Sighting

Bore sighting the riflescope saves time and ammunition at the range. This can be done using a laser bore sighter per the manufacturer's instructions or by removing the bolt on a bolt action rifle and visually sighting through the barrel.

To visually bore sight your riflescope:

- Verify that the rifle is clear and unloaded, then remove the rifle's bolt and place the rifle on a stable platform.
- Look through the barrel at a target approx. 100 yards away.
- With the target in the center of the barrel, make elevation and windage adjustments until the reticle crosshair of the riflescope is also centered on the target.
- The riflescope is now bore-sighted. Move on to range sight-in to fine tune your zero.

Live Fire Range Sight-In

- Using the same ammunition that you plan to shoot or hunt with, fire a 3-shot group at your preferred zero distance.
- Keeping the gun barrel steady on your aiming target, adjust your windage and elevation so that the reticle aligns with the approximate center of the 3-shot group.
- Fire another 3-shot group to see if it now groups on the center of the bullseye.
- Repeat this process as necessary to achieve an accurate zero.

After achieving an accurate zero, the windage and elevation dials should be re-indexed (**See *Re-Indexing the Turret Dials*, page 12-13**).

Cleaning and Care

1. The Vudu riflescope lenses are coated with an anti-reflective material. When cleaning the glass surfaces, first blow or brush away any dirt and dust. Fingerprints and water spots can be wiped off with lens tissue or a soft cotton cloth, moistened with lens cleaning fluid. (Never clean the glass surfaces with a dry cloth or paper towel). Always dampen the glass surfaces prior to cleaning.
2. No maintenance is needed on the exterior surfaces of the riflescope except to occasionally wipe off with a soft cloth. A mild water-based cleaner is all that is required.
3. All moving parts of the riflescope are permanently lubricated. Do not try to lubricate them.
4. Other than the turret caps and quick throw lever, do not attempt to disassemble any component of the riflescope. Disassembly will void the warranty.

PRO TIP: *For a list of frequently asked questions, product instructional videos and information on service and accessories, visit our website at eotechinc.com.*

EOTECH reserves the right to change the product specifications at any time without notice. All brand names and product names referenced are trademarks, registered trademarks or trade names of their respective holders. Specifications provided in this user manual are nominal values only. Tolerance ranges consistent with industry best practices apply.

NoBS Warranty

For EOTECH Vudu Precision Riflescopes

EOTECH is proud to offer its No BS (NoBS) Lifetime warranty on its premium line of Vudu Precision Riflescopes. No BS means exactly that. No BS. EOTECH will repair or replace all issues related to materials and workmanship. We want you to be as confident in your purchase as we are in the quality of our product.

Should your Vudu rifle scope ever experience any issues, we will repair or replace it, as determined by EOTECH, with a comparable product in equal or better condition, free of charge, PERIOD. You don't have to be the original owner and you will not need to provide proof of purchase.

We understand your passion for the sport and your reliance on products that will provide years of dependable use. You can depend on EOTECH products and count on us to take care of you.

This warranty does not apply to the following:

- Theft, loss, neglect, or vandalism.
- Abuse, misuse, improper installation and modification, alterations, abnormal use, or accidents.
- Cosmetic damage that does not affect the product's use, operation or performance, as determined by EOTECH.
- Any defect or damage caused by repairs or services not performed by EOTECH.
- EOTECH products not in the Vudu line of riflescopes.

The warranty provided herein shall be the sole and exclusive warranty. There shall be no other warranties express or implied including any implied warranty of merchantability or fitness for a particular purpose or any other obligation on the part of EOTECH with respect to Vudu riflescopes covered by this warranty. EOTECH shall have no liability for any incidental, consequential, or special damages.

Service and Repair

- Visit the manufacturer's website at **eotechinc.com**.
- Navigate to the **Help Center** to complete the Return Authorization Request Form. EOTECH will provide detailed instructions on how to return your optic for repair.
- Contact EOTECH's Customer Service department by calling 888.EOTHOLE (888.368.4656) or submit a request online at **eotechinc.com**.

PRO TIP: *Do not ship the sight(s) without a return authorization number — this will severely delay the turnaround time on repair or replacement.*

Contact Information

**For prompt, professional and friendly service
contact EOTECH at:**

888.EOTHOLO (888.368.4656)
eotechinc.com

Shipping Address

EOTECH
Warranty and Service Department
1201 E. Ellsworth Road
Ann Arbor, Michigan, 48108 USA
Reference RA#

SCAN FOR
PRODUCT
REGISTRATION



SCAN FOR
WARRANTY
INFORMATION





EOTECH®

**Thank you for purchasing an
EOTECH Vudu rifle scope.**

VD1902 Rev B
April 2021

EOTECHINC.COM