



TANGO-MSR[®]

TANGO-MSR TACTICAL RIFLESCOPES

OWNERS MANUAL

SIG SAUER[®]

TABLE OF CONTENTS

Introduction	3
Contents	3
Product Identification	4
Operation	5
Illumination Brightness level	6
Sight Adjustments	8
Maintenance	10
Troubleshooting	10
SIG SAUER® Electro-Optics Infinite Guarantee™	14
SIG SAUER Electronic Component Limited 5-Year Warranty	15

INTRODUCTION

No one understands the need for accuracy better than SIG SAUER®. Our tactical riflescopes have been developed for military, law enforcement, long range hunters, and competitive shooters for one reason: When you take your shot, it will count.

CONTENTS

TANGO-MSR® Rifle

- CR2032 Battery
- Flip Back Lens Covers
- Removable Throw Lever
- Optional ALPHA-MSR Mount
- Cleaning Cloth
- Tools
- Manual

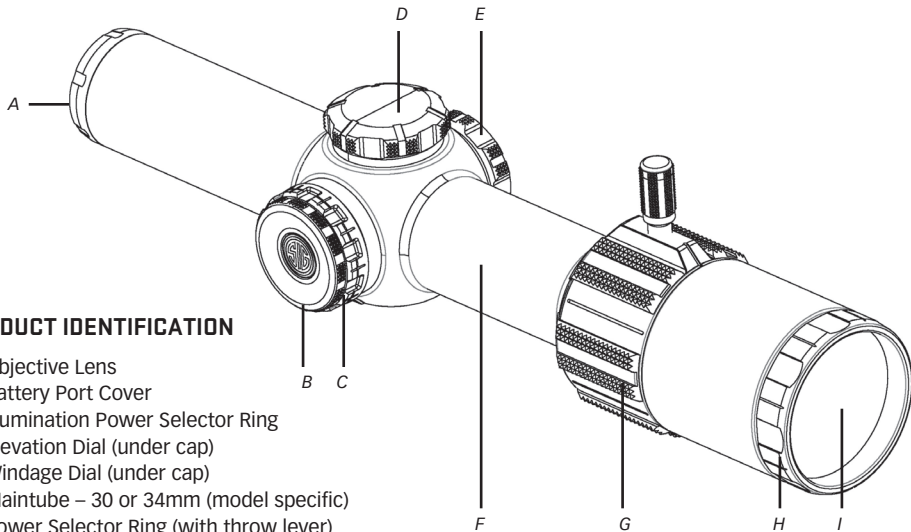

PRODUCT IDENTIFICATION

- A** Objective Lens
- B** Battery Port Cover
- C** Illumination Power Selector Ring
- D** Elevation Dial (under cap)
- E** Windage Dial (under cap)
- F** Maintube – 30 or 34mm (model specific)
- G** Power Selector Ring (with throw lever)
- H** Diopter Adjustment Ring
- I** Ocular Lens

WARNING

Before working on your TANGO-MSR® riflescope always ensure that the firearm is unloaded with the safety on.

OPERATION

Installing the battery

TANGO-MSR riflescopes are equipped with illuminated reticles and require a CR2032 battery. To install the battery loosen the battery port cover on the left side of the riflescope. Place the battery into the battery port with the plus side facing outward. Screw the battery port cover back onto the left side of the turret.

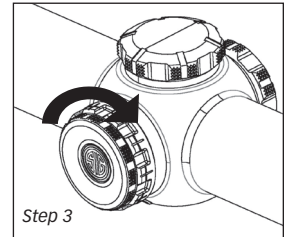
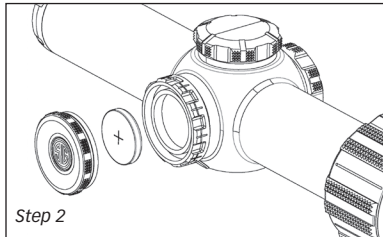
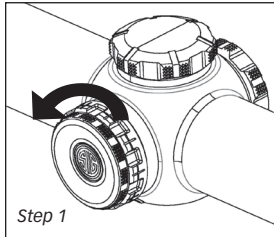

ILLUMINATION BRIGHTNESS LEVEL

- Select the illumination brightness level that suits your conditions the best
- Higher power settings, indicated by higher numbers, are better suited for brighter conditions
- Lower power settings, indicated by lower numbers, are better suited for low light conditions
- Brightness level settings alternate between on and off locations. Blank spaces between numbered positions indicate off settings

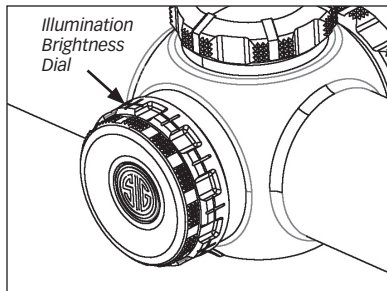

Mounting the riflescope for models that do not include a mount:

Choose rings and bases that correspond to your firearms action and the diameter of your riflescope's maintube. In order to maintain a comfortable cheek weld always mount your riflescope with the lowest possible ring height. Make sure that there is no interference with any of the moving parts of your firearm.

- Set up bases and rings based on the base and ring manual

Set proper eye relief

Slightly loosen the riflescope rings and position the riflescope as far forward as it will mount. For adjustable power riflescopes select the highest possible power. Mount the rifle in a comfortable and repeatable, natural position. Adjust the position of the riflescope backwards until you have maximum field of view in your riflescope.

Ensure that the vertical crosshair of the riflescope matches the vertical centerline of your rifle and tighten the rings and bases to the correct torque.

- To turn the illuminated reticle on rotate the illumination power selector ring to the desired level.
- To turn the illuminated reticle off rotate the illumination power selector ring to one of the dots adjacent to any numbered position.

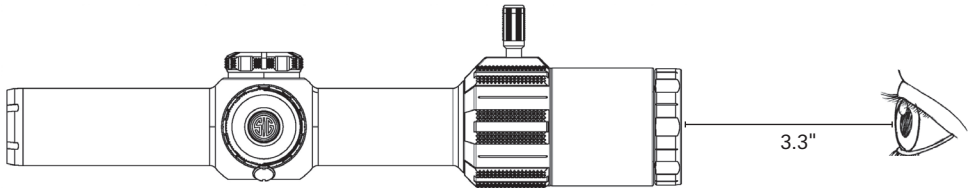

SIGHT ADJUSTMENTS

Focusing the reticle with the diopter

Aim the riflescope at a light object to maximize the contrast of the reticle. Turn the diopter until the reticle comes into focus.

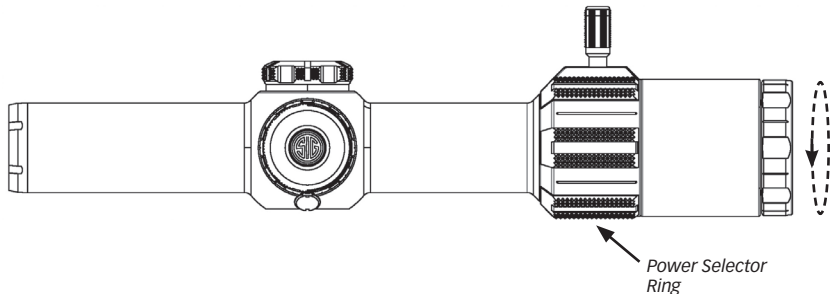

Adjusting Power

TANGO-MSR riflescopes are variable power. In order to increase the power setting rotate the power selector ring clockwise. Turn the power selector ring until the image is magnified to the desired range.

Bore sighting

If you are installing the riflescope from other than its factory settings it is best to bore site your riflescope. This will give you a coarse zero and will require further adjustments.

With the rifle in a firm rest, remove the bolt from your rifle's action (with AR style rifles remove the rifle's upper from its lower assembly and remove the bolt carrier). Look through the rifle's barrel from the rear of the rifle and aim it so that your target is centered. Without moving the position of the barrel, use the elevation and windage adjustments of your riflescope's reticle so that it is also in the center of the target.

Point of Impact (POI) corrections

POI corrections should be done using the center of a three shot group. If you are not able to get a consistent three shot group then you will need to further trouble shoot your firearm.

If your POI is located to the left of your point of aim (POA), you will need to adjust the windage to the right. To adjust the windage to the right you must unscrew the windage cap counterclockwise. To move the POI to the right turn the windage adjustment dial counter-clockwise. To move the POI to the left turn the windage adjustment dial clockwise. Upon completion re-install the windage cap by turning clockwise.

If your POI is located below your POA you will need to adjust the elevation adjustment dial up. To adjust the elevation up you must unscrew the elevation cap counterclockwise. To move the POI up you will need to turn the elevation adjustment dial counter-clockwise. To move the POI down you will need to turn the elevation adjustment dial clockwise. Upon completion re-install the elevation cap by turning clockwise.

MAINTENANCE

Your SIG SAUER riflescope requires very little maintenance.

- If your riflescope came with an illuminated reticle make sure that you turn the illumination control to one of the off positions when it is not in use.
- If the battery for your illuminated reticle is dead replace it by rotating the illumination battery port cap counter-clockwise. Replace the battery with a new CR2032 battery positive side facing out.
- Keep your lenses clean by using a soft cloth or lens pen. The best way to maintain image quality is by keeping your lenses clear of dirt and dust that cause scratches.

TROUBLESHOOTING

POI changes between groups

- Check that all of your mounts are tightened to the correct torque specification
- Check/Clean your rifle
- Check for variations in ammunition
- Ensure your mount/rings are pushed forward in the picatinny cross-slots

Illuminated reticle does not work

- Check that the battery is installed correctly
- Replace battery
- Ensure that the illumination power selector ring is in an on position

BDC6 RETICLE

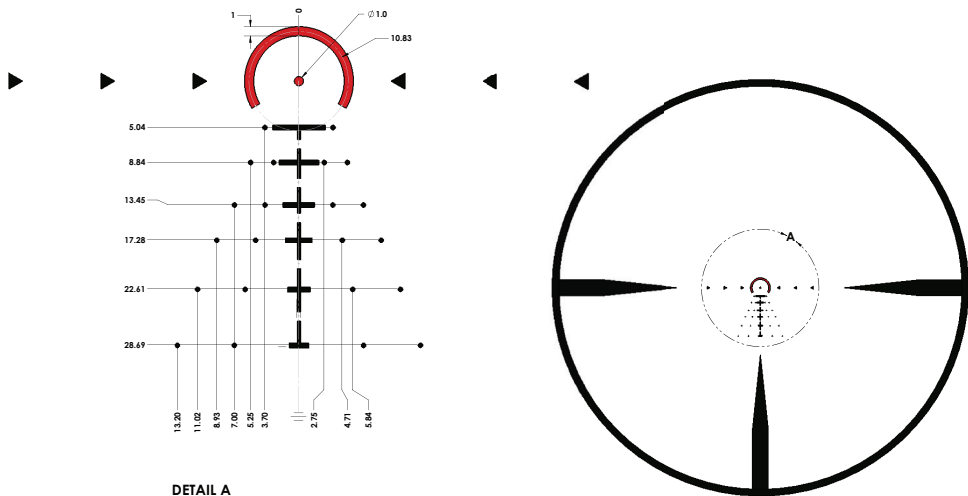

Values listed are in MOA at maximum magnification.

BDC8 RETICLE

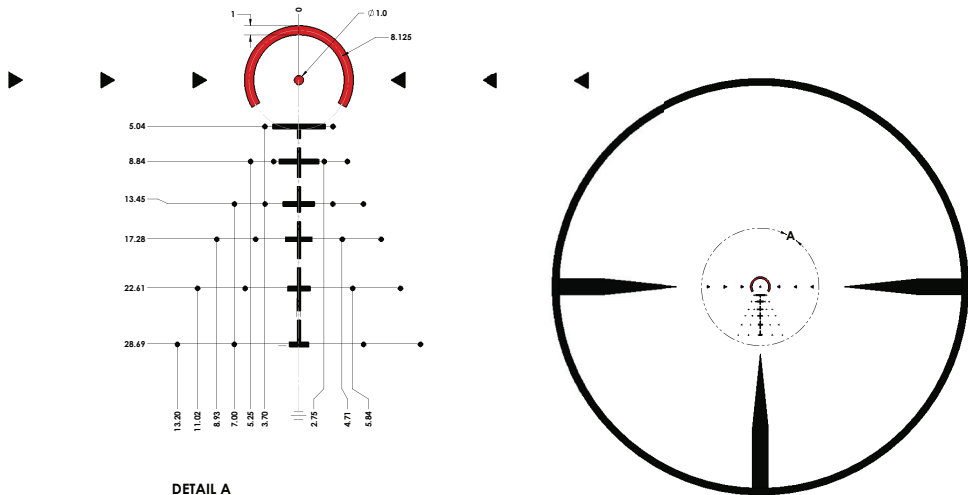

Values listed are in MOA at maximum magnification.



SIG SAUER[®] Electro-Optics Infinite Guarantee[®] / Limited Lifetime Warranty

SIG SAUER has manufactured the most rugged, dependable, high-performance firearms for more than two centuries. Our heritage of design, engineering, and precision-manufactured quality predates the existence of any other optics company worldwide.

We understand the importance of quality in the line of fire, at the shooting range or on your next hunt. SIG SAUER Electro-Optics had to earn the right to wear that badge and the Infinite Guarantee has your back, forever. Period.

We will repair or replace your SIG SAUER product in the event it becomes damaged or defective, at no charge to you. If we cannot repair your product, we will replace it with a product in perfect working order of equal or better physical condition.

SIG SAUER Infinite Guarantee[®]

- Unlimited Lifetime Guarantee
- Fully Transferable
- No Warranty Card Required
- No Receipt Required
- No Time Limit Applies
- No Charge

Please note that our Infinite Guarantee excludes coverage for intentional damage, misuse, cosmetic damage that does not affect the performance of the optic, loss, theft, or unauthorized repair or modification. Excludes electronic and Tritium components.

Customers seeking warranty coverage must first obtain a Return Merchandise Authorization (RMA) by contacting SIG SAUER Customer Service, and return the product unloaded and freight prepaid.

ANY WARRANTIES IMPLIED BY LAW, INCLUDING ANY IMPLIED WARRANTIES OF MERCHANTABILITY OR FITNESS FOR A PARTICULAR PURPOSE, ARE EXPRESSLY DISCLAIMED. REPAIR, ALTERATION, OR REPLACEMENT AS PROVIDED HEREIN IS YOUR EXCLUSIVE REMEDY FOR ANY DEFECTIVE PRODUCT. IN NO EVENT SHALL SIG SAUER OR ANY COMPANY AFFILIATED WITH SIG SAUER BE LIABLE FOR ANY SPECIAL, INCIDENTAL, OR CONSEQUENTIAL DAMAGES OF ANY KIND ARISING OUT OF THE PURCHASE OR USE OF THIS PRODUCT, WHETHER BASED UPON CONTRACT, TORT, STATUTE, OR OTHERWISE. Some states do not allow the exclusion or limitation of implied warranties, or the exclusion or limitation of incidental or consequential damages, so some or all of the above limitations or exclusions may not apply to you. This warranty gives you specific legal rights, and you may also have other rights which vary from State to State.

THIS WARRANTY APPLIES TO COMMERCIAL CUSTOMERS ONLY, AND DOES NOT APPLY TO GOVERNMENT, MILITARY, LAW ENFORCEMENT, OR NON-US CUSTOMERS. NON-US COMMERCIAL CUSTOMERS MUST PURCHASE PRODUCT THROUGH AN AUTHORIZED SIG SAUER DEALER WITHIN THEIR COUNTRY OF RESIDENCE FOR THIS WARRANTY TO APPLY.

**SIG SAUER® Electronic Component Limited 5-Year Warranty**

SIG SAUER warrants that the electronic and tritium components of the enclosed product were originally manufactured free of defects in workmanship, material, and mechanical function. For a period of five (5) years from the date of manufacture,

SIG SAUER agrees to correct any defect in these components by repair, adjustment, or replacement, at SIG SAUER's option, with the same or comparable quality components (or by replacing the product at SIG SAUER's option); provided however that a Return Merchandise Authorization (RMA) is first obtained by contacting SIG SAUER Customer Service, and that the product is returned unloaded and freight prepaid.

This limited warranty is null and void if the product has been misused, damaged (by accident or otherwise), damaged through failure to provide reasonable and necessary maintenance as described in the user's manual, or if unauthorized repair or any alteration, including of a cosmetic nature, has been performed on the product. This limited warranty does not apply to normal cosmetic wear and tear of any parts.

ANY WARRANTIES IMPLIED BY LAW, INCLUDING ANY IMPLIED WARRANTIES OF MERCHANTABILITY OR FITNESS FOR A PARTICULAR PURPOSE, ARE EXPRESSLY DISCLAIMED. REPAIR, ALTERATION, OR REPLACEMENT AS PROVIDED HEREIN IS YOUR EXCLUSIVE REMEDY FOR ANY DEFECTIVE PRODUCT. IN NO EVENT SHALL SIG SAUER OR ANY COMPANY AFFILIATED WITH SIG SAUER BE LIABLE FOR ANY SPECIAL, INCIDENTAL, OR CONSEQUENTIAL DAMAGES OF ANY KIND ARISING OUT OF THE PURCHASE OR USE OF THIS PRODUCT, WHETHER BASED UPON CONTRACT, TORT, STATUTE, OR OTHERWISE. Some states do

not allow the exclusion or limitation of implied warranties, or the exclusion or limitation of incidental or consequential damages, so some or all of the above limitations or exclusions may not apply to you. This warranty gives you specific legal rights, and you may also have other rights which vary from State to State.

THIS WARRANTY APPLIES TO COMMERCIAL CUSTOMERS ONLY, AND DOES NOT APPLY TO GOVERNMENT, MILITARY, LAW ENFORCEMENT, OR NON-US CUSTOMERS. NON-US COMMERCIAL CUSTOMERS MUST PURCHASE PRODUCT THROUGH AN AUTHORIZED SIG SAUER DEALER WITHIN THEIR COUNTRY OF RESIDENCE FOR THIS WARRANTY TO APPLY.

 **WARNING: CANCER AND REPRODUCTIVE HARM** – www.P65Warnings.ca.gov

NOTICE: Export restrictions may apply – this product may be controlled either by the ITAR or EAR.



NOTES:

NOTES:

SIGSAUER®

FOR PRODUCT SERVICE ON THIS MODEL, PLEASE CALL 603-610-3000

27100 SW Parkway Ave, Wilsonville, OR 97070 USA