

PICO

INSTRUCTION MANUAL



BERETTA

500 YEARS. ONE PASSION.

ALWAYS KEEP THIS MANUAL WITH YOUR FIREARM. INCLUDE IT WITH THE PISTOL WHEN IT CHANGES OWNERSHIP OR WHEN IT IS LOANED OR PRESENTED TO ANOTHER PERSON.

CAUTION: The Manufacturer and/or its Local Official Distributors assume no responsibility for product malfunction or for physical injury or property damage resulting in whole or in part from criminal or negligent use of the product, improper or careless handling, unauthorized modifications, use of defective, improper, hand-loaded, reloaded or remanufactured ammunition*, customer abuse or neglect of the product, or other influences beyond manufacturer's direct and immediate control.
* See page 17-18 "Ammunition".

WARNING: Always ensure that the safety is fully engaged (if present) until ready to fire. A safety, which is not fully engaged, will not prevent firearm discharge.



NOTICE: The slide will not easily release by pulling the slide to the rear when an unloaded magazine is in the pistol.

WARNING: ALL FIREARMS HAVE LETHAL POTENTIAL. READ THE BASIC SAFETY RULES CAREFULLY AND UNDERSTAND THEM FULLY BEFORE ATTEMPTING TO USE THIS FIREARM.



In addition to the Basic Safety Rules, there are other Safety Rules pertaining to the loading, unloading, disassembly, assembly and use of this firearm, located throughout this manual.

WARNING: READ THE ENTIRE MANUAL CAREFULLY BEFORE USING THIS FIREARM. MAKE SURE THAT ANY PERSON USING OR HAVING ACCESS TO THIS FIREARM READS AND UNDERSTANDS ALL OF THIS MANUAL PRIOR TO USE OR ACCESS.



WE RECOMMEND THE USE OF ORIGINAL BERETTA SPARE PARTS AND ACCESSORIES. THE USE OF OTHER MANUFACTURER'S SPARE PARTS AND ACCESSORIES COULD CAUSE MALFUNCTIONS AND/OR BREAKAGES THAT WILL NOT BE COVERED BY THE BERETTA WARRANTY.

CONTENTS

BASIC SAFETY RULES	6–10
SAFETY INSPECTION	11
REMOVING THE MAGAZINE	11–12
LOCKING THE SLIDE OPEN	12–13
FEATURES AND OPERATION	13–18
• Description	13
• Operational Features	14-15
• Ergonomic, Modular Features	15-16
• Specifications and Technical Data	16
• General Operations	17
AMMUNITION	17–18
• Ammunition	17-18
• Dry Firing & Dummy Rounds	18
LOADING AND FIRING	18–27
• Loading the magazine	19-20
• Loading the Pistol	20-22
• Load Check	21
• Unloading	22
• Unloading the Magazine	23
• Firing	24-26
FIELD STRIPPING	26–30
• Disassembly	26-28
• Reassembly	28-30

BARREL OBSTRUCTION CHECK	30–31
SIGHT ADJUSTMENT AND REPLACEMENT	31–32
GRIP HOUSING REMOVAL AND INSTALLATION	32–35
• Grip Housing Removal	32-33
• Grip Housing Installation	34
MAINTENANCE & STORAGE	35–37
TROUBLESHOOTING	37
ADVANCED MAINTENANCE	38–49
• Chassis Disassembly	38-41
• Chassis Reassembly	41-44
• Slide Disassembly/Reassembly	44-47
• Magazine Disassembly/Reassembly	47-48
• Magazine Grip Extension Disassembly	48-49
DIAGRAM & PARTS LIST	51–52
LIGHT AND LASER HOUSING INSTALLATION	53–59
• LaserMax Installation	54
• LaserMax Operation	54
• Battery Installation	55
• Aligning The Laser	56
• Cleaning	57
• Spare Parts	57

BASIC SAFETY RULES



WARNING: PLEASE READ THIS MANUAL BEFORE HANDLING YOUR FIREARM.



WARNING: FIREARMS CAN BE DANGEROUS AND CAN POTENTIALLY CAUSE SERIOUS INJURY, DAMAGE TO PROPERTY OR DEATH, IF HANDLED IMPROPERLY. THE FOLLOWING SAFETY RULES ARE AN IMPORTANT REMINDER THAT FIREARM SAFETY IS YOUR RESPONSIBILITY.

1. NEVER POINT A FIREARM AT SOMETHING THAT IS NOT SAFE TO SHOOT.

Never let the muzzle of a firearm point at any part of your body or at another person. This is especially important when loading or unloading the firearm. When you are shooting at a target, know what is behind it. Some bullets can travel over a mile. If you miss your target or if the bullet penetrates the target, it is your responsibility to ensure that the shot does not cause unintended injury or damage.



2. ALWAYS TREAT A FIREARM AS IF IT WERE LOADED.

Never assume that a firearm is unloaded. The only certain way to ensure that a firearm has the chamber(s) empty is to open the action and visually examine the chamber(s) to see if a round is present.



Removing or unloading the magazine will not guarantee that a firearm is unloaded or cannot fire. Firearms can be checked by cycling the action, removing all rounds and by then opening and inspecting the action so that a visual inspection of the chamber for any remaining rounds can be made.

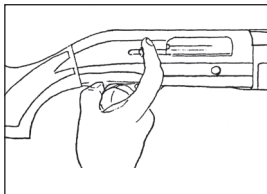
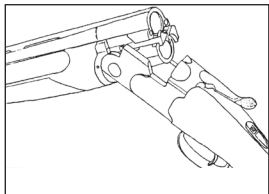

3. STORE YOUR FIREARM SO THAT CHILDREN CANNOT GAIN ACCESS TO IT.

It is your responsibility to ensure that children or other unauthorized persons do not gain access to your firearm. To reduce the risk of accidents involving children, unload your firearm, lock it and store the ammunition in a separate locked location. Please note that devices intended to prevent accidents - for example, cable locks, chamber plugs, etc. - may not prevent use or misuse of your firearm by a determined person. Firearm storage in a steel gun safe may be more appropriate to reduce the likelihood of intentional misuse of a firearm by an unauthorized child or person.

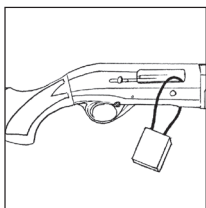
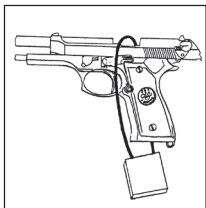

4. NEVER SHOOT AT WATER OR AT A HARD SURFACE.

Shooting at the surface of water or at a rock or other hard surface increases the chance of ricochets or fragmentation of the bullet or shot, which can result in the projectile striking an unintended or peripheral target.



5. KNOW THE SAFETY FEATURES OF THE FIREARM YOU ARE USING, BUT REMEMBER: SAFETY DEVICES ARE NOT A SUBSTITUTE FOR SAFE HANDLING PROCEDURES.

Never rely solely on a safety device to prevent an accident. It is imperative that you know and use the safety features of the particular firearm you are handling, but accidents can best be prevented by following the safe handling procedures described in these safety rules and elsewhere in the product manual. To further familiarize yourself with the proper use of this or other firearms, take a Firearms Safety Course taught by an expert in firearms use and safety procedures.

6. PROPERLY MAINTAIN YOUR FIREARM.

Store and carry your firearm so that dirt or lint does not accumulate in the working parts. Clean and oil your firearm, following the instructions provided in this manual, after each use to prevent corrosion, damage to the barrel or accumulation of fouling which can prevent use of the gun in an emergency. Always check the bore and chamber(s) prior to loading to ensure that they are clean and free from obstructions. Firing with an obstruction in the barrel or chamber can rupture the barrel and injure you or others nearby. In the event you hear an unusual noise when shooting, stop firing immediately, engage the manual safety and unload the firearm. Make sure the chamber and barrel are free from any obstruction, like a bullet stuck inside the barrel due to defective or improper ammunition.



7. USE PROPER AMMUNITION.

Only use factory-loaded, new ammunition manufactured to industry specifications: CIP (Europe and elsewhere), SAAMI® (U.S.A.). Be certain that each round you use is the proper caliber or gauge and loading for the particular firearm. The caliber or gauge of the firearm is clearly marked on the barrel(s) of shotguns or rifles and on the slide or barrel of pistols. The use of reloaded or remanufactured ammunition can increase the likelihood of excessive cartridge pressures, case-head ruptures or other defects in the ammunition that can cause damage to your firearm and injury to yourself or others nearby.

8. ALWAYS WEAR PROTECTIVE GLASSES AND HEARING PROTECTION WHEN SHOOTING.

The chance that gas, gunpowder or metal fragments will blow back and injure a shooter who is firing a gun is rare, but the injury that can be sustained in such circumstances can be severe, including the possible loss of eyesight. A shooter must always wear impact resistant shooting glasses when firing any firearm. Earplugs or other high-quality hearing protectors help reduce the chance of hearing damage from shooting.



9. NEVER CLIMB A TREE, FENCE OR OBSTRUCTION WITH A LOADED FIREARM.

Open the action and empty the chamber(s) of your firearm and engage the manual safety before climbing or descending a tree or before climbing a fence or jumping over a ditch or other obstruction. Never pull or push a loaded firearm toward yourself or another person. Always unload a firearm, visually and physically check to see that the loading mechanism and chamber are unloaded, and the magazine is unloaded or removed. Open the action before handing it to another person. Never take a firearm from another person unless it is unloaded, visually and physically checked to confirm it is unloaded, and the action is open.



10. AVOID ALCOHOLIC BEVERAGES OR JUDGMENT/REFLEX IMPAIRING MEDICATION WHEN SHOOTING.

Do not drink and shoot. If you take medication that can impair motor reactions or judgment, do not handle a firearm while you are under the influence of the medication.



11. NEVER TRANSPORT A LOADED FIREARM.

Unload a firearm before putting it in a vehicle (chamber empty, magazine empty). Hunters and target shooters should load their firearm only at their destination, and only when they are ready to shoot. If you carry a firearm for self-protection, leaving the chamber unloaded can reduce the chance of an unintentional discharge.

12. LEAD WARNING.

Discharging firearms in poorly ventilated areas, cleaning firearms, or handling ammunition may result in exposure to lead and other substances known to cause birth defects, reproductive harm, and other serious physical injury. Have adequate ventilation at all times. Wash hands thoroughly after exposure.



WARNING: It is YOUR responsibility to know and abide by Federal, State and Local laws governing the sale, transportation and use of firearms in your area.



WARNING: This firearm has the capability of taking your life or the life of someone else! Always be extremely careful with your firearm. An accident is almost always the result of not following basic firearm safety rules.

ESPECIALLY FOR U.S. CONSUMERS:

For information about Firearm Safety Courses in your area, please visit the National Rifle Association's web site at www.nra.org.

SAFETY INSPECTION

WARNING: Keep your finger OFF THE TRIGGER and the barrel pointed in a SAFE direction. Never point a firearm towards yourself or another person.



WARNING: Never assume a firearm is unloaded. Always keep the barrel pointed in a safe direction. Never point a firearm at your self or another person.



To visually check to be certain your pistol is unloaded. Retract the slide and visually inspect the firing chamber. The pistol is unloaded when no cartridge is visible when looking into the firing chamber.



WARNING: Never take a pistol from or give a pistol to another person unless the action is open and the pistol has been inspected to insure it is unloaded.



REMOVING THE MAGAZINE

The magazine release of the Pico is designed to prevent the accidental release of the magazine when concealed and during firing. The magazine release lever is pressed down rather than in, to prevent unintentional magazine release due to pressure on the side of the gun. During firing the shooting hand supports the bottom of the release lever preventing unintentional release of the magazine. To release the magazine, move your finger out from under the release lever and depress the ambidextrous lever in a curving arc with the thumb or finger releasing the magazine.



LOCKING THE SLIDE OPEN



WARNING: Keep your finger OFF THE TRIGGER and the barrel pointed in a SAFE direction. Never point a firearm towards yourself or another person.

NOTICE: The slide will release when pulled to the rear if a LOADED magazine is inserted.

NOTICE: The slide will release when pulled to the rear if NO magazine is inserted.

To lock the slide in the open position:

Remove the magazine by depressing the magazine release lever. Retract the slide to ensure the chamber is empty. Retract the slide to the rearward most position, press the slide catch up at the front and allow the slide to move forward until it engages the slide catch retaining the slide to the rear.



An alternative method of locking the slide open is to insert an unloaded magazine and retract the slide to the rear; the follower will push the slide catch up, locking the slide open.

NOTICE: The slide will remain locked in the open position when the magazine is removed.

DESCRIPTION

The Beretta Pico is the next evolution of the pocket size carry pistol. Utilizing a removable, serialized sub-chassis the Pico pistol can be easily modified with replaceable grip housings and is simple to disassemble and maintain. Ease of use and concealment were key drivers in the development of the Pico. The Pico's extremely low profile, snag-free design makes it easy to carry and draw from concealment. To accommodate right or left handed use, the Pico's magazine release lever is fully ambidextrous. The light, durable housing employs modern thermoplastic technology through the use of fiberglass reinforced techno polymer. The Pico's sights are user adjustable with a 1.3mm hex wrench and your fingers. This allows anyone to adjust or replace their sights without the assistance of a gunsmith. Modular structure, ergonomics, and ease of use make the Beretta Pico the ideal firearm for deep concealment or back up carry.

OPERATIONAL FEATURES

SEMIAUTOMATIC FIRING

Beretta Pico pistols will automatically reload after each round is fired, as long as there are cartridges in the magazine.

BARREL LOCKING SYSTEM

The barrel and slide are locked together as a unit at the time of discharge. As they move to the rear during recoil, the barrel cam operates on the disconnect pin causing the barrel to disengage from the slide and allows the slide to continue its rearward travel.

DOUBLE ACTION HAMMER FIRED SYSTEM

The Beretta Pico has a double action trigger with restrike capability and an inertia firing pin. This time tested system does not store any energy until the trigger is pulled eliminating the potential of accidental discharge if the pistol is dropped.

When the trigger is pulled the trigger bar rotates the hammer to the rear. As full trigger travel is reached, the chassis cams the trigger bar out of engagement and releases the hammer. The hammer travels forward under tension and strikes the firing pin. The firing pin travels forward under inertia. After the firing pin reaches its full forward position the firing pin return spring rebounds the firing pin to a neutral position.

SLIDE CATCH

The slide catch is the lever that holds the slide open after the last round is fired. This allows the user to immediately determine that the pistol does not have a round in the chamber or in the magazine. The Pico's slide catch is external, snag free and can be engaged manually to lock the slide back without a magazine.

MAGAZINE

The Beretta Pico pistol has an easily removable, single column magazine that allows for rapid reloading of the pistol. The standard magazine capacity is 6 rounds.

INTERCHANGEABLE, LOW PROFILE SIGHTS

The high visibility 3-dot sight system is designed for quick target acquisition. Rear and front sights can be removed for replacement with other types of sights.



WARNING: In order to permit the use of the pistol in emergency situations, even in the case of dropping or loss of the magazine, this model is **NOT** provided with a magazine disconnect safety. It is, therefore, capable of firing any time a round is chambered.

ERGONOMIC, MODULAR FEATURES

TECHNO POLYMER GRIP HOUSING

By using a glass fiber reinforced techno polymer, Beretta has developed a light and technically advanced pistol with an ergonomic shape. The rounded, snag-free surfaces of the pistol ensure trouble-free holster insertion and extraction.

ERGONOMIC AND MODULAR GRIP

The ergonomic grip housing features an optimal grip angle for sight alignment and target acquisition. The upper rear part of the grip is contoured to snugly fit and protect the shooter's hand. Both the front and the rear grip surfaces feature a comfortable textured surface to ensure a firm hold.

AMBIDEXTROUS MAGAZINE RELEASE LEVER

The magazine release lever is always ready for right-hand or left-hand use in any situation and can not be accidentally released due to pressure on the side of the pistol.

SNAG FREE EXTERNAL SLIDE CATCH

The snag free slide catch is activated by the magazine follower and can also be engaged manually.

INTERCHANGEABLE GRIP HOUSING AND SERIALIZED SUB-CHASSIS

The internal chassis of this pistol is the only serialized part. This allows any other component to be exchanged or customized without effecting the serialized part.

WARNING: Do not attempt to alter your pistol's firing mechanism. Modifying these internal parts can cause an unsafe condition.



WARNING: Altering the parts of your pistol's firing mechanism voids the manufacturer's warranty.



FIELD STRIPPING, CLEANING AND REASSEMBLY

The pistol is designed for quick and simple field stripping and to avoid unintentional disassembly. Reassembly is easy and intuitive. Improper assembly of parts is prevented by the distinctive design.

SPECIFICATIONS AND TECHNICAL DATA

MODEL:	Pico
CALIBER:	.380 Auto
MAGAZINE CAPACITY:	6 rounds
RIFLING PITCH:	1:10 in/ 250 mm
RIFLING:	R.H. – 6 Grooves
GENERAL OPERATION:	Semiautomatic, short recoil system
LOCKING SYSTEM:	Cam operated, tilt-barrel, locked breech
SIGHTS:	Removable front and rear sights on the slide
HOUSING/CHASSIS:	Stainless steel
GRIP HOUSING:	Fiberglass reinforced technopolymer
SLIDE:	Stainless Steel, bead blasted for matte finish
BARREL:	Stainless steel, bead blasted for matte finish
ACTION:	Hammer Fired
SAFETY:	Double Action Only
OVERALL LENGTH:	5.1 in/ 130 mm
BARREL LENGTH:	2.7 in/ 70 mm
OVERALL WIDTH:	.725 in / 18 mm
GRIP WIDTH:	.725 in/ 18 mm
OVERALL HEIGHT:	4.0 in/ 100 mm
SIGHT RADIUS:	3.6 in/ 91 mm
WEIGHT UNLOADED:	11.5 oz/ 325 grams with empty magazine, approximate

GENERAL OPERATION

The Beretta Pico pistol is a semiautomatic firearm using a cam operated, tilt-barrel, locking system. When the pistol is fired, the recoil energy

causes the barrel and slide assembly to move to the rear. After a short distance, the barrel is forced down and is stopped by the operation of the barrel cam and disconnect pin interface. The slide continues its rearward travel under inertia, extracting the fired case from the barrel and ejecting it through the ejection port. The recoil spring pushes the slide forward, feeding the next cartridge from the magazine into the firing chamber. Continued forward movement causes the barrel cam to raise the barrel into its locked position in the slide. The slide will be retained in the open position by the slide catch after the last cartridge has been fired and the fired shell casing ejected.

AMMUNITION

AMMUNITION (CARTRIDGE) NOTICE: Beretta specifically disclaims responsibility for any damage or injury occurring with, or as the result of using faulty, non-standard, “remanufactured”, hand-loaded or reloaded ammunition, or cartridges other than those for which the firearm was originally chambered. Serious damage or injury, even death, could result from the use of incorrect ammunition, from firing against bore obstructions and from propellant overloads. Use of improper ammunition, such as listed previously, will void the manufacturer's warranty. Use only high-quality, commercially-manufactured ammunition made in accordance with CIP (Europe and elsewhere) or SAAMI® (USA) standards. Be certain that the ammunition is the appropriate caliber and loading for the firearm and is clean, dry and in good condition. The caliber of the pistol is marked on the back of the barrel, visible from the ejection port.

NOTICE: The Beretta Pico is designed to safely use the ammunition marked as +P. The extended use of +P ammunition may decrease the component part service life expectancy.

DO NOT fire old ammunition. Primers, powder, cartridge cases, and bullets can deteriorate with time and cause damage to the firearm or injury to the shooter or others.



WARNING: Carefully inspect each cartridge before it is loaded in the magazine. Be certain the cartridge cases are not split or deformed and that the cartridges do not possess any dents or other defects.



WARNING: The Lead bullets have a tendency to cause bore leading, which may dramatically increase the discharge pressure. Be sure to remove all chamber and bore lead accumulation after each use. **DO NOT** shoot cartridges with jacketed bullets through a barrel previously fired with lead bullets before the lead is thoroughly removed from the barrel.

DRY FIRING & DUMMY ROUNDS

Dry firing is defined as firing a firearm with no ammunition in the chamber. Long term dry firing of your Beretta Pico pistol may result in damage to the firing pin. “Snap Caps” (inert chamber inserts that allow a firearm to be dry-fired without damaging the firing pin) are available at most gun stores for those who wish to practice firing without live ammunition.

CAUTION: “Dummy Rounds” with empty primer pockets are suitable for loading/unloading practice but **DO NOT PROTECT** the firing pin tip during dry firing.

LOADING



WARNING: Whenever a live round is in the chamber, this pistol can fire, even if the magazine is empty or has been removed.



WARNING: Before loading the firearm, become familiar with the following loading procedures without the use of ammunition. Never handle a loaded firearm until you are familiar with the loading procedures.



WARNING: Always keep your finger away from the trigger until you are prepared to fire.

WARNING: Load the chamber only when ready to fire.

LOADING THE MAGAZINE



WARNING: Be sure that you have the correct cartridges for your pistol.



TO LOAD THE MAGAZINE:

Remove the magazine from the pistol by pushing the magazine release lever down.



Hold the magazine in one hand. With the other hand, place a cartridge on the magazine follower in front of the feed lips at the top of the magazine. Press the cartridge down onto the follower and slide the cartridge under the feed lips until it is seated fully inside the magazine body.

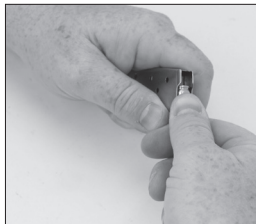

Subsequent rounds are loaded by placing the next cartridge to be loaded on the previous cartridge in front of the feed lips and behind the case mouth and pressing the cartridge down on to the previous round

in the magazine and sliding the cartridge under the feed lips until it is seated fully inside the magazine body.

Repeat this process until magazine is fully loaded. The holes on the side of the magazine allow for visual counting of cartridges.

CAUTION: Do not try to force more than the maximum number of rounds indicated into the magazine. An overloaded magazine may not function properly.

LOADING THE PISTOL



WARNING: Beretta assumes no responsibility for any injury or property damage resulting from improper or careless handling, intentional or accidental discharge of the firearm.



WARNING: Be sure that the obstruction check has been completed prior to loading (30-31) .



WARNING: Point the firearm in a safe direction. Do not touch the trigger until you are ready to fire and are sure of your target and backstop.

The firing chamber is the portion of the barrel into which the cartridge is fed. The Pico is designed as a controlled-round-feed firearm, meaning that the round is always controlled on its way to the chamber: First its controlled by the feed lips and then by the extractor. Due to the nature of this robust feeding method, it is recommended that the firing chamber should always be loaded from a magazine. While loading single cartridges into the chamber and snapping the slide closed is acceptable, it will result in reduced extractor life, and is not recommended.

Completely push the loaded magazine into the pistol grip to ensure magazine catch engagement. Pull back the slide and release it. The slide will automatically pick up a cartridge from the top of the magazine and feed it into the firing chamber.



WARNING: THE FIREARM YOU ARE HANDLING AT THIS POINT IS LOADED WITH A LIVE ROUND IN THE CHAMBER. Keep your finger away from the trigger whenever you do not intend to fire.



REPLACING A ROUND THAT HAS BEEN CHAMBERED FROM THE MAGAZINE

WARNING: Make sure your finger is not on the trigger or inside the trigger guard



Remove the magazine from the pistol by pressing the magazine release lever.

Insert one more cartridge into the magazine. Completely push the loaded magazine into the pistol grip to ensure magazine catch engagement.

LOAD CHECK

WARNING: Keep your finger **OFF THE TRIGGER** and the barrel pointed in a **SAFE** direction. Never point a firearm towards yourself or another person.



Retract the slide slightly and visually inspect the firing chamber. The pistol is loaded when a cartridge is visible when looking into the firing chamber.



UNLOADING



WARNING: Always unload the firearm whenever you do not intend to shoot.



WARNING: Be certain the pistol is pointed in a SAFE direction. Keep your finger away from the trigger.

Remove the magazine from the pistol. Grasp the rear of the slide with your thumb and index finger while holding the pistol by the grip in your other hand and fully retract the slide to remove the chambered cartridge. When you are sure that the chamber is empty and the cartridge has been ejected, release the slide. Then unload the magazine.



WARNING: Always visually inspect the firing chamber to ensure that it is empty. The chamber is empty when no cartridge is visible when looking from the ejection port into the back of the barrel with the slide to the rear.

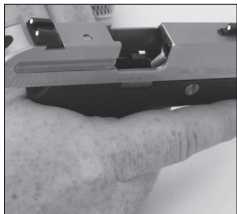

WARNING: If you eject an unfired cartridge use extreme care, be sure they are ejected onto an appropriate surface.



WARNING: Never allow anything to strike the primer of unfired ammunition, doing so could cause the ammunition to discharge.



WARNING: Releasing the fully retracted slide when a loaded magazine is in the pistol will feed a cartridge into the pistol's firing chamber and the pistol will be able to fire immediately.



NOTE: It is recommended to store the firearm unloaded, slide closed, with the magazine empty.

UNLOADING THE MAGAZINE

TO UNLOAD THE MAGAZINE:

Grasp the magazine with one hand around the magazine box, bottom down and front end forward.

With the tip of the thumb firmly press down on the cartridge rim and push towards the front of magazine box.

As the cartridge moves forward, tip it slightly upward with the index finger and slide it out of the magazine with your thumb.

Repeat until the magazine is unloaded.

FIRING



WARNING: Beretta assumes no responsibility for any injury or property damage resulting from improper or careless handling, intentional or accidental discharge of the firearm.



WARNING: Be certain the firearm is pointed in a SAFE direction. Never put your finger on the trigger unless you intend to shoot.



WARNING: High-quality eye and ear protection should be worn by all present when firing any firearm.

TO FIRE THE PISTOL:

First load the pistol by following the “**LOADING**” instructions, (pages 20-21).



WARNING: THE PISTOL IS NOW READY TO FIRE.

Then, without placing your finger on the trigger or inside the trigger guard, point the pistol at the intended target. Aim the pistol by aligning the front sight in the notch of the rear sight. Point the front sight at 6 o'clock in the center of the target. The front sight should be in focus, the target and the rear sight slightly blurred or out of focus.

WHEN YOU ARE READY TO FIRE:

Place your index finger inside the trigger guard.



WARNING: Ensure that fingers or other parts of the hands and the face are kept away from the slide. Ignoring this warning can lead to serious injury. During the firing cycle, the slide moves to the rear violently and with great energy. Ensure that the hands are kept away from the muzzle of the barrel.

Squeeze the trigger, being careful not to upset the alignment of the front and rear sights. **THE PISTOL WILL FIRE.** The discharge will force the slide and barrel to the rear, which will in turn eject the fired cartridge case and compress the recoil spring. Then the slide will close,

feeding the next cartridge from the magazine into the chamber.

WARNING: THE PISTOL IS STILL LOADED AND READY TO FIRE.

Keep your finger away from the trigger whenever you do not intend to fire.



When the last round has been fired the slide will remain open.

To fire again, remove the empty magazine and insert a loaded one. Pull the slide to the rear and release it to close the slide and load the chamber.

When you have completed shooting, remove the magazine, check that the firing chamber is empty, see “**UNLOADING**” (pages 22-23) and close the slide by pulling the slide to the rear to release the slide lock.

WARNING: Always unload the firearm immediately after shooting is completed. Never store a loaded firearm. To store the pistol see the section “**STORAGE**” (page 37).



WARNING: If when the trigger is pulled the firearm does not immediately discharge, do the following:



Keep the firearm pointed in a **SAFE** direction in the event a “hang-fire” occurs. A hang-fire occurs when there is a delay in a cartridge’s ignition. With the pistol pointed in a **SAFE** direction, wait one (1) full minute. After one (1) full minute has elapsed, completely unload the firearm by following the “**UNLOADING**” instructions in this manual (pages 22-23).

Carefully inspect your ammunition. Immediately refer to a qualified gunsmith if the firing pin indent on the cartridge’s primer is off-center or does not exist. Following the “**FIELD STRIPPING**” instructions (pages 26-28) and remove the barrel from the slide and look down the barrel to make sure that no obstruction exists. If a barrel obstruction is detected, a qualified gunsmith must remove the obstruction and inspect the pistol before it can be fired.



WARNING: If another cartridge is fired into an obstructed barrel, catastrophic failure can result.



WARNING: If, while firing, you hear a change in the sound of a fired cartridge, or feel a change in the amount of recoil, or detect any other irregularity, **CEASE FIRING IMMEDIATELY** and do the following:

Keep the firearm pointed in a **SAFE** direction. A “squib load” may have occurred. A “squib” occurs when a cartridge fires, but with insufficient force to drive the bullet out of the barrel. This can result in a dangerous bore obstruction.

With the gun pointed in a **SAFE** direction, completely unload the firearm by following the “**UNLOADING**” Instructions (pages 22-23). Following the “**FIELD STRIPPING**” instructions (pages 26-28), remove the barrel, then look down the barrel to make sure that no obstruction exists.



WARNING: NEVER attempt to reuse or fire ammunition that did not fire the first time. Dispose of unfired or damaged ammunition properly, per the ammunition manufacturer’s recommendation.

FIELD STRIPPING



WARNING: Make sure the pistol is unloaded. If not, unload it following the “**UNLOADING**” instructions in this manual (pages 22-23).

NOTICE: It is advisable to perform field stripping and assembly operations over a table to catch components should they drop.

Remove the magazine and ensure the pistol is unloaded by inspecting the barrel’s chamber and allow the slide to close.

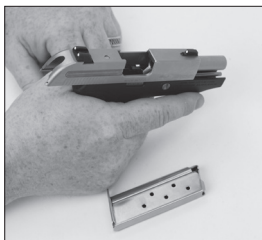

Rotate the Disassembly Pin approximately $\frac{1}{4}$ turn counterclockwise to disengage the pin from the barrel.



NOTE: a coin, rim of a cartage case or the base plate of the magazine can be used to turn the disassembly pin.
Move the slide forward and remove it from the grip housing.



The recoil springs and guide can now be lifted out of the slide

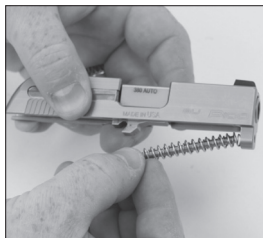

NOTICE: The recoil springs are not captured, a hand should be placed behind the recoil spring guide to prevent its loss. Tilt the barrel by grasping the cam lug and remove the barrel from the slide.



WARNING: The recoil spring guide is held under pressure by the recoil spring. Be careful not to inadvertently cause this unit to “shoot off” the barrel slide assembly.

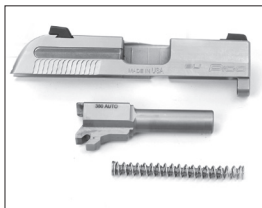
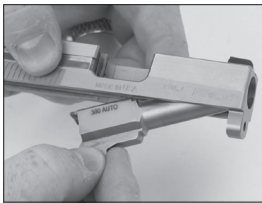

NOTICE: No further disassembly is required for routine maintenance.

REASSEMBLY

Reassemble by inserting the barrel into the slide. Tip the barrel to install the muzzle end through the hole in the front of the slide, then lower the rear end into position in the slide.



Install the recoil springs and guide with the large flat end engaged into the recess in the barrel cam lug.



WARNING: The recoil spring guide is held under pressure by the recoil spring. Be careful not to inadvertently cause this unit to “spring off” the barrel slide assembly.



NOTICE: If the slide is released when under spring pressure and the Disassembly Pin is not in the “Locked” position, the slide can be propelled off the grip housing.

Check that the disassembly pin has the flat side up and install the slide assembly on the grip housing.

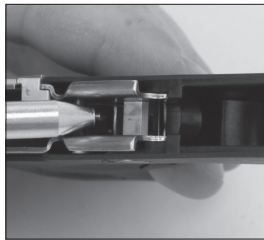

With the muzzle pointed in a safe direction, slowly retract the slide and visually confirm that the Disassembly Pin has returned to the “LOCKED” position.

NOTICE: If the slide is released when under spring pressure and the Disassembly Pin is not in the “Locked” position, the slide can be propelled off the grip housing.



BARREL OBSTRUCTION CHECK



WARNING: Catastrophic failure can result if a cartridge is fired into an obstructed barrel.

If you believe the barrel might be obstructed follow the “**FIELD STRIPPING**” operations and disassemble the pistol (pages 26-28).

After disassembly, look down the barrel and check to be sure there are no obstructions in the chamber or bore.

If an obstruction in the barrel is detected, a qualified gunsmith **MUST** remove the obstruction and inspect the pistol to ensure it is safe before it can be fired.

If no obstruction is found, reassemble the pistol by following the procedures given in the “**REASSEMBLY**” section of this manual (Pages 28-30).

SIGHT ADJUSTMENT AND REPLACEMENT

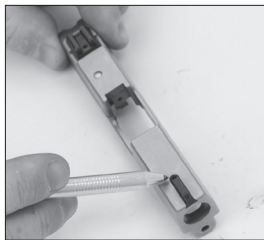

The sights of the Pico are designed to be easily adjusted or replaced using a 1.3 mm hex wrench.

To adjust the rear sight loosen the set screw, adjust the location of the sight in the same direction that you want to move the point of impact and retighten the set screw.

To replace the sights, loosen the set screws on the front and rear sights and slide them out of the slide and install the new sights as indicated by the maker of the new sights. It is recommended to use a low strength thread locker such as Loctite® 222 (purple).

CAUTION: When tightening the set screws that hold the sights, grasp the hex wrench by the short end to avoid over tightening and stripping the hex driver out of the set screws.

NOTE: It is recommended as part of your normal maintenance routine to check for loosened set screws and tighten as necessary.

GRIP HOUSING REMOVAL

Beretta Pico pistols have a sub-chassis that carries the serial number and firing mechanism. The grip housing can be easily removed for maintenance or to be replaced with an alternate unit.

TO REMOVE THE GRIP HOUSING:



WARNING: Make sure the pistol is unloaded. If not, unload it following the “**UNLOADING**” instructions in this manual (pages 22-23).

Field strip the pistol following the “**FIELD STRIPPING**” instructions in this manual to remove the slide assembly (pages 26-28).

Rotate the disassembly pin until the round portion of the pin is up and the screw slot aligns with the index line on the frame under the directional arrow, this will align the disassembly pin with a keyway and allow it to be removed. Push the disassembly pin out from left to right and set it aside.

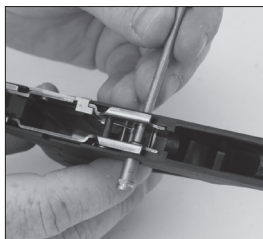

NOTE: The recoil spring guide can be used to push the disassembly pin out.

Pull the front rails of the chassis up and forward and the chassis assembly will pull out of the grip housing.



NOTE: The chassis assembly has been designed with inter locking parts so that when the chassis is removed from the grip housing, parts will not fall off and become lost.

NOTE: The magazine release lever should not be removed from the frame unless the lever or spring need to be replaced. The lever spring can be easily lost or damaged when removed from the grip housing.

GRIP HOUSING INSTALLATION

Insert the chassis assembly back end first into the grip housing while moving the trigger back enough to allow it to pass through the trigger hole in the grip housing.



Press the chassis into the grip housing until the rear slide rails are seated on the top surface of the grip housing and the disassembly pinholes in the chassis and grip housing align.



Insert the disassembly pin into the grip housing from right to left with the round part of the pin up to allow the flat on the disassembly pin to align with the keyway and press the pin in until it seats on the chassis then rotate the disassembly pin until the flat side of the disassembly pin is up.

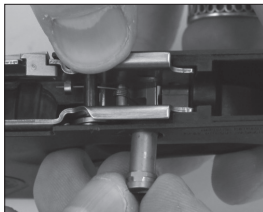

MAINTENANCE

The firearm should be cleaned as soon as possible after firing. Use only high-quality, commercially available firearm cleaning solvents, gun oil and cleaning equipment. Field strip the pistol as indicated in the “FIELD STRIPPING” section of this manual (pages 26-28).

WARNING: Excess oil and grease obstructing the bore, even partially, is very dangerous when firing and may cause barrel damage and serious injury to the shooter and bystanders. Never spray or apply oil to the cartridges. Use lubricants properly. You are responsible for the proper care and maintenance of your firearm.



BARREL

Apply gun oil to a bore-cleaning brush. Insert the brush into the barrel from the chamber end and scrub the chamber and bore thoroughly. If necessary, first clean the bore with a barrel cleaning solvent. Dry the chamber and bore by pushing a cloth patch through the chamber and bore with a brush or cleaning jag. Repeat with a new patch until it emerges clean. Clean the outside of the barrel with a cloth soaked in gun oil. Lightly oil the entire barrel prior to reassembly.

CAUTION: DO NOT clean the barrel with the pistol assembled.

NOTICE: Cleaning the barrel from the breech (chamber) end will avoid damaging the muzzle.

SLIDE

Clean the slide with a cloth soaked in gun oil paying particular attention to the breech face, extractor, slide rails and locking shoulders. If necessary, use a **NYLON** cleaning brush to remove fouling before cleaning with the cloth. Dry slide surfaces with a clean cloth and lightly oil the slide. Place a few drops of oil on the side rails and smooth it out throughout the length of the rails. Likewise oil underside of breech and spread the length of the feed strip. Check the firing pin to make sure that it can move freely before reassembling the pistol. If the firing pin sticks, disassemble the slide and clean the individual parts. It is recommended as part of your normal maintenance routine to check for loosened set screws and tighten as necessary.

CAUTION: When tightening the set screws that hold the sights, grasp the hex wrench by the short end to avoid over tightening and stripping the hex driver out of the set screws.

RECOIL SPRINGS AND SPRING GUIDE

Clean the recoil springs and spring guide with a cloth soaked in gun oil. Lightly oil the spring guide with gun oil.

GRIP HOUSING

Using a cloth soaked in gun oil, clean the areas of the hammer, ejector, slide rails, slide catch and magazine well. If necessary, use a **NYLON** cleaning brush. If the pistol is very dirty or debris has gotten into the grip housing (sand, dirt, food, soda, etc.) it may be necessary to disassemble the chassis and clean the individual parts with a **NYLON** cleaning brush and a cloth soaked in gun oil. Lightly oil the slide rails and moving parts before reassembling the pistol.

MAGAZINE

Make sure the magazine is thoroughly clean and that the follower slides easily downward if pressed. Dry the internal walls of the magazine box with a cloth. Do not leave any oil in the magazine.

CAUTION: Do not apply excess oil. Excess oil attracts dirt and dust, which can interfere with the functioning and reliability of the firearm.

STORAGE

WARNING: Always store the pistol **UNLOADED**, with the magazine empty.



WARNING: Always store your firearm so that children cannot gain access to it. To reduce the risk of accidents involving children, unload your firearm, lock it, and store the ammunition in a separate locked location.



CAUTION: Before storage, always check the condition of the pistol and its case. Make sure the case is dry and that the firearm is dry and oiled. Moisture can damage the pistol over time.

TROUBLESHOOTING

WARNING: Do not attempt to make repairs to any firearm without proper knowledge or training. Do not alter the firing mechanism or use substitute parts in the firing mechanism not made by Beretta. Any necessary alterations or adjustments to the operating mechanism should be performed by the Manufacturer or by its Local Official Distributor or Authorized Repair Center.



WARNING: Do not attempt to alter the internal parts of your pistol's firing mechanism. Altering internal parts can cause an unsafe condition.



WARNING: Altering the internal parts of your pistol's firing mechanism voids the manufacturer's warranty.



If you are having a problem with the operation or maintenance of your Beretta Pico please contact Beretta USA either online at www.beretta.com or by telephone at 1-800-Beretta (237-3882).

NOTICE: PAGES 38-49 CONTAIN INFORMATION THAT IS NOT NEEDED FOR NORMAL MAINTENANCE. IT IS PROVIDED TO ALLOW YOU TO PERFORM MORE ADVANCED MAINTENANCE. IF YOU ARE NOT CONFIDENT TO PERFORM THE OPERATIONS DESCRIBED, BERETTA RECOMMENDS TAKING YOUR PISTOL TO A COMPETENT GUNSMITH FOR SERVICE.

CHASSIS DISASSEMBLY / REASSEMBLY

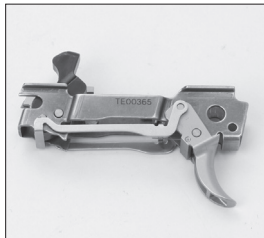

NOTE: The chassis does not need to be disassembled for normal maintenance.

NOTE: Read this section completely before proceeding. The parts contained in the chassis assembly have been designed to interlock so that when the chassis is removed from the frame parts do not fall off and get lost. Because the parts interlock, the order of disassembly and reassembly is important.

DISASSEMBLY

1. Unhook the legs of the trigger spring from their seats on the trigger bar and allow them to rest against the disconnect pin.

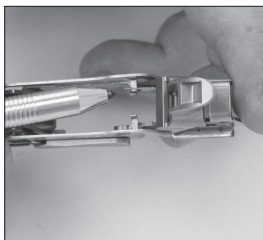

2. Gently spread the trigger bar legs just enough to slide them off of the lugs on the trigger and remove the trigger bar.



3. Push out the trigger pin and remove the trigger and trigger spring.

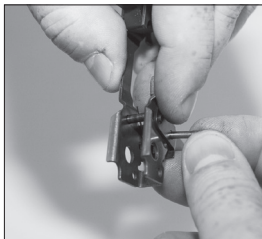

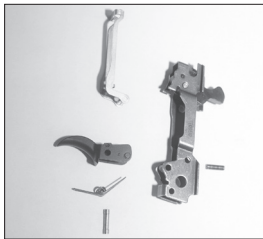

NOTE: The trigger spring retains the trigger pin. Driving the trigger pin out before releasing the tension on the trigger spring could damage the spring.

NOTE: When trigger is removed the disconnect pin will fallout.

4. Remove the slide catch spring by holding the slide catch down to the top of the chassis and pressing the top leg of the slide catch spring down just behind the slide catch until the spring clears the bottom of the catch then pull the top leg of the spring away from the frame and unhook it from the slide catch. Then slide the loop of the spring over the hammer pin and unhook the bottom leg from the chassis.

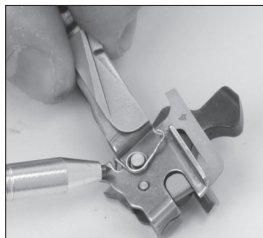

5. Rotate the slide catch until the slide catch retaining lug is aligned with the assembly notch in the chassis then pull out on the slide catch and remove it from the chassis.

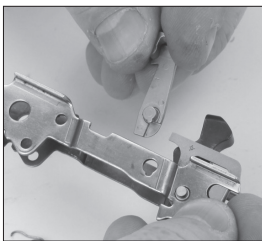
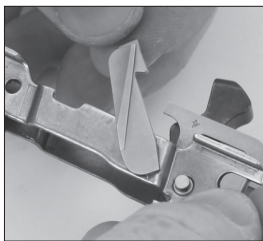

NOTICE: No further disassembly is recommended.

REASSEMBLY

1. Install the slide catch by aligning the retaining lug on the slide catch with the assembly notch in the chassis and sliding the slide catch into place.



2. Install the slide catch spring. First hook the bottom leg of the spring into the notch in the chassis. Then slip the loop of the spring over the hammer pin. Then depress the top leg of the slide catch spring while holding the slide latch against the top of the chassis until the top leg of the spring can be slid between the slide latch and the chassis and onto its seat.

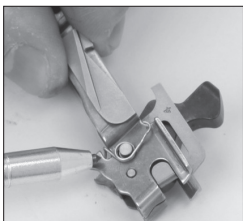

3. Support the chassis with a finger blocking the bottom of disconnect pinhole, and drop the disconnect pin down through both sides of the chassis.

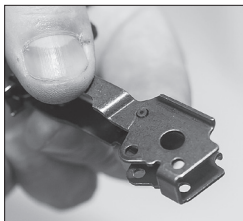
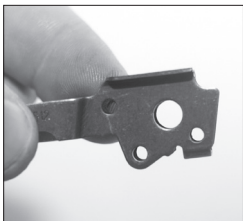

Slide the trigger onto the chassis so that it covers the disconnect pin.



4. Feed the trigger spring, closed end first, between the bar on back of the trigger and the disconnect pin. Then angle the closed end down into the trigger where it will bear on the backside of the trigger.

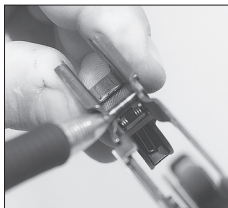

Wiggle the trigger pin through the trigger, chassis and trigger spring and completely through the opposite side of the chassis and trigger.

NOTE: Closed loop of trigger spring bears against the trigger. The upper legs of the trigger spring bear against the disconnect pin.

5. Move the trigger to the front.



Spread the trigger bar just enough to allow it to slide into place on its lugs on the trigger.



6. Hook the legs of the trigger spring onto their seats on the trigger bar.

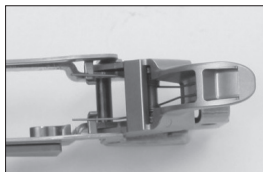
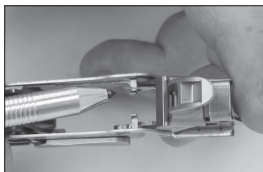

The chassis is now assembled.

SLIDE DISASSEMBLY / REASSEMBLY

NOTE: Disassembly of the slide is not required for normal maintenance.

NOTE: Read this section completely before proceeding.

DISASSEMBLY

Press the extractor into the slide just behind the extractor pin and push the extractor pin out from the bottom of the slide.

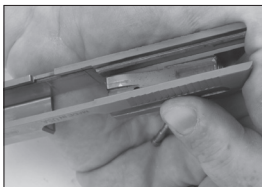

NOTE: The slide is designed so that it can be disassembled with a minimum number of tools. The extractor pin is stepped and is retained by the spring tension of the extractor **DO NOT** drive the pin out with a hammer. If the pin does not press out easily try changing the pressure applied to the side of the extractor or shifting the extractor back and forth in its slot while depressed.

Remove the extractor, firing pin, and firing pin spring.

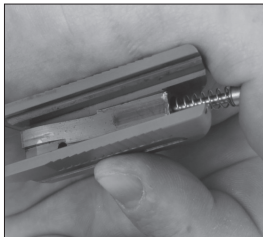

NOTE: The firing pin is retained by the extractor. Once the extractor is removed the firing pin is free to fly out under spring tension from the firing pin spring. Placing a hand behind the slide to catch the firing pin when the extractor is removed is recommended.

ASSEMBLY

Place the firing pin spring on the front of the firing pin and slide it into the back of the slide with the groove in the firing pin aligned with the extractor cut.



Place the extractor in position and firmly press on the side of the extractor while pressing the firing pin into place. The extractor will hold the firing pin in place.



NOTE: The recoil spring guide can be used to press the firing pin into place.

Press in on the extractor allowing the extractor pin holes to align and press the extractor pin into position.

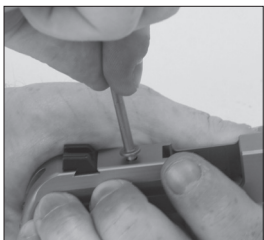

The extractor has a small amount of fore and aft movement by design.
The slide is now assembled.

MAGAZINE DISASSEMBLY / REASSEMBLY

NOTE: The magazine does not need to be disassembled for normal maintenance.

NOTE: Read this section completely before proceeding

NOTE: The magazine must be unloaded before disassembly.

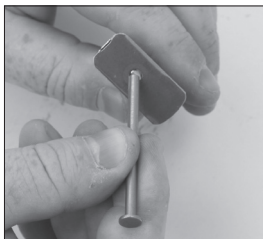

DISASSEMBLY

Depress the magazine floor plate retaining plate and slide the floor plate forward and off of the magazine. The retaining plate, magazine spring, and follower can now be removed.

ASSEMBLY

Install the follower then install the magazine spring with the higher end of the magazine spring to the front of the magazine. Compress the magazine spring into the magazine body with the retaining plate with the boss facing down and slide the floor plate into position. The boss on the retaining plate will lock into the floor plate when the magazine is assembled properly.

MAGAZINE EXTENDED GRIP

NOTE: The magazine does not need to be disassembled for normal maintenance.

NOTE: Read this section completely before proceeding

NOTE: The magazine must be unloaded before disassembly.



DISASSEMBLY

Depress the pin in the center of the floor plate until the floor plate can slide off the magazine bottom. The floor plate retainer, magazine spring and follower can now be removed.

NOTE: The retaining plate is under spring tension from the magazine spring. Removing the floor plate will release the spring, make sure to retain the spring and retaining plate when the floor plate is removed.

ASSEMBLY

Install the follower then install the magazine spring with the higher end of the magazine spring to the front of the magazine. Compress the magazine spring into the magazine body with the retaining plate with the boss facing down and slide the floor plate into position. The boss on the retaining plate will lock into the floor plate when the magazine is assembled properly. Then press the retaining plate pin down and slide grip extension on the retaining plate rails. When it snaps onto pin it should be secure.

TROUBLESHOOTING

WARNING: Do not attempt to make repairs to any firearm without proper knowledge or training. Do not alter parts or use substitute parts not made by Beretta. Any necessary alterations or adjustments to the operating mechanism should be performed by the Manufacturer or by its Local Official Distributor.



WARNING: Do not attempt to alter the internal parts of your pistol's firing mechanism. Altering internal parts can cause unsafe condition.



WARNING: Altering the internal parts of your pistol's firing mechanism voids the manufacturer's warranty.



MALFUNCTION	PROBABLE CAUSE	REMEDY
Mis-introduction of a cartridge into the chamber	Defective cartridge	Inspect and replace cartridge
Mis-fire	Defective cartridge	Replace cartridge
Mis-extraction or defective extraction	Dirty cartridge chamber	Clean cartridge chamber
	Defective or dirty ammunition	Replace or clean cartridges
	Dirt under the extractor	Clean the extractor seat

SERIAL NUMBER: _____

DATE PURCHASED: _____

PURCHASE PRICE: _____

DEALER INFORMATION: _____

The illustrations and descriptions given in this brochure are intended as a general guide only, and must not be taken as binding. The Company, therefore, reserves the right to make, at any moment and without prior notice, any changes it thinks necessary to improve its models or to meet any requirements of manufacturing or commercial nature.

Beretta USA Corp. • 17601 Beretta Drive • Accokeek, MD 20607

1-800-Beretta

www.beretta.com

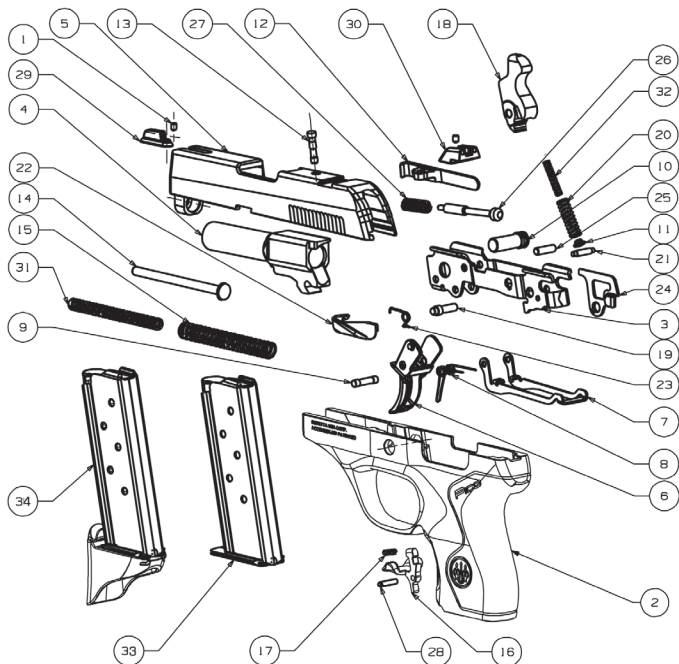

PC NO	PART NAME	PART NO.
1	SET SCREW 2.5MMX3LG	UD5A1043
2	GRIP HOUSING	UD5A1054
3	CHASSIS	UD5A1055
4	BARREL, .380ACP	UD5A1056
5	SLIDE	UD5A1057
6	TRIGGER	UD5A1058
7	TRIGGER BAR	UD5A1059
8	TRIGGER SPRING	UD5A1060
9	TRIGGER PIN	UD5A1061
10	DISASSEMBLY PIN	UD5A1062
11	HAMMER SPING, PLUNGER	UD5A1063
12	EXTRACTOR	UD5A1064
13	EXTRACTOR PIN	UD5A1065
14	RECOIL ROD	UD5A1066
15	RECOIL SPRING, OUTER	UD5A1067
16	MAGAZINE CATCH	UD5A1073
17	MAGAZINE CATCH, SPRING	UD5A1074
18	HAMMER	UD5A1075
19	HAMMER, PIN	UD5A1076
20	HAMMER SPRING, OUTER	UD5A1077
21	HAMMER SPRING, PIN	UD5A1078
22	SLIDE CATCH	UD5A1079
23	SLIDE CATCH, SPRING	UD5A1080
24	EJECTOR	UD5A1081
25	DISCONNECT PIN	UD5A1084
26	FIRING PIN	UD5A1085
27	FIRING PIN SPRING	UD5A1086
28	MAGAZINE CATCH, PIN	UD5A1102
29	FRONT SIGHT, WHITE DOT	UD5A1155
30	REAR SIGHT, WHITE DOT	UD5A1156
31	RECOIL SPRING, INNER	UD5A1247
32	HAMMER SPRING, INNER	UD5A1298
33	MAGAZINE ASM, FLUSH	UD8A0341
34	MAGAZINE ASM, EXTENSION	UD8A0367

PICO

LIGHT AND LASER HOUSING INSTALLATION MANUAL



LaserMax



BERETTA

500 YEARS. ONE PASSION.

NOTE: Select PICO models come factory equipped with a LaserMax Laser or Light housing.

Visit Beretta.com to purchase grip housing separately.

LASERMAX INSTALLATION

Please refer to your Beretta PICO manual for grip housing removal and installation.

LASERMAX OPERATION

There is a tap-on/tap-off activation switch on either side of the grip housing. Tap the button once to activate the light or laser. Tap again to deactivate.



To change the laser or light from constant to pulsing mode, first, turn the laser on, then press and hold the activation switch for approximately three seconds. Repeat the process to return to previous mode.

BATTERY INSTALLATION

LIGHT:

Remove battery cover with Phillips head screwdriver (not included).
Insert CR2 Lithium battery and reinstall battery cover.

TIP: Battery cover tab must line up with grip housing notch.

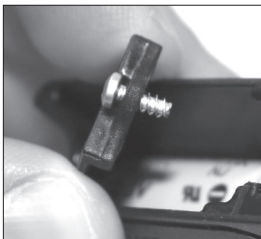
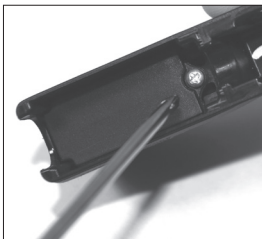

LASER:

Remove battery cover with Phillips head screwdriver (not included).
Only remove the screw labeled "BATTERY." Insert 1/3N battery and
reinstall battery cover.

TIP: Battery cover notch must line up with the grip housing tab.

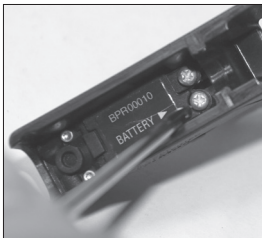

ALIGNING THE LASER



WARNING: Make sure the pistol is unloaded. If not, unload it following the “UNLOADING” instructions in this manual (pages 22-23).

While pointing the muzzle in a safe direction, turn windage screw clockwise for right, counterclockwise for left. Turn elevation screw clockwise (as viewed from above firearm) for down, counterclockwise for up.

NOTE: You may experience a one-time shift in alignment after firing the first few rounds. Recheck alignment and adjust if necessary.



Windage



Elevation

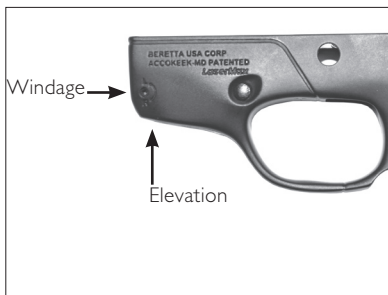

CLEANING

WARNING: Make sure the pistol is unloaded. If not, unload it following the “**UNLOADING**” instructions in this manual (pages 22-23).



Over time, your laser or light lens could become clouded with powder residue. In order to remove this residue:

Keep firearm pointed in a safe direction. Confirm laser or light is off.

Take a standard cotton swab and dampen end with isopropyl alcohol.

Apply dampened swab to the laser or light lens and rotate in a small circular pattern removing any residue. Be sure to clean around the edges of the lens.

For best results, it is recommended that the laser or light lens be cleaned along with your firearm after each use.

SPARE PARTS

LMS-AT50	Adjustment tool (for laser)
LMS-2x13N	1/3N battery (2 pack for laser)
LMS-CR2	CR2 battery (for light)

For patent information, please visit:
www.lasermx.com/sevice/patents.aspx.

01785-0-54
 5/14



**IF YOU EXPERIENCE
AN ISSUE WITH
YOUR PICO, PLEASE
DO NOT RETURN IT
TO THE STORE.**

For firearm function issues, contact Beretta:
1-800-237-3882

For light/laser function issues, contact LaserMax:
1-800-527-3703

DANGER

Laser radiation is emitted from the front aperture of the laser when the switch is activated.

WARNING

Avoid direct eye exposure to beam.

REMINDER

Aiming a laser beam at moving vehicles including boats, aircraft, trains, and construction equipment may be illegal. Check current applicable laws and follow them accordingly.

The FDA requires that the label supplied with your laser be affixed to the outside of the gun with the arrow pointing towards the laser aperture.

Do not point laser/light at anything you do not wish to destroy.

LMS-PICO-L

70 Lumen LED

Vision Advisory Claim

RG-2: CAUTION. Do not stare at exposed lamp in operation. May be harmful to the eyes.

LMS-PICO-R

Red Laser

CLASS 3R VISIBLE LASER

Output Power: <5mW

Wavelength: 650nm

**LASER RADIATION
AVOID DIRECT EYE EXPOSURE
CLASS 3R LASER PRODUCT
<5mW
Wavelength: 500—700nm**

Complies with 21CFR1040 per
Laser Notice 50 (2001)



LASERMAX LIMITED WARRANTY

Registration of your product is required in order to receive warranty service.

Go to www.lasermax.com/Service/RegisterWarranty.aspx to fill out the registration form.

The product that you have purchased is subject to the terms of this limited warranty. This limited warranty gives you specific legal rights, and you may also have other rights, which vary from State to State. The product you purchased is warranted to be free from defects in material and workmanship at the time of purchase. This limited warranty does not cover expendable parts (i.e. batteries), because they have definite and predictable life expectancies and should be replaced by you, to protect the product and preserve your warranty. This limited warranty also does not cover damages due to equipment or parts, which upon inspection are determined by LaserMax to have become defective after the date of purchase due to abuse, misuse, etc.

The coverage of this limited warranty begins on the date of purchase and ends 5 years after the date of purchase. This limited warranty is extended only to the original purchaser of the product and is not transferable. To be eligible for warranty coverage you as the original purchaser of the product must register the product in our warranty registration system at www.lasermax.com within 90 days of your original purchase. To make a warranty claim you must make a warranty repair request no later than the date that is five (5) years from the date of purchase and obtain a return authorization number from our Warranty Department at 1-800-527-3703. Once you have made a warranty claim, LaserMax will inspect the product to determine whether it is eligible for warranty coverage.

If eligible, LaserMax will repair or replace the part(s)/product that LaserMax, in its sole discretion, determines to be defective during the warranty period. If not eligible, LaserMax will return the part(s)/product to you and inform you why coverage is not available. LaserMax reserves the right to substitute equivalent product replacement at its discretion.

Any and all implied warranties, including the implied warranties of merchantability, fitness for a particular purpose, and non-infringement also begin on the date of purchase and end 5 years after the date of purchase. Some States do not allow limitations on how long an implied warranty lasts, so the above limitation may not apply to you. The foregoing is your exclusive remedy and LaserMax' exclusive liability for any warranty claim. LaserMax will not, under any circumstances, be liable for any incidental, indirect, consequential, punitive or exemplary damages (even if LaserMax has been notified of the possibility of such damages) resulting from or related to a product including, without limitation, any loss of profits, or loss of opportunity, or damages in excess of your purchase price for the product. Some States do not allow the exclusion or limitation of incidental or consequential damages, so the above limitation or exclusion may not apply to you.



BERETTA

500 YEARS. ONE PASSION.

Beretta USA Corp.
17601 Beretta Drive
Accokeek, MD 20607
Tel. (301) 283-2191
www.beretta.com

UD6A0382