

IMPORTANT! PLEASE READ BEFORE HANDLING YOUR AIR RIFLE

Remington®

AIR RIFLE OWNER'S MANUAL



EXTREMELY IMPORTANT:

DO NOT COCK your airgun until you have read these cautions, the owner's manual, and all other printed material with this airgun. Misuse may void your repair policy, warranty and service contract and may expose you and others to possible harm! A few minutes now will increase the pleasure you will derive from a fine airgun.



DANGER: NOT A TOY - FOR AGES 18 AND OLDER



WARNING

NOT A TOY. SALE RESTRICTED TO ADULTS ONLY. USE RESTRICTED TO ADULTS ONLY. PROOF OF AGE REQUIRED AT TIME OF PURCHASE. SALES PERSONNEL MUST CHECK AGE AT TIME OF SALE. EYE PROTECTION AND MOUTH PROTECTION MUST BE USED AT ALL TIMES WHEN OPERATING THIS NON POWDER GUN. THIS GUN MAYBE LETHAL, AND MAY CAUSE SERIOUS INJURY OR DEATH. MISUSE OR CARELESS USE MAY CAUSE INJURY OR DEATH. MAYBE DANGEROUS UP TO 600 YARDS FOR THE 1000 FPS VERSION.

AIR-GUN PELLET

THIS IS A HIGH POWERED AIRGUN RECOMMENDED ONLY FOR USE BY THOSE 18 YEARS OF AGE OR OLDER. READ ALL INSTRUCTIONS MANUAL BEFORE USING. THE PURCHASER AND USER SHOULD CONFORM TO ALL LAWS OF THE COUNTRY (OR STATE) GOVERNING THE USE AND OWNERSHIP OF AIRGUNS. DO NOT BRANDISH OR DISPLAY THIS AIRGUN IN PUBLIC. IT MAY CONFUSE PEOPLE AND MAY BE A CRIME. POLICE AND OTHERS MAY THINK THIS AIRGUN IS A FIREARM. DO NOT CHANGE THE COLORATION AND MARKINGS TO MAKE IT LOOK MORE LIKE A FIREARM. THAT IS DANGEROUS AND MAYBE A CRIME.

BASIC INFORMATION:

- a. The minimum recommended age of use is 18 years old.
- b. The muzzle velocity is up to 1000 fps.
- c. The maximum distance is 600 yards (549 meters).
- d. The type of projectile intended for use in the gun is for target/small vermin only.
- e. The caliber of projectile intended for use in the gun is .177 (4.5mm).
- f. Always check to see that the gun is unloaded when removed from storage or received from another person.
- g. It is important to use safety glasses when handling or shooting any non-powder guns because of the possibility of injury to the eye(s) associated with the firing of projectiles. Optical reading and, or, or vision glasses may not provide adequate protection; therefore, if you wear glasses, be sure to wear commercial safety glasses over your normal glasses.
- h. Remington Arms Company, LLC and its distributors, dealers, and authorized repair shops can provide you with literature relating to the use and servicing of your gun.
- i. **CAUTION:** your backstop should be inspected for wear before and after each use. Discontinue use if the backstop surface shows signs of failure. Since backstop surfaces eventually fail, always place the backstop in a location that will be safe should the backstop fail. Discontinue the use of a backstop if the projectile rebounds or ricochets.
- j. **CAUTION:** because the trigger pull weight of your gun can be less than three pounds, the gun could fire when dropped.

Dealer: This information manual MUST be given to retail customers with airgun at time of purchase. Shooters are advised to keep this manual, and associated instructions, for future reference by ALL users of this airgun to transfer with airgun if resold or loaned.

⚠ WARNING: BE SURE TO READ THIS MANUAL BEFORE FIRING! THIS AIRGUN IS RECOMMENDED FOR ADULT USE ONLY. PRECISION ADULTS AIRGUNS, BECAUSE OF THEIR DESIGN, ARE A SPECIAL CLASS OF NON-POWDER GUNS. THEY MAY HAVE EXTREMELY SENSITIVE TRIGGER MECHANISMS, VERY LIGHT TRIGGER PULLS, MAY FIRE IF DROPPED OR JARRED ABRUPTLY, AND MAY NOT HAVE A TRIGGER BLOCK OR "SAFETY". THIS SPECIAL CLASS OF AIRGUNS IS INTENDED FOR USE BY EXPERIENCED ADULT SHOOTERS WHO UNDERSTAND THEIR PROPER & SAFE USE. AIRGUNS ARE NOT TOYS.

⚠ WARNING: NOT A TOY. THIS AIRGUN IS RECOMMENDED FOR ADULT USE ONLY. MISUSE OR CARELESS USE MAY RESULT IN SERIOUS INJURY OR DEATH. DANGEROUS WITHIN 600 YARDS (549 METERS).

⚠ WARNING: USE OF INCORRECT PROJECTILES MAY NOT BE SAFE.

⚠ WARNING: PELLETS SHOULD NOT BE REUSED.

⚠ WARNING: MODIFICATION OF THE GUN MECHANISM MAY CAUSE A GUN TO MALFUNCTION AND TAMPERING WITH A GUN MAY MAKE IT UNSAFE TO USE.

⚠ WARNING: DO NOT BRANDISH OR DISPLAY THIS AIRGUN IN PUBLIC – IT MAY CONFUSE PEOPLE AND MAY BE A CRIME. POLICE AND OTHERS MAY THINK THIS AIRGUN IS A FIREARM. DO NOT CHANGE THE COLOURATION AND MARKINGS TO MAKE IT LOOK LIKE A FIREARM. THAT IS DANGEROUS AND MAY BE A CRIME.

⚠ WARNING: ANY CHANGE IN PERFORMANCE, SUCH AS LOWERED TRIGGER FORCE AND SHORTENED TRIGGER TRAVEL, INDICATES POSSIBLE WEAR; HAVE YOUR GUN INSPECTED TO DETERMINE WHETHER IT SHOULD BE PROPERLY REPAIRED OR REPLACED.

⚠ WARNING: REPAIRS SHOULD ONLY BE MADE BY QUALIFIED PERSONNEL.

⚠ WARNING: CHECK ANY GUN THAT HAS BEEN DROPPED TO ENSURE THAT ITS FUNCTION HAS NOT BEEN AFFECTED.



DANGER

Determine if your airgun has anything in its barrel.

The muzzle end of any airgun is dangerous. Never depend on any safety. All safeties are mechanical devices and therefore subject to failure. Your airgun should be locked up when not in use. Always keep the muzzle pointed in a safe direction.

Be sure your airgun is unloaded when: crossing a fence, stream, or other barrier, letting go of it for any reason, putting it away; or allowing another person to handle it; entering a house, vehicle. The only way to be sure that your airgun is not loaded is to look through the bore or pass an object all the way through the bore. A projectile or obstruction could be present anywhere in the bore. If your airgun is a barrell-cocking airgun, simply open the barrel slightly and look down the bore from the rear. **YOU MUST BE ABLE TO SEE ALL THE WAY THROUGH THE BORE TO CONSIDER IT CLEAR.** If your airgun has a fixed breech block arrangement (other than tap loader) that makes it difficult to look down the barrel directly from the rear, you should use a small mirror or pass a cleaning rod, that will not harm the bore, all the way through to determine if it is clear.

You should have a proper cleaning rod for the above safety checks and to insure best accuracy. A cleaning rod may also be used to clear a projectile or other obstruction out of the barrel. Never fire a projectile to clear a barrel! Such an action will only make the problem worse and may be dangerous.

NOT RECOMMENDED

We do NOT recommend the use of steel darts in any rifle bore. Also not recommended: plastic sheathed steel or zinc pellets. Their hard cores can cause dangerous ricochet and penetration through immediate effect. Their lightness and lack of air resistance may cause excessive piston impact inside the airgun.

“SLAM SHUT” DAMAGE NOT COVERED

NOTE: DO NOT snap a barrel cocking airgun's barrel shut excessively hard or allow it to fly up from an open position. This can cause an upward bent barrel, a cracked or broken stock and a bent cocking lever. This combination of damage always represent abuse and is not covered by any warranty, repair policy, or service contract! Snapping such airguns shut may also cause a discharge. Always point every airgun in a safe direction!

STATEMENT OF NON-LIABILITY

Airguns can cause serious harm, and in some instances, even death and should be handled with great care! This airgun is manufactured and sold by Remington with the express understanding that we assume no liability for its resale, handling, use or possession under local laws or regulations. Personal injury or property damage resulting from either intentional or accidental discharge or for airgun functions subjected to influences beyond our control, are the sole responsibility of the airgun owner. We will honor no claims that may result from careless handling, unauthorized adjustments, defective or improper ammunition, corrosion or neglect.

By accepting the airgun, the buyer agrees to release the seller and Remington, and all associated persons from liability for any damage to persons or property that may result, for any reason, by using this airgun. Safety is your responsibility.

The Remington EXPRESS break barrel air rifle is very easy to operate, extremely consistent, and can provide trouble free use if the following instructions are adhered to. A few minutes spent reading this manual are essential to safe operation and will increase the many years of pleasure you will derive from this fine airgun.

BASIC NOMENCLATURE: A typical "barrel-cocking" air rifle is shown here; other types are illustrated on the next pages and basic internal parts are shown on page 9.

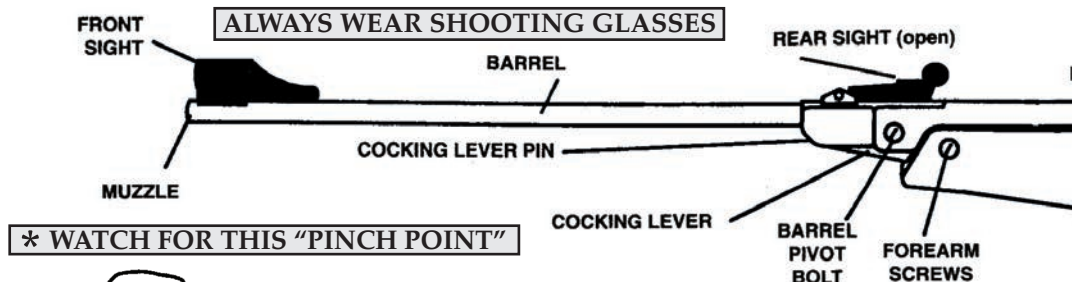

*** WATCH FOR THIS "PINCH POINT"**

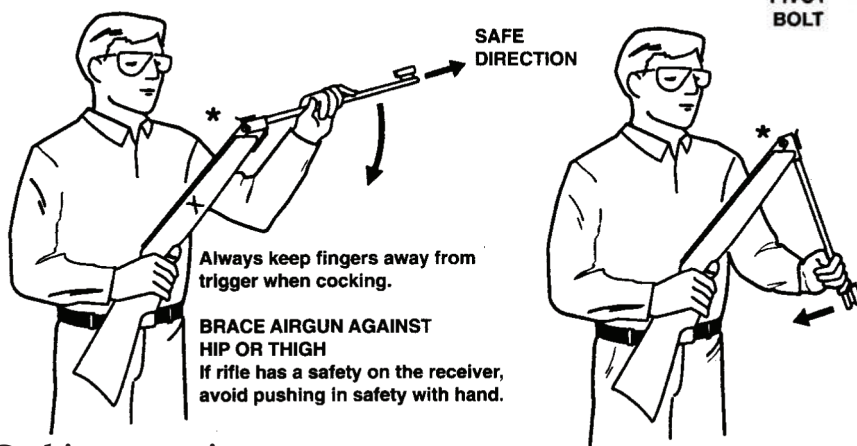

Cocking your airgun

Your airgun is powered by a powerful spring in the receiver. Grasp the airgun by the **pistol grip** or middle of the forearm (point marked "X" above) with your right hand (if you are right-handed).

Avoid trigger!

1. For barrel-cocking airguns: with the airgun pointed upwards, smartly give a slap to the **barrel** as far forward as convenient. This will start the barrel downward to "break" open the action. You will quickly learn how to do this easily. It's a simple "knack."
2. Now, **WITHOUT TOUCHING THE TRIGGER OR SAFETY**, pull the **barrel** fully down, completing the cocking action. You will feel it and when the piston clicks into the cocking

position.

If there is an automatic safety, be sure that it pops into the "SAFE" position! Do not pull past this point and never use excessive force or speed. Many airguns have a built-in device that disconnects the action of the trigger when the barrel is in this down and cocked position, some do not.

PROPER USE OF SAFETY

After cocking the airgun, an automatic safety bar will move out of the action. Push the safety button firmly in all the way to disengage the safety. You will immediately be in the firing mode. This model carries a safety reset lever, see diagram.



WARNING! Pulling the trigger of an airgun when the barrel is not held back and is in the downward cocked position will result in the barrel snapping up with great force, causing damage to the airgun, (bent barrel, broken lever and broken or cracked stock) and injury to the shooter. This is considered abuse and not covered by any warranty, repair policy, and/or service contract.



WARNING! the airguns described here are designated as Match Precision or Adult Airguns and, as such, are exempt from having as "safety", may have trigger pulls below 2 lbs. (900 gms) and may fire when dropped.

These features reflect the more sophisticated requirements of precision adult airgun shooting. These special cases of non-powder guns are intended for use by experienced adult shooters who understand their proper and safe use.



WARNING: KEEP YOUR HANDS, and other objects, AWAY FROM THE TRIGGER AND SAFETY during all cocking and loading procedures!

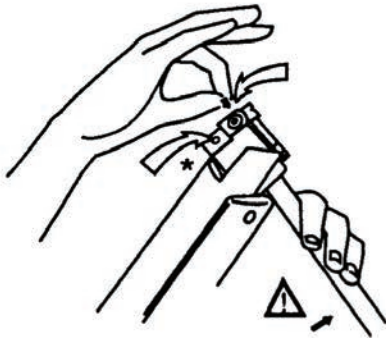
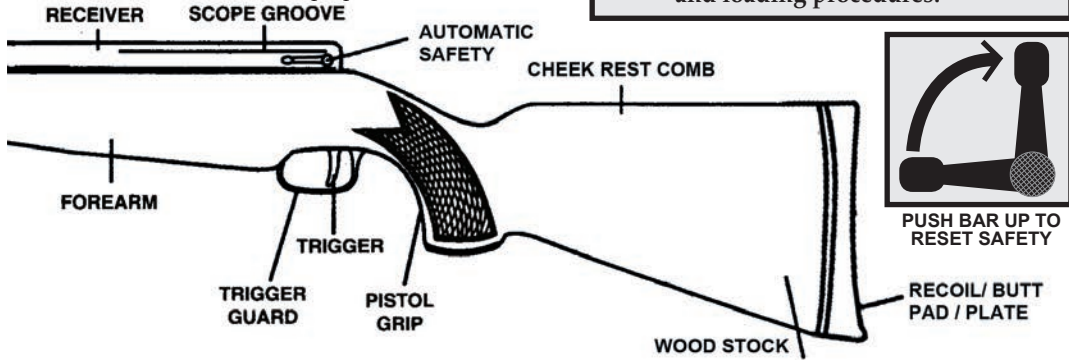

*** WATCH FOR THIS "PINCH POINT"**

Loading the Airgun

With the barrel in down or open position, while firmly restraining the barrel with your other hand, push a pellet into the breech, closed end first, until the skirt is flush with the face of the breech. If skirt is not flush, it will be deformed when the airgun is closed resulting in an inaccurate shot. Check for this by opening the airgun a little after loading and checking for pellet damage. Don't push the pellet in with the edge of your fingernail. Do not use damaged pellets, pellets that have been fired before, darts or unauthorized projectiles. These can be unsafe and damage your airgun.

Closing the Airgun

Close the airgun by moving the barrel up until it "clicks" into position. Do this smoothly but not violently (slamming it shut may cause a discharge or damage to the airgun). Your airgun is now ready to shoot. (The safety will have to be released on models with automatic safeties).

BE SURE THE AIRGUN IS ALWAYS POINTING AWAY FROM ANY PERSON OR ANY PART OF YOU!

SPECIAL CAUTIONS!

THE GOLDEN RULE OF AIRGUN HANDLING:
See that the muzzle is ALWAYS pointed in a safe direction!

SPECIAL CAUTIONS!

Precision adult airguns, because of their design, are a special class of non-powder guns and may have a trigger pull below 2 lbs., may fire if dropped, and may not have a trigger block or "safety". These features reflect the more sophisticated needs of precision adult airgun shooting. Such airguns are often carefully designated to have sensitive trigger mechanisms and trigger pulls which are much lighter than regular airguns. This special class of airguns is intended for use by experienced adult shooters who understand their proper and safe use. All shooters and bystanders should always wear protective glasses during firing.

COCK CAREFULLY

The cocking mechanism of many spring piston airguns may close suddenly if released accidentally; this may injure the shooter, bystanders, and damage the airgun. Avoid excessive cocking force. Cock smoothly and go easy near the end of the cocking stroke. **DO NOT** snap the airgun shut!

AVOID TRIGGER WHEN BREECH IS OPEN

Breech may close suddenly if trigger is tripped!

TREAT ALL AIRGUNS AS IF LOADED

Follow safe airgun handling practices. Remember that airguns can be dangerous if mishandled.

NEVER DEPEND ON ANY "SAFETY"

A safety is just a mechanical device and, therefore, could be subject to failure. There is no substitute for safe airgun handling.

DO NOT LEAVE AIRGUN COCKED OR LOADED

Avoid leaving the mainspring or spring-piston airguns under full compression for extended periods. It is best to cock just before firing. Always check every airgun to see if it is loaded every time you handle it. Always assume your airgun is loaded.

USE PROPER PELLETS

Use only high-quality pellets to avoid harmful oils, abrasive material, and air blow-by. Precision adult airguns are intended for use only with lead pellets; steel shot or darts damage air rifle bores and may cause dangerous ricochet or rebound. Properly seated pellets should not show rub marks on rear of skirt if breech is reopened prior to firing. Damaged, used or unauthorized projectiles may be unsafe.

USE ONLY SPECIFIC LUBRICANTS

Mineral oils should be used for the external metal surfaces. Not internally (barrel / action) as this may cause excessive dieseling. Internally, silicone oil is recommended. **DO NOT OVER LUBRICATE!**

STORE YOUR AIRGUN IN A SAFE AND PROPER MANNER, SECURE FROM UNAUTHORIZED USE!

WARNING

Airguns are not toys. Misuse or careless use may cause serious injury or death.
THIS AIRGUN IS DESIGNATED FOR USE BY EXPERIENCED ADULT SHOOTERS AND IS INTENDED FOR MATCH COMPETITION OR TARGET RANGE USE. CARELESS USE MAY RESULT IN SERIOUS INJURY OR DEATH.

SPECIAL NOTE: On all cocking types avoid excessive force in opening or shutting airgun!

ALWAYS keep all airguns pointed in a SAFE DIRECTION AT ALL TIMES

DO NOT ATTEMPT TO UNCOCK YOUR AIRGUN! If you have cocked your air rifle, loaded a pellet and decided not to take the shot in a reasonable amount of time, do not leave your airgun cocked.

- A. If already loaded: Removing the pellet is inadvisable and doing this with a sharp object could seriously damage the delicate rifling. The best course of action is to shoot the airgun into soft ground, a pellet trap or thick pile of newspapers or magazines.
- B. If unloaded: **BE SURE AIRGUN IS UNLOADED.** * Then put muzzle tightly against firm, soft pad (such as padded rug - but NEVER against part of your body), to provide air resistance, and discharge airgun. Try not to do this often. A better way is to load a pellet and discharge the airgun safely in the regular way.

**Always check an airgun to see if it is loaded when removed from storage or received from another person. The ONLY ways to be sure that your barrel is unloaded is to look through the bore from the rear or pass a cleaning rod through the bore from the rear.*

Shooting your airgun safely

First, a word of warning:
NEVER SHOOT A SPRING PISTON AIRGUN WITHOUT A PELLET!

To do so permits the piston to slam hard against the front of the compression chamber. Repeated "dry firing" can definitely damage your airgun. It needs the cushioning action of the air compressing behind a properly fitting pellet to work correctly. Also, for this reason, you should not shoot damaged or previously fired pellets. Steel BB's and darts, low quality or irregular pellets can damage your airgun and should not be used. Any other unauthorized projectiles are definitely not recommended.

Shoot your airgun shortly after cocking and loading. It is not advisable to leave the airgun cocked for extended periods of time.

Always be sure of your back stop. Be sure that the entire path of your pellet, even beyond the target, is safe! Do not shoot at glass or hard surfaces. Avoid ricochets. It is impossible to predict where a glancing shot will fall. Remember a pellet may travel up to about 600 yards (549 meters).



Shooting glasses are a must for all airgun shooters and spectators.

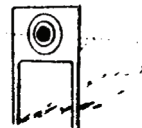

CAUTION: Inspect back stop for wear before and after each use. Discontinue if surface shows signs of failure if projectiles rebound or ricochet severely. Since many backstop surfaces eventually fail, always place a backstop in a location that will be safe.

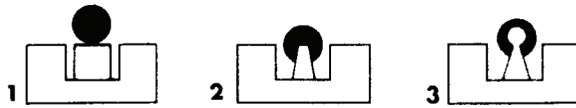

Sight Picture

What you see when you are aiming at a target is called the "Sight Picture." For accurate shooting this relationship of sights and target must be correct and above all consistent from shot to shot.

The open sight: The front sight is usually either a post or a post with a "bead". The open rear sight is usually attached just in front of the breech. It has a "U" or "V" notch. Some airguns give you an assortment of rear notches. There are three correct sight pictures.

1 the "6 o' clock" hold is best for target shooting since it gives a clear cut reference point. The post is centered in the rear notch with the top of the posts level with the top of the notch.

Maintaining this relationship, place the post just under the "bullseye" so that the bullseye appears to be sitting right on top of, or above the post. The sights are adjusted so the pellets strike above this point in the center of the target.

2 The "point of aim" hold is considered the best for field use. The relationship of front and rear sights are set so pellets strike exactly where the sights point at the distance the airgun is "sighted in."

3 If your air rifle has a "bead" front sight, this is the correct sight picture. With a bead front, the "Point of Aim" hold is best.



Aperture Sight

Some air rifles are equipped with an aperture sight (also known as receiver, peep, or diopter sight). It may be purchased as an option for some air rifles. This is a very easy sight to use and it is far more accurate and faster than an open sight because there is less guess work in its use and the distance between front and rear sight ("sight span") is much greater. To use an aperture sight, just look through the aperture or "peep", find the front sight, and put the front sight on the target. When looking through the receiver sight try to

ignore the aperture, do not try to "center" the front sight. The human eye cannot focus on three objects so far apart. The eye will automatically seek the strongest source of light coming through the aperture and this automatically centers the front sight. If you should install an aperture sight on an air rifle that has an open sight already on it, remove the rear sight after lining up the receiver sight with it (Aperture sights are not suitable for air pistols). NOTE: Most air rifles will require a barrel angle correction before installing an aperture sight.

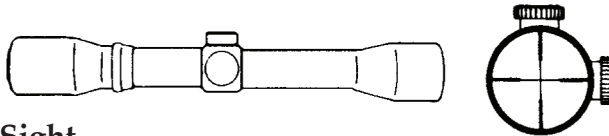

Telescopic Sight

This is the simplest and fastest to use of all since it has magnification and only one plane of focus. Also many scopes actually gather light or allow shooting when it would be too dark for iron sights. Put the crosshairs on your target and shoot. Adjust as per scope instructions. NOTE: Be sure that the scope that you put on your airgun is designed specifically for airgun use.

Most scope for firearms are parallax adjusted to 50 meters, where as airgun scopes are parallax adjusted to 10 meters. The scope must be factory adjusted for correct airgun range or have a properly set adjustable "Range Focus" dial at the front end of the scope tube or you will shoot inaccurately, as much as half-inch off at 25 yards (12mm at 23m).

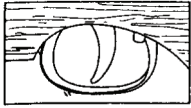

The Trigger

The majority of adult spring piston airguns have what is known as a "two stage"

trigger. The first "stage" is merely a predetermined amount of take-up or slack preparatory to the last or "second stage" which is the let-off or actual firing stage. This is a European custom and is designed to aid the shooter to embrace and steady for the discharge of the rifle.

The trigger pull setting as it comes from the manufacturer is usually the best for the airgun in question and should not be lightened. A good trigger pull for an adult airgun is about 3-6 pounds (1300-2700 gms).

For a match grade adult target airgun about 1.5 oz. (500 gms) to 2 lbs. (900 gms) is generally recommended. Most match airguns have the pull set at the manufacturer for the minimum International Shooting Union weight (500 gms).

Trigger technique: Assume a normal standing or rest position, take a correct sight picture.

Now take a normal breath, hold it, and then squeeze the trigger. Do not jerk or slap the trigger. There is no substitute for practice. Happily, with an adult airgun practice is easy and inexpensive. For details, consult a recommended book on match shooting techniques.



WARNING! Modifications and/or tampering with a trigger mechanism may cause an airgun to malfunction and become unsafe to use. Any change in the performance such as lowered trigger force and shortened trigger travel indicates possible wear and such airguns should be inspected, replaced or properly repaired. The trigger may be adjustable below 2 lbs., (900 gms) and if adjusted below 2lbs., the airgun could fire even more easily when dropped. Check any airgun that has been dropped to make sure its function has not been affected. Repairs should only be made by technicians. Such special qualified persons are the **ONLY** ones who should make any adjustments which are not externally available on the fully assembled airgun.



CAUTION: do not use oils or solvents intended for firearms or other devices in the compression chamber of any spring piston airgun! to do so can cause severe detonation or "dieseling effect," resulting in possible damage to airgun and injury to the shooter and/or bystanders.

Only special lubricants specifically designed for spring piston airgun compression chambers should be used. These are sophisticated silicone oils specially formulated for the purpose. Of the hundreds of silicone oils available, only a few have the proper flash point, viscosity, lubricity, lack of acids, etc., for use in the fine quality spring piston airguns. Incorrect lubes can be dangerous. **The reason for this** is that during the firing cycle of a spring piston airgun compressed to quite high pressures, resulting in high temperatures for a fraction of a second. This heat can actually explode any vaporized flammable oils in the chamber. Very light dieseling is often experienced with a new airgun that has not been "broken-in". The manufacturer oils and lubricants can cause minor dieseling. The airgun may make a loud "crack" and give off some smoke. Usually this stops after a few dozen shots and the airgun settles down to its normal pressures. Sometimes it may take a tin or two of pellets before the excess lubricants are cleared. A wisp of mist or smoke after shooting is not cause for alarm and is a sign that your airgun is getting some vapor lubrication into the barrel, a good thing.

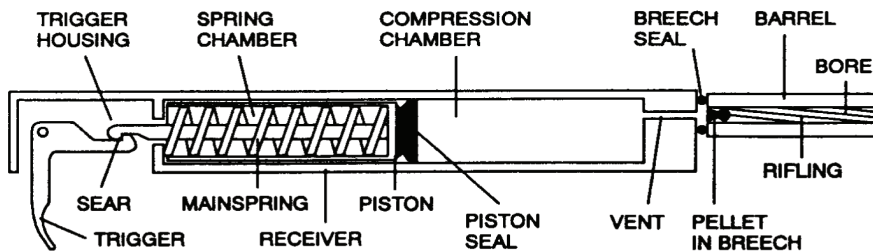

Typical Spring Piston Mechanism

Note: This diagram has been simplified for clarity, the airgun is shown in the cocked position. In a Gas spring airgun the "mainspring" consists of a sealed unit of compressed gas.

Troubleshooting

NOTE: Spring piston adult airguns have characteristics which are unique. Most “problems” encountered by new owners are often really not problems at all or are easily corrected. In any case, most experts agree that the spring piston system is the most trouble free of all airguns power mechanisms.

PROBLEM: POOR ACCURACY/Possible Causes:

1. Dirty bore. Most accuracy complaints are traced to an unclean bore. Even a barrel which appears to be clean may be shooting well below its potential. Look up the bore from the breech (directly or with a small mirror). If you don't see shiny clean rifling the bore is dirty. **SOLUTION:** Felt cleaning pellets are ideal for this purpose - and are easy and fast to use. (See bore cleaning in the basic points section overleaf.)

2. Not Using Special Shooting Techniques. Because of the relatively long time that pellets remain in the airgun after the trigger is pulled, as compared to bullets in a firearm, airguns are much more sensitive to shooter motion. This is one of the reasons why airguns are so good for teaching technique to firearm shooters. Many excellent firearm marksmen do NOT do well with airguns until they have improved techniques that were not so critical with firearms. Published accuracy figures were obtained by AIRGUN experts under ideal conditions. Imperfect techniques, especially some techniques which are excellent for firearms, may cause oversized groups. **SOLUTION:** Give yourself time to become accustomed to each airgun. Do not rest barrel on anything while shooting. Using sandbags or firearms bench rest methods often will give you very poor accuracy with airguns. Use loose consistent pressure and replace airgun to same, position for each shot.

3. Minor dieseling often occurs in new airguns. This is the burning off of manufacturing oils and greases. The airgun “cracks” and shots go high or wild due to higher velocity. **SOLUTION:** This problem usually solves itself after a few shots. Some airguns may require 500 to 1,000 pellets or even internal “super tune-up”, to be completely “cured”. Over lubrication, or improper lubrication, is a very common cause of this and several other airguns problems.

4. Loose stock screws. This is a major cause of inaccuracy in airguns new or old. One quarter of a turn may affect accuracy by 2 inches (50mm). **SOLUTION:** Tighten front and rear screws very firmly. If problem recurs, remove screws, degrease screws and screw holes thoroughly and apply Loc-Tite 242 sealant.

5. Incorrect or defective pellets: Keep in mind that each air rifle is unique and it requires some experimentation on your part to find just exactly the types of pellets that will work best for each of your particular airguns. Damaged pellets will not shoot well and may damage the airgun.

6. Breech seal leak. The breech seal may be defective, worn from use or damaged due to dieseling. **TEST:** Cock and load the airgun. Hold the palm of your hand about 1/2" (15mm) above the joint between the breech and receiver. Be very careful not to let this hand touch the airgun. If there is a seal leak you will feel a strong blast of air, a slight leak is normal blowoff of excess pressure in many models. **SOLUTION:** Replace seal. A severe leak can cause a piston to slam into the end of the chamber with eventual piston, spring and chamber damage. (Don't disturb even an ugly, blemished seal if it works well!)

7. Improper pellet seating. Correctly seated pellets have the pellet skirt flush with, or below, the face of the breech. In top loading airguns, the pellets often drop a short distance into the barrel or top - this is correct. Improper pellet seating may cause the pellet skirt to become smashed when breech is closed. **SOLUTION:** Seat pellets deep enough, carefully and consistently. Using a Pellet Seat will provide consistency and increase potential accuracy and power by smoothing the skirt.

8. Bent or weakened mainspring. Mainsprings can assume a “set”, become bent, or even break. Metal fatigue can cause a spring to lose some of its elasticity. Years of use or leaving your airgun cocked overnight can cause low velocities. If an airgun becomes hard to cock or velocity decreases this is a good indication of a broken and/or weakened mainspring. **SOLUTION:** Have mainspring replaced by a technician.



WARNING!
ONLY TECHNICIANS SHOULD
REPAIR THESE GUNS. AIRGUN
SPRINGS ARE UNDER TENSION EVEN
WHEN UNCOCKED AND CAN CAUSE
PERSONAL INJURY WHEN IMPROPERLY
HANDLED.

9. Loose sight. Front and/or rear sight screws or scope mount screws can work loose. **SOLUTION:** Tighten all sight and scope mount screws firmly with correctly fitting gunsmith screwdrivers. If problem continues, remove sights or scope mount and degrease all mating surfaces thoroughly three times, apply film of Loc-Tite 242 (Use standard, not industrial Loc-Tite 242) to sight/airgun contact points and reinstall, tightening screws well.

**PROBLEM: AIRGUN DOES NOT SHOOT/
Possible Causes:**

1. Shooter Error. Shooter may not be cocking airgun to full cock. **SOLUTION:** Bring barrel (or cocking lever) all the way back until it stops and gradually increase pressure until a final "click" is felt. **DO NOT** force.

2. Broken mainspring. CAUTION: Repairing airguns should only be attempted by a technician. Personal injury and/or airgun damage is possible if this is incorrectly done. **NOTE:** Repairs and /or enhancements performed by a non-technician will void your warranty, service contract and /or repair policy!

3. Safety in "on" position. Always check safety before firing trigger. Some airguns have an automatic safety, in others the safety may have been manually engaged. **SOLUTION:** Put safety in "fire" position manually. Always point airgun in safe direction before releasing energy.

**PROBLEM: ACCIDENTAL DISCHARGE/
Possible Causes:**

1. Airgun not fully cocked. Due to hasty cocking. **SOLUTION:** Be sure to cock deliberately. Excessive

force is never necessary.

2. Trigger setting too light. This a dangerous situation. Most commonly due to owner over "improving" trigger pull. **SOLUTION:** Increase trigger pull weight setting.

**PROBLEM: PELLET FIT VERY TIGHT/
Possible Causes:**

Some airguns are engineered with a tight breech for maximum performance. Such airguns depend on the pellet holding still, like a cork, until the air pressure reaches a critical peak.

**PROBLEM: STOCK BREAKS OR CRACKS/
Possible Causes:**

This is always caused by dropping the airgun or allowing the barrel to snap shut to itself (This also causes cocking levers and barrels to bend!) This is not covered by repair policy, warranty or service contract.

Due to variations, between the country of origin and final area where stock is used, minor drying cracks (called checks) may appear. They are superficial blemishes and almost never enlarge. All new airguns have some small blemishes; those selected for stock condition have fewer such blemishes, but no stock is perfect.

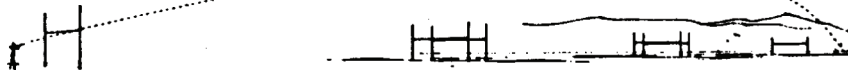

WARNING! the airguns described here are designated as Match Precision or Adult Airguns and, as such, are exempt from having a "safety" may have trigger pulls below 2 lbs. (900 gms) and may fire when dropped.

Important Safety Tips In addition to the instructions and cautions on the preceding pages, we would like to include a few basic tips for your safe shooting practices. Some points are important enough to repeat!

- **Normal operating temperature of piston airguns is approximately 20° to 110°F (-6° to 42°C).**
- **Always check to see if the airgun is loaded** when removed from storage or received from another person! A pellet may be in the bore without being easily visible! See clearing bore instructions. Never fire, even unloaded, airguns against any part of your body.
- **Never allow anyone, especially youth, to use an airgun loaded or unloaded until they are fully trained in airgun safety and proper use!**
- **Treat all airguns as if loaded.** Follow safe airgun handling practices. Remember that airguns can be dangerous if mishandled. Precision adult airguns are not toys; they can cause serious injury or even death. For proper training and information contact your local airgun clubs and/or the National Rifle Association.
- **Adjustments and repairs** should be made only by technicians. Never use a malfunctioning airgun!
- **Store the airgun in safe and proper place,** secure from unauthorized use. Locking it up is best.
- **Shoot safely:** Airgun pellets may travel up to 600 yards (549 meters). Be sure of your backstop. Avoid ricochets. Do not shoot at hard surfaces. Shooters and bystanders should always wear shooting glasses during firing. **NEVER** depend on a "safety".

Which Pellets To Use?

The all important ingredient to airgun shooting success:

You need several different kinds.

Airgun pellets, just like firearm ammunition, are available in a great variety of weights and shapes to suit particular shooting needs. The following will help you select the type of pellets that will work best for you. Keep in mind that each air rifle and air pistol is an individual and it requires some experimentation on your part to find just exactly the types of pellets that will work best for each of your particular airguns.

The quality of the pellets that you shoot in your airguns will determine the success you have on the target range or in the field. It is essential to shoot only

high quality pellets in spring-piston airguns. Low quality or deformed pellets not only result in poor accuracy but can actually damage these airguns by allowing compressed air to blow by the pellet and cause the piston to slam harshly against the forward end of the compression chamber.

Always use proper pellets. Use only high quality pellets to avoid harmful oils, abrasive material and airgun wrenching air blow-by. Precision adult airguns are intended for use only with precision airgun pellets; steel shot or darts are not recommended and generally damage rifled bores and may cause dangerous ricochet or rebound. Properly seated pellets should not show rub marks on rear of skirt when breech is reopened prior to firing. Damaged, used, or unauthorized projectiles may be unsafe.

BASIC POINTS:

The **COMPRESSION CHAMBER** is that portion of the receiver where the actual air compression takes place when the piston moves forward in shooting, since the air is heated to as high as 2,000°F for a fraction of a second upon firing, excessive lubrication will cause dieseling (detonation) that can possibly damage the airgun and injure the shooter. Lubrication should be performed by technicians during regular service intervals.

MAINSPRINGS are the storehouses of the energy the shooter provides by cocking the airgun, and need to expand smoothly with as little friction and vibration as possible. The mainspring is housed in the spring cylinder, which is a polished cylinder containing the piston, the mainspring, and the spring guide shaft. All metal mainsprings eventually have some cant; therefore, the polish and lubrication of all surfaces here is critical for maximum performance. Recoilless airguns receiving extensive use in competition should be serviced once a year by technicians.

COCKING LEVER LINKAGES receive considerable pressure; proper lubrication insures smooth operation and minimum wear. Moly is also useful in such areas as the sliding parts.

BARREL PIVOT POINTS and detents benefit from lubrication. Remember, do not over lube, and keep low flash point oils away from air vent and breech seal.

TRIGGER MECHANISMS in spring-piston airguns vary from the simple two moving parts of economy models to the beautifully engineered complexity of Feinwerkbau. Do not attempt to lubricate triggers on the sophisticated recoilless airguns. Triggers and sears on less expensive rifles and pistols benefit from very sparing application of Metal-2-Metal paste.

Front and rear **STOCK SCREWS** must be firmly tightened and checked before each use of your air rifle. If loosening occurs, remove stock screws, degrease stock screws and stock screw holes thoroughly; then sparingly apply Loc-Tite 242 (blue) sealant, and tighten firmly.











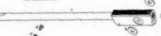







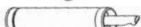







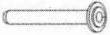







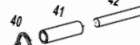











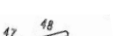

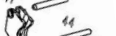





BORE CLEANING. Since airguns do not use powder or primers, cleaning is not necessary to prevent most rust; however, it is essential to good accuracy. Use MP-5 oil. Accuracy suffers badly due to caked grease residues blown into the bore from the compression chamber and from leading. Most accuracy complaints are the result of dirty bores—even though they may look clean! For storage, clean the bore and leave it with a light coating of MP-5 polarizing oil 9205. After cleaning with MP-5 oil (do NOT use regular firearm bore cleaners as they will damage seals and cause dieseling), follow with dry patches until no trace of oil is seen. A few regular pellets will have to be shot through a cleaned barrel before it can be expected to return to its "zero".

EXTERIOR SURFACE should be regularly wiped with a silicone cloth 9400 to maintain the quality of the finish. Before airguns are stored, they should be given a good wiping with a very high-grade polarizing oil such as MP-5.

USE PROPER PELLETS! Use only high quality pellets to avoid harmful oils, abrasive material and airgun barrel damage. Precision adult airguns are intended for use only with lead pellets. Steel shot or darts damage air rifle bores. Properly seated pellets should not show rub marks on rear of skirt if breech is reopened prior to firing. Damaged, used or unauthorized projectiles may cause dangerous ricochet, excessive piston impact and excessive penetration.

ACCURACY TESTING. The accuracy of the airgun will only become constant once barrel and cylinder are fully bedded in. This usually takes approximately 1000 - 1500 shots, this applies to open sights or being used with telescopic sights. High consistent accuracy can only be achieved if the rifle is correctly zeroed in with an appropriate scope and mount system and shot from a bench rested position.

PART LIST

1		Barrel Complete	29		Round head pin
2		Screw M4	30		Adjusting spring
3		Front Sight	31		Screw M4
4		Sight base	32		Piston seal
5		Rear sight complete	33		Piston
6		Screw M4/2	34		Tube
7		Elevation Knob	35		Main spring
8		Hinge washer/2	36		Spring guide washer
9		Breech seal	37		Spring guide
10		Joint screw	38		Trigger Housing
11		Bushing	39		Sear
12		Joint Nut	40		Torsion spring
13		"E" ring	41		Hollow shaft
14		Lever pin	42		Long Horizontal pin
15		Lever Complete	43		Short Horizontal pin
16		Screw M5/2	44		Hook piece fixed pin /2
17		Toothed spring washers/2	45		Hook
18		Stock	46		Torsion spring
19		Trigger guard	47		Trigger
20		Trigger guard screw	48		Trigger pin/2
21		Half countersunk head screw	49		Spring pin
22		Stock recoil plate	50		Square nuts
23		Wood screw/2	51		Support plate
24		Compression tube complete	52		Mobile piece
25		Safety spring	53		Spring washer
26		Safety shaft	54		Screw M5
27		Safety Lever	55		Gravity spring
28		Safety shaft cap	56		Adjusting screws

SPARE PART DIAGRAM

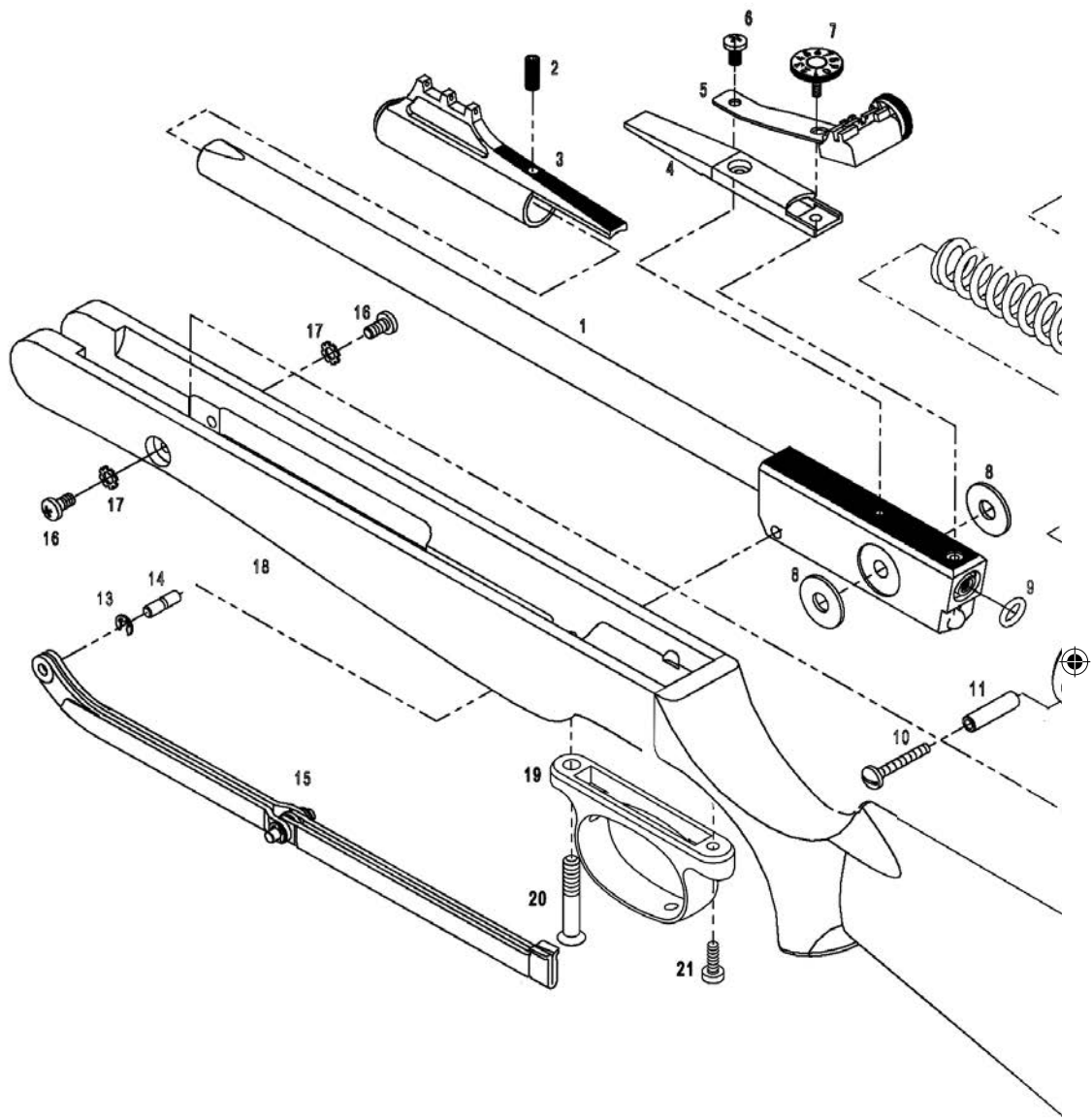

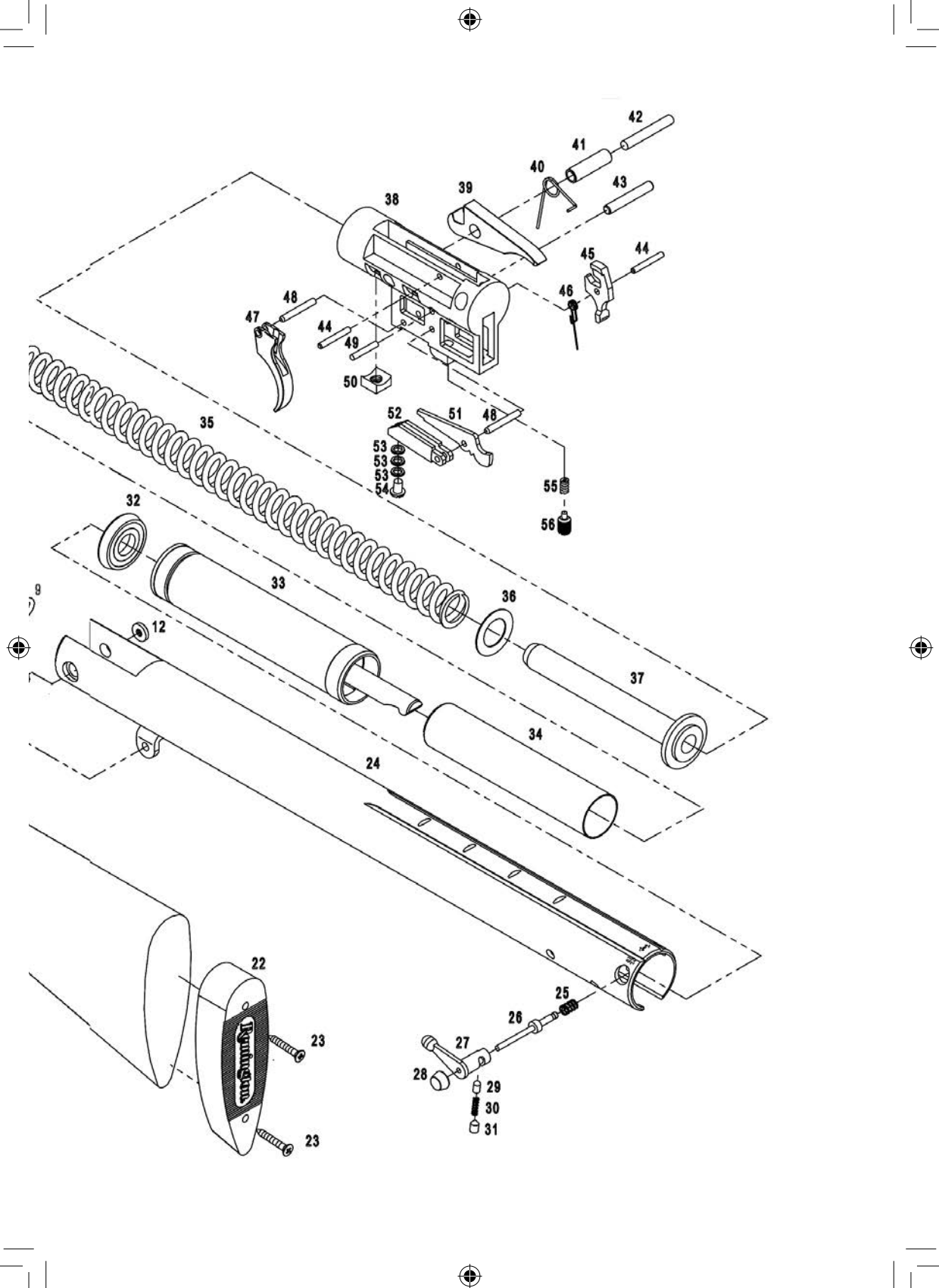

SPECIAL TERMINOLOGY

ENGLISH

Horizontal Sight Adjustment
Vertical Sight Adjustment
Joint washer
Loading Lever
Fixing Screw
Barrel Fixing Plunger

AMERICAN

Windage Adjustment
Elevation Adjustment
Breech Seal
Cocking Arm
Lock Screw
Detent



ONE YEAR WARRANTY FOR AIR RIFLE

Remington Arms Company, LLC ("RAC") warrants to the original purchaser ("OP") of a new air rifle from RAC that such air rifle shall be free from defects in material and workmanship for one year from the date of original purchase by the OP. RAC, in its sole discretion, shall repair or replace the air rifle if the OP, subject to the instructions in this warranty, submits a claim to remedy a defect in the material or workmanship of the air rifle. If RAC opts to replace the air rifle, RAC will keep the air rifle that it replaces. The OP's remedies under this warranty are limited to repair or replacement of the air rifle; RAC will not provide cash, credit, or refund. RAC does not warrant against any type of defect to the air rifle that RAC did not cause, including but not limited to:

1. Failure to provide proper care and maintenance,
2. Accidents, abuse or misuse,
3. Barrel obstruction,
4. Improper ammunition,
5. Unauthorized adjustments, repairs or modifications, or
6. Normal wear and tear.

Additionally, RAC EXCLUDES AND WILL NOT PAY INCIDENTAL OR CONSEQUENTIAL DAMAGES UNDER THIS WARRANTY. INCIDENTAL OR CONSEQUENTIAL DAMAGE MEANS ANY LOSS, EXPENSE, OR OTHER DAMAGE THAT CANNOT BE REMEDIED BY EITHER REPAIRING ANY DEFECT IN THE AIR RIFLE OR BY REPLACING THE AIR RIFLE. RAC EXPRESSLY EXCLUDES IMPLIED WARRANTIES; THERE ARE NO WARRANTIES WHICH EXTEND BEYOND THE DESCRIPTION ON THE FACE HEREOF THAT RELATE TO MERCHANTABILITY, FITNESS, OR OTHERWISE. Furthermore, no individual or entity other than RAC possesses the authority to alter the obligations, limitations, disclaimers, or exclusions under this warranty or any other RAC warranty. The OP, in order to achieve eligibility under this warranty, must complete and submit the warranty registration card within thirty (30) days of purchase. The OP, upon discovering a defect in material or workmanship in the air rifle, shall contact RAC at:

Remington Arms Company, LLC
870 Remington Drive, P.O. BOX 700, Madison, North Carolina 27025.
Telephone: 1-800-243-9700
Fax: 336-548-7801

RAC, upon receiving the OP's correspondence or phone call, shall provide instructions to the OP governing the manner in which to return the air rifle for repair or replacement. The OP must submit a copy of its sales receipt for the air rifle when returning the air rifle. In the unlikely event that this Remington Express Break Barrel Air rifle needs to be returned to Remington for service/repair, the owner must prepay freight. We will not accept COD shipments. Remington does not accept responsibility for any damage or delay occurring during transit.

THIS IS THE WARRANTY CERTIFICATE

This rifle has a one year unlimited warranty against all production defects. However the warranty will become void if used inappropriately, has been modified or dismantled. In the unlikely event your air rifle should develop a fault the first action should be to contact your Airgun retailer. In the unlikely event that this Remington Express Break Barrel Air rifle needs to be returned to Remington for service/repair, the owner must prepay freight. We will not accept COD shipments. Remington does not accept responsibility for any damage or delay occurring during transit.

PLEASE RETURN THIS WARRANTY CARD TO:

Remington Arms Company, LLC
870 Remington Drive, P.O BOX 700, Madison, North Carolina 27025.
Telephone: 1-800-243-9700
Fax: 336-548-7801

NAME :

DATE OF BIRTH :

ADDRESS :

TELEPHONE :

EMAIL ADDRESS :

MODEL :

CALIBER :

SERIAL NUMBER :

DATE OF PURCHASE :

STAMP OF YOUR RETAILER / COPY OF THE RECEIPT

[Empty rectangular box for retailer stamp or receipt copy]







**Warning and Danger Notices
On Covers and Inside!
Be a safe shooter!
Safety is Your responsibility!**

The Golden Rule of Safe Airgun Handling:
**Always see that the airgun is pointed in a safe
direction! Treat all airguns as if loaded!**



WARNING! MAY FIRE IF DROPPED. As an Adult Airgun it is exempt from drop test requirements. It may fire if dropped or hit sharply, even if the safety is in the "ON" position. Do not lean or place your airgun where it may fall, and be careful not to impact any part of the loaded airgun.

Remington[®]

Remington Arms Company, LLC
870 Remington Drive, P.O. Box 700, Madison, NC 27025-0700
www.remington.com