



# Smith & Wesson®

## Safety & Instruction Manual

---

### SW1911 Pistols & SW1911 E-Series™ Pistols

---



**Read the instructions and  
warnings in this manual  
CAREFULLY BEFORE  
using this firearm.**

2100 Roosevelt Avenue • Springfield, MA 01104  
1-800-331-0852 • Fax: 413-747-3317  
[www.smith-wesson.com](http://www.smith-wesson.com)

Copyright © 2018 Smith & Wesson Corp.  
All rights reserved.



# **WARNING** **READ THESE**



**INSTRUCTIONS AND WARNINGS CAREFULLY. BE SURE YOU UNDERSTAND THESE INSTRUCTIONS AND WARNINGS BEFORE USING THIS FIREARM. FAILURE TO READ THESE INSTRUCTIONS AND TO FOLLOW THESE WARNINGS MAY RESULT IN SERIOUS INJURY OR DEATH TO YOU AND OTHERS AND DAMAGE TO PROPERTY.**

**This SAFETY & INSTRUCTION MANUAL should always accompany this firearm and be transferred with it upon change of ownership or when presented to another person. A copy of the SAFETY & INSTRUCTION MANUAL is available FREE via download at [www.smith-wesson.com](http://www.smith-wesson.com) or upon request from:**

**SMITH & WESSON®  
CUSTOMER SUPPORT CENTER  
2100 ROOSEVELT AVENUE  
SPRINGFIELD, MA 01104  
TEL.: 1-800-331-0852, ext. 4125  
E-mail: [qa@smith-wesson.com](mailto:qa@smith-wesson.com)**

## TABLE OF CONTENTS

YOUR SAFETY RESPONSIBILITIES .....	3-6
SAFE STORAGE AND TRANSPORTATION.....	7-8
AMMUNITION .....	9-11
MODEL AND FEATURES IDENTIFICATION.....	12
INSPECTING YOUR PISTOL .....	13-15
LOADED CHAMBER INDICATOR.....	16
PREPARATION FOR FIRING .....	17
LOADING.....	18-20
FIRING .....	21
DECOCKING.....	22
CLEARING MISFIRES.....	23
UNLOADING.....	24
REAR SIGHT ADJUSTMENT .....	25
FIELD STRIPPING / DISASSEMBLY .....	25-30
FIELD STRIPPING / ASSEMBLY .....	31-35
LUBRICATION .....	35
MAGAZINE .....	36
CLEANING AND MAINTENANCE .....	37-39
LIMITED WARRANTY .....	40-41
CONTACT AND SHIPPING INFORMATION .....	42-43
BATTERY WARNINGS .....	44
CUSTOM SERVICE.....	46
PATENTS AND INTERNATIONAL WARRANTY CNTRS .....	47

---

# YOUR SAFETY RESPONSIBILITIES

---

## SAFETY IS YOUR NUMBER ONE RESPONSIBILITY!!!!

- At home, in the field, at the range, or anywhere, the first concern of every firearm owner should be safety. Apply the following safety rules in every situation, with any kind of firearm. If you feel uncertain about any operational aspects of your firearm, please contact Smith & Wesson at 1-800-331-0852, ext. 4125 before proceeding with its operation.
- If you are unfamiliar with firearms you should seek formal training before using your pistol.



**WARNING: YOU MUST FOLLOW ALL OF THESE SAFETY RULES TO ENSURE THE SAFE USE OF YOUR FIREARM. THE FAILURE TO FOLLOW THE INSTRUCTIONS AND WARNINGS IN THIS MANUAL COULD CAUSE SERIOUS PERSONAL INJURY OR DEATH TO YOU OR OTHERS AND DAMAGE TO PROPERTY.**

- As a firearm owner, you accept a demanding responsibility. How seriously you take this responsibility can be the difference between life and death. There is no excuse for careless or abusive handling of your firearm. At all times handle your firearm with intense respect for its power and potential danger.

---

## YOUR SAFETY RESPONSIBILITIES CONTINUED

---

- **ALWAYS KEEP YOUR FIREARM POINTED IN A SAFE DIRECTION.** Never point a firearm at anyone or anything you do not intend to shoot whether or not it is loaded. This is particularly important when loading, unloading, or field stripping the gun. ALWAYS control the direction of the firearm.
- **ALWAYS TREAT EVERY FIREARM AS IF IT IS LOADED AND WILL FIRE.** Do not take anyone's word that the firearm is unloaded – always check for yourself. Never pass your firearm to another person until the cylinder or action is open and you visually check that it is unloaded. If possible, the safety should be engaged as well. Keep your firearm unloaded and safely stored when not in use.
- **NEVER PLACE YOUR FINGER INSIDE THE TRIGGER GUARD OR ON THE TRIGGER UNLESS YOU INTEND TO FIRE.** Ensure that other objects do not touch the trigger.
- **ALWAYS BE SURE OF YOUR TARGET AND WHAT IS BEYOND IT.** Always be sure of where the bullet will strike and shoot only where there is a safe back stop free of obstructions, water or other surfaces which can cause ricochets. Be sure your bullet will stop behind your target. Bullets can glance off many surfaces like rocks or the surface of water and travel in unpredictable directions with considerable velocity. Do not fire randomly into the sky.
- **NEVER CROSS OBSTACLES SUCH AS FENCES OR STREAMS WITH A LOADED FIREARM.** Always make certain your firearm is unloaded before crossing a fence, climbing a tree, jumping a ditch or negotiating other obstacles.
- **SAFE GUN HANDLING IS YOUR PERSONAL RESPONSIBILITY AT ALL TIMES.** Firearms can be dangerous and can cause serious injury or death if they are misused or used inappropriately. Safety must be the prime consideration of any one who owns or handles firearms. Accidents are the result of violating the rules of safe gun handling and common sense. Firearm safety training is available. Contact your firearms dealer, law enforcement agency, local sportsman's club, the NRA, etc. for availability.
- **YOU ARE RESPONSIBLE FOR THE FIREARM AT ALL TIMES.** In owning a firearm, you must undertake full-time responsibility for your firearm's safety and security. You must protect yourself and all others against injury or death from misuse of the firearm 24 hours a day.
- **FIREARM SECURITY IS YOUR RESPONSIBILITY.** You must secure firearms safely from children and/or unauthorized users. Your firearm should always be kept unloaded and locked when not in use. A lock has been provided for this purpose. Never assume that the use of a lock is sufficient to safely secure your firearm. You must always evaluate your personal situation and employ the security systems that meet your needs and prevent children and unauthorized users from gaining access to your firearm.

---

## YOUR SAFETY RESPONSIBILITIES CONTINUED

---

- **APPROPRIATE USE FOR YOUR FIREARM MEANS USING YOUR FIREARM FOR LEGAL PURPOSES.** For example - target shooting, hunting and lawful resistance of deadly criminal force. It is your responsibility to ensure that you are in compliance with all applicable laws and ordinances regarding the use of your firearm.
- **NEVER RELY ON MECHANICAL FEATURES ALONE.** Only your safe gun-handling habits will ensure the safe use of your firearm. This is your responsibility.
- **ALWAYS SAFELY STORE AND SECURE YOUR FIREARM.** Safe and secure storage of your firearm is one of your most important responsibilities. It is a full-time responsibility. You must always secure your firearm and ammunition separately so that they are not accessible to children and/or other unauthorized persons.
- **NEVER KEEP AMMUNITION IN THE SAME LOCATION AS THE FIREARM.** Store each in a separate and secure place.
- **ALWAYS WEAR EYE PROTECTION THAT IS SPECIFIED FOR USE WITH FIREARMS** every time you handle your firearm for cleaning and maintenance.
- **ALWAYS WEAR EYE AND HEARING PROTECTION THAT IS SPECIFIED FOR USE WITH FIREARMS** every time you discharge your firearm. Make sure others in the vicinity of where you will be shooting do so as well.
- **NEVER USE ALCOHOL OR DRUGS BEFORE OR WHILE SHOOTING.** Do not use your firearm if you are on any medication which impairs, even slightly, your mental or physical ability.
- **ALWAYS HAVE ADEQUATE VENTILATION.** Discharging firearms in poorly ventilated areas, cleaning firearms, or handling ammunition may result in exposure to lead and other substances known to cause birth defects, reproductive harm, and other serious physical injury. Review the warnings and labels for all ammunition and cleaning products carefully. Wash hands thoroughly after exposure.
- **BEFORE HANDLING ANY FIREARM, UNDERSTAND ITS OPERATION.** Not all firearms are the same. Familiarize yourself with the mechanical features of any firearm you intend to use. If you feel uncertain about any operational aspects of your firearm, please contact Smith & Wesson at 1-800-331-0852, ext. 4125 before proceeding with its operation.
- **NEVER ALLOW A FIREARM TO BE USED BY INDIVIDUALS WHO DO NOT UNDERSTAND ITS SAFE OPERATION OR HAVE NOT READ THESE FIREARM SAFETY RULES.**

---

## YOUR SAFETY RESPONSIBILITIES CONTINUED

---

- **ALWAYS USE THE CORRECT AMMUNITION FOR YOUR PARTICULAR FIREARM** as indicated by the marking on the barrel. Never use non-standard, reloaded, or “handloaded” ammunition which has not been subjected to internal ballistic pressure testing.
- **BEWARE OF BARREL OBSTRUCTIONS** Be sure the barrel is clear of obstructions before shooting. Mud, water, snow or other objects may inadvertently lodge in the barrel bore. A small obstruction can cause a dangerous increase in pressure and may damage your gun and cause injury to yourself and others.
- **BE SURE ALL ACCESSORIES, SUCH AS HOLSTERS, GRIPS, SLINGS, SCOPES AND OTHER ACCESSORIES ARE COMPATIBLE** with the firearm and that the accessories do not interfere with safe operation. It is your responsibility to understand and follow all of the instructions in this manual, as well as those which may be supplied with your ammunition and any accessory.
- **NEVER DISASSEMBLE YOUR FIREARM** beyond the field stripping procedure outlined in this manual. Improper disassembly or reassembly of your firearm may be dangerous and can lead to serious injury or death.
- **NEVER MANIPULATE, ADJUST OR CHANGE ANY OF THE INTERNAL COMPONENTS OF YOUR FIREARM UNLESS SPECIFICALLY INSTRUCTED TO DO SO IN THIS MANUAL.** Improper manipulation of any other internal component may affect the safety and reliability of your firearm and may cause serious injury or death.
- **NEVER ALLOW ANY ALTERATION OR REPLACEMENT OF PARTS IN YOUR SMITH & WESSON FIREARM UNLESS PERFORMED BY A QUALIFIED GUNSMITH** using genuine Smith & Wesson parts. If you do otherwise, improper functioning of your firearm may occur and serious injury or death and damage to property may result.



**WARNING: SAFE USE OF A FIREARM IS YOUR PERSONAL RESPONSIBILITY AND THE FAILURE TO FOLLOW ALL OF THESE BASIC SAFETY RULES MAY RESULT IN SEVERE PERSONAL INJURY OR DEATH TO YOU OR OTHERS AND DAMAGE TO PROPERTY. YOU ARE THE MOST IMPORTANT SAFETY DEVICE WHEN IT COMES TO THE USE OF YOUR FIREARM AND SMITH & WESSON WILL NOT BE RESPONSIBLE FOR ANY PERSONAL INJURY, DEATH OR PROPERTY DAMAGE THAT RESULTS FROM:**

**(1) THE CRIMINAL OR NEGLIGENT USE OF THIS FIREARM; (2) A DISREGARD OF THESE SAFETY INSTRUCTIONS AND WARNINGS; (3) IMPROPER OR CARELESS HANDLING OF THIS FIREARM; (4) THE USE OF NON-STANDARD, DEFECTIVE, IMPROPER AMMUNITION; OR (5) IMPROPER OR NEGLIGENT MODIFICATIONS OR REPAIRS TO THE FIREARM.**

---

# SAFE STORAGE AND TRANSPORTATION

---



**WARNING: ALWAYS POINT THE MUZZLE IN A SAFE DIRECTION.**



**WARNING: FIREARMS ARE DANGEROUS WHEN USED AND STORED IMPROPERLY. THEY POSE A RISK OF SERIOUS OR FATAL INJURIES. FIREARMS CAN BE ESPECIALLY DANGEROUS TO CHILDREN WHEN THEY ARE STORED IN AN IRRESPONSIBLE AND UNSAFE MANNER. FOR YOUR SAFETY AND THE SAFETY OF OTHERS, IT IS IMPERATIVE THAT YOU KEEP YOUR FIREARM UNLOADED AND LOCKED IN A SECURE PLACE. THE AMMUNITION SHOULD BE STORED IN A SEPARATE, SECURE LOCATION WHEN IT IS NOT IN USE. SAFE AND SECURE STORAGE OF YOUR FIREARM IS ONE OF THE MOST IMPORTANT RULES OF FIREARM SAFETY. YOUR FAILURE TO FOLLOW THESE RULES MAY RESULT IN SERIOUS INJURY OR DEATH TO YOU OR OTHERS.**

- **ALWAYS SECURE YOUR FIREARM IN A MANNER THAT WILL PREVENT UNAUTHORIZED ACCESS.** Whenever your firearm is not in use, keep it unloaded and locked. Your safety and the safety of others requires that you always secure and store your firearm in a manner that will prevent unauthorized access. Never leave a firearm unattended unless it is unloaded locked and secured.
- **ALWAYS USE THE LOCK PROVIDED BY SMITH & WESSON TO SECURE YOUR FIREARM.** Please read and follow the instructions packaged separately for the use of this lock. A lock, when properly used, can be an effective tool in preventing unauthorized access to your firearm. There are other alternative locks and safe storage containers available in the marketplace which may also be appropriate for your particular needs. Consult your local gun shop, hardware store, or local police department for guidance on the variety of other safe storage devices or practices which may be appropriate for your particular needs. By purchasing this firearm you have accepted the responsibility of safely securing the firearm at all times and preventing its unauthorized use. Never assume that the use of this lock alone is sufficient to safely secure your firearm. It is your personal responsibility to select and use whatever measures or practices that will enable you to be absolutely certain that your firearm is secure at all times.



**WARNING: NEVER LOCK A LOADED FIREARM AND NEVER LOAD A LOCKED FIREARM!**

---

## SAFE STORAGE AND TRANSPORTATION CONTINUED

---

- **ALWAYS STORE YOUR FIREARM AND AMMUNITION SEPARATELY** so that they are not accessible to children or other unauthorized persons. Safe and secure storage of your firearm and ammunition are your responsibility. It is a full-time responsibility.
- **NEVER ASSUME THAT A “HIDING” PLACE IS A SECURE STORAGE METHOD.** Others may be aware of your storage location or come upon it by chance. It is your personal responsibility to use common sense when storing your firearm and ammunition and to always make sure they are not accessible to children or other unauthorized persons.
- **NEVER TRANSPORT A LOADED FIREARM.** When transporting your firearm, be sure it is unloaded and locked. Safe and secure transportation of your firearm is your responsibility.
- **ALWAYS FOLLOW THE LAW!** Many jurisdictions have laws that make it a crime to keep a firearm unlocked and in an area accessible to children or others. Keeping a firearm unloaded and locked when not in use is not only common sense safety practice... IT IS THE LAW. You must be familiar with all local, state, and federal laws regarding the safe storage and transportation of your firearm. Failure to know and follow the law may result in unauthorized access or use of your firearm by another. Obey all laws relating to the storage and transportation of firearms. Your local police department or gun shop can furnish you with available information on storing and/or transporting a firearm safely and legally.
- **YOUR FIREARM IS YOUR RESPONSIBILITY.** You must prevent your firearm from being stolen or from being used by untrained or unqualified individuals. Keep it unloaded, locked and secured when not in use.



# AMMUNITION



**WARNING: NEVER USE AMMUNITION NOT SPECIFICALLY DESIGNATED FOR USE IN YOUR FIREARM. FAILURE TO USE THE CORRECT TYPE OR CALIBER OF AMMUNITION MAY CAUSE THE FIREARM TO JAM, FAIL TO FIRE OR EVEN GENERATE EXCESSIVE PRESSURE WHICH CAN DAMAGE OR EVEN RUPTURE YOUR FIREARM, CAUSING PERSONAL INJURY, DEATH OR PROPERTY DAMAGE.**

- Locate the cartridge designation marked on the firearm. This information indicates the correct ammunition that must be used in this firearm (FIGURE 1).



- You are responsible for selecting ammunition that meets industry standards and is appropriate in type and caliber for this firearm.
- Never use a cartridge not specifically designated for use in your firearm. The wrong type of ammunition may exceed the capability of your firearm and may damage or even rupture your firearm.
- Never mix ammunition.



**WARNING: IN SOME CASES, A ROUND OF AMMUNITION NOT SPECIFIED ON YOUR FIREARM AND NOT LISTED AS ALTERNATE AMMUNITION IN THIS MANUAL, MAY FIT INTO THE CHAMBER. FIRING THIS AMMUNITION MAY CAUSE A RUPTURE RESULTING IN DAMAGE TO THE FIREARM AND PERSONAL INJURY OR DEATH TO THE SHOOTER OR BYSTANDERS. FOR MORE INFORMATION REGARDING UNSAFE CALIBER COMBINATIONS, REFER TO THE FOLLOWING URL: [HTTP://WWW.SAAMI.ORG/SPECIFICATIONS\\_AND\\_INFORMATION/PUBLICATIONS/DOWNLOAD/SAAMI\\_ITEM\\_211-UNSAFE\\_ARMS\\_AND\\_AMMUNITION\\_COMBINATIONS.PDF](http://www.saami.org/specifications_and_information/publications/download/saami_item_211-unsafe_arms_and_ammunition_combinations.pdf)**



**WARNING: ALWAYS INSPECT YOUR AMMUNITION BEFORE USING IT. NEVER USE DIRTY, CORRODED OR DAMAGED AMMUNITION. A BURST CARTRIDGE MAY RESULT CAUSING DAMAGE TO THE FIREARM AND PERSONAL INJURY OR DEATH TO THE SHOOTER OR BYSTANDERS.**

- Use only commercially manufactured ammunition with internal ballistic pressures which are in strict accordance with the specifications of the Sporting Arms and Ammunition Manufacturers' Institute (SAAMI). If you are uncertain, contact your ammunition supplier for verification.

---

## AMMUNITION CONTINUED

---



**WARNING: NEVER USE NON-STANDARD, RELOADED OR “HANDLOADED” AMMUNITION WHICH HAS NOT BEEN SUBJECTED TO INTERNAL BALLISTIC PRESSURE TESTING. RELOADED OR HANDLOADED AMMUNITION, MAY HAVE MANY MANUFACTURING AND QUALITY VARIABLES (SUCH AS THE TYPE AND AMOUNT OF GUN POWDER). CARTRIDGE CASES THAT HAVE BEEN RELOADED AND FIRED MULTIPLE TIMES MAY SUFFER PHYSICAL DAMAGE WHICH COULD SIGNIFICANTLY IMPACT OR REDUCE THE INTEGRITY OF THE CARTRIDGE, POSSIBLY RESULTING IN BULLET SETBACK OR UNSEATING. CASE FAILURE AND INJURY TO THE SHOOTER OR BYSTANDERS AND DAMAGE TO THE FIREARM MAY RESULT WHEN SUCH A ROUND IS FIRED. ANY AMMUNITION THAT IS IMPROPERLY MANUFACTURED OR RELOADED, EVEN IN THE SLIGHTEST DEGREE, MAY FAIL TO FIRE OR MAY GENERATE EXCESSIVE INTERNAL PRESSURES WHICH CAN DAMAGE OR EVEN RUPTURE THE FIREARM, CAUSING PERSONAL INJURY OR DEATH TO THE SHOOTER OR THOSE IN THE IMMEDIATE VICINITY.**

- A firearm and ammunition are a system and must work together. There are different types of ammunition for different types of firearms. Your firearm has been designed for ammunition of a specific type and a specific gauge or caliber. It is important to select the proper ammunition for your firearm.
- Different combinations of bullet velocity, bullet weight and firearm weight can have major impact on felt recoil; high felt recoil can be uncomfortable to some shooters.

For example:

- Firearm Weight: lower firearm weight increases felt recoil.
- Bullet Weight: higher bullet weight increases felt recoil.
- Bullet Velocity: higher bullet velocity increases felt recoil.

To acclimate yourself to higher levels of felt recoil, consider the following:

- Use a firm two-hand hold on the grip when firing.
- Always start your shooting experience with the lowest bullet velocity and lowest bullet weight available for your firearm.
- Ask your firearm dealer to suggest the lowest power, lowest velocity, lightest bullet weight for your firearm.



**WARNING: DISCHARGING FIREARMS IN POORLY VENTILATED AREAS, CLEANING FIREARMS, OR HANDLING AMMUNITION MAY RESULT IN EXPOSURE TO LEAD AND OTHER SUBSTANCES KNOWN TO CAUSE BIRTH DEFECTS, REPRODUCTIVE HARM, AND OTHER SERIOUS PHYSICAL INJURY. HAVE ADEQUATE VENTILATION AT ALL TIMES. WASH HANDS THOROUGHLY AFTER EXPOSURE.**

## AMMUNITION CONTINUED

 **WARNING: NEVER USE AMMUNITION OF THE INCORRECT GAUGE OR CALIBER. USING AMMUNITION OF THE INCORRECT GAUGE OR CALIBER MAY CAUSE DAMAGE TO YOUR FIREARM AND POSSIBLE SERIOUS INJURY TO YOU AND TO OTHERS.**

 **WARNING: NEVER USE CARTRIDGES OTHER THAN THOSE DESIGNATED BY THE MARKING ON THE FIREARM. DOING SO CAN RESULT IN DANGEROUSLY HIGH PRESSURES THAT MAY DAMAGE THE FIREARM AND POSSIBLY CAUSE SERIOUS INJURY TO YOURSELF AND OTHERS.**

 **WARNING: DEATH, SERIOUS INJURY AND PROPERTY DAMAGE CAN RESULT FROM THE USE OF INCORRECT AMMUNITION OR BORE OBSTRUCTIONS. NEVER USE RELOADED AMMUNITION THAT HAS NOT BEEN SUBJECTED TO INTERNAL BALLISTIC PRESSURE TESTING. SEE PAGE 10 FOR DETAILS.**

- “Plus-P” (+P) ammunition generates pressures in excess of the pressures associated with standard ammunition. Such pressures may affect the wear characteristics and may result in the need for more frequent service.
- “Plus-P-Plus” (+P+) ammunition must not be used in Smith & Wesson firearms. This marking on the ammunition designates that it exceeds established industry standards, but the designation does not represent defined pressure limits and therefore such ammunition may vary significantly as to the pressures generated and could be DANGEROUS.

Marking on Firearm	Ammunition Type		
	Standard	+P	+P+
380 AUTO	OK	NO	NO
9mm	OK	OK	NO
9x21mm	OK	NO	NO
38 Super	OK	OK	NO
357 SIG	OK	NO	NO
40 S&W	OK	NO	NO
45 AUTO	OK	OK	NO

- Some brands of ammunition may cause difficulty in extracting spent cartridge cases from the chamber. If this situation occurs, thoroughly clean the chamber with solvent. If this condition persists, we recommend changing to another brand of ammunition.

# MODEL AND FEATURES IDENTIFICATION

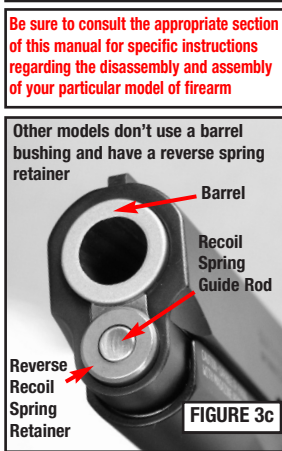
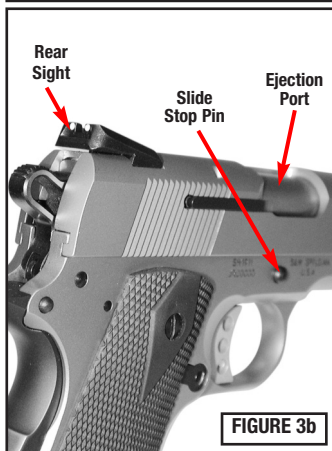
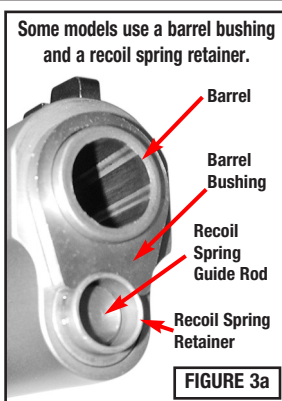
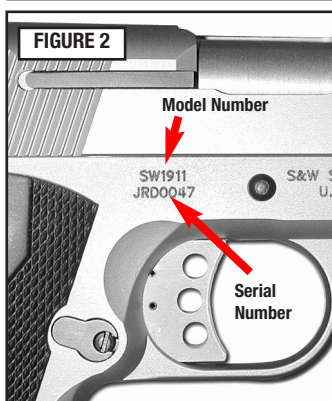

# INSPECTING YOUR PISTOL



**WARNING: ALWAYS ENSURE THAT THE FIREARM IS UNLOADED BEFORE INSPECTING, DISASSEMBLING, ASSEMBLING OR CLEANING AND ALWAYS KEEP THE MUZZLE POINTED IN A SAFE DIRECTION.**

- When you inspect your pistol, you should first check for yourself to ensure that it is unloaded. To do this, grasp the pistol with your finger off the trigger and outside the trigger guard.

- Point the muzzle in a safe direction and depress the magazine release and remove the magazine (FIGURE 4).

- If the hammer is not cocked and the safety is down in the “fire” position, the slide can be drawn to the rear.



**WARNING: ALWAYS KEEP YOUR PISTOL POINTED IN A SAFE DIRECTION. ALWAYS KEEP YOUR FINGER OFF THE TRIGGER AND OUTSIDE THE TRIGGER GUARD.**

- If the hammer is cocked and the safety is up in the “safe” position, depress the safety lever into the fully down “fire” position (FIGURE 5) to allow the slide to be drawn to the rear.

- Point the muzzle in a safe direction, grasp the serrated sides of the slide from the rear with the thumb and fingers as shown in FIGURE 6a, and briskly draw the slide fully rearward in order to extract any cartridge from the barrel chamber and clear it from the pistol. Do not obstruct the ejection port because doing so can interfere with ejection of a cartridge.

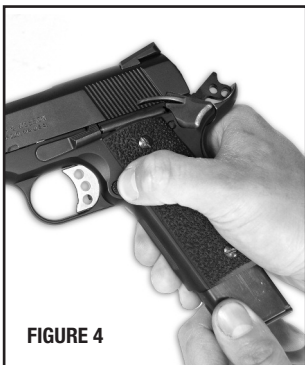

FIGURE 4

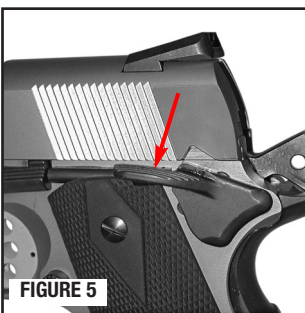

FIGURE 5

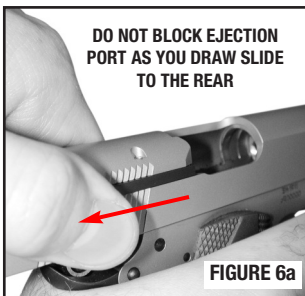

FIGURE 6a

## INSPECTING YOUR PISTOL CONTINUED

- Lock the slide in the open position by allowing the slide to move slightly forward from the rearmost position while pressing the slide stop upward (FIGURE 6b).
- Check the barrel chamber and bore visually for any live rounds or obstructions. Clear any live round or obstruction before proceeding.



- Examine the breech face (FIGURES 7a and 7b) to ensure that the firing pin is not protruding from the breech face.

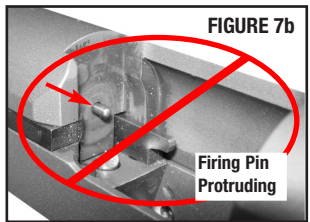
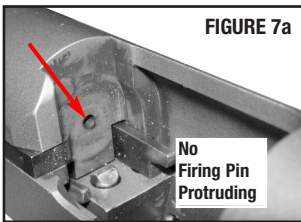

**WARNING: VERIFY THAT THE FIRING PIN IS NOT PROTRUDING FROM THE BREECH FACE. IF THE FIRING PIN IS PROTRUDING, MAKE SURE THE FIREARM IS POINTED IN A SAFE DIRECTION, UNLOAD THE FIREARM AND HAVE IT INSPECTED AND TEST FIRED BY A GUNSMITH QUALIFIED TO PERFORM SERVICE ON SMITH & WESSON FIREARMS.**

- You must follow this procedure every time your firearm leaves your hand, is cleaned, handed to you or another person, transported or stored.
- Unload the magazine by holding it with the bullet end of the cartridge pointing away from you and pressing each cartridge forward and out of the magazine.
- Familiarize yourself with the safety lever on your pistol. When the safety lever is fully down as shown (FIGURE 8) notice that there is NO engagement between safety lever and safety engagement notch. This is the "Fire" position.

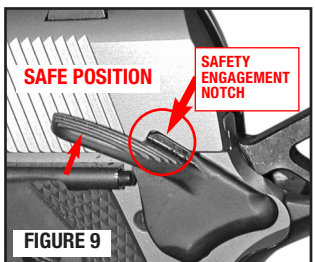
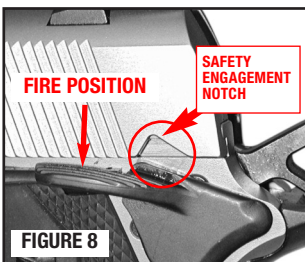

---

## INSPECTING YOUR PISTOL CONTINUED

---

- When the hammer is fully cocked and the safety lever is fully up, and has FULL engagement of the safety engagement notch, it is in the "Safe" position (FIGURE 9).
- When it is in the "Safe" position, the slide is also locked in place and cannot be moved rearward. Notice how the safety lever looks and feels in each of the two positions of its extreme travel - fully up for "Safe" and fully down for "Fire".



**WARNING: IT SHOULD BE NOTED THAT WITH THE HAMMER IN THE AT REST (FULLY FORWARD) POSITION, THAT THE SAFETY LEVER CAN BE PRESSED UP SLIGHTLY. NEVER CONFUSE THIS WITH THE FULLY UP "SAFE" POSITION AS THE SAFETY HAS NOT BEEN ENGAGED.**

- There are three hammer positions on your SW1911 and SW1911 E-Series™ pistol: AT REST (fully forward), fully cocked (fully rearward), and half cocked position.

**AT REST (FULLY FORWARD)** position is when the face of the hammer is resting on the firing pin.

**HALF-COCKED POSITION** of the hammer functions as an automatic safety position. It will prevent the hammer from falling fully forward unintentionally. Never attempt to fire the pistol from the half-cocked position. To remove the hammer from the half-cocked position, keep your finger off the trigger and out of the trigger guard, then draw the hammer to the fully-cocked position. From this position, the pistol may be fired or decocked. The half-cocked position is not a manual safety. The hammer should never be left in this position. Never carry the pistol in the half-cocked position.

**FULLY COCKED (FULLY REARWARD)** is when the hammer is pulled to the second click point. This is the fire position.



**WARNING: TO PLACE THE SAFETY IN THE FULLY UP "SAFE" POSITION, THE SLIDE MUST BE FORWARD AND THE HAMMER MUST BE IN THE FULLY COCKED POSITION. ATTEMPTING TO PLACE THE SAFETY IN THE UP POSITION WHILE THE HAMMER IS NOT FULLY COCKED WILL ALLOW ONLY PARTIAL MOVEMENT OF THE LEVER AND WILL NOT ENGAGE THE SAFETY. FAILURE TO FOLLOW THIS WARNING MAY RESULT IN SERIOUS INJURY OR DEATH TO YOU OR OTHERS.**



**WARNING: NEVER RELY ON MECHANICAL FEATURES ALONE. ONLY YOUR SAFE GUN HANDLING WILL ENSURE THE SAFE USE OF YOUR FIREARM. THIS IS YOUR RESPONSIBILITY.**

- Before using your firearm for the first time, it should be cleaned.

# LOADED CHAMBER INDICATOR



**WARNING: NEVER RELY UPON THE LOADED CHAMBER INDICATOR ALONE TO VERIFY THE PRESENCE OR ABSENCE OF A ROUND IN THE CHAMBER. THE SUREST METHOD TO DETERMINE THE PRESENCE OR ABSENCE OF A ROUND IN THE CHAMBER IS TO VISUALLY CHECK THE CHAMBER OF YOUR FIREARM BY PULLING AND LOCKING THE SLIDE TO THE REAR.**

- SW1911 and SW1911 E-Series™ pistols come with a loaded chamber indicator. This indicator can be observed at the top of the slide/ejection port by observing an opening at the rear of the barrel hood (FIGURE 10). By looking into this opening, you can observe whether or not a round is in the firearm's chamber. If a round is in the chamber, you should see the cartridge rim through this opening. Never rely on the loaded chamber indicator alone to verify the presence or absence of a round in the chamber. The proper method to verify the presence of a round in the chamber is to follow the directions in the "Inspecting Your Pistol" section of this manual.

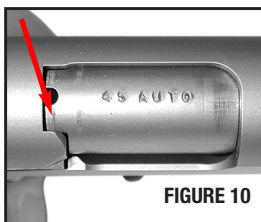

**WARNING: ALWAYS TREAT EVERY FIREARM AS IF IT IS LOADED AND WILL FIRE IF THE TRIGGER IS PULLED. A LOADED CHAMBER INDICATOR MAY HELP DETERMINE WHETHER THE CHAMBER IS LOADED OR UNLOADED. THE AMOUNT OF LIGHT, CLEANLINESS OF THE PISTOL, DISCOLORATION OF THE AMMUNITION AND OTHER FACTORS MAY LIMIT THE EFFECTIVENESS OF THE LOADED CHAMBER INDICATOR.**



---

# PREPARATION FOR FIRING

---



**WARNING: THE FAILURE TO FOLLOW THESE FIREARM SAFETY REQUIREMENTS WILL CAUSE SERIOUS PERSONAL INJURY OR DEATH TO YOU OR OTHERS.**

- **ALWAYS TREAT ALL FIREARMS AS IF THEY ARE LOADED.**
- **ALWAYS BE SURE THAT THE CHAMBER IS CLEAR OF A CARTRIDGE, THE MAGAZINE IS REMOVED OR UNLOADED, AND THAT THE FIREARM IS POINTING IN A SAFE DIRECTION.**
- **ALWAYS KEEP FINGERS AND OTHER PARTS OF YOUR BODY AWAY FROM THE MUZZLE AND AWAY FROM THE PISTOL SLIDE AND EJECTION PORT.**
- **ALWAYS WEAR ADEQUATE AND PROPER HEARING PROTECTION SPECIFIED FOR USE WITH FIREARMS** to prevent permanent damage to your hearing. Make sure others who are nearby are wearing hearing protection as well.
- **ALWAYS WEAR SAFETY GLASSES SPECIFIED FOR FIREARM USE,** whether indoors or out. Safety glasses should protect your eyes from the firing flash and particles associated with the discharge of ammunition. Failure to do so creates a risk of personal injury from particle or debris spitting or a ricochet.
- **ALWAYS BE ALERT AND ALWAYS FOLLOW THE SAFETY INSTRUCTIONS OF THE RANGE OFFICER.** Never shoot if you are tired, cold or impaired in any way.
- **ALWAYS BE AWARE OF OTHER PEOPLE** so that persons do not accidentally walk into the line of fire.
- **THE SHOOTER (AND ALL OTHERS IN THE SHOOTING AREA) MUST ALWAYS BE IN A POSITION THAT IS OUT OF THE LINE OF FIRE** and are not within an area where they may be struck by a ricochet or particles spitting from a firearm, or by ejected cases from some types of firearms.
- **NEVER SHOOT AT SURFACES THAT MAY CAUSE A RICOCHET.** Always select a place to shoot that has a safe backstop, is free from obstructions and has no surfaces which may cause a ricochet.
- **NEVER FIRE RANDOMLY INTO THE SKY.** Always select a place to shoot that has a safe backstop.
- **NEVER USE ALCOHOL OR DRUGS BEFORE OR WHILE SHOOTING OR HANDLING ANY FIREARM.**

---

# LOADING

---



**WARNING: ALWAYS KEEP THE MUZZLE POINTED IN A SAFE DIRECTION.**



**WARNING: SW1911 AND SW1911 E-SERIES™ PISTOLS WILL FIRE WITH THE MAGAZINE REMOVED. KEEP YOUR FINGER OFF THE TRIGGER AND OUTSIDE OF THE TRIGGER GUARD UNTIL YOU HAVE MADE THE COMMITMENT TO FIRE.**

- Do not load the pistol until you have read and fully understand this manual.
- Do not load the pistol until you are ready to use it. Keep your finger off the trigger and outside the trigger guard until you are ready to fire.
- Never load your pistol until you are sure of your target, what is beyond it and are fully prepared to fire.
- Smith & Wesson has provided you with a magazine designed to operate in your specific model of pistol. While your magazine may be able to be inserted into another model pistol, it will only function properly in the specific model for which it was designed. Do not interchange magazines from one model pistol into another model pistol.
- Follow instructions in this manual and any other specific instructions which may be marked onto, or accompany, a magazine. Failure to use the particular type of Smith & Wesson magazine specified for your model and caliber of pistol may result in a malfunction.
- Load the magazine by pressing a cartridge head (rear of cartridge) downward on the forward portion of the magazine follower (or downward on the case of the previously loaded cartridge) and sliding the cartridge fully under the lips of the magazine until the cartridge head is against the rear wall of the magazine (FIGURE 11). Repeat the procedure for the number of cartridges you wish to load, up to the magazine capacity. Do not attempt to load your magazine with more than the specified number of cartridges because doing so can cause a feeding failure.
- Inspect your pistol as previously described in the “Inspecting Your Pistol” section. Hold the pistol in one hand with the muzzle pointing in a safe direction and with your finger off the trigger and outside the trigger guard. Insert the loaded magazine into the magazine well (opening) of the pistol until it is locked in place.

**FIGURE 11**

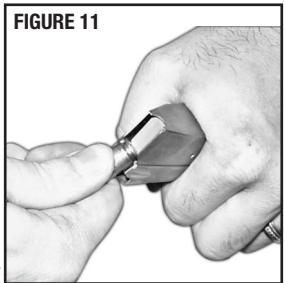

---

## LOADING CONTINUED

---



**WARNING: VERIFY THAT THE FIRING PIN IS NOT PROTRUDING FROM THE BREECH FACE. IF THE FIRING PIN IS PROTRUDING, MAKE SURE THE FIREARM IS POINTED IN A SAFE DIRECTION, UNLOAD THE FIREARM AND HAVE IT INSPECTED AND TEST FIRED BY A GUNSMITH QUALIFIED TO PERFORM SERVICE ON SMITH & WESSON FIREARMS.**



**WARNING: DO NOT USE EXCESSIVE UPWARD FORCE WHEN INSERTING A LOADED MAGAZINE INTO THE PISTOL. EXCESSIVE UPWARD FORCE COULD CAUSE AN OPEN SLIDE TO MOVE FORWARD, CHAMBERING A ROUND AND MAKING THE PISTOL READY TO FIRE.**

- To make sure that the magazine is fully and securely inserted, apply some removal pressure to the exposed portion of the magazine butt plate.



**WARNING: UPON RELEASING THE SLIDE FROM THE SLIDE STOP, THE SLIDE MOVES FORWARD WITH SIGNIFICANT FORCE AND SPEED. TO AVOID INJURY BE SURE NO PART OF YOUR BODY IS IN THE PATH OF THE SLIDE'S TRAVEL.**

- With the muzzle still pointing in a safe direction, grasp the serrated sides of the slide from the rear with the thumb and fingers as shown (FIGURE 12) and briskly draw the slide fully rearward and release it. This strips a cartridge from the magazine and seats it in the chamber of the barrel and at the same time, fully cocks the hammer.

**CAUTION:** The pistol can now be fired by pulling the trigger to the rear.

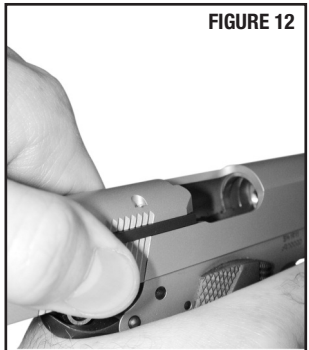

## LOADING CONTINUED



**WARNING: ALWAYS LOAD A ROUND INTO THE CHAMBER BY FEEDING IT FROM THE MAGAZINE. FAILURE TO FOLLOW THIS WARNING CAN RESULT IN SEVERE INJURY OR DEATH TO YOU OR OTHERS. NEVER ATTEMPT TO LOAD THE PISTOL BY INSERTING A ROUND INTO THE OPEN EJECTION PORT.**



**WARNING: IF THE CARTRIDGE FAILS TO STRIP FROM THE MAGAZINE OR FULLY SEAT INTO THE CHAMBER, IMMEDIATELY STOP THE LOADING PROCESS. REMOVE THE MAGAZINE, LOCK THE SLIDE OPEN AND VERIFY THAT THE CHAMBER IS EMPTY. REFER TO “INSPECTING YOUR PISTOL” SECTION OF THIS MANUAL.**

- With the muzzle pointed in a safe direction and your finger outside the trigger guard, place the safety lever in the fully up “safe” position (FIGURE 13).

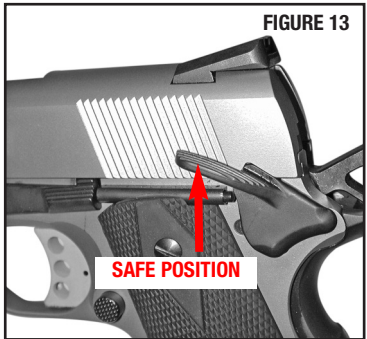

---

# FIRING

---



**WARNING: ALWAYS KEEP THE MUZZLE POINTED IN A SAFE DIRECTION.**



**WARNING: UPON FIRING THE PISTOL OR RELEASING THE SLIDE FROM THE SLIDE STOP, THE SLIDE MOVES REARWARD OR FORWARD WITH SIGNIFICANT FORCE AND SPEED. TO AVOID INJURY, BE SURE NO PART OF YOUR BODY IS IN THE PATH OF THE SLIDE'S TRAVEL.**



**WARNING: WEAR EYE AND HEARING PROTECTION SPECIFIED FOR USE WITH FIREARMS EVERY TIME YOU DISCHARGE YOUR FIREARM. MAKE SURE OTHERS IN THE VICINITY OF WHERE YOU WILL BE SHOOTING DO SO AS WELL.**



**WARNING: NEVER ATTEMPT TO CARRY YOUR PISTOL WITH THE HAMMER DOWN ON A LIVE CARTRIDGE. THIS WOULD REQUIRE YOU TO DECOCK THE PISTOL WITH A LIVE ROUND IN THE CHAMBER. DECOCKING THE HAMMER OVER A LIVE ROUND SHOULD NEVER BE ATTEMPTED. TO DO SO COULD RESULT IN SERIOUS INJURY OR DEATH TO YOU OR OTHERS.**

- With the pistol pointed in a safe direction and your finger off the trigger and outside the trigger guard, depress the safety lever fully down into the "fire" position. Check to make sure that the hammer is fully cocked. If it is not, cock it by drawing it fully back with the thumb of the shooting hand.
- To ensure proper firing control and to fully depress the grip safety, the pistol should now be gripped firmly with the shooting hand.
- Squeeze the trigger fully to the rear. This releases the hammer and fires the gun. Upon firing, the slide moves rearward thereby extracting and ejecting the spent cartridge case and returns the hammer to the fully cocked position.
- The slide then returns forward feeding the next cartridge from the magazine into the barrel chamber and the hammer has been recocked. This sequence can be repeated until the last round has been fired at which time the magazine follower exerts upward pressure on the slide stop causing it hold the slide in the "open" position.

# DECOCKING



**WARNING: ALWAYS KEEP THE PISTOL POINTED IN A SAFE DIRECTION.**



**WARNING: YOU MUST BE CERTAIN THAT THE CHAMBER IS UNLOADED. FAILURE TO VERIFY THE CHAMBER IS UNLOADED COULD RESULT IN THE PISTOL ACCIDENTALLY FIRING IF THE HAMMER SLIPS DURING DECOCKING.**

- If you decide not to fire and your handgun is in the fully cocked position, you must follow these instructions to safely decock the handgun.
- Remove your finger from the trigger and keep it outside of the trigger guard (FIGURE 14).
- Place the safety lever in the fully up “safe” position.
- Remove the magazine from the firearm.
- Place the safety lever in the fully down “fire” position.
- Draw the slide back and eject any chambered round. You must verify the barrel chamber is free of any live rounds or obstructions (FIGURE 15). Release the slide allowing it to move fully forward.
- Place your finger on the trigger and place the thumb of your opposite hand on the hammer (FIGURE 16).
- Pull the trigger to the rear and hold it while lowering the hammer to the forward position with your thumb and then release the trigger (FIGURE 17).

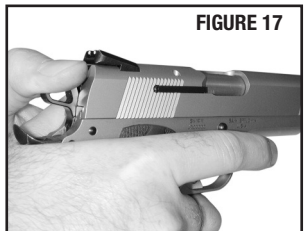
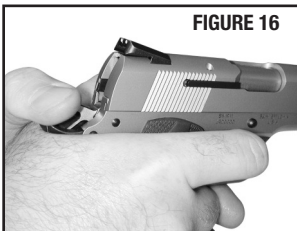
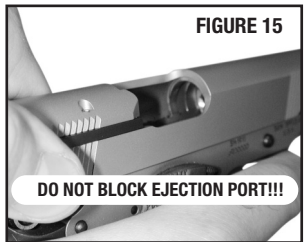

---

# CLEARING MISFIRES

---



**WARNING: IF YOUR HANDGUN GIVES ANY INDICATION THAT IT IS NOT PERFORMING PROPERLY OR THE OPERATION OF YOUR HANDGUN HAS CHANGED “THE WAY IT FEELS OR SOUNDS,” STOP FIRING. MAKE SURE THE FIREARM IS POINTED IN A SAFE DIRECTION, UNLOAD THE FIREARM AND HAVE IT INSPECTED AND TEST FIRED BY A GUNSMITH QUALIFIED TO PERFORM SERVICE ON SMITH & WESSON FIREARMS.**

- If a cartridge fails to fire, wait ten seconds while keeping the muzzle pointed in a safe direction.
- Keep your finger off the trigger and out of the trigger guard.
- Remove the magazine.
- The chamber must be manually cleared.
- Grasp the serrated sides of the slide from the rear and briskly pull the slide fully rearward to eject the misfired round (FIGURE 15). Do not obstruct the ejection port, and do not attempt to catch the round by placing your hand over the ejection port. Also, remember that any time you release the slide while a magazine containing cartridges is in the pistol, you will have reloaded the chamber.
- In order to lock the slide in the open position, allow the slide to move slightly forward from the rearmost position while pressing upward on the slide stop. You are now able to safely check the barrel chamber and bore visually for any obstructions.



**WARNING: SW1911 AND SW1911 E-SERIES™ PISTOLS ARE DESIGNED SO THAT THEY ARE ABLE TO FIRE WHEN THE MAGAZINE IS REMOVED. THEREFORE, IF THE MAGAZINE IS REMOVED FROM THE PISTOL AND THERE IS A LOADED ROUND IN THE CHAMBER, IT WILL FIRE IF THE TRIGGER IS PULLED. AFTER INSERTING A MAGAZINE, ALWAYS TEST TO MAKE SURE IT IS LOCKED IN PLACE BY APPLYING SOME REMOVAL PRESSURE TO THE EXPOSED PORTION OF THE MAGAZINE BUTT PLATE.**

# UNLOADING



**WARNING: ALWAYS KEEP YOUR PISTOL POINTED IN A SAFE DIRECTION. ALWAYS KEEP YOUR FINGER OFF THE TRIGGER AND OUTSIDE THE TRIGGER GUARD.**

- Point the muzzle in a safe direction. Keep your finger off the trigger and outside of the trigger guard.
- Ensure that the hammer is fully rearward and then place the safety lever in the fully up “safe” position (FIGURE 18).
- Depress the magazine release, and remove the magazine. Place the safety lever into the down “fire” position (FIGURE 19).

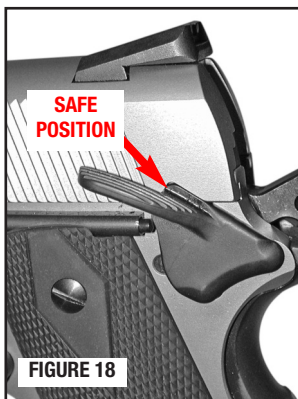

- With the muzzle still pointing in a safe direction, and with your finger off the trigger and outside the trigger guard, grasp the serrated sides of the slide (FIGURE 20) and briskly draw the slide fully rearward in order to extract any cartridge from the barrel chamber and clear it from the pistol. Do not obstruct the ejection port because doing so can interfere with ejection of a cartridge. Visually check the barrel chamber to be sure it is empty.

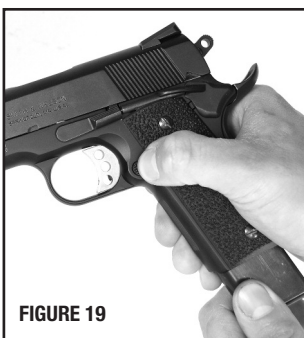

- Unload the magazine by holding it with the bullet end of the cartridge pointing away from you and pressing each cartridge forward and out of the magazine.

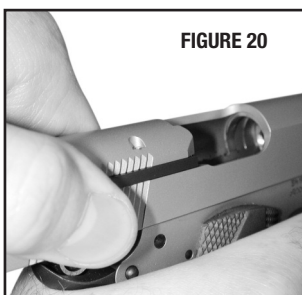



---

# REAR SIGHT ADJUSTMENT

---



**WARNING: ALWAYS ENSURE YOUR FIREARM IS UNLOADED BEFORE ADJUSTING YOUR SIGHTS. AT ALL TIMES FOLLOW THE BASIC RULES OF SAFE GUN HANDLING.**

- Certain model Smith & Wesson pistols are equipped with a fixed rear sight that is adjustable for windage only. To adjust, move the rear sight in the direction you wish the group to move on the target. For example, if the group should move to the right, move the rear sight to the right. Use a brass or plastic drift or punch to prevent marring the rear sight. If the rear sight has a set screw, loosen the set screw prior to moving the rear sight. Tighten the set screw after the sight has been adjusted to the desired position (FIGURE 21).



- Certain model Smith & Wesson pistols are equipped with a rear sight adjustable for both elevation and windage.

## ADJUSTING FOR ELEVATION

- Rotate the adjusting screw installed on the top of the rear sight clockwise to lower the rear sight or counterclockwise to raise the rear sight. (Raising rear sight will raise the group, etc.)

## ADJUSTING FOR WINDAGE

- Rotate the adjusting screw installed in the right side of rear sight clockwise to move the rear sight blade to the right or counterclockwise to move it to the left. (Moving rear sight to the right will move the group to the right, etc.).

---

# FIELD STRIPPING/DISASSEMBLY

## FOR MODELS WITH A BARREL BUSHING

---



**WARNING: ALWAYS KEEP THE MUZZLE POINTED IN A SAFE DIRECTION.**



**WARNING: ALWAYS ENSURE THAT THE FIREARM IS UNLOADED BEFORE INSPECTING, DISASSEMBLING OR ASSEMBLING.**



**WARNING: ALWAYS FOLLOW THE FIELD STRIPPING INSTRUCTIONS EXACTLY. NEVER DO ANYTHING BEYOND WHAT YOU ARE SPECIFICALLY INSTRUCTED TO DO IN THIS MANUAL. NEVER ALTER OR MODIFY THE PARTS IN YOUR PISTOL.**

## FIELD STRIPPING DISASSEMBLY FOR MODELS WITH A BARREL BUSHING CONTINUED



**WARNING: WEAR SAFETY GLASSES EVERY TIME YOU ASSEMBLE OR DISASSEMBLE YOUR FIREARM.**



**WARNING: THE RECOIL SPRING IS UNDER PRESSURE. YOU MUST CONTROL THE SPRING AND PLUNGER TO PREVENT IT FROM FLYING OUT AND CAUSING INJURY.**

- Point the pistol in a safe direction and remove the magazine, clear the chamber and verify that the firearm is unloaded.

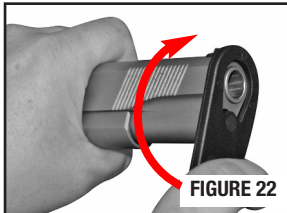

FIGURE 22

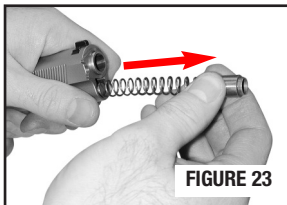

FIGURE 23

- Firmly grasp the pistol as shown (FIGURE 22) and use the wrench provided and depress the recoil spring retainer.



FIGURE 24

- Turn the wrench and barrel bushing clockwise, approximately 1/4 turn until the recoil spring retainer and recoil spring are free to be removed.

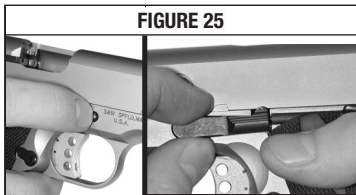

FIGURE 25

- Maintain a grip on the recoil spring retainer as it pushes out and catch the recoil spring (FIGURE 23).

- Fully cock the hammer to make it easier to push the slide back.



FIGURE 26

- Grasp the pistol and move the slide back until the takedown notch in the slide is aligned with the slide stop as shown (FIGURE 24).

- Press inward on the slide stop pin from the right side of the frame and remove the slide stop from the left side (FIGURE 25).

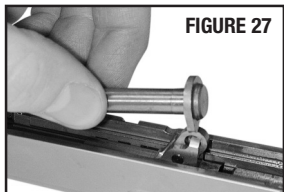

FIGURE 27

- Move the slide forward and off the frame (FIGURE 26).

- Turn the slide bottom side up and remove the recoil spring guide rod. Move the guide rod upwards away from the barrel towards the rear of the slide. Rotate the barrel link into the up position to give the guide rod adequate clearance for removal (FIGURE 27).

## FIELD STRIPPING DISASSEMBLY FOR MODELS WITH A BARREL BUSHING CONTINUED

- Rotate the barrel bushing counterclockwise until the bushing lug is aligned with the opening between the barrel and recoil spring holes (FIGURE 28). Pull the barrel bushing out the front of the slide.
- Rotate the barrel link to the forward position (lowered) and remove the barrel through the front of the slide (FIGURE 29).
- FIGURE 30 shows the parts you will have after field stripping a pistol that uses a barrel bushing.

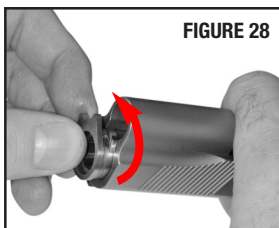

FIGURE 28

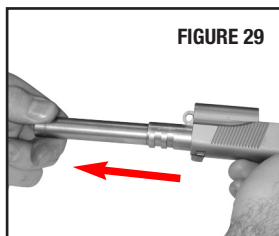

FIGURE 29

**WARNING: DO NOT DRY FIRE YOUR SW1911 AND SW1911 E-SERIES™ PISTOL WHILE THE SLIDE IS REMOVED. DOING SO CAN RESULT IN DAMAGE TO THE HAMMER OR OTHER INTERNAL PARTS.**

**WARNING: DO NOT ALTER, MODIFY OR REPLACE ANY OF THE PARTS OF YOUR FIREARM UNLESS THIS WORK IS PERFORMED BY A QUALIFIED GUNSMITH USING GENUINE SMITH & WESSON PARTS. IF YOU DO OTHERWISE, IMPROPER FUNCTIONING MAY OCCUR AND SERIOUS INJURY MAY RESULT. IT WILL ALSO VOID YOUR WARRANTY.**

**WARNING: NEVER DISASSEMBLE YOUR HANDGUN BEYOND THE FIELD STRIPPING PROCESS OUTLINED IN THIS MANUAL. NEVER MANIPULATE ANY INTERNAL COMPONENTS BEYOND WHAT YOU ARE SPECIFICALLY INSTRUCTED TO DO IN THIS MANUAL SINCE THIS MAY AFFECT THE RELIABILITY, FUNCTIONING AND SAFETY OF YOUR HANDGUN.**

**WARNING: PARTS FROM OTHER BRANDS OF PISTOLS MUST NEVER BE USED IN YOUR SW1911 EVEN THOUGH THE PARTS MAY APPEAR TO BE SIMILAR. USE OF ANY PARTS OTHER THAN GENUINE SW1911 PARTS MAY CAUSE A SERIOUS MALFUNCTION RESULTING IN INJURY OR DEATH TO YOU OR OTHERS AND DAMAGE TO PROPERTY.**

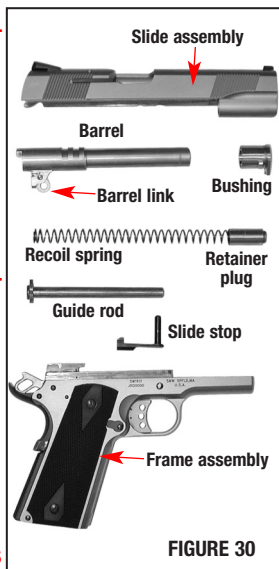

FIGURE 30

# FIELD STRIPPING / DISASSEMBLY

FOR MODELS WITH NO BARREL BUSHING



**WARNING: ALWAYS KEEP THE MUZZLE POINTED IN A SAFE DIRECTION.**



**WARNING: ALWAYS ENSURE THAT THE FIREARM IS UNLOADED BEFORE INSPECTING, DISASSEMBLING OR ASSEMBLING.**



**WARNING: ALWAYS FOLLOW THE FIELD STRIPPING INSTRUCTIONS EXACTLY. NEVER DO ANYTHING BEYOND WHAT YOU ARE SPECIFICALLY INSTRUCTED TO DO IN THIS MANUAL. NEVER ALTER OR MODIFY THE PARTS IN YOUR PISTOL.**



**WARNING: WEAR SAFETY GLASSES EVERY TIME YOU ASSEMBLE OR DISASSEMBLE YOUR FIREARM.**



**WARNING: THE RECOIL SPRING ASSEMBLY IS UNDER PRESSURE. YOU MUST CONTROL THE SPRING AND PLUNGER TO PREVENT IT FROM FLYING OUT AND CAUSING INJURY.**

- Point the pistol in a safe direction and remove the magazine, clear the chamber and verify that the firearm is unloaded (FIGURE 31).
- Fully cock the hammer to make it easier to push the slide back.
- Firmly grasp the pistol and apply rearward force on the slide and move it back until the takedown notch is aligned with the slide stop (FIGURE 32).
- Press inward on the slide stop pin from the right side of the frame (FIGURE 33).
- Remove the slide stop entirely from the left side (FIGURES 34 and 35).



## FIELD STRIPPING DISASSEMBLY FOR MODELS WITH NO BARREL BUSHING CONTINUED

- Move the slide forward and remove it from the frame, while keeping your hand around the recoil spring assembly to prevent it from flying out (FIGURE 36).
- Turn the slide bottom up. While keeping the spring and guide rod contained, lift up on the back end of the guide rod and slowly release the tension on the recoil spring.
- Remove the guide rod and recoil spring from under the barrel (FIGURE 37).

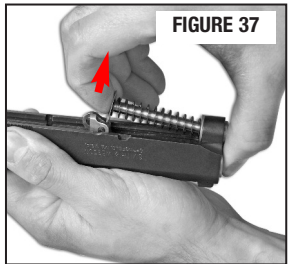
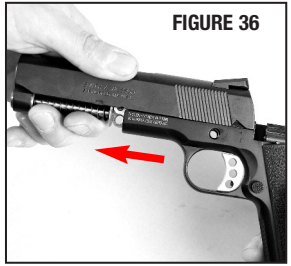

**WARNING: DO NOT DRY FIRE YOUR SW1911 AND SW1911 E-SERIES™ SERIES PISTOL WHILE THE SLIDE IS REMOVED. DOING SO CAN RESULT IN DAMAGE TO THE HAMMER OR OTHER INTERNAL PARTS.**

**WARNING: DO NOT ALTER, MODIFY OR REPLACE ANY OF THE PARTS OF YOUR FIREARM UNLESS THIS WORK IS PERFORMED BY A QUALIFIED GUNSMITH USING GENUINE SMITH & WESSON PARTS. IF YOU DO OTHERWISE, IMPROPER FUNCTIONING MAY OCCUR AND SERIOUS INJURY MAY RESULT. IT WILL ALSO VOID YOUR WARRANTY.**

**WARNING: NEVER DISASSEMBLE YOUR HANDGUN BEYOND THE FIELD STRIPPING PROCESS OUTLINED IN THIS MANUAL. NEVER MANIPULATE ANY INTERNAL COMPONENTS BEYOND WHAT YOU ARE SPECIFICALLY INSTRUCTED TO DO IN THIS MANUAL SINCE THIS MAY AFFECT THE RELIABILITY, FUNCTIONING AND SAFETY OF YOUR HANDGUN.**

**WARNING: PARTS FROM OTHER BRANDS OF PISTOLS MUST NEVER BE USED IN YOUR SW1911 EVEN THOUGH THE PARTS MAY APPEAR TO BE SIMILAR. USE OF ANY PARTS OTHER THAN GENUINE SW1911 PARTS MAY CAUSE A SERIOUS MALFUNCTION RESULTING IN INJURY OR DEATH TO YOU OR OTHERS AND DAMAGE TO PROPERTY.**

## FIELD STRIPPING DISASSEMBLY FOR MODELS WITH NO BARREL BUSHING CONTINUED

- Remove the recoil spring retainer plug as shown (FIGURES 38 and 39).



FIGURE 38

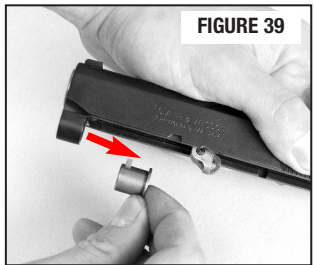

FIGURE 39

- Remove the barrel through the front of the slide (FIGURE 40).

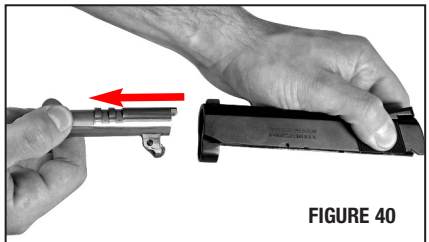

FIGURE 40

- Shown here (FIGURE 41) are the components of a sub compact SW1911 upon disassembly. This model does not make use of a barrel bushing.

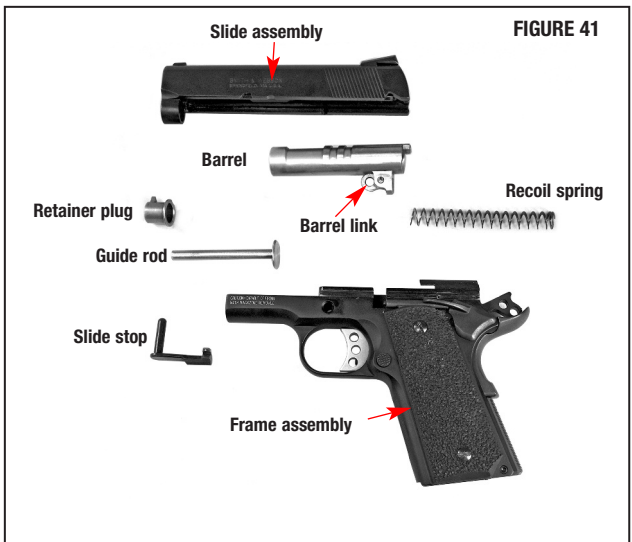

FIGURE 41

# FIELD STRIPPING/ASSEMBLY SW1911

FOR MODELS WITH A BARREL BUSHING



**WARNING: ALWAYS FOLLOW THE FIELD STRIPPING INSTRUCTIONS EXACTLY. NEVER DO ANYTHING BEYOND WHAT YOU ARE SPECIFICALLY INSTRUCTED TO DO IN THIS MANUAL. NEVER ALTER OR MODIFY THE PARTS IN YOUR MANUAL.**



**WARNING: WEAR SAFETY GLASSES EVERY TIME YOU ASSEMBLE OR DISASSEMBLE YOUR FIREARM.**



**WARNING: THE RECOIL SPRING IS UNDER PRESSURE. YOU MUST CONTROL THE SPRING AND PLUNGER TO PREVENT IT FROM FLYING OUT AND CAUSING INJURY.**

- Verify that the hammer is in the fully cocked position to make it easier to push the slide assembly into place.

- Ensure the barrel chamber is unloaded.

- Turn the slide bottom up, turn the barrel link forward and insert the barrel into the slide from the front. Align the barrel lug central to the slide (side to side) (FIGURE 42).

- Install the barrel bushing and push it until it contacts the front of the slide, then rotate it clockwise until the bushing lug is aligned with the opening between the barrel and recoil spring holes.

- Insert the recoil spring guide rod into the recoil spring housing from the rear of the slide.

- Be certain that the firing pin plunger lever is not sticking up - where it will catch on the slide as it is pushed rearward (FIGURES 43a and 43b). Do not squeeze the grip safety while putting the slide back onto the frame.

- Align the slide with the rails on the frame and gently push the slide onto the frame as shown (FIGURE 44).

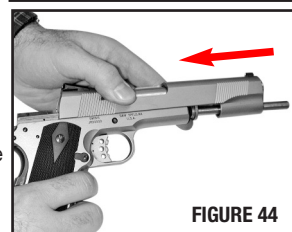
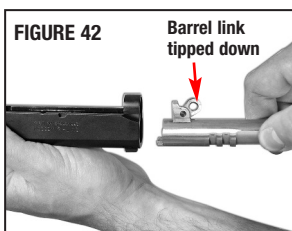

## FIELD STRIPPING / ASSEMBLY FOR MODELS WITH A BARREL BUSHING CONTINUED

- Move the slide and barrel rearward together until the barrel link hole is aligned with the slide stop hole (FIGURE 45). Insert the slide stop pin into the slide stop hole making sure it passes through the barrel link hole.

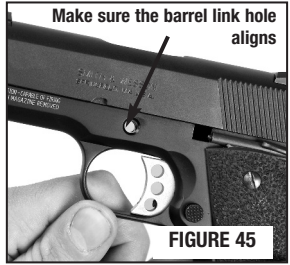

- Align the take down notch on the slide with the rectangular cutout of the frame (FIGURE 46).



- Push the slide stop pin all the way in so that its rearward tab passes through the take down notch and is locked into place (FIGURE 47).



- Slide the recoil spring onto the guide rod with the closed end of the spring going onto the guide rod first - against the flange of the guide rod (FIGURE 48 and 49).

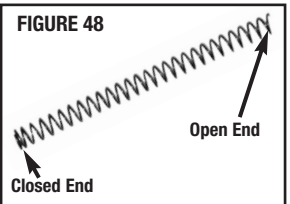

**CAUTION:** Be prepared for the recoil spring to push back

- Install the recoil spring retainer onto the end of the recoil spring and push it into the slide until it is slightly below the front end of the slide.

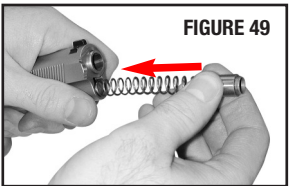

- Use the bushing wrench to turn the barrel bushing counter-clockwise until the recoil spring retainer locks the bushing into place (FIGURE 50).

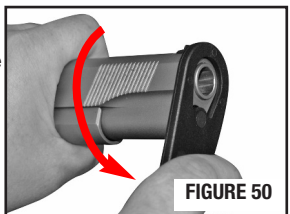



# FIELD STRIPPING / ASSEMBLY SW1911

FOR MODELS WITH NO BARREL BUSHING



**WARNING: ALWAYS FOLLOW THE FIELD STRIPPING INSTRUCTIONS EXACTLY. NEVER DO ANYTHING BEYOND WHAT YOU ARE SPECIFICALLY INSTRUCTED TO DO IN THIS MANUAL. NEVER ALTER OR MODIFY THE PARTS IN YOUR MANUAL.**



**WARNING: WEAR SAFETY GLASSES EVERY TIME YOU ASSEMBLE OR DISASSEMBLE YOUR FIREARM.**



**WARNING: THE RECOIL SPRING IS UNDER PRESSURE WHEN ASSEMBLING YOUR PISTOL. YOU MUST CONTROL THE SPRING AND PLUNGER TO PREVENT IT FROM FLYING OUT AND CAUSING INJURY.**

- Ensure the barrel chamber is unloaded.
- Verify that the hammer is in the fully cocked position to make it easier to push the slide into place.
- Turn the slide bottom side up, turn the barrel link forward and insert the barrel into the slide from the front (FIGURE 51).
- Insert the recoil retainer plug into position (FIGURE 52).
- Slide the recoil spring onto the guide rod with the closed end of the spring going onto the guide rod first - against the flange of the guide rod (FIGURE 53).
- Rotate the barrel link into the rearward (upright) position. Insert the spring and guide rod into the end of the recoil spring retainer plug (FIGURE 54).

FIGURE 51

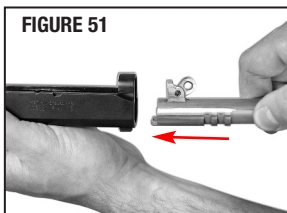

FIGURE 52

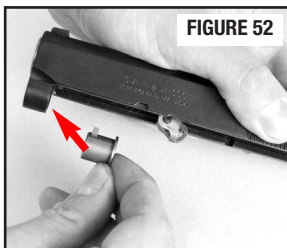

FIGURE 53

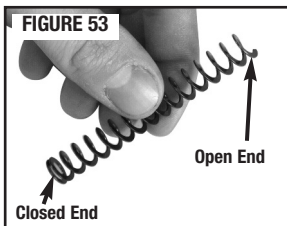
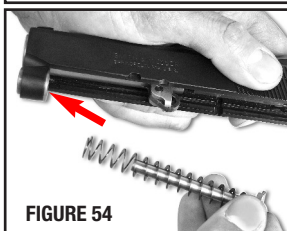

FIGURE 54



## FIELD STRIPPING / ASSEMBLY FOR MODELS WITH NO BARREL BUSHING CONTINUED



- Be certain that the firing pin plunger lever is not sticking up - where it will catch on the slide as it is pushed rearward (FIGURES 55a and 55b). Do not squeeze the grip safety while putting the slide back onto the frame.



- Align the barrel lug central to the slide (side to side) (FIGURE 56).



- Move the slide and barrel rearward together until the barrel link hole is aligned with the slide stop hole (FIGURE 57).

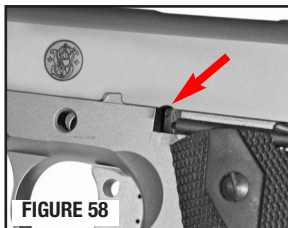

- Align the take down notch on the slide with the rectangular cutout of the frame (FIGURE 58).

- Insert the slide stop pin into the slide stop hole making sure it passes through the barrel link hole.
- Push the slide stop pin all the way in so that its rearward tab passes through the take down notch. Press the slide stop fully against the frame (FIGURE 59).

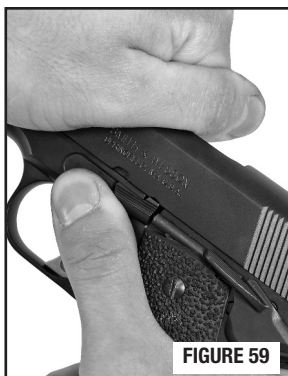

# FIELD STRIPPING/ ASSEMBLY

## SW1911 E-Series™

**WARNING: ALWAYS FOLLOW THE FIELD STRIPPING INSTRUCTIONS EXACTLY. NEVER DO ANYTHING BEYOND WHAT YOU ARE SPECIFICALLY INSTRUCTED TO DO IN THIS MANUAL. NEVER ALTER OR MODIFY THE PARTS IN YOUR MANUAL.**

**WARNING: WEAR SAFETY GLASSES EVERY TIME YOU ASSEMBLE OR DISASSEMBLE YOUR FIREARM.**

**WARNING: THE RECOIL SPRING IS UNDER PRESSURE WHEN ASSEMBLING YOUR PISTOL. YOU MUST CONTROL THE SPRING AND PLUNGER TO PREVENT IT FROM FLYING OUT AND CAUSING INJURY.**

- The procedure to reassemble these pistols is the same as that of the SW1911 pistols (detailed in the preceding pages) with one exception: The SW1911 E-Series™ pistols use a titanium firing pin and have no firing pin plunger and the associated plunger lever that might be sticking up from the frame (when the grip safety is held in) - where it will catch on the slide as it is pushed rearward.

## LUBRICATION

- There are four (4) lubrication points on the slide (FIGURE 60a) where a single drop of firearm lubricant should be applied. The other spots that should get a drop of oil are the top of the barrel (FIGURE 60b) and the top of the recoil spring guide rod. This will assure proper lubrication of your pistol. Care should be taken not to over-lubricate. Excess lubricant can collect large quantities of unburned powder and carbon residue, which could interfere with proper functioning of the pistol.

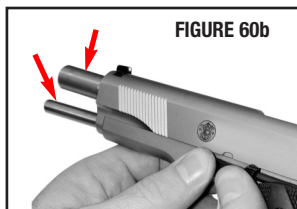
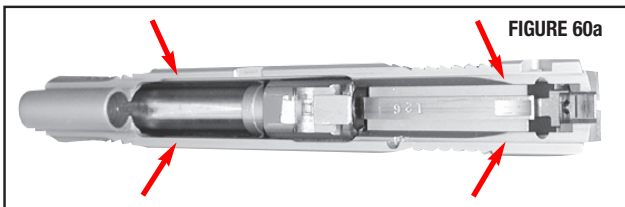

# MAGAZINE



**WARNING: WEAR SAFETY GLASSES EVERY TIME YOU ASSEMBLE OR DISASSEMBLE YOUR MAGAZINE.**



**WARNING: THE MAGAZINE SPRING IS UNDER PRESSURE. CONTROL THE SPRING AND FOLLOWER SO THAT THEY DO NOT FLY OUT AND CAUSE INJURY.**

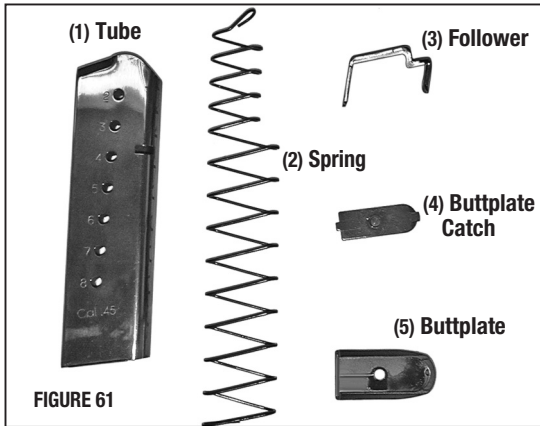

**FIGURE 61**

## **MAGAZINE DISASSEMBLY (see FIGURE 61)**

- Remove all cartridges from the magazine and your work area.
- Using a drift punch, depress the buttplate catch (4) through hole in the magazine buttplate. (5)
- Slide magazine buttplate (5) off of the magazine tube (1) while holding the buttplate catch (4) in the magazine tube (1).
- Remove the buttplate catch (4) and magazine spring (2) out through the bottom of magazine tube (1).
- Turn magazine tube (1) right side up and remove magazine follower (3) through the bottom of the magazine tube (1).

## **MAGAZINE ASSEMBLY (reference FIGURE 61)**

- Install magazine follower (3) in the bottom of the magazine tube (1) with the stepped edge of the magazine follower (3) toward the round side of the magazine tube (1).
- Install the magazine spring (2) and the buttplate catch (4) in the magazine tube (1).
- While holding buttplate catch (4) in the magazine tube (1), slide the magazine buttplate (5) onto the magazine tube (1) so that the circular projection of the buttplate catch (4) engages the magazine buttplate (5).

---

# CLEANING AND MAINTENANCE

---



**WARNING: ENSURE THAT YOUR FIREARM IS UNLOADED BEFORE BEGINNING TO CLEAN IT. (SEE “INSPECTING YOUR FIREARM” SECTION). ALWAYS FOLLOW THE RULES OF SAFE GUN HANDLING.**



**WARNING: WEAR SAFETY GLASSES EVERY TIME YOU ASSEMBLE OR DISASSEMBLE YOUR FIREARM AND ATTEMPT CLEANING OR MAINTENANCE.**

- Before using your firearm for the first time, it should be cleaned.
- Your firearm was treated at the factory with either a preservative or oil to protect it against corrosion during shipping and storage.
- Preservative and oil should be wiped from the bore, chamber and exposed areas using a clean swab or patch before using the firearm.

**CAUTION:** Never disassemble your firearm beyond the instructions in the Field Stripping and Inspection sections of this manual.

- Purchase cleaning supplies from your firearms dealer that are specifically designated for your type and caliber of firearm. Many suppliers offer these in kit form for your convenience.
- Follow the instructions provided with your cleaning supplies.

**NOTE:** A basic firearm cleaning kit should include: a brass bore brush and a cleaning jag of appropriate size for the bore being cleaned, high-quality gun cleaning solvent and gun oil/lubricant, cotton cleaning patches and a cleaning rod that is long enough to push the brush and jag completely through the barrel.

- Remove excessive firing residue from the bore and chamber using a properly fitted brass brush dipped in gun cleaning solvent. Finish the bore cleaning process by running a dry cotton cloth patch through the bore to remove residue and solvent.
- Clean the exterior of the firearm using a non-abrasive cleaning cloth.
- After cleaning, lightly coat the metal parts, internal and external with a high quality gun oil. Refer to the “Lubrication” section in this manual for instructions on lubricating the firearm.
- Whenever your firearm has been exposed to sand, dust, extreme humidity, water or other adverse conditions, it must be cleaned and lubricated.

---

## CLEANING AND MAINTENANCE CONTINUED

---



**WARNING: ALWAYS HAVE ADEQUATE VENTILATION. CLEANING FIREARMS IN POORLY VENTILATED AREAS, DISCHARGING FIREARMS, OR HANDLING AMMUNITION MAY RESULT IN EXPOSURE TO LEAD AND OTHER SUBSTANCES KNOWN TO CAUSE BIRTH DEFECTS, REPRODUCTIVE HARM, AND OTHER SERIOUS PHYSICAL INJURY. WASH HANDS THOROUGHLY AFTER EXPOSURE.**

**CAUTION:** Always follow the instructions provided with your gun cleaner and gun lubricant.

**CAUTION:** Some cleaners can cause damage to your firearms. You should avoid prolonged solvent immersion and prolonged ultrasonic cleaning of your firearm. Choice of solvent should be restricted to those products specifically developed for firearms maintenance. Damage to a firearm's finish may occur if these cautions are ignored. Ammoniated solvents or other strong alkaline solvents, should not be used on any Smith & Wesson firearm.

- Cleaning is essential to ensure the proper functioning of your firearm.
- Your firearm is a precision instrument. To ensure reliable function it is necessary to follow a routine maintenance procedure. After firing your firearm, be sure to unload it following the procedure outlined in the section entitled "Inspecting Your Firearm" before performing any cleaning or maintenance procedure.
- Remove any gun cleaning solution, oil and fingerprints from the outside surfaces of the firearm. (Finger moisture, if left, could start a corrosion process.)



**WARNING: NEVER MANIPULATE, ADJUST OR CHANGE ANY OF THE INTERNAL COMPONENTS OF YOUR FIREARM UNLESS SPECIFICALLY DIRECTED TO DO SO IN THIS MANUAL. IMPROPER MANIPULATION OF ANY INTERNAL COMPONENT MAY AFFECT THE SAFETY AND RELIABILITY OF YOUR FIREARM AND MAY CAUSE SERIOUS INJURY OR DEATH.**



**WARNING: ANY MAINTENANCE OR SERVICE NOT SPECIFIED IN THIS MANUAL MUST BE PERFORMED BY A QUALIFIED GUNSMITH USING GENUINE SMITH & WESSON PARTS. IF YOU DO OTHERWISE, IMPROPER FUNCTIONING OF YOUR FIREARM MAY OCCUR AND SERIOUS INJURY OR DEATH MAY RESULT.**

- If your firearm will be used in a cold climate, be sure to use an oil of an appropriate weight so that it will not congeal in cold temperatures, causing the interaction of important parts to be slowed or halted.

---

## CLEANING AND MAINTENANCE CONTINUED

---

### MAINTENANCE BEFORE STORAGE

- When storing, do not encase your firearm in anything that will attract or hold moisture, for example, leather or heavy cloth. Also, do not store guns with a plug inserted in the barrel for this can be a contributing factor to moisture accumulation. If your firearm is to be stored for an extended period, the bore, chambers and internal working mechanism should be oiled with a high quality lubricating oil or preservative intended for firearms. The external working mechanisms and barrel should be coated with an anti-rust oil. Before using your firearm again, be sure to clean it. Every time you clean your firearm, check it for signs of wear. If wear is noted, do not use the firearm. Return it to Smith & Wesson for service or have it checked by a qualified gunsmith.

---

# LIMITED WARRANTY

For Owners Within The United States.

---

This warranty is granted by Smith & Wesson Corp. This warranty is effective from the date of purchase and applies to the original owner of any firearm. With respect to such firearms, this warranty supersedes any and all other warranties.

Smith & Wesson firearms are warranted to be free from defects in material and workmanship. Any such defects of which Smith & Wesson receives written notice within one year from the date of purchase by the original owner, will be remedied by Smith & Wesson without charge within a reasonable time after such notification and delivery of the firearm as provided below.

In the event of an emergency (repairs needed by law enforcement, an upcoming match or hunting trip), call 1-800-331-0852, ext. 4125 and ask for 911 Priority Repair Service. This allows you to speak with a Smith & Wesson representative. Immediately upon receipt, your firearm will be assigned to a gunsmith. After the work is completed, we will return your Smith & Wesson firearm via overnight delivery.

To submit a warranty claim please see the "Contact and Shipping Information" below for details. In addition to the requested information, please include a copy of the bill of sale in the owner's name, or a copy of the ATF Form 4473 indicating date of purchase. It is always important that the owner comply with all applicable federal, state and local laws and regulations.

Warranty claims should state the model and serial number of the firearm concerned and the description of the difficulty experienced. It is recommended that shipments be insured by the owner, since Smith & Wesson will accept no responsibility for loss or damage in transit. Transportation and insurance charges for return to owner will be paid by Smith & Wesson if the claim is covered by the warranty.

UNDER NO CIRCUMSTANCES SHALL SMITH & WESSON BE RESPONSIBLE FOR INCIDENTAL OR CONSEQUENTIAL DAMAGES WITH RESPECT TO ECONOMIC LOSS, INJURY, DEATH OR PROPERTY DAMAGE, WHETHER AS A RESULT OF BREACH OF THIS WARRANTY, NEGLIGENCE OR OTHERWISE.

Some states do not allow the exclusion or limitation of incidental or consequential damages, so the above limitation or exclusion may not apply to you.

Smith & Wesson will not be responsible for:

- Defects or malfunctions resulting from careless handling, unauthorized adjustments or modifications made or attempted by anyone other than a qualified gunsmith following Smith & Wesson authorized procedures, or failure to follow the disassembly instructions in the Smith & Wesson manual.



---

## LIMITED WARRANTY CONTINUED

---

- Use of defective or improper ammunition, corrosion, neglect, abuse, ordinary wear and tear, or unreasonable use.
- Criminal misuse, negligence or use under the influence of drugs or alcohol.

Smith & Wesson's Lifetime Service Policy begins after the warranty period has expired. Smith & Wesson will repair, without charge, for the lifetime of the original owner, any Smith & Wesson handgun purchased on or after February 1, 1989, and any M&P15 series rifle, that is found to have a defect in material or workmanship. Eligibility for this Lifetime Service Policy requires returning the Product Registration Card within 30 days of purchase. The Lifetime Service Policy covers functional defects; it does not include the firearm's finish, grips, magazines or sights. The Lifetime Service Policy is in addition to and not an extension of the Smith & Wesson Warranty.

This warranty gives you specific legal rights. You may also have other rights that vary from state to state.

**NOTE:** All liability is excluded in the event that the instructions in the Smith & Wesson manual are not observed.

---

# CONTACT AND SHIPPING INFORMATION

For Owners Within The United States

---

**NOTE:** A Return Merchandise Authorization (**RMA**) is the first step in the process of returning a product in order to receive a repair, replacement or refund. Please contact Smith & Wesson's Customer Service Dept. (via e-mail: [qa@smith-wesson.com](mailto:qa@smith-wesson.com) or by phone at 800-331-0852 ext. 4125) to obtain authorization to return your firearm so we can process it quickly and efficiently. The RMA number that is supplied by Smith & Wesson must be displayed on the outside of the returned product's packaging; returns without an RMA number will be routed differently which will result in delayed processing.

The Return Merchandise Authorization (**RMA**) process allows Smith & Wesson an opportunity to try to diagnose and correct a customer's concerns with the product (such as ammunition problems) before it is returned. Accordingly, please contact us before returning your Smith & Wesson firearm.

**CONTACT CUSTOMER SERVICE**

Tel: 800-331-0852 ext. 4125

E-mail: [qa@smith-wesson.com](mailto:qa@smith-wesson.com)

**RETURNS - FOR SERVICE**

**ALL SMITH & WESSON FIREARMS**

Smith & Wesson  
2100 Roosevelt Avenue  
Springfield, MA 01104

Should your Smith & Wesson firearm require service, it should be returned to the Smith & Wesson factory.

- Call or e-mail the Customer Service Dept. for authorization and shipping instructions.
- Ensure that the firearm is unloaded.
- **Do not attempt to ship a firearm via US Postal Service; only federally licensed dealers may ship a firearm by US Postal Service.**
- **DO NOT SHIP ANY AMMUNITION.**

---

## CONTACT AND SHIPPING CONTINUED

---

- Enclose a letter which includes your full name and address (no P.O. Boxes, please), daytime telephone number, e-mail address, the serial number of the firearm, and details of the problem experienced (stating the brand and type of ammunition used when the problem occurred) or work desired.
- Record the serial number before shipping, in case you wish to check on the repair status of your firearm.
- Please remove all custom parts and accessories, such as stocks, special sights and scopes, or slings from your firearm before returning.
- Place the firearm in its original case or in a similarly secure container and pack it securely.
- The package must **NOT** bear any markings which indicate the identity of the contents.
- It is most important that you comply with federal, state, and local laws and regulations. The following guidelines are meant to help, but you must seek assistance from the appropriate authorities if necessary.
- If your firearm must be replaced, it may be necessary to ship the replacement to a dealer rather than directly to you. You will be requested to furnish a signed FFL (Federal Firearms License) from your dealer in such an instance.
- Warranty repair work will begin upon receipt and examination of the firearm. In the case of repairs or work not covered by the warranty, a quotation covering the cost of the work plus round trip transportation charges will be sent to you. Repairs or modification will be scheduled upon receipt of payment.
- A parts list can be obtained by contacting Smith & Wesson Customer Service.



**WARNING: YOU MAY PURCHASE ACCESSORIES FOR YOUR SMITH & WESSON FIREARM. YOU MUST HAVE SOME OF THESE PARTS INSTALLED BY A GUNSMITH QUALIFIED TO PERFORM SERVICE ON SMITH & WESSON FIREARMS. YOU MUST NEVER ATTEMPT TO MODIFY YOUR FIREARM OR INSTALL REPLACEMENT PARTS IN YOUR FIREARM. ALWAYS USE A QUALIFIED SMITH & WESSON GUNSMITH EVEN IF THE REPAIR SEEMS TO BE SIMPLE.**

---

# BATTERY WARNINGS

---



**WARNING: IF A BATTERY OPERATED ACCESSORY OR ATTACHMENT (I.E. LASER, OPTICAL SIGHT OR FLASH-LIGHT, ETC.) IS SUPPLIED OR USED WITH THIS FIREARM, THE FOLLOWING WARNINGS AND INSTRUCTIONS MUST BE ADHERED TO.**



**WARNING: KEEP BATTERIES AWAY FROM CHILDREN. THERE IS A CHEMICAL BURN HAZARD ASSOCIATED WITH BATTERIES.**



**WARNING: IF A NEW OR USED LITHIUM BUTTON/COIN CELL BATTERY IS SWALLOWED OR ENTERS THE BODY, IT CAN CAUSE SEVERE INTERNAL BURNS AND CAN LEAD TO DEATH IN AS LITTLE AS 2 HOURS. ALWAYS COMPLETELY SECURE THE BATTERY COMPARTMENT. IF THE BATTERY COMPARTMENT DOES NOT CLOSE SECURELY, STOP USING THE PRODUCT, REMOVE THE BATTERIES, AND KEEP IT AWAY FROM CHILDREN. IF YOU THINK BATTERIES MIGHT HAVE BEEN SWALLOWED OR PLACED INSIDE ANY PART OF THE BODY, SEEK IMMEDIATE MEDICAL ATTENTION.**

- When used correctly, batteries provide a safe and dependable source of portable power. However, misuse or abuse may result in leakage, fire, or explosion.
- Batteries can explode or leak and cause burns if installed backwards, disassembled, charged, or exposed to water, fire or high temperature.
- Always take care to install your batteries correctly observing the “+” and “-” marks on the battery and the device.
- Always replace the whole set of batteries at one time, taking care not to mix old and new batteries, or batteries of different types.
- Store unused batteries in their original packaging and away from metal objects that may short-circuit them.
- Remove discharged batteries from equipment promptly to avoid possible damage from leakage.
- Never dispose of batteries in fire. (Failure to observe this precaution may result in an explosion.)
- The batteries are supplied in a charged state and are not designed for recharging. Recharging may cause leakage, fire, or explosion.
- The batteries should be disposed of properly, including keeping them away from children.
- Dispose of used batteries immediately. Even used batteries may cause injury.

**This handgun is not equipped with a device that fully blocks use by unauthorized users. More than 200,000 firearms like this one are stolen from their owners every year in the United States. In addition, there are more than a thousand suicides each year by younger children and teenagers who get access to firearms. Hundreds more die from accidental discharge. It is likely that many more children sustain serious wounds or inflict such wounds accidentally on others. In order to limit the chance of such misuse, it is imperative that you keep this pistol locked in a secure place and take other steps necessary to limit the possibility of theft or accident. Failure to take reasonable preventative steps may result in innocent lives being lost, and in some circumstances may result in your liability for these deaths.**

The certification below is required only for handguns sold in the United States with a barrel length shorter than 3".

Smith & Wesson Corp. hereby certifies average accuracy test results for all new handguns with a barrel shorter than 3" as follows:

7 yards	14 yards	21 yards
1.7"	3.9"	6.3"

This certification is based on tests conducted by Smith & Wesson Corp. using a fixed handgun, rest and firing ammunition manufactured by a member of the Shooting Arms and Ammunition Manufacturers Institute (SAAMI) as defined in ANSI/SAAMI Z299.3-1993.

This certification represents actual tests based on several handguns, selected at random. Your particular handgun may have accuracy better than the results stated in this certification.

---

# CUSTOM SERVICE

---

- We understand that Smith & Wesson gun owners may want to enhance their guns with custom gunsmithing, refinishing or accessories. Our gunsmiths offer specialized services and exclusive products to enhance your shooting experience.
- Accessories for your Smith & Wesson firearm are available from your local Smith & Wesson Stocking Dealer, or directly from Smith & Wesson.
- Contact the Customer Service Department at 1-800-331-0852, ext. 4125 for information about these services.

When ordering directly from the factory, please provide the following information:

- Model Number
- Dash Number
- Serial Number
- Approximate date of purchase
- Complete Return Address
- VISA/Discover/MasterCard Number and Expiration Date
- For Foreign Orders Only, Fax Number or E-mail Address

---

# PATENT INFORMATION

---

- This product may be covered by one or more patents. Visit [www.smith-wesson.com](http://www.smith-wesson.com) for virtual patent information.

---

## INTERNATIONAL WARRANTY CENTERS

For Owners Outside The United States

---

**NOTE:** Addresses and contact information for International Warranty Centers is available on the Smith & Wesson website at [www.smith-wesson.com](http://www.smith-wesson.com) or by calling Customer Service toll-free at 1-800-331-0852 ext 4125.



44 1330000

Smith & Wesson®  
2100 Roosevelt Avenue • Springfield, MA 01104  
[www.smith-wesson.com](http://www.smith-wesson.com)

p/n 441330000

REV:SW1911\_080118