

# INSTRUCTION MANUAL FOR



## RUGER® 22 CHARGER™

STANDARD, TAKEDOWN, & TAKEDOWN LITE  
AUTOLOADING PISTOLS



– RUGGED, RELIABLE FIREARMS® –



**READ THE INSTRUCTIONS AND  
WARNINGS IN THIS MANUAL CAREFULLY  
BEFORE USING THIS FIREARM**

© 2022 Sturm, Ruger & Co., Inc.

This manual may not be reproduced in whole or in part without the express written permission of Sturm, Ruger & Co., Inc.

**For Service on This Model Please Call:  
(336) 949-5200 (See p. 34)**

THIS INSTRUCTION MANUAL SHOULD ALWAYS ACCOMPANY THIS FIREARM AND BE  
TRANSFERRED WITH IT UPON CHANGE OF OWNERSHIP, OR WHEN THE FIREARM IS LOANED  
OR PRESENTED TO ANOTHER PERSON

RUGER.COM

BH 8/2022 R9

## State-By-State Warnings

Certain states require by law that their own specified warning notices in larger-than-normal type be conspicuously included by the manufacturer, distributor or retailer with firearms sold in that state. Sturm, Ruger & Co., Inc. sells its products in compliance with applicable laws and regulations. Because our products may be sold in these states, we include the following:

### California:

#### **WARNING**

“Firearms must be handled responsibly and securely stored to prevent access by children and other unauthorized users. California has strict laws pertaining to firearms, and you may be fined or imprisoned if you fail to comply with them. Visit the Web site of the California Attorney General at <https://oag.ca.gov/firearms> for information on firearm laws applicable to you and how you can comply.

Prevent child access by always keeping guns locked away and unloaded when not in use. If you keep a loaded firearm where a child obtains and improperly uses it, you may be fined or sent to prison.

If you or someone you know is contemplating suicide, please call the national suicide prevention lifeline at 1-800-273-TALK (8255).”

#### **ADVERTENCIA**

“Las armas de fuego deben manipularse de manera responsable y segura para evitar el acceso de niños y otros usuarios no autorizados. California tiene leyes estrictas relacionadas con armas de fuego, y usted puede ser multado o encarcelado si no las cumple. Visite el sitio web del Procurador General de California en <https://oag.ca.gov/firearms> para obtener información sobre las leyes de armas de fuego que le son aplicables y cómo puede cumplirlas.

A los niños los atraen las armas de fuego y las pueden hacer funcionar. Ellos pueden causarse lesiones graves y la muerte. Evite que los niños tengan acceso a las armas de fuego guardándolas siempre con llave y descargadas cuando no las esté utilizando. Si usted tiene un arma de fuego cargada en un lugar en que un niño tiene acceso a ella y la usa indebidamente, le pueden dar una multa o enviarlo a la cárcel.

Si usted o alguien que conoce está pensando en suicidarse, llame a la línea nacional de prevención del suicidio al 1-800-273-TALK (8255).”

## **Connecticut:**

“UNLAWFUL STORAGE OF A LOADED FIREARM MAY RESULT IN IMPRISONMENT OR FINE.”

## **Florida:**

“IT IS UNLAWFUL, AND PUNISHABLE BY IMPRISONMENT AND FINE, FOR ANY ADULT TO STORE OR LEAVE A FIREARM IN ANY PLACE WITHIN THE REACH OR EASY ACCESS OF A MINOR UNDER 18 YEARS OF AGE OR TO KNOWINGLY SELL OR OTHERWISE TRANSFER OWNERSHIP OR POSSESSION OF A FIREARM TO A MINOR OR A PERSON OF UNSOUND MIND.”

## **Maine:**

“ENDANGERING THE WELFARE OF A CHILD IS A CRIME. IF YOU LEAVE A FIREARM AND AMMUNITION WITHIN EASY ACCESS OF A CHILD, YOU MAY BE SUBJECT TO FINE, IMPRISONMENT OR BOTH. KEEP FIREARMS AND AMMUNITION SEPARATE. KEEP FIREARMS AND AMMUNITION LOCKED UP. USE TRIGGER LOCKS.”

## **Maryland:**

“WARNING: Children can operate firearms which may cause death or serious injury. It is a crime to store or leave a loaded firearm in any location where an individual knew or should have known that an unsupervised minor would gain access to the firearm. Store your firearm responsibly!”

## **Massachusetts:**

“WARNING FROM THE MASSACHUSETTS ATTORNEY GENERAL: This handgun is not equipped with a device that fully blocks use by unauthorized users. More than 200,000 firearms like this one are stolen from their owners every year in the United States. In addition, there are more than a thousand suicides each year by younger children and teenagers who get access to firearms. Hundreds more die from accidental discharge. It is likely that many more children sustain serious wounds, or inflict such wounds accidentally on others. In order to limit the chance of such misuse, it is imperative that you keep this weapon locked in a secure place and take other steps necessary to limit the possibility of theft or accident. Failure to take reasonable preventive steps may result in innocent lives being lost, and in some circumstances may result in your liability for these deaths.”

“IT IS UNLAWFUL TO STORE OR KEEP A FIREARM, RIFLE, SHOTGUN OR MACHINE GUN IN ANY PLACE UNLESS THAT WEAPON IS EQUIPPED WITH A TAMPER-RESISTANT SAFETY DEVICE OR IS STORED OR KEPT IN A SECURELY LOCKED CONTAINER.”

## **New Jersey:**

“IT IS A CRIMINAL OFFENSE TO LEAVE A LOADED FIREARM WITHIN EASY ACCESS OF A MINOR.”

## **New York:**

“THE USE OF A LOCKING DEVICE OR SAFETY LOCK IS ONLY ONE ASPECT OF RESPONSIBLE FIREARM STORAGE. FOR INCREASED SAFETY, FIREARMS SHOULD BE STORED UNLOADED AND LOCKED IN A LOCATION THAT IS BOTH SEPARATE FROM THEIR AMMUNITION AND INACCESSIBLE TO CHILDREN AND UNAUTHORIZED PERSONS.”

**North Carolina:**

“IT IS UNLAWFUL TO STORE OR LEAVE A FIREARM THAT CAN BE DISCHARGED IN A MANNER THAT A REASONABLE PERSON SHOULD KNOW IS ACCESSIBLE TO A MINOR.”

**Texas:**

“IT IS UNLAWFUL TO STORE, TRANSPORT, OR ABANDON AN UNSECURED FIREARM IN A PLACE WHERE CHILDREN ARE LIKELY TO BE AND CAN OBTAIN ACCESS TO THE FIREARM.”

**Wisconsin:**

“IF YOU LEAVE A LOADED FIREARM WITHIN THE REACH OR EASY ACCESS OF A CHILD YOU MAY BE FINED OR IMPRISONED OR BOTH IF THE CHILD IMPROPERLY DISCHARGES, POSSESSES, OR EXHIBITS THE FIREARM.”

\* \* \* \* \*

Please check with your licensed retailer or state police for additional warnings which may be required by local law or regulation. Such regulations change constantly, and local authorities are in the best position to advise you on such legal matters.

**FIREARMS SAFETY IS YOUR RESPONSIBILITY**  
**SAFETY MUST BE THE FIRST AND CONSTANT**  
**CONSIDERATION OF EVERY PERSON WHO HANDLES**  
**FIREARMS AND AMMUNITION.**

This instruction manual is designed to assist you in learning how to use and care for your RUGER® 22 CHARGER™ pistol properly. Please contact us if you have any questions.

Only when you are certain you fully understand the manual and can properly carry out its instructions should you practice loading, unloading, etc. with live ammunition. If you have any doubts about your ability to handle or use a particular type of firearm safely, you should seek supervised instruction. Such personalized instruction often is available from local firearm retailers, gun clubs or police departments. If none of these sources can help visit [nra.org](http://nra.org) or write to the following address:

National Rifle Association  
11250 Waples Mill Road  
Fairfax, VA 22030-7400

The person possessing a firearm has a full-time job. You cannot guess; You cannot forget; You must know how to use your firearm safely. **Do not use any firearm without having a complete understanding of its particular characteristics and safe use.** Remember: There is no such thing as a foolproof firearm.

# TABLE OF CONTENTS

State-By-State Warnings	2
Nomenclature	8
Locking Device Installation Instructions	9
General Information and Mechanical Characteristics	11
Operation of Safety	13
The Bolt Lock	14
22 Charger™ Takedown Barrel Assembly Instructions	15
Ammunition	17
Magazines	18
Loading the Magazine	19
To Load and Fire (With Magazine)	19
To Load and Fire (Without Magazine)	21
To Unload	22
To Extract and Eject a Chambered Cartridge	23
To Clear a Malfunction (“Jam” or “Misfire”)	23
To Minimize Malfunctions (“Jams” or “Misfires”)	24
Disassembly	26
Reassembly	27
Check Your Pistol’s Function	28
Magazine Inspection and Care	29
Care and Cleaning	29
Threaded Barrel Information (On Models So Equipped)	31
Attaching Picatinny Scope Base Rail	31
Storage	33
Service and Parts Policy	34
Shipping Firearms for Repair	34
Ordering Parts	35
Parts List	36
Parts Drawing	37
22 Charger™ Takedown Supplemental Parts List & Exploded View	38
<b>The Basic Rules of Safe Firearms Handling</b>	<b>39</b>
Warranty Information	44

“RUGER” is a registered U.S. trademark.



## WARNINGS OF GREAT IMPORTANCE ARE FOUND ON THE FOLLOWING PAGES:

Locking Devices	9	Malfunctions	25
Alterations	11	Bore Obstructions	25
National Firearms Act	12	Disassembly	26
Manual Safety	14	Lubrication	30
Ammunition	17	Barrel Nut	31
Lead Exposure	17	Storage	33
Firing	20	Shipping	34
Handling	21	Parts Purchasers	35
Unloading	21		

**OTHER CAUTIONS AND WARNINGS APPEAR THROUGHOUT THE MANUAL.**

# NOMENCLATURE

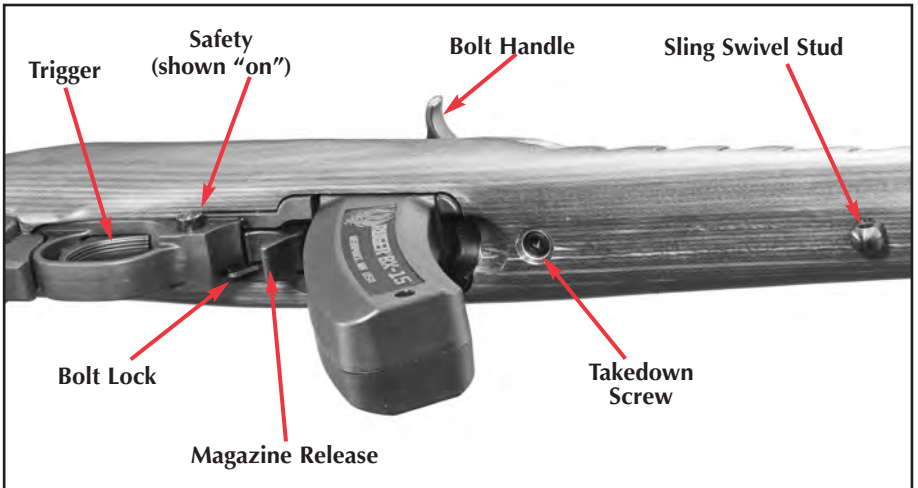
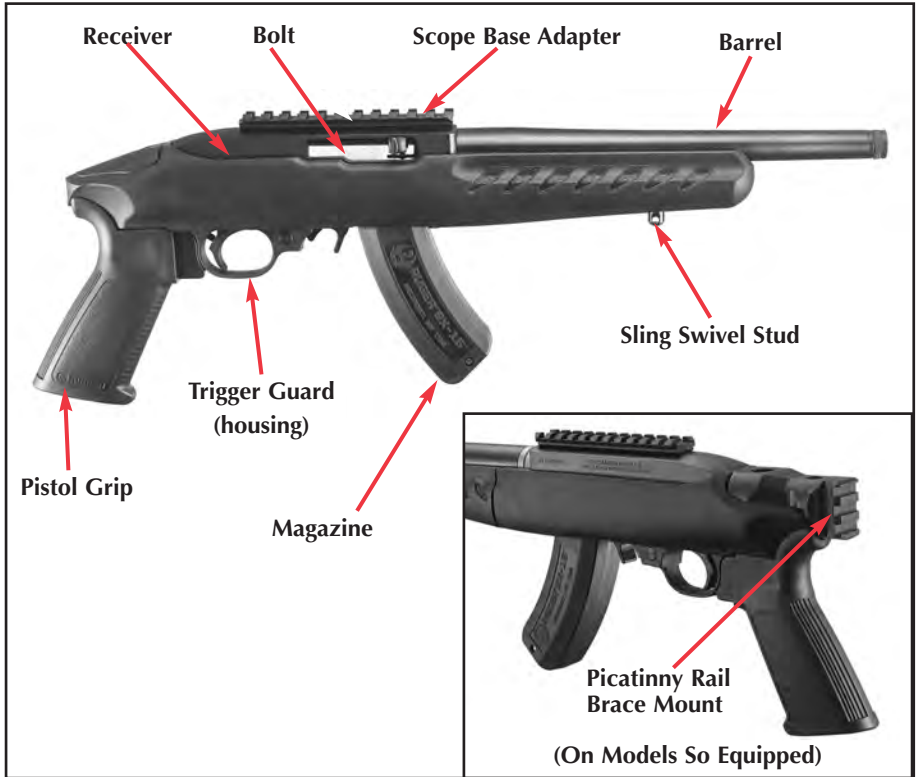

**Figure 1.** In these illustrations the frequently used operating components are identified. Note that the safety is protruding fully from the right side of the trigger guard and is therefore in its "on" (safe) position.



# LOCKING DEVICE INSTALLATION INSTRUCTIONS



## WARNING – USE OF LOCKING DEVICES



**Do not store keys  
in lock.**

- Always keep your firearm pointed in a safe direction, including when you are installing or removing your locking device.
- Always verify that your firearm is completely **unloaded** before installing your locking device.
- Do **not** install locking devices in the trigger guard; always keep your fingers and locking device outside the trigger guard during device installation and removal.
- Store firearms, ammunition and keys separately and securely, away from children and careless adults; do **not** store your firearm with the keys in the locking device.
- Do not attempt to work the action of your firearm with the locking device in place; this may damage your firearm.
- While locking devices are an important aid to security measures, they are not a substitute for safe firearm handling and proper storage. Remember that any mechanical device can be bypassed with enough time, knowledge, determination and equipment.

**LOCKING DEVICES MUST BE USED  
SAFELY AND RESPONSIBLY**

It is important to use the locking device on your Ruger® firearm when the firearm is stored or immediate use is not planned.

Keep the muzzle pointed in a safe direction and your fingers outside the trigger guard at all times!

### **To Install the Factory-Supplied Locking Device:**

1. Remove the magazine.
2. Be sure the firearm and its magazine are completely unloaded and contain no cartridges or cartridge cases!
3. Open the action completely. Use the bolt lock to keep the action open during installation of the locking device.

4. For the 22 Charger™ – Insert the free end of the cable into the ejection port and pull it through the magazine well as shown in Figure 2a.

Insert the free end of the cable into the lock. (See Figure 2b.)

5. For the 22 Charger™ Takedown *only* – Insert the free end of the cable into the ejection port and pull it through the receiver as shown in Figure 3.

Insert the free end of the cable into the lock. (See Figure 3.)

6. To lock: With the key turned to the farthest clockwise position, insert the loose end of the cable into the lock. Turn the key counterclockwise and remove the key.
7. Once the lock is securely closed, pull firmly on the lock to test the connection and be sure it is locked. **Do not leave or store your firearm with the key in the lock!** Store your locked unloaded firearm and the key in secure, separate locations, away from ammunition, children, and unauthorized adults.

Figure 2a



Figure 2b



Figure 3

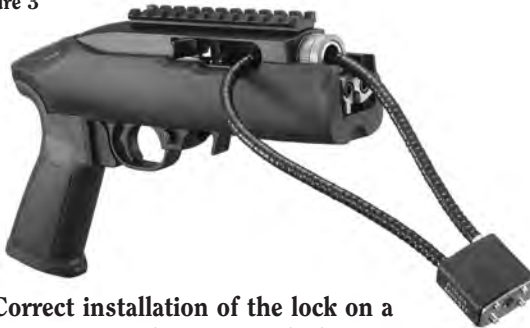

**FIREARMS ARE DANGEROUS WEAPONS.  
READ THE INSTRUCTIONS AND WARNINGS IN THIS  
MANUAL THOROUGHLY AND CAREFULLY BEFORE USING.**

 <b>WARNING - ALTERATIONS</b>	
	This product was designed to function properly in its original condition. Alterations can make it unsafe. Do not alter any part or add or substitute parts or accessories not made or sold by Sturm, Ruger & Co., Inc.
	<b>DO NOT ALTER ANY FIREARM</b>

## GENERAL INFORMATION AND MECHANICAL CHARACTERISTICS

The RUGER® 22 CHARGER™ pistol is an autoloading, recoil operated pistol. Retracting the bolt handle cocks the internal hammer and compresses the recoil spring. When the bolt is manually released, it moves forward (driven by the recoil spring), strips a cartridge from the magazine, if a loaded magazine is in place, and chambers the cartridge. The bolt is held against the chambered cartridge by the recoil spring.

When the trigger is pulled, the hammer is released and strikes the firing pin. The firing pin indents the cartridge case rim and ignites the priming compound inside the rim. This ignites the powder in the cartridge case and a great volume of gas is instantly generated, which acts on the interior of the cartridge case in all directions.

Because the bullet offers the least resistance, it moves out of the cartridge case and exits the muzzle. The bolt then moves rearward automatically, extracting and ejecting the fired cartridge case, and at the same time cocking the hammer and compressing the recoil spring, etc., as described above. Once the trigger is released, the pistol is ready to fire again.

Each time the trigger is pulled and released, the same cycle is repeated until there are no more cartridges in the magazine or in the chamber.

**The pistol will fire if there is a cartridge in the chamber and the trigger is pulled, whether or not there is a magazine in place! Removing the magazine does not unload the pistol. Never assume the pistol is unloaded. Visually inspect the chamber and the magazine each time the pistol is handled to be certain there are no cartridges in either.**

The RUGER® 22 CHARGER™ pistol, as equipped from the factory is not regulated by the National Firearms Act (“NFA”). However, alterations to the pistol (including installation of a stock or vertical fore-grip) may reclassify the pistol as an NFA-regulated firearm. For more information about the NFA, please visit [www.ATF.gov](http://www.ATF.gov). See also “Warning – National Firearms Act” below.



## WARNING – NATIONAL FIREARMS ACT

The National Firearms Act, 26 U.S.C. Chapter 53 (“NFA”), prohibits the unauthorized making, manufacture, and possession of certain firearms, including:

- 1) A rifle having a barrel of less than 16 inches in length;
- 2) A weapon made from a rifle if such weapon as modified has an overall length of less than 26 inches or a barrel of less than 16 inches in length; and
- 3) A handgun with a secondary vertical fore-grip installed.

Unauthorized possession, making, or manufacture of any NFA-regulated firearm is a felony under the NFA and may also be illegal under state or local law.

**All users should familiarize themselves with and comply with all federal, state, and local laws and regulations regarding the possession and use of firearms.**

## OPERATION OF SAFETY

The RUGER® 22 CHARGER™ pistol has a cross-button safety which is located in the forward portion of the trigger guard (see Figure 1, p. 8). The safety can be engaged only when the hammer is cocked.

The safety is “on” when it protrudes fully from the right side (the bolt handle side) of the trigger guard assembly, as shown in Figure 1, p. 8. In this position the sear is blocked, and the firearm cannot be fired from a normal pull of the trigger.

The safety should always be in the “on” (safe) position except when the shooter is actually firing the firearm. The safety should be moved to the “on” position whenever the shooter ceases firing, even temporarily.

The safety is “off” (fire) when it protrudes from the left side of the trigger guard assembly, as shown in Figure 4. When the safety is off, the red band shows on the safety button. Do not totally rely on the appearance of the red band to indicate that the safety is off. In poor light or if dirt is present, the red band may not be visible. If the safety is “off” and the trigger is pulled, the pistol will fire.

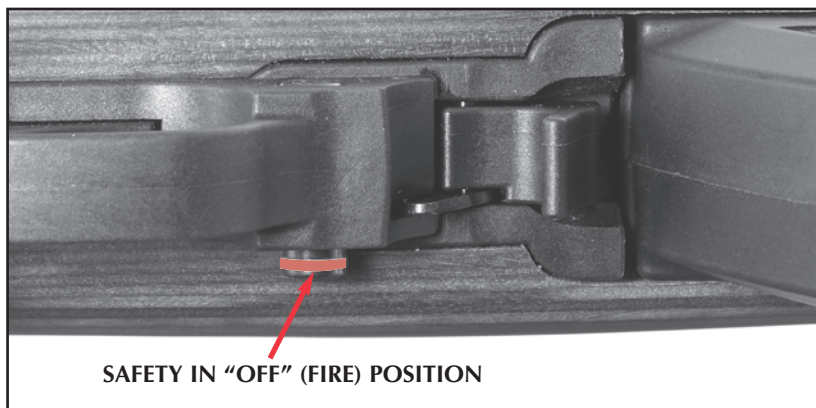

**Figure 4.** The underside of the trigger guard section of the pistol. In this illustration the safety is shown in the “off” (fire) position. The position of the safety and red band indicate the safety is “off.” It should be in this position only when you are actually firing at a target.

The safety is held in its “on” or “off” position by a plunger that is under spring tension. When the safety is moved to either the “on” or “off” position, a distinct “click” should be heard. Frequently check the position of the safety to be certain the safety has not been inadvertently moved. If the safety seems to move too easily, or if the click is not heard when the safety is moved, stop using the pistol and return it to the Newport Customer Service Department for repair (see p. 34).



## WARNING – MANUAL SAFETY



Keep the safety on unless actually firing. Always move the safety fully to its intended position and check it. The safety is not “ON” unless it is completely “ON”. Never depend on a safety mechanism or any other mechanical device to justify careless handling or permitting the pistol to point in an unsafe direction. The only “safe” pistol is one in which the bolt is open, the chamber is empty, and there is no magazine in the firearm.

### KNOW HOW TO USE THE SAFETY

## THE BOLT LOCK

The bolt lock is located in front of the trigger guard (see Figure 1, p. 8). The bolt lock is the manually operated means of retaining the bolt in the rearward (open) position. When the bolt is locked open, the pistol is in an inoperative safe condition for inspection of the chamber, cleaning, etc.

**To lock the bolt open:** Retract the bolt handle to its extreme rearward position and, while holding it there, press in on the lower section of the bolt lock (see Figure 5a). Release pressure on the bolt handle and it will move forward a fraction of an inch, and then be locked in its open position.

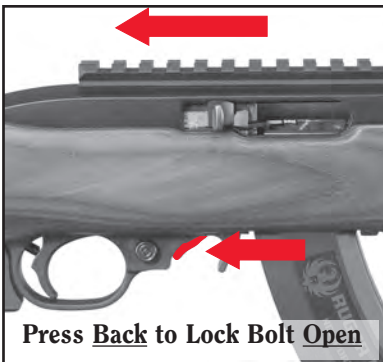

Figure 5a

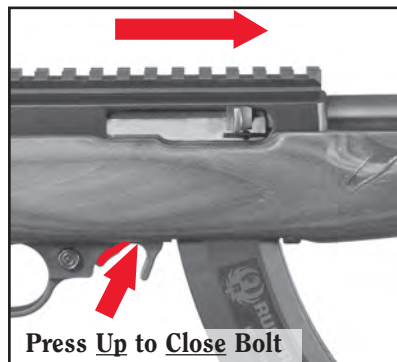

Figure 5b

**To release the bolt:** Retract the bolt handle to its extreme rearward position and then press in on the upper section of the bolt lock (see Figure 5b). Release the bolt and it will move fully forward.

**NOTE:** Simply retracting the bolt will not disengage the lock. The bolt lock must be deliberately pressed up while the bolt is held fully to the rear. Only then will the bolt close when released. This is designed to prevent accidental release of the bolt from its open position.

# 22 CHARGER™ TAKEDOWN

(TAKEDOWN AND TAKEDOWN LITE MODELS ONLY)

## BARREL ASSEMBLY INSTRUCTIONS

The RUGER® 22 CHARGER™ TAKEDOWN pistol has an adjustable lock-up mechanism. The following directions describe the adjustment necessary to ensure proper lockup the first time the barrel is installed. After the first adjustment, the barrel may be installed by following steps 1 and 3 **only**, and the barrel may be removed by following steps 1 and 5 **only**.

1. Remove the magazine, lock the bolt open (see page 14), and verify the pistol is unloaded by visually inspecting the chamber.
2. Loosen the adjustment knob by turning it **clockwise** as far as possible with finger pressure. (See Figures 6a & 6b.)

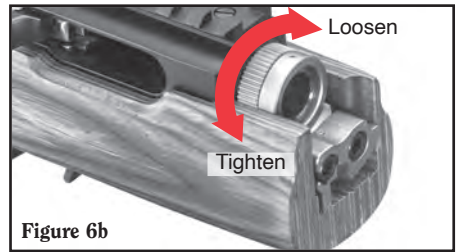
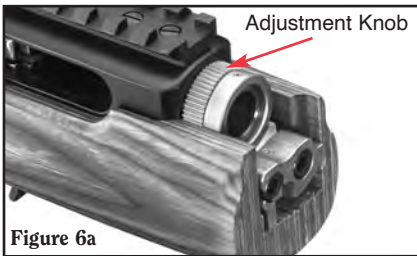

## INSTALLING THE BARREL ASSEMBLY

3. Install the barrel assembly by:

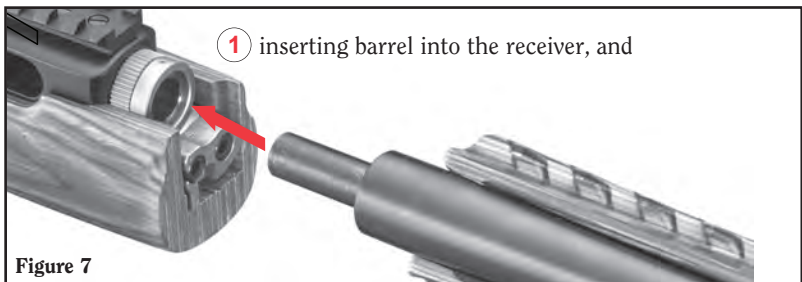

4. Tighten the adjustment knob by turning it **counterclockwise** as far as possible with finger pressure.

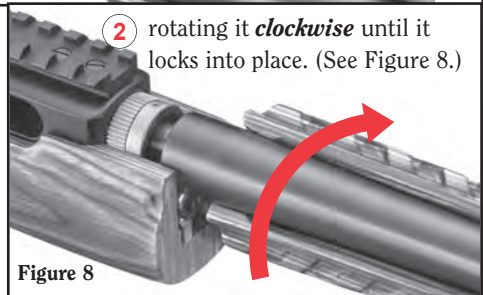

## REMOVING THE BARREL ASSEMBLY

5. To remove the barrel assembly:

- 1 lock the bolt back and
- 2 push the locking lever towards the muzzle and hold it in this position. Next,
- 3 rotate the barrel assembly **counterclockwise**, and
- 4 pull the barrel assembly out of the receiver. (See Figure 9.)

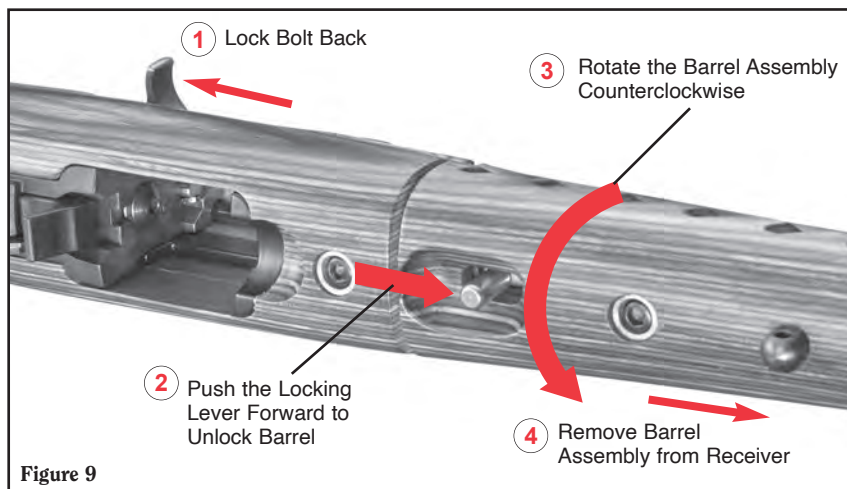

6. Tighten the adjustment knob by rotating it counterclockwise one or two (1 - 2) more clicks.
7. Reinstall the barrel assembly. You should feel some resistance when turning the barrel assembly, but it should not be difficult. If further adjustment is needed, remove the barrel assembly and “tighten” or “loosen” the adjustment knob accordingly.



**NOTE:** Following barrel installation, best first shot accuracy will be achieved if the action is dry-cycled prior to actually firing ammunition in the pistol. Remove the magazine from the pistol and be certain the chamber is empty. Keeping the pistol pointed in a safe direction, pull the bolt handle fully to the rear while holding the bolt lock up, then release the bolt handle, letting it “slingshot” (freely fly forward) into the ready-to-fire position. Repeat 2 - 3 times. This will properly “seat” the barrel assembly.



# AMMUNITION



The RUGER® 22 CHARGER™ pistol is chambered for, and designed to properly function with, only the .22 caliber Long Rifle rimfire cartridge, standard, high velocity, or hyper-velocity, manufactured to U.S. industry standards.

Do not use .22 short, .22 long, .22 shot, or .22 cartridges loaded with blunt-nosed, sharp-shouldered, or “explosive” bullets. They will not function reliably and may jam the mechanism or discharge before being fully chambered. Use only ammunition that functions correctly in your pistol. See “Warning – Malfunctions,” p. 25.

 <b>WARNING – AMMUNITION</b>	
	<p>Use only new, factory ammunition of the correct caliber.</p> <p>Death, serious injury, and damage can result from the wrong ammunition, bore obstructions, powder overloads or incorrect cartridge components. 22 cases are very thin and sometimes split when fired.</p> <p>Always wear shooting glasses and hearing protection.</p>
	<b>IMPROPER AMMUNITION DESTROYS FIREARMS</b>

## AMMUNITION (CARTRIDGES) NOTICE

WE SPECIFICALLY DISCLAIM RESPONSIBILITY FOR ANY DAMAGE OR INJURY WHATSOEVER OCCURRING IN CONNECTION WITH, OR AS A RESULT OF, THE USE IN ANY RUGER FIREARMS OF FAULTY OR NON-STANDARD OR “REMANUFACTURED” OR HAND-LOADED (RELOADED) AMMUNITION OR OF CARTRIDGES OTHER THAN THOSE FOR WHICH THE FIREARM WAS ORIGINALLY CHAMBERED.

 <b>WARNING - LEAD EXPOSURE</b>	
	<p>Discharging firearms in poorly ventilated areas, cleaning firearms, or handling ammunition may result in exposure to lead and other substances known to the State of California to cause birth defects, reproductive harm, and other serious physical injury. Have adequate ventilation at all times. Wash hands thoroughly after exposure.</p>
	<b>SHOOTING OR CLEANING FIREARMS MAY EXPOSE YOU TO LEAD</b>

# MAGAZINES

The RUGER® 22 CHARGER™ pistol is compatible with all RUGER® 10/22® Carbine magazines, including BX-1, BX-15, and BX-25 magazines. Use only high-quality magazines which are clean and in good working order. Magazines that have been tested and approved for use with the RUGER® 22 CHARGER™ pistol are available through Ruger® Accessories sales Monday through Friday, 8:00 a.m. - 5:00 p.m. ET at 1-336-949-5200 or 24 hours a day, 7 days a week at [ShopRuger.com](http://ShopRuger.com).

Do not attempt to use standard 10/22® or 22 CHARGER™ pistol magazines in the 10/22® Magnum or 17 HMR rifles. Do not load .22 short, long, or long rifle ammunition into the .22 magnum or 17 HMR magazine. They will not function correctly and are unsafe to use in .22 Magnum and .17 HMR rifles.

Ruger Long Rifle Magazine (BX-15™)  
for 22 CHARGER™



Do Not Use in Ruger® 10/22® Magnum  
or 10/17 Rifles

Never attempt to use .22 Long Rifle ammunition in Ruger® 10/22® Magnum or 10/17 rifle magazines. The cartridges have a smaller case diameter and can split or burst when fired in the larger magnum chamber, releasing hot powder gasses and particle fragments out of the action at high speed, possibly resulting in injury to the shooter or bystanders.

**DAMAGED, NON-STANDARD, OR IMPROPERLY ASSEMBLED  
MAGAZINES SHOULD NOT BE USED.  
THEY CAN CAUSE THE PISTOL TO MALFUNCTION.**

## LOADING THE MAGAZINE

To load the magazine, press the rim of the cartridge against the magazine rotor at the widest section of the magazine throat until the cartridge enters far enough to be pushed to the rear end of the magazine. Each succeeding cartridge is pressed against the body of the top cartridge and slid to the rear of the magazine until maximum magazine capacity has been reached.



## TO LOAD AND FIRE (WITH MAGAZINE)

Practice this important aspect of firearm handling with an unloaded pistol until you can perform each of the steps – described below – with skill and confidence. But before you do anything with the pistol, please first read completely through this manual.

1. **Keep the muzzle pointed in a safe direction.** (See Rule 2, p. 39.)
2. Engage the safety if the hammer is cocked. Remove the magazine by using your index finger to push forward on the magazine release (Figure 10a) and at the same time grasp the magazine between thumb and forefinger of the other hand to draw it out of the magazine well. (See Figure 10b.)



**Figure 10.** The safety should be “on” when the magazine is being removed or inserted. Move the magazine release forward (Figure 10a) and draw the magazine out by grasping it between your thumb and forefinger and draw it out of the firearm (Figure 10b).

3. Pull the bolt handle rearward. Engage the bolt lock so that the bolt is held open. (See p. 14.) Check the chamber to be certain it is empty. Engage the safety if not already engaged. (See Figure 1, p. 8.)

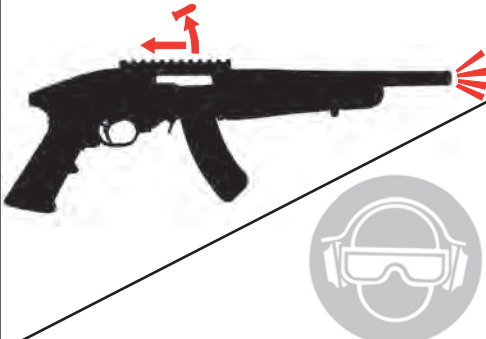

4. Load the magazine with the appropriate number of cartridges (see “Loading The Magazine” section, p. 19).
5. Insert the magazine into the firearm, with bullet end of the cartridges toward the muzzle. (Magazine cannot be seated if reversed.)
6. Load a cartridge into the chamber by fully retracting the bolt handle, releasing the bolt lock, and then releasing the bolt handle. **Do not touch the trigger.** The pistol is ready to fire at this point. Do not ‘ride’ the bolt handle as it moves forward. Do not apply force to the bolt handle to chamber a cartridge. If a cartridge does not readily chamber, engage the safety, remove the magazine, eject the cartridge from the pistol, lock the bolt open, and see “Warning – Malfunctions,” p. 25.
7. The pistol is now fully loaded. **If the pistol is not to be fired immediately, the safety should remain “ON”.** (See Figure 1, p. 8.) When the safety is moved to the “off” position, the pistol will fire each time the trigger is pulled until all the cartridges in the magazine, and the one in the chamber, have been fired. Firing will automatically reload and recock the pistol. **Note that every time the trigger is pulled, if a cartridge is in the chamber, the pistol will fire – be careful!**
8. **Immediately following the firing of a shot, and if a subsequent shot is not to be fired at once, put the safety “ON” while the pistol is still pointing in a safe direction down range.** The safety should be moved to the “on” position as soon as firing is completed, and it should be “on” at all times except when the pistol is on target and being fired.
9. The bolt does not remain open after the last shot has been fired, nor does the bolt automatically lock open when the magazine is empty. When firing is completed, manually retract the bolt, lock it open, and visually check the chamber to be sure it is empty. **If the bolt is shut, the shooter should always assume that there is a cartridge in the chamber and the pistol can fire. Do not rely on your memory to know if a firearm or magazine is loaded. Visually inspect the magazine and the chamber.**

 <b>WARNING – FIRING</b>	
	The bolt automatically opens and shuts quickly while firing. Keep face and hands away from it. Hot brass and powder gas are ejected quickly and can burn you. Always wear shooting glasses and hearing protection.
	<b>BOLT OPENS FAST– HOT BRASS EJECTED</b>

 <h2 style="margin: 0;">WARNING – HANDLING</h2>	
	<p>If dropped or struck with the safety “off”, the pistol may fire. Keep chamber empty unless actually firing! Keep safety “on” unless actually firing!</p>
<p><b>ANY FIREARM MAY FIRE IF DROPPED</b></p>	

## TO LOAD AND FIRE (WITHOUT MAGAZINE)

The pistol can be used as a single shot pistol in the absence of a magazine or for safety or training purposes. To do so, follow step 1 through 3, p. 19. Next, carefully place a single cartridge into the chamber. The chamber can be accessed either through the magazine well or ejection port. Retract the bolt handle, release the bolt lock, and then release the bolt handle. The pistol is now loaded. Follow the additional instructions beginning at Step 7, p. 20. Engage the safety between shots.

 <h2 style="margin: 0;">WARNING – UNLOADING</h2>	
	<p>So that the pistol can be used as a single loader, it will fire whether or not a magazine is in the firearm if a cartridge is chambered. Removing magazine does not unload pistol! To unload, first remove magazine, then pull bolt to rear, eject chambered cartridge, and visually inspect chamber. <b>The safety should always be in the “on” (safe) position when loading or unloading the pistol.</b> Keep safety “on”.</p>
<p><b>FIREARM WILL FIRE WITH MAGAZINE OUT</b></p>	

# TO UNLOAD

(PISTOL MUST BE KEPT POINTED IN A SAFE DIRECTION)

UNLOAD THE PISTOL IMMEDIATELY WHEN YOU ARE FINISHED SHOOTING!

**NOTE:** This sequence must be followed exactly as directed. Failure to do so can result in the pistol's chamber becoming unintentionally loaded with a cartridge!

1. Keep the muzzle pointed in a safe direction at all times and keep fingers outside the trigger guard. If the hammer is cocked, move the safety to the "on" position.
2. Remove the magazine. **Remember** that even though the magazine has been removed, a cartridge remaining in the chamber can still be fired!
3. Retract the bolt to its open position and lock it there. This should eject any cartridge in the chamber, but...
4. **Always visually double check the chamber to be certain it is empty.**
5. The only "safe" pistol is one in which the bolt is open and the chamber and magazine are empty.
6. Cartridges can be removed from the magazine by simply pushing them lightly downward and forward with the thumb, forefinger, or the rubber eraser end of a pencil against the rim of the top cartridge. **Do not use a loaded cartridge or other hard instrument as a "tool" to strip cartridges from the magazine.**
7. If desired, the bolt can be left in the open position, being held there by the bolt lock. If you desire to close the bolt, again look to be certain the chamber is empty and there is no magazine in the pistol. Put the safety "on", retract the bolt to its rearmost position, release the bolt lock and let the bolt snap forward. Keep your fingers out of the receiver!
8. **With the muzzle pointed in a safe direction**, push the safety to the "off" position and pull the trigger to decock it. The pistol can be "dry fired" for practice as long as it is empty and pointed in a safe direction.
9. Push empty (unloaded) magazine into the pistol until the catch locks it in place.

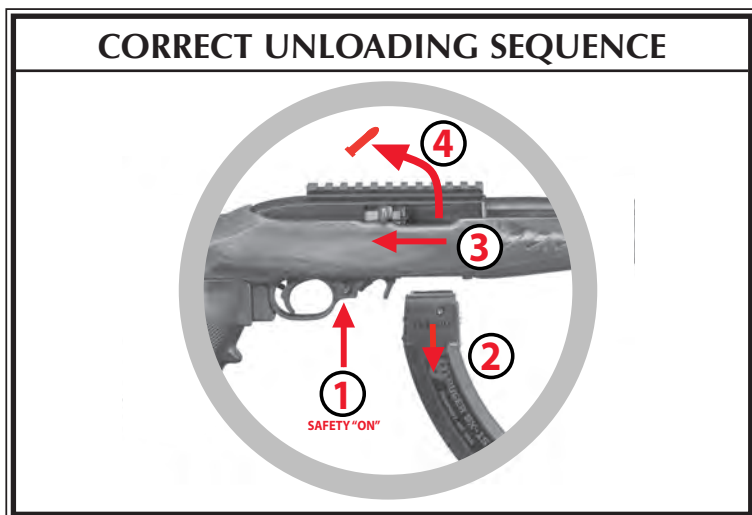

## TO EXTRACT AND EJECT A CHAMBERED CARTRIDGE

When the pistol is fired, the same gas pressure which drives the bullet forward also acts through the cartridge case to push the bolt to the rear. That action causes extraction and ejection of the fired cartridge case. But, when the bolt is operated by hand, there can be a failure to extract the cartridge from the chamber, or a failure to eject the cartridge clear of the pistol. These failures usually are the result of the bolt not being pulled rearward vigorously, coupled with an accumulation of bullet lubricant in the chamber. From the foregoing it is clear that the firearm user must:

1. **Always visually check the chamber after opening the bolt to eject a chambered cartridge.** If the bolt is not vigorously retracted when being operated by hand, the extracted cartridge can be 'ejected' into the magazine area, instead of outside the pistol.
2. Thoroughly clean the chamber and the extractor as often as necessary to prevent the accumulation of grease and dirt.
3. If an empty magazine is in the pistol when the bolt is being hand retracted to extract a cartridge, the cartridge may drop on top of the magazine. Then when the bolt goes forward, the cartridge will be chambered again! **Always remove the magazine before clearing the chamber, and visually ensure that no cartridges remain in the firearm.**

## TO CLEAR A MALFUNCTION ("JAM" OR "MISFIRE")

1. **Be certain the muzzle is continually pointed in a safe direction and keep fingers out of the trigger guard.**
2. If the misfire is the result of a cartridge not firing or unusual report (either louder or quieter than normal), keep the pistol pointed in a safe direction for 30 seconds prior to ejecting the chambered round or retracting the bolt.
3. If possible, remove the magazine. It may be necessary to manually remove a jammed cartridge that has only been partially stripped from the magazine. If so, use extreme care. Lock the bolt open with the bolt lock before attempting to clear the jam. Drawing the bolt fully to the rear may bring the jammed cartridge along. **Keep your face away from the ejection port during this operation.** When attempting to clear a jam, use only wood "tools" so that the cartridge will not be damaged or the primer ignited. A 3/16" wooden dowel with a point on one end is useful.
4. Visually check to make sure that all cartridges have been removed from the pistol. Safely dispose of any cartridges involved in a malfunction incident. **Do not use damaged ammunition in any firearm.**
5. Inspect the bore and chamber to ensure that they are not obstructed. **Failure to detect and correctly remove a bore obstruction can result in serious injury!**

## TO MINIMIZE MALFUNCTIONS ("JAMS" OR "MISFIRES")

Most malfunctions are caused by improper or damaged magazines, incorrect ammunition, or poor maintenance.

1. If it appears that the firearm and magazine are not at fault and that the jam was caused by the type of cartridge being used, then try another type.
2. If changing to another type or brand of cartridges does not at once eliminate malfunctioning, then the following steps should be taken:
  - a. **Make certain the firearm and the magazine are unloaded and that the safety is "on." Remember, the magazine should be removed first, then check the chamber and be certain it and the magazine well are clear of cartridges.**
  - b. Thoroughly clean the magazine (See "Magazine Inspection and Care," p. 29) and bolt mechanism, paying particular attention to removing accumulated grease. Use a bristle brush and solvent to remove grease and fouling from the bolt face, the extractor, the chamber, and the feed ramp. (See the "Care and Cleaning" section of this manual for detailed cleaning instructions.)
  - c. Check to see that the magazine spring tension is adequate and the magazine follower travels freely without binding.
  - d. Check the magazine feed lips to be certain they are free of nicks and burrs and are not deformed.
  - e. Remove excess oil and solvent from all cleaned components, load the magazine, and try the firearm again. As always, proceed slowly. **Be certain bystanders are not close and that you are wearing eye and hearing protection and that your face is a safe distance from the pistol so that any discharge resulting from a jammed cartridge will not injure anyone.**

If the above procedures do not result in a smooth and reliably functioning firearm, don't use the firearm. The pistol can be returned directly to our Newport, New Hampshire Customer Service Department for repair. See the Service and Parts Policy section (p. 34) of this manual for packing and shipping information.

**Another precaution:** When using any firearm chambered for rimfire cartridges, form the habit of examining fired cartridge cases. If they have bulged heads or frequently show splits on any part of the case, the firearm should be returned to the factory for inspection.





## WARNING – MALFUNCTIONS



.22 Long Rifle rimfire cartridges fire when the firing pin impacts the relatively soft cartridge case rim, and also can be “discharged” before it is chambered if its rim receives a sharp blow. If a cartridge hangs up, jams, or binds when being chambered or when being fed from the magazine into the chamber, **do not attempt to force it into the chamber by pushing or striking the bolt.** Any jam or feeding problem is a signal to immediately stop using the firearm until it can be determined what is wrong. Most failures of a cartridge to feed or to chamber are caused by a damaged magazine, improper firearm handling, poor maintenance, improper or defective ammunition. **Whatever the cause, rimfire cartridge jams can result in the potentially dangerous situation of a cartridge discharging before it is chambered. If this occurs, the cartridge case will rupture and its fragments will fly out of the firearm with sufficient force to cause injury. Always wear shooting glasses and hearing protectors! Keep face away from chamber!**



**CRUSHING RIM CAN BURST AMMO**



## WARNING – BORE OBSTRUCTIONS



Before loading or shooting your RUGER® 22 CHARGER™ pistol, be certain the bore is unobstructed. *Firing the pistol with any obstruction in the bore may result in severe damage to the pistol and serious injury to the shooter and other persons nearby.*

A MISFIRE or unusual report (sound) upon firing is always a signal to cease firing immediately. After waiting for one minute, remove the magazine, lock the bolt open, and ensure that the chamber is empty. It is not sufficient to only examine the chamber in these instances. You must - with a rod if necessary - visually inspect the bore to be certain it is completely clear of any obstruction. Failure to detect and correctly remove a bore obstruction can result in serious injury to the shooter and bystanders, and damage to the firearms.

**DO NOT “SHOOT OUT”  
A BORE OBSTRUCTION**



## WARNING – DISASSEMBLY



Always unload a firearm before cleaning, lubrication, disassembly or assembly.

**UNLOAD BEFORE  
CLEANING**

## DISASSEMBLY

**MAKE SURE PISTOL IS UNLOADED!**

1. With the pistol pointed in a safe direction, engage the safety (if the hammer is cocked), remove the magazine, fully retract the bolt and visually make certain there is not a cartridge in the chamber. Then allow the bolt to close. The hammer should be cocked.
2. If you have a standard RUGER® 22 CHARGER™ pistol (not the takedown model), loosen (do not remove) the takedown screw. For 22 CHARGER™ Takedown models, first follow the “Removing the Barrel Assembly” instructions on page 16 and then loosen (do not remove) the takedown screw from the receiver assembly portion of the pistol.
3. Position the safety so an equal amount of the button is exposed on each side. If the safety is not in the middle when the receiver assembly is lifted out of the stock, the stock will be damaged.
4. Swing the receiver assembly upward away from the forearm of the stock. Be careful the two receiver cross pins and bolt stop pin do not fall out.
5. Remove the trigger guard by simply drifting out the two receiver cross pins. It is recommended that the components of the trigger guard assembly not be disassembled from the trigger guard.

This is the extent of disassembly required for routine inspection, cleaning and lubrication.

If it is desired to thoroughly clean the inside of the receiver by removing the bolt, be aware that although removing and installing the bolt (along with the bolt handle-recoil spring assembly) is simple, it must be done correctly.

6. To remove the bolt:
  - a. Position the receiver upside down so the bolt is fully accessible.
  - b. Drift out the bolt stop pin, located at the rear of the receiver.
  - c. Pull the bolt handle fully to the rear of the receiver with the left hand, and while holding it in that position, using the right hand, lift up the front of the bolt until it is disengaged from the bolt handle.
  - d. Remove the bolt handle assembly through the ejection port.
  - e. Lift the bolt out of receiver. If it does not come out readily, turn the receiver over and the bolt will drop out of the receiver.

## REASSEMBLY

**AGAIN, BE SURE THE PISTOL IS UNLOADED!**

### 1. Reassembly of bolt into receiver:

- a. To reassemble bolt handle and bolt in the receiver, position the rear end (cone pointed) of the recoil spring guide rod in the mating recess near the rear right side of the receiver. The recoil spring must be flat against the side and “bottom” of the receiver.
- b. Maintain the guide rod in its proper position by keeping pressure on the bolt handle with the left forefinger and thumb. At the same time, use the flat side of the screwdriver blade to compress the recoil spring by drawing it against the area of the bolt handle near the spring. In accomplishing this spring compression it is necessary to maintain the same pressure on the screwdriver with the right hand as that being maintained (rearward and inward) on the bolt handle with the left hand.
- c. When the spring is fully compressed, maintain it in that position with the left hand and with the right hand lay the recessed section of the top of the bolt on the section of the bolt handle that mates with it. Press down on the bolt until a ‘click’ is heard. At this point allow the bolt handle (with bolt attached) to move forward slowly.
- d. Cycle the bolt handle a few times to be certain the components are correctly assembled.

### 2. Reassembly of pistol:

- a. Install the bolt stop pin and then lay the trigger guard in place and install the two receiver pins.
- b. Assemble the receiver to the stock by following, in reverse order, steps 1 through 5 under the “Disassembly” instructions on page 26.

**Firearms should not be stored loaded or cocked!**

# CHECK YOUR PISTOL'S FUNCTION

Periodic inspection of any firearm is important to ensuring its safe operation. It is important to clean and inspect your firearm after each range session or whenever the firearm has been exposed to sand, dust, moisture, humidity, or other adverse conditions. Proper maintenance increases the longevity of your firearm and will allow early detection of worn or broken parts.

Prior to each use, visually inspect the firearm to ensure no components are damaged, missing, loose, bent, cracked, chipped, or peened. If you observe excessive wear, you should stop using your pistol and contact customer service or a trained certified gunsmith to evaluate its condition and replace any worn parts if necessary.

After any disassembly and reassembly, it is important to verify that the action is working correctly before any live firing is attempted.

**FIRST, BE SURE THERE IS NO AMMUNITION IN THE CHAMBER OR THE MAGAZINE AND KEEP THE PISTOL POINTED IN A SAFE DIRECTION!**

- a. CHECK THE BOLT FUNCTION: Pull the bolt fully to the rear and release it. The bolt should operate smoothly and travel freely within the receiver without binding. Repeat this process two more times.
- b. CHECK THE SAFETY FUNCTION: **NOTE:** When the safety is moved to either the “on” or “off” position, a distinct “click” should be heard. If the safety seems to move too easily, or if the click is not heard when the safety is moved, stop using the pistol and contact Ruger Customer Service at 336-949-5200. For additional information regarding the safety, please refer to the “Operation of Safety” section of this manual.
  - First, pull the bolt fully to the rear and release it. This should cock the hammer. Do not dry fire the pistol.
  - Next, engage the safety by pushing it into the “on” position and attempt to pull the trigger. With the safety in this position, the trigger should not move and the hammer should not fall.
  - Finally, move the safety to the “off” position. With the pistol pointed in a safe direction, pull the trigger and listen for an audible “click” as an indication the hammer has fallen, striking the firing pin.

Repeat this process two more times.

- c. CHECK THE BOLT LOCK FUNCTION:
  - First, retract the bolt handle to its extreme rearward position and, while holding it there, press in on the lower section of the bolt lock.
  - Next, release pressure on the bolt handle. The bolt should move forward a fraction of an inch, and then be locked in its open position.
  - Finally, retract the bolt handle to its extreme rearward position and then press in on the upper section of the bolt lock. Release the bolt and it should move fully forward.

An on-line video demonstrating the disassembly, reassembly, and function check of the RUGER® 22 CHARGER™ pistol can be viewed by going to [Ruger.com/TechTips](http://Ruger.com/TechTips).

If any of the above function checks fail or if you are uncertain, please consult a competent gunsmith or contact Ruger Customer Service at 336-949-5200 for further firearm inspection **before using the firearm.**

# MAGAZINE INSPECTION AND CARE

When cleaning is necessary, use a solvent that will not rust the metal components or adversely affect the plastic magazine box. After the magazine has been soaked in solvent to loosen foreign matter, be certain to shake it vigorously (with the loading opening away from you) to remove solvent or residue from within the magazine.

After cleaning, always check to be certain that follower movement and tension are correct, and that no solvent or debris remain. **Do not disassemble the magazine.**

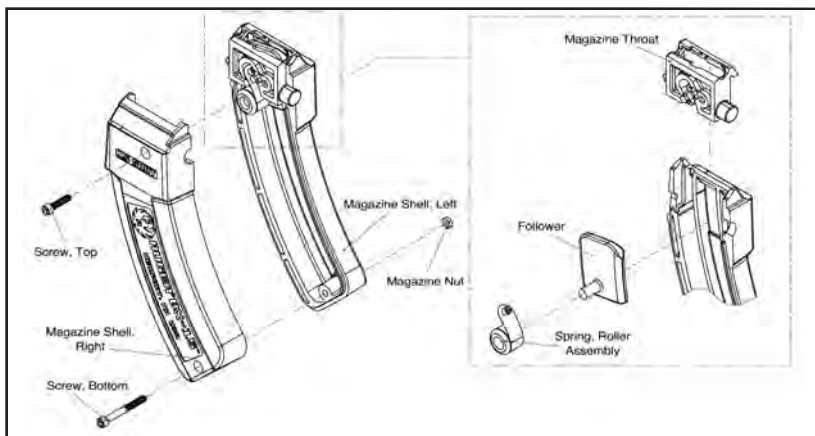

Exploded view of the BX-15 magazine components. This illustration is included to show the relationship and names of the magazine components. As noted in the text above, the magazine should not be disassembled

## CARE AND CLEANING

**MAKE SURE THE PISTOL AND ITS MAGAZINE ARE UNLOADED!**



Before cleaning, be certain the pistol and its magazine contain no cartridges.

Cleanliness is most important to the function of this blow-back operated autoloading firearm. Any failures to feed or extract rounds may be indications of a dirty chamber. Use commercially available bore cleaning solution and a brass brush, followed by drying with a cloth patch, to remove any powder residue. **An excess of dirt, powder residue, or oil in the chamber will cause malfunctions and may result in potentially dangerous cartridge case ruptures and release of hot gasses and case fragments when firing.**

At regular intervals, or whenever the pistol has been exposed to sand, dust, extreme humidity, condensation, immersion in water, or other adverse conditions, disassemble, clean and oil it. Proper periodic maintenance and inspection for worn or damaged parts is essential to the reliable functioning of any firearm.

To clean the pistol, proceed as follows:



1. Disassemble (field-strip) the pistol to the extent described on pages 26 - 27.
2. Using a cleaning rod, run a properly sized, solvent-wetted patch through the bore several times. Then attach a solvent-wetted bristle brush to a cleaning rod and run it back and forth the full length of the bore as many times as necessary to remove grease and dirt from the bore and chamber. Clean bore with dry patches and examine. Bore fouling can contribute to reduced accuracy, and grease accumulation in the chamber can interfere with proper feeding of cartridges from the magazine.
3. Using powder solvent on a clean patch or bristle brush, remove powder residue from all components of the mechanism. After cleaning, run a dry patch through the bore, then follow with a patch that is very lightly oiled. Wipe all surfaces clean with cloth, then wipe all surfaces with a patch or cloth that has been very lightly oiled.
4. **NOTE:** Only a light application of oil is needed to provide adequate lubrication of moving parts and to prevent rust. Excess accumulations of oil tend to attract particles of dust and dirt and may congeal in cold weather which can interfere with the safe and reliable functioning of the pistol.

 <b>WARNING – LUBRICATION</b>	
	<p>Firing a firearm with oil, grease, or any other material even partially obstructing the bore may result in damage to the firearm and serious injury to the shooter and those nearby. Do not spray or apply lubricants directly on ammunition. If the powder of a cartridge is affected by the lubricant, it may not be ignited, but the primer firing may push the bullet into the bore where it may be lodged. Firing a subsequent bullet into the obstructed bore may damage the pistol and cause serious injury or death to the shooter and those nearby. Use lubricants properly. You are responsible for the proper care and maintenance of your firearms.</p>
	<b>IMPROPER LUBRICATION DESTROYS FIREARMS</b>

# THREADED BARREL INFORMATION (ON MODELS SO EQUIPPED)

Some RUGER® 22 CHARGER™ pistols come equipped with a threaded barrel that is protected by a removable muzzle cap. The cap protects the 1/2"-28 threads at the end of the barrel. **Ensure that any muzzle device installed on a 22 CHARGER™ pistol is intended for use on firearms of the correct caliber and thread pitch.**

**NOTE:** RUGER® 22 CHARGER™ TAKEDOWN LITE pistols utilize a barrel nut that is torqued to precise factory specifications to optimize performance. **DO NOT** attempt to tighten or remove the barrel nut. If you have any questions or concerns please contact Ruger Customer Service at 336-949-5200.

 <b>WARNING – BARREL NUT</b>	
 <p><b>DO NOT Remove Barrel Nut</b></p>	<p>When removing the muzzle cap, a barrel nut is behind the cap. This nut is used to lock the barrel in place. This nut should never be loosened, removed or tampered with. This nut is meant to remain in place and should not be removed under any circumstance. Failure to follow this warning will cause permanent damage to your firearm and will not be warranted or repaired by Customer Service.</p>
	<b>DO NOT REMOVE BARREL NUT</b>

## ATTACHING PICATINNY SCOPE BASE RAIL

**NOTE:** The Picatinny Scope Base Rail is attached at the factory.

**To attach the picatinny scope base rail to the pistol receiver:**

1. Remove the magazine, retract the bolt handle, lock the bolt open and push the safety to the “on” position. **Be sure the firearm and chamber are completely unloaded.**
2. Unscrew the four screws from the top of the receiver. These screws may be quite tight.
3. Position the scope base rail on the receiver and check to be sure that all four mounting holes in the scope base rail line up with the four screw holes in the receiver. Place a base-mounting screw in each hole of the scope base rail. Turn each screw until it just catches the threads in the receiver hole, but do not tighten the screws at this point.

4. Starting at the screw closest to the barrel-side of the receiver, turn each screw part way in, then move to the next screw, repeating the procedure until all four screws are snugly tightened.
5. Release the bolt handle, then retract it several times, permitting it to snap forward. If the bolt seems to bind, determine which screw is binding the top of the bolt by slightly unscrewing one screw at a time, checking for binding when each screw is loosened. If it is necessary to shorten a screw, be certain to chamfer its top so it does not cross thread the hole in the receiver.
6. Attach the scope base and scope to the adapter in accordance with its instructions.

**Scope mounting precautions:** Do not remove the scope base filler screws (there are four in the receiver) unless the supplied picatinny scope base rail or other suitable base is to be mounted with properly fitting screws. Do not deepen or alter the screw holes that are in the RUGER® 22 CHARGER™ pistol. Do not place any sealant into the screw holes in the receiver, as the sealant can drip into the bolt or receiver and cause potentially dangerous malfunctions.

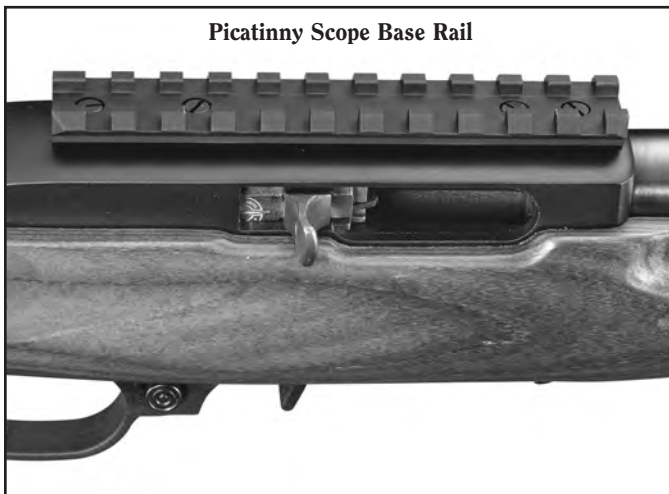





# STORAGE

FIREARMS SHOULD NOT BE STORED LOADED!

USE THE LOCKING DEVICE SUPPLIED WITH THE PISTOL TO RENDER IT INOPERATIVE FOR SAFE STORAGE.  
(SEE PAGE 9)

*Do not* store the pistol in a leather case or scabbard. Leather attracts moisture, even though it may appear to be dry.

 <b>WARNING – STORAGE</b>	
	<ul style="list-style-type: none"><li>• Never place or store any firearm in such a manner that it may be dislodged. Firearms should always be stored securely and unloaded, away from children and careless adults.</li><li>• Use the locking device supplied with the pistol for storage. The use of a locking device or safety lock is only one aspect of responsible firearms storage.</li><li>• For increased safety, firearms should be stored unloaded in a location that is both separate from their ammunition and inaccessible to children and any other unauthorized person.</li></ul>
<b>STORE SECURELY &amp; UNLOADED</b>	

# SERVICE AND PARTS POLICY

If you have any question regarding the performance of your RUGER® 22 CHARGER™ pistol please contact our Customer Service online at [Ruger.com](http://Ruger.com) or call the Customer Service Dept. at 336-949-5200. Fully describe all circumstances and conditions involved. If you should need to return your pistol to the factory for repair, or order parts for it, please comply with the following suggestions for prompt service:



**WARNING: BEFORE SHIPPING ANY FIREARM, BE ABSOLUTELY CERTAIN THAT IT IS UNLOADED. DO NOT SHIP CARTRIDGES WITH A FIREARM.**

## SHIPPING FIREARMS FOR REPAIR

**NOTE:** You must obtain a **Repair Authorization Number** before returning your firearm. An authorization number can be obtained by contacting Customer Service online at [Ruger.com](http://Ruger.com) or calling the Customer Service Department at 336-949-5200. Firearms should be sent prepaid. We will not accept collect shipments. Any RUGER® 22 CHARGER™ pistol returned to the factory for repair should be sent to: Sturm, Ruger & Company, Inc., Customer Service Department, 411 Sunapee Street, Newport, NH 03773.



The Federal Gun Control Act, as well as the laws of most states and localities, do not prohibit an individual (who is not otherwise barred from purchasing or possessing a firearm) from shipping a firearm directly to the manufacturer for repair. However, before you ship your firearm to us, be certain that your state or locality does not have a law or regulation which will prohibit you from receiving the firearm (or any included magazines) from us after repair. If such receipt is prohibited, please have a federally licensed firearms dealer ship the firearm to us. If your firearm is sent to us by a dealer, it will be returned to that dealer after being repaired. If a handgun (pistol or revolver) is shipped by an individual who does not hold a Federal Firearms License, it must be shipped for overnight delivery via U.P.S., Federal Express or other, similar private overnight service.

**NOTE:** Persons who do not hold a Federal Firearms License are prohibited by Federal law from shipping a handgun by U.S. Mail. Handguns mailed in violation of the law may be impounded or confiscated by the Post Office and the non-FFL may be subject to prosecution. Rifles and shotguns may be shipped via U.S. Mail.

Please do not include a firearm cases, slings, telescopic sights, or custom accessories with a firearm being shipped to the factory for service. **DO NOT SEND FIREARM BOXES OR LITERATURE THAT YOU CONSIDER TO BE COLLECTOR'S ITEMS – THESE ARE INVARIABLY DAMAGED OR DESTROYED IN SHIPMENT.** Always insure your shipment.

Enclose a letter which includes your name, address, telephone number, firearm serial number and model, and repair authorization number. Describe in detail the trouble you have experienced with your firearm, or the work you wish to have done. Merely stating that the firearm “needs repair” is inadequate information. Please enclose copies of any previous correspondence.

All work performed is subject to a minimum labor charge and charges for shipping and handling. Most models can be reblued, but custom gunsmithing service or nonstandard alterations are NOT AVAILABLE from Ruger Customer Service Departments. Please contact the Customer Service Department for pricing information. In states that have a magazine capacity limitation, **DO NOT RETURN** so-called “high capacity” magazines as Ruger may not be able to return the magazine to you.

 <b>WARNING – PARTS PURCHASERS</b>	
	<ul style="list-style-type: none"><li>• It is the purchaser's responsibility to be absolutely certain that any parts ordered from the factory are correctly fitted and installed.</li><li>• Firearms are complicated mechanisms and <b>IMPROPER FITTING OF PARTS MAY RESULT IN A DANGEROUS MALFUNCTION, DAMAGE TO THE FIREARM, AND SERIOUS INJURY TO THE SHOOTER AND OTHER PERSONS.</b></li><li>• The purchaser and installer of parts must accept full responsibility for the correct adjustment and functioning of the firearm after such installation.</li></ul>
	<b>PARTS MUST FIT CORRECTLY</b>

## ORDERING PARTS

Please contact the New Hampshire Customer Service Department for parts availability and current prices. All parts ordered for the RUGER® 22 CHARGER™ pistol should be sent to: Sturm, Ruger & Co., Inc., Customer Service Department, 411 Sunapee Street, Newport, New Hampshire 03773, 336-949-5200.

We cannot comply with open account or C.O.D. orders. Payment in full via credit card (Visa or MasterCard only), money order or certified bank check (no personal checks, please) is required before any service will be performed. Please provide your name as it appears on the credit card, the expiration date, and the 3-digit security code. All parts orders are subject to a minimum charge and charges for shipping and handling. Order parts by **Part Name and specify the model and entire serial number** of the firearm for which the parts are being ordered. There is a minimum labor charge plus a shipping and handling charge if the parts are factory fit. All factory fit parts are fit on an exchange basis only. We will not return the replaced parts. Please contact the Customer Service Department for pricing information.

Because the receiver is a serial numbered component, it is defined as a “firearm” by Federal law and is not sold as a separate component.

\*Parts designated by an asterisk must be factory fit. These parts are fit on an exchange basis only. We will not return the replaced parts. We will not return any part that is broken, malfunctioning, badly worn or has been modified. See “Warning — Parts Purchasers,” above.

 <b>WARNING: A firearm containing broken, malfunctioning, or badly worn parts should not be fired.</b>
---

# RUGER® 22 CHARGER™

## PARTS LIST

Design, prices and specifications subject to change without notice.

### SPECIFY MODEL, CALIBER AND SERIAL NO. WHEN ORDERING

(See Exploded View on Page 37)

Key No.	Part Name	Key No.	Part Name
* 1	Barrel	26	Magazine Latch Pivot & Ejector Pin, 2 Req'd
2	Barrel Retainer, V-Block	27	Magazine Latch Plunger
3	Barrel Retainer Screws, 2 Req'd	28	Magazine Latch Plunger Spring
4	Bolt Only	29	Receiver Cross Pin, 2 Req'd
5	Bolt Lock	† 30	Receiver
6	Bolt Lock Spring	* 31	Safety Button
7	Bolt Stop Pin	32	Safety Detent Plunger
8	Cocking Handle, Guide Rod & Recoil Spring Assembly	33	Safety Detent Plunger Spring
9	Disconnecter	34	Picatinny Scope Base Rail
10	Disconnecter Spring	35	Scope Base Screws, 4 Req'd
11	Disconnecter & Trigger Pivot Pin	* 36	Sear
12	Ejector	37	Pistol Grip
13	Extractor	38	Stock
14	Extractor Plunger	39	Grip Screw
15	Extractor Spring	40	Lock Washer
16	Firing Pin	41	Sling Swivel Base
17	Firing Pin Rebound Spring	42	Escutcheon
18	Firing Pin Stop Pin	43	Cross Bolt
* 19	Hammer	44	Grip Mount Lug
20	Hammer Pivot Pin	45	Takedown Screw
21	Hammer Spring	* 46	Trigger
22	Hammer Strut	47	Trigger Guard
23	Hammer Strut Washer	48	Trigger Pivot Pin
24	Magazine, Complete, 15-shot Capacity	49	Trigger Plunger
25	Magazine Latch	50	Trigger Plunger Spring
		51	Thread Protector

\* PARTS SO MARKED MUST BE FACTORY FIT.

† This is a serial-numbered component and is not offered for sale.

# RUGER® 22 CHARGER™

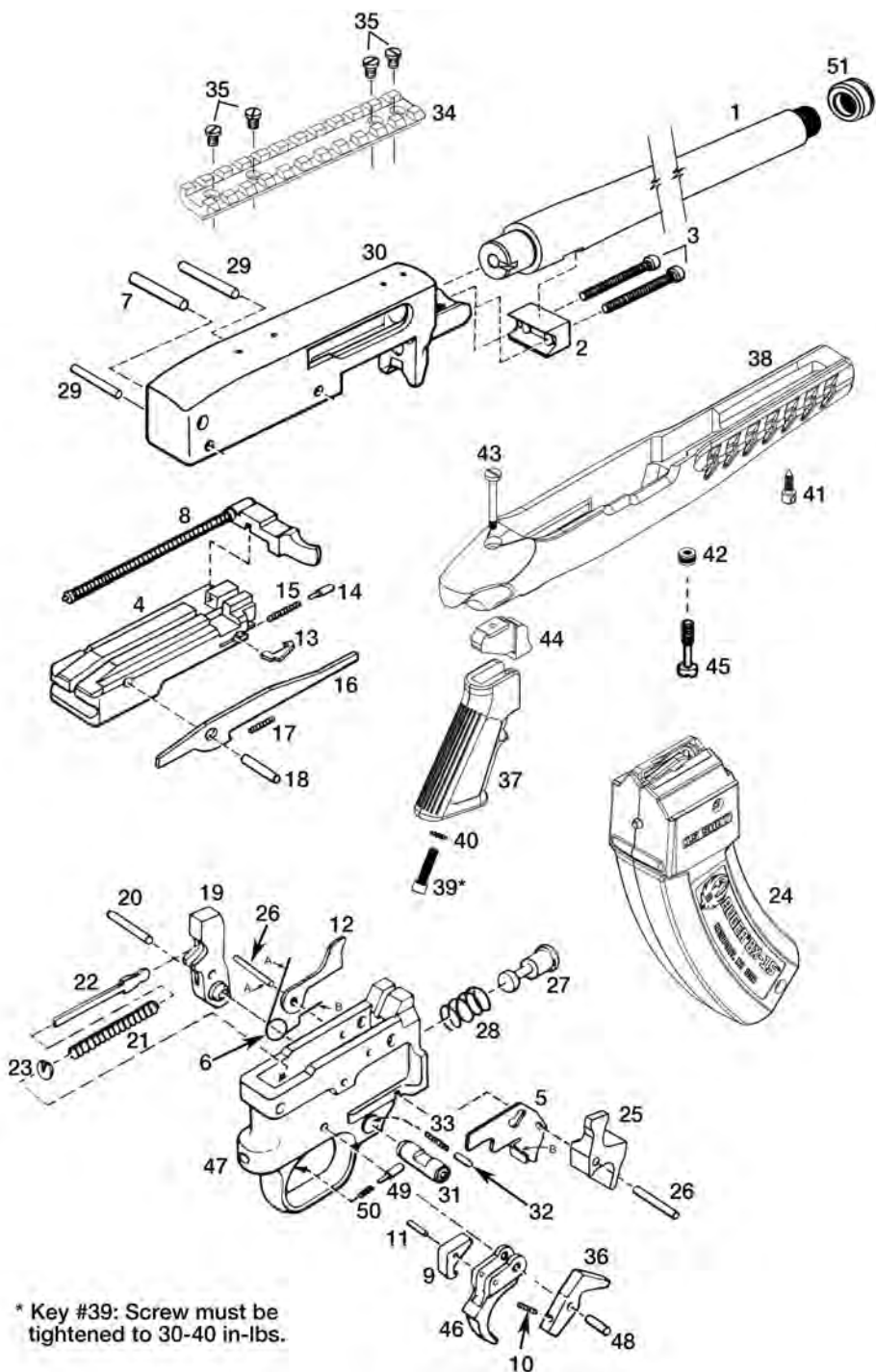

\* Key #39: Screw must be tightened to 30-40 in-lbs.

# RUGER® 22 CHARGER™ TAKEDOWN

## SUPPLEMENTAL PARTS LIST & EXPLODED VIEW

Key No.	Part Name	Key No.	Part Name
1	Buttstock Assembly	15	Mounting Screws, 2 Req'd
† 2	Receiver - Takedown	16	Locking Lever
* 3	Insert	17	Block
4	Detent Spring	18	Stock – Forend
5	Safety Detent Plunger	* 19	Barrel
6	Adjusting Knob	20	Thread Protector
7	Spacer	21	Grip Mount Lug
8	Spacer Pin	22	Pistol Grip
9	Clamp	23	Lock Washer
10	Barrel Retainer Screws, 2 Req'd	24	Grip Screw
11	Takedown Screws, 2 Req'd	25	Cross Bolt
12	Locking Plunger	26	Picatinny Scope Base Rail
13	Locking Plunger Detent	27	Scope Base Screws, 4 Req'd
14	Locking Plunger Spring	28	Brace Mount

\* PARTS SO MARKED MUST BE FACTORY FIT.

† This is a serial-numbered component and is not offered for sale.

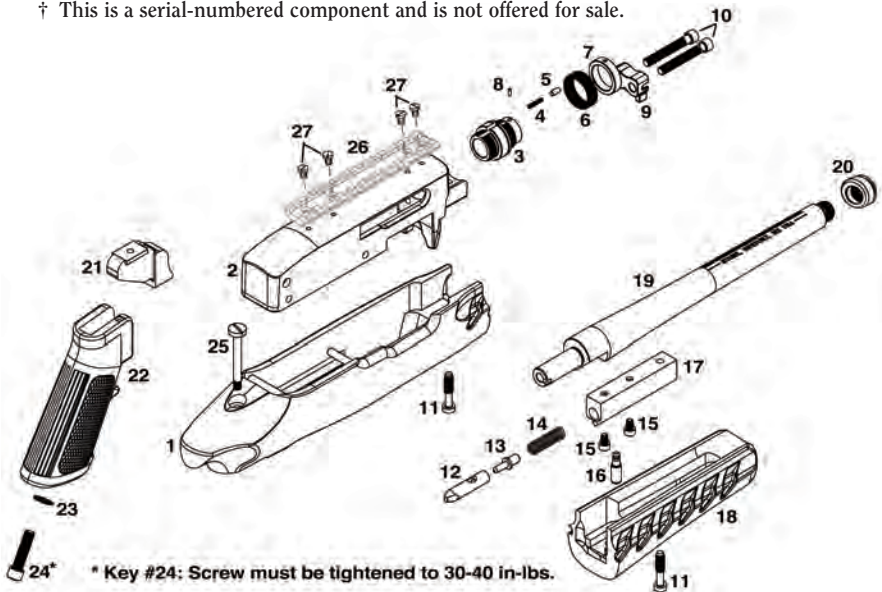

### SUPPLEMENTAL PARTS FOR MODELS WITH BRACE MOUNT

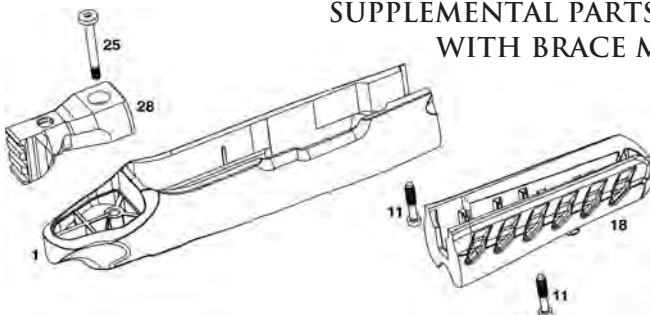

# THE BASIC RULES OF SAFE FIREARMS HANDLING

We believe that Americans have a right to purchase and use firearms for lawful purposes. The private ownership of firearms in America is traditional, but that ownership imposes the responsibility on the gun owner to use his firearms in a way which will ensure his own safety and that of others. When firearms are used in a safe and responsible manner, they are a great source of pleasure and satisfaction, and represent a fundamental part of our personal liberty.

Firearms do not cause accidents! Firearms accidents are almost always found to have been the result of carelessness or ignorance on the part of the shooter of the basic rules of safe gun handling.

The following rules must be observed by gun users at all times. Safe gun handling is not just desirable, it is absolutely essential to your safety, the safety of others, and the continuation of gun ownership and sport shooting as we know it today.

## 1. LEARN THE MECHANICAL AND HANDLING CHARACTERISTICS OF THE FIREARM YOU ARE USING.

Not all firearms are the same. The method of carrying and handling firearms



varies in accordance with the mechanical provisions for avoiding accidental discharge and the various proper procedures for loading and unloading. No person should handle any firearm without first having thoroughly familiarized himself with the particular type of firearm he is using, and with safe gun handling in general.

## 2. ALWAYS KEEP THE MUZZLE POINTED IN A SAFE DIRECTION.



Be sure of the bullet stop behind your target, even when dry-firing. Never let the muzzle of a firearm point at any part of your body or at another person. This is particularly important when loading or unloading a firearm. In the event of an accidental discharge, no injury can occur as long as the muzzle is pointing in a safe direction. A safe direction means a direction that will not permit a discharged bullet to strike a person, or to strike an object from which the bullet may ricochet.

A safe direction must take into account the fact that a bullet may penetrate a wall, ceiling, floor, window, etc., and strike a person or damage property. Make it a habit to know exactly where the muzzle of your gun is pointing whenever you handle it, and be sure that you are always in control of the direction in which the muzzle is pointing, even if you fall or stumble. Keep your finger off the trigger until you are ready to shoot.

### 3. FIREARMS SHOULD BE UNLOADED WHEN NOT IN USE.

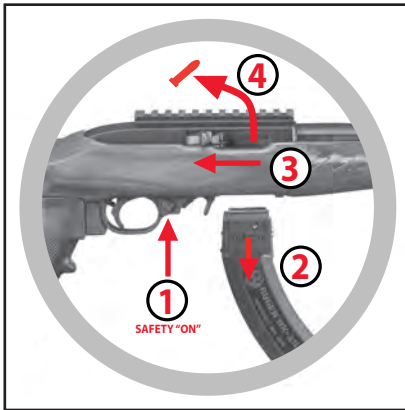

Firearms should be loaded only when you are in the field or on the target range or shooting area, ready to shoot. Firearms and ammunition should be securely locked in safes, racks or cabinets, or by using the locking device supplied with the firearm, when not in use. Ammunition should safely be stored separate from firearms. Store your firearms out of sight of visitors and children. It is the gun owner's responsibility to be certain that children and

persons unfamiliar with firearms cannot gain access to firearms, ammunition, or components.

### 4. BE SURE THE BARREL IS CLEAR OF OBSTRUCTIONS BEFORE SHOOTING.

Even a bit of mud, snow or excess lubricating oil or grease in the bore may cause the barrel to bulge, or even burst on firing, and can cause serious injury to the shooter and bystanders. Be sure that you are using ammunition of the proper caliber and loading for the gun you are using. If the report or recoil on firing seems weak, or doesn't seem quite right, CEASE FIRING IMMEDIATELY, unload your firearm, and check to be sure that no obstruction has become lodged in the barrel. Never try to shoot out an obstruction!

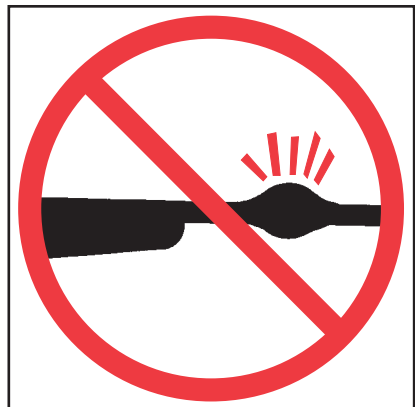





## 5. BE SURE OF YOUR TARGET BEFORE YOU SHOOT.

Don't shoot unless you know exactly where your bullet is going to strike. Be sure of the bullet stop behind your target, even when dry-firing with an unloaded gun. If you are in the field hunting, do not fire at a movement or noise. Take the time to be absolutely certain of your target before you pull the trigger.

## 6. WEAR SHOOTING GLASSES AND HEARING PROTECTION WHEN YOU SHOOT.

All shooters should wear protective shooting glasses and adequate hearing protection when shooting. Exposure to shooting noise can damage hearing, and wearing adequate eye protection when shooting is essential.



## 7. NEVER CLIMB A TREE OR FENCE WITH A LOADED FIREARM.

Put the firearm down carefully before climbing a fence, and unload it before climbing or descending a tree or jumping over a ditch or other obstruction. Never pull or push a loaded firearm toward yourself or another person. When in doubt, or whenever you are about to do anything awkward, unload your gun!

**8. DON'T SHOOT AT A HARD SURFACE OR AT WATER.**

Bullets can glance off many surfaces like rocks or the surface of water and travel in unpredictable directions with considerable velocity.



**9. NEVER TRANSPORT A LOADED FIREARM.**

Firearms should always be unloaded before being placed in a vehicle. A suitable carrying case or scabbard should be used to carry an unloaded firearm to and from the shooting area.

**10. AVOID ALCOHOLIC BEVERAGES WHEN SHOOTING.**

Don't drink until the day's shooting is over. Handling firearms while under the influence of alcohol in any form, or medications that could affect your judgment or coordination, constitutes a criminal disregard for the safety of others.



## A BRIEF ACCOUNT OF AN EXTRAORDINARY ACHIEVEMENT: RUGER® FIREARMS

Sturm, Ruger & Company, Inc., had its beginning in a small machine shop occupying a rented frame building in Southport, Connecticut. In January, 1949, with an initial investment of only \$50,000 and an idea, William B. Ruger and Alexander M. Sturm started production of a .22 caliber autoloading pistol—a design which was so successful that it became the cornerstone upon which one of the most comprehensive lines of sporting firearms ever made in America was established. After Alex Sturm's death in 1951, William B. Ruger continued to direct the Company until his death in 2002. William B. Ruger, Jr. continued to provide guidance, which helped make this Company a sound and successful enterprise, until his retirement in 2006. The Company has continued to prosper, under new management and guidance from our Board, with new products and fresh perspectives.

Ruger, in this relatively short time, has established itself as a leading small arms design organization, developing a unique and broad line of fine quality sporting, military and police firearms to become one of the world's most famous producers of revolvers, pistols, rifles and shotguns. Since 1949, Ruger craftsmen have built many millions of firearms.

During its six decades of growth and progress under the leadership of William B. Ruger, the Company developed a business philosophy and implemented policies which represent a constructive influence in the life of modern America. From the beginning, Ruger played a positive role in conservation efforts and has supported the interests of shooters through such groups as the National Rifle Association, National Shooting Sports Foundation, and many regional sportsmen's organizations.

The Company has always endeavored to market its firearms for constructive and recreational purposes, to emphasize the traditional and responsible aspects of shooting, to render meaningful public services, and to encourage shooters in constructive, responsible, and safe participation in the shooting sports. Its motto, "Arms Makers For Responsible Citizens®," exemplifies this Company philosophy.

Today, Ruger® is particularly mindful of those elements which have contributed to the creation of its success, and extends heartfelt thanks to its many loyal employees and customers.

Instruction manuals for all Ruger® firearms,  
can be downloaded from our website at:

**Ruger.com**

## WHY NO WARRANTY CARD HAS BEEN PACKED WITH THIS NEW RUGER® FIREARM

The Magnuson-Moss Act (Public Law 93-637) does not require any seller or manufacturer of a consumer product to give a written warranty. It does provide that if a written warranty is given, it must be designated as "limited" or as "full" and sets minimum standards for a "full" warranty. Sturm, Ruger & Company, Inc. has elected not to provide any written warranty, either "limited" or "full", rather than to attempt to comply with the provisions of the Magnuson-Moss Act and the regulations issued thereunder. There are certain implied warranties under state law with respect to sales of consumer goods. As the extent and interpretation of these implied warranties varies from state to state, you should refer to your state statutes. Sturm, Ruger & Company wishes to assure its customers of its continued interest in providing service to owners of Ruger® firearms.



**STURM, RUGER & COMPANY, INC.**  
411 SUNAPEE STREET  
NEWPORT, NEW HAMPSHIRE 03773 U.S.A.  
RUGER.COM

**ARMS MAKERS FOR RESPONSIBLE CITIZENS®**

**A COPY OF THE INSTRUCTION MANUAL FOR ANY RUGER®  
FIREARM IS AVAILABLE FROM THE FACTORY FREE ON REQUEST, OR IT MAY BE  
DOWNLOADED FROM OUR WEBSITE AT RUGER.COM.  
THESE INSTRUCTION MANUALS CONTAIN IMPORTANT  
WARNINGS WHICH MUST BE UNDERSTOOD  
BEFORE USING THESE FIREARMS.**

**The Following are Sturm, Ruger & Co., Inc. Trademarks:** "All-Weather," "Bisley," "Gold Label," "I'm a Ruger American," "LC6," "LCR-357," "LC380CA," "Mark II," "Mark III," "Mark IV," "MAX-9," "Model 96," "P345," "P345D," "P345PR," "P85," "P89," "P90," "P91," "P93," "P94," "P95," "P97," "PC Carbine," "R.I.O.S.," "Ruger-5.7," "Ruger Marksman Adjustable," "Ruger 77/50," "Ruger 10/17," "Security-Six," "Service-Six," "77/357," "Single-Seven," "Speed-Six," "SR45," "SR-556C," "SR-556VT," "Super Bearcat," "Target Grey," "10/22-FS," "This is Ruger. This is America," "Tri-Flex," "22 Charger," "22/45," "22/45 RP," and "Your Next Handgun."

**The Following are Registered U.S. Trademarks Belonging to Sturm, Ruger & Co., Inc.:** "AC-556," "AR-556," "Arms Makers For Responsible Citizens," "Bearcat," "Blackhawk," "BX-15," "BX-25," "BX-Trigger," "Eagle - solid logo design, Eagle Hard "R" logo holding gun, Eagle 'R' - soft 'R' & hard 'R' logo design, Eagle w/SR", Eagle w/soft 'R' linear logo design, Eagle w/hard 'R' linear logo design, Eagle w/soft 'R' stacked logo design, Eagle w/hard 'R' stacked logo design, Eagle w/soft 'R' linear logo design & "Rugged, Reliable Firearms" below logo, Eagle w/hard 'R' linear logo design & "Rugged, Reliable Firearms" below logo, "EC9s," "Elite 452," "GP100," "Hawkeye," "It's Mine and It's American," "It's Mine. And It's American," "LC380," "LC9," "LC9s," "LC9s Pro," "LCP," "LCR," "LCRx," "M77," "Match Champion," "Mini-14," "Mini Thirty," "9E," "Old Army," "Power Bedding," "Redhawk," "RUGER," "Ruger American," "Ruger American Pistol," "Ruger American Pistol" flag design, "Ruger American Rifle," "Ruger American Rimfire," "Ruger Custom Shop," "Ruger Hunting" - phrase & logo design, "Ruger Precision," "Ruger Precision Rifle" - phrase & logo design, "Ruger 77/17," "Ruger 77/22," "Ruger 77/44," "Ruger SP101," "Ruger 10/22 Takedown" phrase & logo design, "Ruger Titanium," "Ruger 22/45 Lite," "Ruger Vaquero," "Rugged, Reliable Firearms," "Security-9," "Silent-SR," "Single-Nine," "Single-Six," "Single-Ten," the "SR" Design, "SR9," "SR9c," "SR40," "SR40c," "SR-22," "SR22," "SR-556," "SR-556 Takedown," "SR-762," "SR1911," "Super Redhawk Alaskan," "10/22," & "Wrangler."