

INSTRUCTION MANUAL FOR



RUGER® WRANGLER® SINGLE-ACTION REVOLVER



– RUGGED, RELIABLE FIREARMS® –



**READ THE INSTRUCTIONS AND
WARNINGS IN THIS MANUAL CAREFULLY
BEFORE USING THIS FIREARM**

© 2022 Sturm, Ruger & Co., Inc.

This manual may not be reproduced in whole or in part without the express written permission of Sturm, Ruger & Co., Inc.

**For Service on This Model Please Call:
(336) 949-5200 (See p. 24)**

THIS INSTRUCTION MANUAL SHOULD ALWAYS ACCOMPANY THIS FIREARM AND BE TRANSFERRED WITH IT UPON CHANGE OF OWNERSHIP, OR WHEN THE FIREARM IS LOANED OR PRESENTED TO ANOTHER PERSON

RUGER.COM

WRANGLER / 1-2022 R5

State-By-State Warnings

Certain states require by law that their own specified warning notices in larger-than-normal type be conspicuously included by the manufacturer, distributor or retailer with firearms sold in that state. Sturm, Ruger & Co., Inc. sells its products in compliance with applicable laws and regulations. Because our products may be sold in these states, we include the following:

California:

WARNING

“Firearms must be handled responsibly and securely stored to prevent access by children and other unauthorized users. California has strict laws pertaining to firearms, and you may be fined or imprisoned if you fail to comply with them. Visit the Web site of the California Attorney General at <https://oag.ca.gov/firearms> for information on firearm laws applicable to you and how you can comply.

Prevent child access by always keeping guns locked away and unloaded when not in use. If you keep a loaded firearm where a child obtains and improperly uses it, you may be fined or sent to prison.

If you or someone you know is contemplating suicide, please call the national suicide prevention lifeline at 1-800-273-TALK (8255).”

ADVERTENCIA

“Las armas de fuego deben manipularse de manera responsable y segura para evitar el acceso de niños y otros usuarios no autorizados. California tiene leyes estrictas relacionadas con armas de fuego, y usted puede ser multado o encarcelado si no las cumple. Visite el sitio web del Procurador General de California en <https://oag.ca.gov/firearms> para obtener información sobre las leyes de armas de fuego que le son aplicables y cómo puede cumplirlas.

A los niños los atraen las armas de fuego y las pueden hacer funcionar. Ellos pueden causarse lesiones graves y la muerte. Evite que los niños tengan acceso a las armas de fuego guardándolas siempre con llave y descargadas cuando no las esté utilizando. Si usted tiene un arma de fuego cargada en un lugar en que un niño tiene acceso a ella y la usa indebidamente, le pueden dar una multa o enviarlo a la cárcel.

Si usted o alguien que conoce está pensando en suicidarse, llame a la línea nacional de prevención del suicidio al 1-800-273-TALK (8255).”

Connecticut:

“UNLAWFUL STORAGE OF A LOADED FIREARM MAY RESULT IN IMPRISONMENT OR FINE.”

Florida:

“IT IS UNLAWFUL, AND PUNISHABLE BY IMPRISONMENT AND FINE, FOR ANY ADULT TO STORE OR LEAVE A FIREARM IN ANY PLACE WITHIN THE REACH OR EASY ACCESS OF A MINOR UNDER 18 YEARS OF AGE OR TO KNOWINGLY SELL OR OTHERWISE TRANSFER OWNERSHIP OR POSSESSION OF A FIREARM TO A MINOR OR A PERSON OF UNSOUND MIND.”

Maine:

“ENDANGERING THE WELFARE OF A CHILD IS A CRIME. IF YOU LEAVE A FIREARM AND AMMUNITION WITHIN EASY ACCESS OF A CHILD, YOU MAY BE SUBJECT TO FINE, IMPRISONMENT OR BOTH. KEEP FIREARMS AND AMMUNITION SEPARATE. KEEP FIREARMS AND AMMUNITION LOCKED UP. USE TRIGGER LOCKS.”

Maryland:

“WARNING: Children can operate firearms which may cause death or serious injury. It is a crime to store or leave a loaded firearm in any location where an individual knew or should have known that an unsupervised minor would gain access to the firearm. Store your firearm responsibly!”

Massachusetts:

“WARNING FROM THE MASSACHUSETTS ATTORNEY GENERAL: This handgun is not equipped with a device that fully blocks use by unauthorized users. More than 200,000 firearms like this one are stolen from their owners every year in the United States. In addition, there are more than a thousand suicides each year by younger children and teenagers who get access to firearms. Hundreds more die from accidental discharge. It is likely that many more children sustain serious wounds, or inflict such wounds accidentally on others. In order to limit the chance of such misuse, it is imperative that you keep this weapon locked in a secure place and take other steps necessary to limit the possibility of theft or accident. Failure to take reasonable preventive steps may result in innocent lives being lost, and in some circumstances may result in your liability for these deaths.”

“IT IS UNLAWFUL TO STORE OR KEEP A FIREARM, RIFLE, SHOTGUN OR MACHINE GUN IN ANY PLACE UNLESS THAT WEAPON IS EQUIPPED WITH A TAMPER-RESISTANT SAFETY DEVICE OR IS STORED OR KEPT IN A SECURELY LOCKED CONTAINER.”

New Jersey:

“IT IS A CRIMINAL OFFENSE TO LEAVE A LOADED FIREARM WITHIN EASY ACCESS OF A MINOR.”

New York:

“THE USE OF A LOCKING DEVICE OR SAFETY LOCK IS ONLY ONE ASPECT OF RESPONSIBLE FIREARM STORAGE. FOR INCREASED SAFETY, FIREARMS SHOULD BE STORED UNLOADED AND LOCKED IN A LOCATION THAT IS BOTH SEPARATE FROM THEIR AMMUNITION AND INACCESSIBLE TO CHILDREN AND UNAUTHORIZED PERSONS.”

North Carolina:

“IT IS UNLAWFUL TO STORE OR LEAVE A FIREARM THAT CAN BE DISCHARGED IN A MANNER THAT A REASONABLE PERSON SHOULD KNOW IS ACCESSIBLE TO A MINOR.”

Texas:

“IT IS UNLAWFUL TO STORE, TRANSPORT, OR ABANDON AN UNSECURED FIREARM IN A PLACE WHERE CHILDREN ARE LIKELY TO BE AND CAN OBTAIN ACCESS TO THE FIREARM.”

Wisconsin:

“IF YOU LEAVE A LOADED FIREARM WITHIN THE REACH OR EASY ACCESS OF A CHILD YOU MAY BE FINED OR IMPRISONED OR BOTH IF THE CHILD IMPROPERLY DISCHARGES, POSSESSES, OR EXHIBITS THE FIREARM.”

* * * * *

Please check with your licensed retailer or state police for additional warnings which may be required by local law or regulation. Such regulations change constantly, and local authorities are in the best position to advise you on such legal matters.

FIREARMS SAFETY IS YOUR RESPONSIBILITY
SAFETY MUST BE THE FIRST AND CONSTANT
CONSIDERATION OF EVERY PERSON WHO HANDLES
FIREARMS AND AMMUNITION.

This instruction manual is designed to assist you in learning how to use and care for your RUGER® WRANGLER® revolver properly. Please contact us if you have any questions.

Only when you are certain you fully understand the manual and can properly carry out its instructions should you practice loading, unloading, etc. with live ammunition. If you have any doubts about your ability to handle or use a particular type of firearm safely, you should seek supervised instruction. Such personalized instruction often is available from local firearm retailers, gun clubs or police departments. If none of these sources can help, visit nra.org or write to the following address:

National Rifle Association
11250 Waples Mill Road
Fairfax, VA 22030-7400

The person possessing a firearm has a full-time job. You cannot guess; you cannot forget. You must know how to use your firearm safely. **Do not use any firearm without having a complete understanding of its particular characteristics and safe use.** Remember: There is no such thing as a foolproof firearm.

TABLE OF CONTENTS

Page

State-By-State Warnings	2
New Model Revolver Mechanism	8
Nomenclature	9
External Locking Device Installation Instructions	10
General Information and Mechanical Characteristics	12
Ammunition	13
Handling	14
To Load and Fire	14
To Uncock (Decock) The Revolver	17
To Unload or Eject Cartridge Cases	18
Disassembly	19
Reassembly	20
Check Your Revolver's Function	21
Care and Cleaning	22
Storage	23
Fixed Sights	23
Service and Parts Policy	24
Shipping Firearms For Repair	24
Ordering Parts	25
Parts List	27 - 28
Exploded View	29
The Basic Rules of Safe Firearms Handling	30
Warranty Information	36

“Ruger” is a registered U.S. trademark.



WARNINGS OF GREAT IMPORTANCE ARE FOUND ON THE FOLLOWING PAGES:

Locking Devices	10	Safe Carrying Position	16
Alterations	12	Disassembly	19
Lead Exposure	13	Lubrication	22
Ammunition	14	Storage	23
Handling	14	Shipping	24
Firing	15	Parts Purchasers	25

OTHER CAUTIONS AND WARNINGS APPEAR THROUGHOUT THE MANUAL.

NEW MODEL REVOLVER MECHANISM

The Ruger® single action revolver mechanism is illustrated below. The same basic mechanism is found in the entire line of Ruger® single action revolvers New Model Single Six®, New Model Blackhawk®, New Model Super Blackhawk®, Bisley™, Ruger Vaquero®, Bisley™ Ruger Vaquero®, Hunter Models, and Wrangler® revolver.

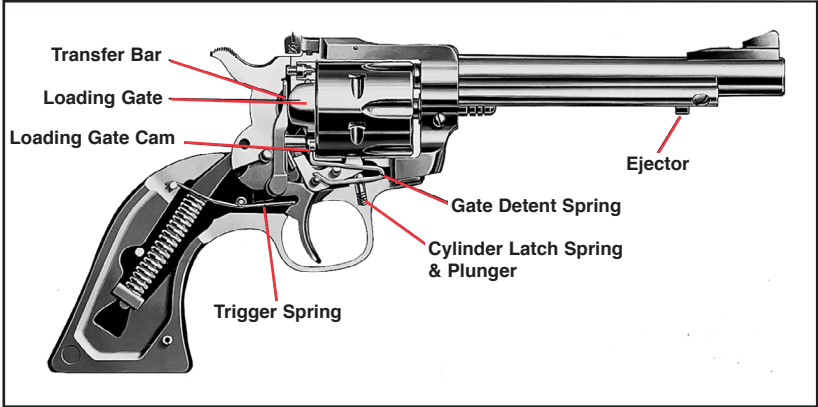

Figure 1. Mechanism shown at rest. Transfer bar is not in line between hammer and firing pin. This is the carrying position.

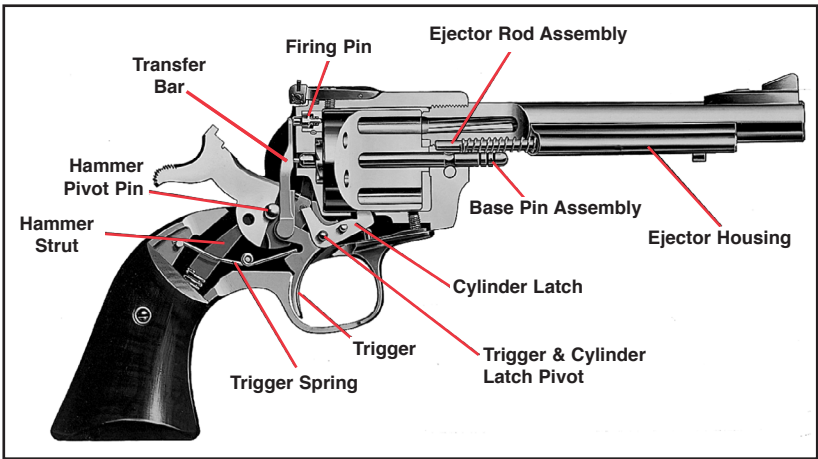
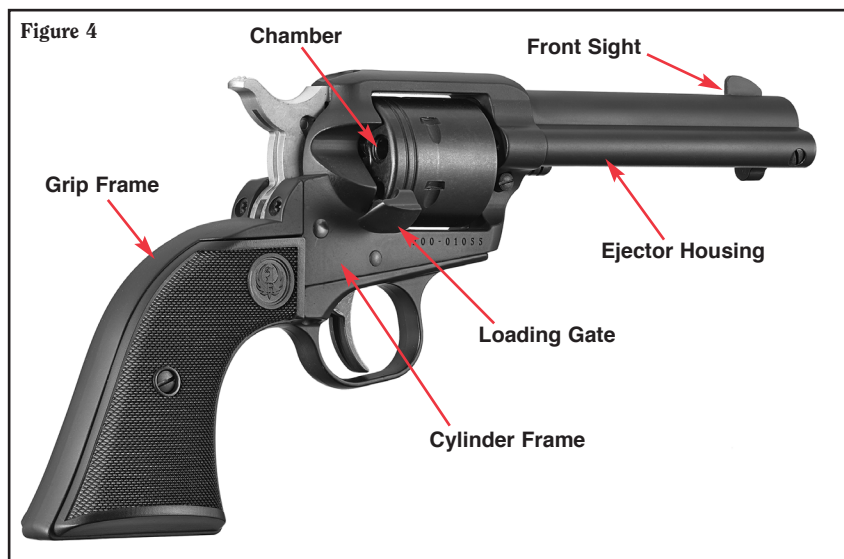
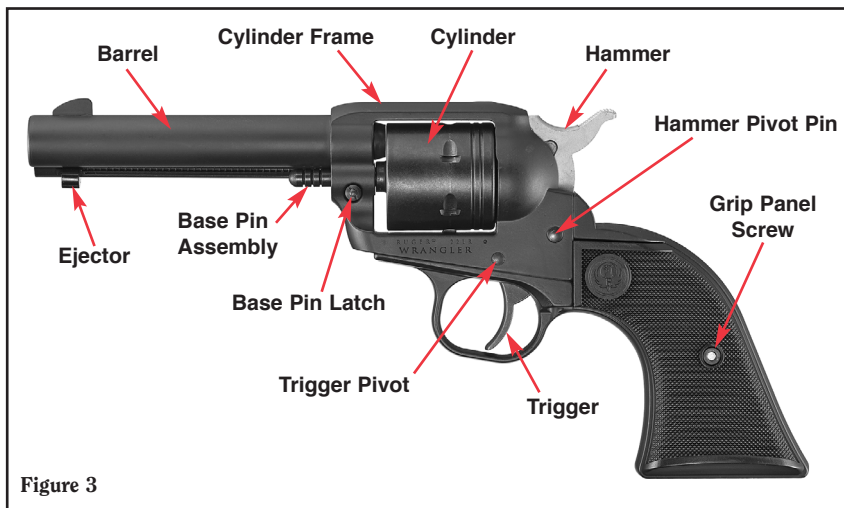

Figure 2. Mechanism shown with trigger pulled and hammer beginning to fall. The transfer bar is in firing position, between the hammer and firing pin.

NOMENCLATURE



PARTS REFERRED TO FREQUENTLY ARE INDICATED BY ARROWS.

EXTERNAL LOCKING DEVICE INSTALLATION INSTRUCTIONS



WARNING – USE OF LOCKING DEVICES



Do not store keys
in lock.

- Always keep your firearm pointed in a safe direction, including when you are installing or removing your locking device.
- Always verify that your firearm is completely **unloaded** before installing your locking device.
- Do **not** install locking devices in the trigger guard unless the instructions specifically require it; otherwise, always keep your fingers and locking device outside the trigger guard during device installation and removal.
- Store firearms, ammunition, and keys separately and securely, away from children and careless adults; do **not** store your firearm with the keys in the locking device.
- Do not attempt to work the action of your firearm with the locking device in place; this may damage your firearm.
- While locking devices are an important aid to security measures, they are not a substitute for safe firearm handling and proper storage. Remember that any mechanical device can be bypassed with enough time, knowledge, determination, and equipment.

**LOCKING DEVICES MUST BE USED
SAFELY AND RESPONSIBLY**

It is important to use the locking device on your Ruger® firearm when the firearm is stored or immediate use is not planned.

Keep the muzzle pointed in a safe direction and your fingers outside the trigger guard at all times!

To Install the Factory-Supplied Locking Device:

1. Be sure the firearm and its cylinder are completely unloaded and contain no cartridges or cartridge cases!
2. Press and hold the base pin latch and completely remove the base pin and cylinder. Refer to the “Disassembly” section on p. 19.

3. Loop the cable through the cylinder frame and trigger guard (behind the trigger) as shown in Figure 5. **Do not insert the cable directly into the trigger guard in front of the trigger! Only insert the cable as shown in Figure 5.**
4. To lock: With the key turned to the farthest clockwise position, insert the loose end of the cable into the padlock. Turn the key counterclockwise and remove the key.
5. Once the lock is securely closed, pull firmly on the lock to test the connection and be sure it is locked. **Do not leave or store your firearm with the key in the lock!** Store your locked, unloaded firearm and the key in secure, separate locations, away from ammunition, children, and unauthorized adults.



Figure 5
Correct installation of the lock on a Ruger® Wrangler® revolver.

**FIREARMS ARE DANGEROUS WEAPONS.
READ THE INSTRUCTIONS AND WARNINGS IN THIS
MANUAL THOROUGHLY AND CAREFULLY BEFORE USING.**

 WARNING—ALTERATIONS	
	This product was designed to function properly in its original condition. Alterations can make it unsafe. Do not alter any part or add or substitute parts not made or sold by Sturm, Ruger & Co., Inc.
	DO NOT ALTER ANY FIREARM

IMPORTANT SAFETY NOTE
OWNERS OF ALL “OLD MODEL” (PRE-1973) RUGER SINGLE-ACTION REVOLVERS, INCLUDING BEARCATS WITH SERIAL NUMBERS BELOW 93-00000, SHOULD WRITE FOR DETAILS CONCERNING OUR FREE SAFETY CONVERSION, WHICH CAN HELP PREVENT ACCIDENTS CAUSED BY A BLOW TO THE HAMMER IF THE USER HAS FAILED TO TAKE THE BASIC SAFETY PRECAUTION OF KEEPING AN EMPTY CHAMBER UNDER THE HAMMER. See Page 26.

GENERAL INFORMATION AND MECHANICAL CHARACTERISTICS



The mechanism of the RUGER® WRANGLER® revolver may differ significantly from other single-action revolvers. The information and instructions which follow apply only to this revolver.

The patented Ruger® New Model mechanism incorporates a transfer bar. The transfer bar – which is raised into firing position as the trigger is pulled to the rear – transmits the energy of the hammer blow to the firing pin. This transfer bar mechanism makes a “safety” notch unnecessary.

The loading gate can be opened only when the hammer and trigger are fully forward. Opening the gate immobilizes the trigger, hammer, and transfer bar. When the gate is opened, the cylinder is unlatched and can be turned for loading or ejection. When the gate is closed, the cylinder latch functions in the normal manner. The loading notch is therefore unnecessary in the New Model design.

Unlike earlier single-action revolver mechanisms which have four hammer positions – “cocked,” “loading,” “safety,” and “all the way forward” – the WRANGLER® revolver has only two hammer positions – “cocked” and “all the way forward.”

The mechanism of the WRANGLER® revolver provides maximum security against accidental discharge. As with any other firearm, however, the WRANGLER® revolver must be used with strict attention to correct safety practices. In addition, the revolver should be inspected frequently to assure that it is working properly.

	
WARNING - LEAD EXPOSURE	
	Discharging firearms in poorly ventilated areas, cleaning firearms, or handling ammunition may result in exposure to lead and other substances known to the State of California to cause birth defects, reproductive harm, and other serious physical injury. Have adequate ventilation at all times. Wash hands thoroughly after exposure.
SHOOTING OR CLEANING FIREARMS MAY EXPOSE YOU TO LEAD	



AMMUNITION

The WRANGLER® revolver is chambered for the .22 Long Rifle cartridge and is intended to be used with any .22 Long Rifle, .22 Long, or .22 Short ammunition, in subsonic, standard, high velocity, or hyper velocity, so long as the ammunition is manufactured to U.S. Industry Standards.

Do Not attempt to use other single-action cylinders in the WRANGLER® revolver.

AMMUNITION (CARTRIDGES) NOTICE

WE SPECIFICALLY DISCLAIM RESPONSIBILITY FOR ANY DAMAGE OR INJURY WHATSOEVER OCCURRING IN CONNECTION WITH, OR AS THE RESULT OF, THE USE IN RUGER REVOLVERS OF FAULTY OR NONSTANDARD OR “REMANUFACTURED” OR HANDLOADED (RELOADED) AMMUNITION, OR OF CARTRIDGES OTHER THAN THOSE FOR WHICH THE FIREARM WAS ORIGINALLY CHAMBERED.

 <h2 style="margin: 0;">WARNING – AMMUNITION</h2>	
	<p>Use only new, factory ammunition of the correct caliber.</p> <p>Death, serious injury, and damage can result from the wrong ammunition, bore obstructions, powder overloads or incorrect cartridge components.</p> <p><u>Always</u> wear shooting glasses and hearing protection.</p>
<h3 style="margin: 0;">IMPROPER AMMUNITION DESTROYS FIREARMS</h3>	

HANDLING

Unlike “old model” single action revolvers, which should always be carried with the hammer down on an empty chamber to prevent accidental discharges caused by a blow to the hammer*, the WRANGLER® revolver is equipped with a transfer bar. When the hammer and trigger are fully forward at the same time, the transfer bar is lowered out of firing position and the hammer rests directly on the frame, not on the firing pin.

* See “Important Safety Note,” p. 12.



 <h2 style="margin: 0;">WARNING – HANDLING</h2>	
	<p>Any time the revolver is loaded, the hammer is cocked, and the trigger is pulled, it will fire. Cocking the firearm or pulling the trigger should only be done when you are ready to fire immediately.</p> <p>NEVER DROP OR STRIKE ANY REVOLVER – COCKED OR UNCOCKED. CARRY AND HANDLE THE REVOLVER IN SUCH A MANNER THAT THE HAMMER WILL NOT BE STRUCK.</p>
<h3 style="margin: 0;">NEVER CARRY ANY REVOLVER WITH THE HAMMER COCKED.</h3>	

TO LOAD AND FIRE

ALWAYS KEEP THE REVOLVER POINTED IN A SAFE DIRECTION!

1. Do not load the revolver until you are ready to use it.
2. Note – The loading gate cannot be opened unless the hammer and trigger are fully forward, and the hammer cannot be cocked once the gate is opened.
3. Open the loading gate. This permits the cylinder to rotate.

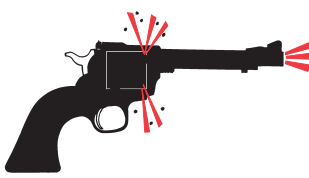
4. Turn the cylinder clockwise, by hand, and insert a cartridge into each of the chambers.
5. Align a chamber with the barrel and close the loading gate. Rotate the cylinder until the cylinder latch drops into a stop notch. The revolver is now in its normal carrying condition – the hammer and trigger are fully forward and the transfer bar is lowered out of the firing position.
6. **NOTE:** The revolver has a cylinder latch that locks the rotation of the cylinder before a shot is fired. This cylinder latch rides on the outside circumference of the cylinder where the stop notches are cut in the cylinder. The cylinder latch design will leave a small wear line around the outside of the cylinder between the notches. This is normal and is an indication that your revolver is functioning properly.
7. Cocking – **DO NOT TOUCH THE TRIGGER WHILE COCKING THE HAMMER. TOUCH THE TRIGGER ONLY WHEN THE HAMMER HAS BEEN FULLY COCKED AND YOU ARE READY TO FIRE.** To fire the revolver, the hammer must first be manually cocked. When cocking the hammer, always ensure that you have a firm grasp on the grip frame with your shooting hand and that you are not touching the trigger. With your thumb firmly on the hammer spur, draw the hammer fully to the rear until it stops. Then, slowly release your thumb from the hammer, permitting it to move slightly forward until the trigger engages the hammer at full cock. **THE REVOLVER IS READY TO FIRE. ENSURE THAT YOU DO NOT CONTACT THE TRIGGER UNTIL YOU ARE READY TO FIRE.**

 <h2 style="margin: 0;">WARNING – FIRING</h2>	
	<p>When firing any revolver, be sure all persons are a safe distance to the rear of the shooter. When fired, all revolvers discharge gas and particles through the clearance gap between the front of the cylinder and rear of the barrel. These particles of lead, powder grains, or lubricant are projected broadly sideways at high speed and thus can injure a person who is standing too close to the revolver. When firing any revolver, always be certain that nothing – including either of your hands – is in the path of the hot gas and particles which are discharged from the front and sides of the cylinder. When shooting, adequate eye protection is essential. Shooters and bystanders must wear shooting glasses. Hearing protection must also be worn. Exposure to shooting noise can damage hearing.</p>
	<h3 style="margin: 0;">HOT GASES EXIT BARREL/CYLINDER GAP</h3>

8. Firing – Once the hammer has been cocked, a light pressure on the trigger will disengage the trigger from the hammer. The hammer will fall forward striking the transfer bar and the revolver will fire.
9. After firing, the hammer will remain down. To fire subsequent shots, fully release the trigger and repeat steps 7 & 8 above for each shot.



CAUTION: The recoil may cause the muzzle of the firearm to flip upward with substantial force. The shooter need not be apprehensive, but be prepared. Keep a firm grip on the revolver and hold it away from your face when firing.

DRY-FIRING: Going through the actions of cocking, aiming, and pulling the trigger of an unloaded firearm is known as “Dry Firing.” It can be useful to learn the “feel” of your revolver. **Be certain the revolver is unloaded and that the firearm is pointing in a safe direction even when practicing by dry-firing.** The WRANGLER® revolver can be dry-fired without damage to the firing pin or other components.



WARNING – SAFE CARRYING POSITION



Never carry revolvers cocked!

The safe carrying position for the Wrangler™ revolver is with the hammer fully down and the trigger forward. In this position the hammer does not contact the firing pin.

NOTE: In older (1953-1972) single-action revolvers, the hammer, when in the full forward position, does rest against the firing pin. (See page 12.)

Accordingly, never carry an “old model” revolver with the hammer fully forward and the cartridge in line with the firing pin because a light blow to the hammer can readily cause discharge. It is always safest to carry the hammer down over an empty chamber regardless of the revolver type. See page 26 for details about our free safety conversion offer for “old model” Ruger® single-action revolvers.



**ALWAYS CARRY YOUR
WRANGLER® REVOLVER
WITH THE HAMMER DOWN.**

TO 'UNCOCK' (DECOCK) THE REVOLVER

If your revolver is cocked, and you wish to let the hammer down to its forward position (against the frame) without firing a round, proceed as follows: **USE EXTREME CARE WHEN ATTEMPTING TO DECOCK THE REVOLVER, AS A "THUMB SLIP" DURING THIS PROCESS CAN RESULT IN AN ACCIDENTAL DISCHARGE IF THE TRIGGER IS HELD TO THE REAR.**

1. Make certain that the revolver is pointing in a safe direction (See Rule 2, p. 30).
2. Make certain both hands are dry and not impeded in any way (i.e., by gloves, bandages, cold, etc.)
3. Grasp the revolver (if right handed) so that the thumb and forefinger of your left hand are firmly holding the frame below the middle of the cylinder (see Figures 6a & 6b below). Your left hand (if right-handed) should support the full weight of the revolver, allowing you to use your right hand to manipulate the hammer and trigger as outlined below.
4. Place your right thumb firmly on the hammer spur and, with your thumb securely in control of the hammer, squeeze the trigger only enough to permit the hammer to 'break free' of the trigger. At that instant, **IMMEDIATELY RELEASE THE TRIGGER** and then slowly permit the hammer, **STILL SECURE UNDER YOUR THUMB**, to move fully forward to its resting position against the frame.

NOTE: It is imperative that finger pressure be removed from the trigger just as soon as it is free of the hammer. Then, properly, the trigger and hammer will move towards their fully forward rest positions together (see Figure 6b, below).

Practice this important firearm handling skill with an unloaded revolver until you have developed the proper control and 'touch' to decock your revolver safely. The key to safe decocking is having the weight of the revolver controlled with one hand, while the thumb and forefinger of the 'shooting hand' control the hammer and trigger.

DECOCKING (UNCOCKING) THE REVOLVER

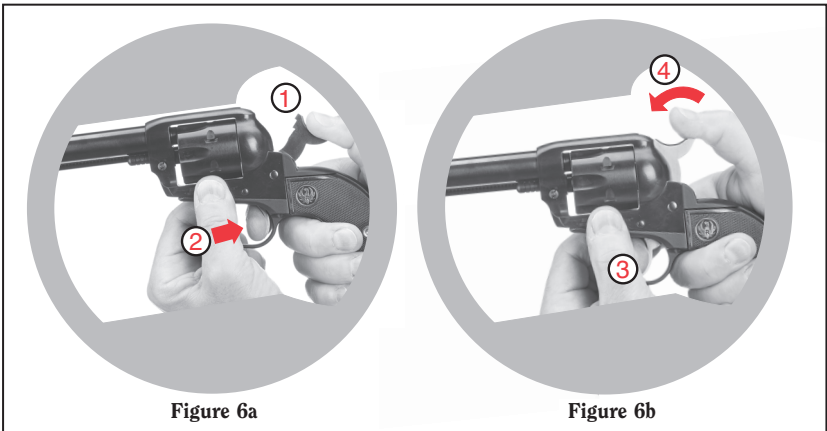

The revolver is now in its normal carrying condition -- hammer and trigger fully forward and transfer bar lowered out of the firing position.



CAUTION: The hammer must be carefully eased fully forward before the hammer is drawn back to the full-cock position for the first shot. The hammer should be drawn with a firm, positive motion to the full-cock position for each shot, thus actuating the working parts for complete indexing. Unless this procedure is followed in any single-action revolver, the cylinder is apt to be out of index when fired.

TO UNLOAD OR EJECT CARTRIDGE CASES

Keep the revolver pointed in a safe direction!
Do not attempt to unload when the hammer is cocked.

If the hammer is cocked, it must first be decocked. (See "To Uncock The Revolver," p. 17.)

Then:

1. Open the loading gate. This permits the cylinder to rotate.
2. Turn the cylinder clockwise, by hand, to align a chamber with the ejector rod assembly.
3. Push the ejector rod assembly rearward, by means of the thumb-piece on its forward end, so that it slides through the chamber to push out the cartridge or fired case. Release the spring-loaded ejector rod. Repeat until all chambers are empty.
4. Check to be certain that all cartridges or casings have been removed, then close the loading gate.

CORRECT UNLOADING SEQUENCE



Do not eject unfired cartridges onto any surface where the cartridge rim might strike a solid object and discharge the cartridge.



WARNING – DISASSEMBLY



Never clean, lubricate, disassemble, or work on a revolver while it is loaded. Never install or remove a loaded cylinder. A loaded cylinder can discharge if dropped or struck. Read and understand all instructions before disassembling the firearm.

UNLOAD BEFORE CLEANING

DISASSEMBLY

(MAKE SURE THE REVOLVER IS UNLOADED!)

The user of a **WRANGLER**[®] revolver should carefully read all disassembly directions and study all the illustrations and the Parts List in this manual before attempting to take the firearm apart. Know the names and location of the parts before removing any of them. Although the **WRANGLER**[®] revolver mechanism is composed of only a few parts, it is essential that the disassembly and reassembly operations be carried out with knowledge and care.

An on-line video demonstrating the disassembly and reassembly of **RUGER**[®] **SINGLE-ACTION** revolvers can be viewed by going to: **Ruger.com/TechTips**.

1. With the revolver pointed in a safe direction, open the loading gate (this lowers the cylinder latch into the frame) and rotate the cylinder. Examine every chamber in the cylinder a few times to be certain the revolver is unloaded. Leave the loading gate open.
2. Press in fully on the left side of the base pin latch, and, while holding it in that position, withdraw the base pin by pulling it forward, in line with the barrel, until it is removed.
3. Remove the cylinder from the loading gate side of the frame. This is as far as you need to go for routine cleaning.



WARNING: Never remove, replace, or carry a loaded cylinder that is not installed in a revolver. The cartridges can fire if their primers are struck.

The revolver is disassembled as far as it needs to be for major cleaning and maintenance. However, if it is necessary to go beyond the above steps, the following cautions and suggestions should be useful:

Ejector Assembly/Ejector Housing: Wrap one hand firmly around the barrel and housing when loosening the ejector housing screw. Remove the ejector housing screw by turning it counter-clockwise, then carefully lift the housing (which contains a compressed spring and ejector rod) away from the barrel. **NOTE:** The ejector housing screw is installed with a thread-locking adhesive. If the screw is removed it is recommended that a non-permanent thread-locking adhesive be reapplied to the screw.

Base Pin Latch/Nut and Spring: The nut must be held firmly (with jaw-protected pliers) while the latch is being unscrewed. Do not lose the spring. When reassembling, be certain the nut and spring are on the left side of the frame. (See Exploded View, p. 29.)

REASSEMBLY

(AGAIN, MAKE SURE THE REVOLVER IS UNLOADED!)

1. Open the loading gate, withdraw the base pin, and install the cylinder. Reinsert the base pin and be certain it is fully seated and locked in position. Rotate the cylinder until the cylinder latch drops into a stop notch.
2. Before loading cartridges into the chamber, cycle the revolver several times. Check to be sure that the cylinder rotates and locks correctly, that the trigger returns in a positive manner when released, and that the loading gate opens and closes normally.

CHECK YOUR REVOLVER'S FUNCTION

(AGAIN, MAKE SURE THE REVOLVER IS UNLOADED!)

Periodic inspection of any firearm is important to ensuring its safe operation. It is important to clean and inspect your firearm after each range session or whenever the firearm has been exposed to sand, dust, moisture, humidity, or other adverse conditions. Proper maintenance increases the longevity of your firearm and will allow early detection of worn or broken parts.

Prior to each use, visually inspect the firearm to ensure no components are damaged, missing, loose, bent, cracked, chipped, or peened. If you observe excessive wear, you should stop using your revolver and contact customer service or a trained certified gunsmith to evaluate its condition and replace any worn parts if necessary.

After reassembly and as part of the regular periodic inspection of your revolver, please perform the following function checks to ensure the revolver is functioning properly.

FIRST, BE SURE THAT EVERY CHAMBER OF THE CYLINDER IS UNLOADED AND ALWAYS KEEP THE REVOLVER POINTED IN A SAFE DIRECTION!

- a. With the revolver pointing in a safe direction, open the loading gate and rotate the cylinder. The cylinder should spin freely without binding.
- b. With the loading gate open, attempt to rotate ("cock") the hammer. You should not be able to cock the hammer.
- c. Close the loading gate and cock the hammer. The hammer should rotate fully to the rear and the cylinder should rotate one-sixth of a revolution without you feeling any unusual drag or require more force than normal.
- d. With the hammer cocked, attempt to open the loading gate. It should not open.
- e. Making sure the firearm is completely unloaded and pointed in a safe direction, dry fire the firearm. The hammer should fall completely.

If you feel some drag, if it is impossible to cock the hammer when you should be able to do so, or the newly-assembled firearm fails any of these checks, first ensure that the base pin is fully seated into the frame. It may be necessary to remove the base pin, reposition the cylinder slightly, and then reinsert the base pin in order to fully seat the base pin.

If any of the above function checks fail or if you are uncertain, please consult a competent gunsmith or contact Ruger Customer Service at 336-949-5200 for further firearm inspection before using the firearm.

CARE AND CLEANING

MAKE SURE THE REVOLVER IS UNLOADED!



Always be certain the revolver is completely unloaded before cleaning. (See “To Unload or Eject Cartridge Cases,” p. 18.) At regular intervals or when the revolver has been exposed to sand, water, or other adverse conditions, disassemble, clean, and oil it.

To clean the revolver after firing:

1. Remove the cylinder as described in the “Disassembly” section on p. 19.
2. From the muzzle, clean the barrel by running a cleaning rod with a solvent coated patch through the bore several times. A bronze wire brush, of a size appropriate to the bore, attached to the cleaning rod should then be pushed the full length of the bore several times.
3. Again, swab the bore with a solvent coated patch. Then, wipe the rod clean and, using a dry patch, swab the bore until it is clean.
4. Repeat the above procedure for each of the six chambers.
5. Run a lightly oiled patch through the bore and each chamber.

Some cartridges with lead bullets deposit metal fouling in the chamber throats, in the forcing cone of the barrel, and in the bore. If ‘leading’ is noted in your revolver, clean it out before it builds up and interferes with reliable functioning and accuracy. A special ‘lead removing’ cleaning tool (for bore and chambers) is available from firearm stores.

The revolver’s internal mechanism can be lubricated without disassembly. A few drops of light oil recommended as suitable for firearms, applied periodically about the various frame openings, will work its way into the mechanism parts. The exterior of the revolver should be cleaned with a solvent and then wiped with an oily cloth. Apply a heavy gun oil or synthetic gun grease to the loading gate pivot and cam surfaces.

 WARNING – LUBRICATION	
	<p>Firing a revolver with oil, grease, or any other material even partially obstructing the bore or chambers may result in damage to the revolver and serious injury to the shooter and those nearby.</p> <p>Do not spray or apply lubricants directly on ammunition. If the powder charge of a cartridge is affected by the lubricant, it may not be ignited, but the energy from the primer may be sufficient to push the bullet into the bore where it may become lodged. Firing a subsequent bullet onto the obstructed bore may damage the revolver and cause serious injury or death to the shooter and those nearby. Use lubricants properly. You are responsible for the proper care and maintenance of your firearms.</p>
	IMPROPER LUBRICATION DESTROYS FIREARMS



STORAGE

FIREARMS SHOULD NOT BE STORED LOADED!

USE THE LOCKING DEVICE SUPPLIED WITH THE REVOLVER TO RENDER IT INOPERATIVE FOR SAFE STORAGE.

(SEE PAGE 10)

Do not keep your revolver in a leather, fabric, or canvas holster when it is stored. These materials attract moisture, even though the holster may appear to be perfectly dry.

 WARNING – STORAGE	
	<ul style="list-style-type: none">• Never place or store any firearm in such a manner that it may be dislodged. Firearms should always be stored securely and unloaded, away from children and careless adults.• Use the locking device supplied with the revolver for storage. The use of a locking device or safety lock is only one aspect of responsible firearms storage.• For increased safety, firearms should be stored unloaded in a location that is both separate from their ammunition and inaccessible to children and any other unauthorized person.
STORE SECURELY & UNLOADED	

FIXED SIGHTS

The WRANGLER® revolver features a blade front sight and a fixed rear sight. They are factory set to be on target at 15 yards and cannot be further adjusted.

SERVICE AND PARTS POLICY

If you have any questions with regard to the performance of your RUGER® WRANGLER® revolver please contact our Customer Service online at **Ruger.com** or call the Customer Service Dept. at 336-949-5200. Fully describe all circumstances and conditions involved. If you should need to return your revolver to the factory for repair, or order parts for it, please comply with the following suggestions for prompt service:



WARNING: BEFORE SHIPPING ANY FIREARM, BE ABSOLUTELY CERTAIN THAT IT IS UNLOADED. DO NOT SHIP CARTRIDGES WITH A FIREARM.

SHIPPING FIREARMS FOR REPAIR



NOTE: You must obtain a **Repair Authorization Number** before returning your firearm. An authorization number can be obtained by contacting Customer Service online at **Ruger.com** or calling the Customer Service Dept. at 336-949-5200. Firearms should be sent prepaid. We will not accept collect shipments. RUGER® WRANGLER® revolvers returned to the factory for repair should be sent to: Sturm, Ruger & Company, Inc., Customer Service Department, 411 Sunapee St., Newport, NH 03773.

The Federal Gun Control Act, as well as the laws of most states and localities, do not prohibit an individual (who is not otherwise barred from purchasing or possessing a firearm) from shipping a firearm directly to the manufacturer for repair. However, before you ship your firearm to us, be certain that your state or locality does not have a law or regulation which will prohibit you from receiving the firearm from us after repair. If such receipt is prohibited, please have a federally licensed firearms dealer ship the firearm to us. If your firearm is sent to us by a dealer, it will be returned to that dealer after being repaired. If a handgun (pistol or revolver) is shipped by an individual who does not hold a Federal Firearms License, it must be shipped for overnight delivery via U.P.S., Federal Express, or other, similar private overnight service. **NOTE:** Handguns may not be shipped via U.S. Mail. Persons who do not hold a Federal Firearms License are prohibited by Federal law from shipping a handgun by Mail. Handguns mailed in violation of the law may be impounded or confiscated by the Post Office and the non-FFL may be subject to prosecution.

Please do not include any cases, telescopic sights, or custom accessories with a firearm being shipped to the factory for service. **DO NOT SEND FIREARM BOXES OR LITERATURE THAT YOU CONSIDER TO BE COLLECTOR'S ITEMS – THESE ARE INVARIABLY DAMAGED OR DESTROYED IN SHIPMENT.** Always insure your shipment.

Enclose a letter which includes your name, address, telephone number, firearm serial number and model, and repair authorization number. Describe in detail the trouble you have experienced with your firearm, or the work you wish to have done. Merely stating that the firearm “needs repair” is inadequate information. Please include copies of any previous correspondence.

All work performed is subject to a minimum labor charge and charges for shipping and handling. Custom gunsmithing service or nonstandard alterations are NOT AVAILABLE from Ruger Customer Service Departments. Please contact the Customer Service Department for pricing information.

 WARNING – PARTS PURCHASERS	
	<ul style="list-style-type: none">• It is the purchaser's responsibility to be absolutely certain that any parts ordered from the factory are correctly fitted and installed.• Firearms are complicated mechanisms and IMPROPER FITTING OF PARTS MAY RESULT IN A DANGEROUS MALFUNCTION, DAMAGE TO THE FIREARM, AND SERIOUS INJURY TO THE SHOOTER AND OTHER PERSONS.• The purchaser and installer of parts must accept full responsibility for the correct adjustment and functioning of the firearm after such installation.
PARTS MUST FIT CORRECTLY	

ORDERING PARTS

Please contact the Newport, New Hampshire Customer Service Department for parts availability and current prices. All parts orders for RUGER® WRANGLER® revolvers should be sent to: Sturm, Ruger & Co., Inc., Customer Service Department, 411 Sunapee Street, Newport, NH, 03773, 336-949-5200.

We cannot comply with open account or C.O.D. orders. Payment in full via credit card (Visa or MasterCard only), money order or certified bank check (no personal checks or cash, please) is required before any service will be performed. Please provide your credit card number, your name as it appears on the credit card, the expiration date, and the 3-digit security code. All parts orders are subject to a minimum charge and charges for shipping and handling. Order parts by **Part Name and specify the model and entire serial number** of the firearm for which the parts are being ordered. There is a minimum labor charge plus a shipping and handling charge if the parts are factory fit. All factory fit parts are fit on an exchange basis only. We will not return the replaced parts. Please contact the Customer Service Department for pricing information.

Because it is a serial numbered part, the cylinder frame of the RUGER® WRANGLER® revolver is defined as a 'firearm' by Federal Law and is not offered for sale as a separate component.

Parts designated by an (*) must be factory fit. These parts are fit on an exchange basis only. We will not return the replaced parts. We will not return any part that is broken, malfunctioning, badly worn, or has been modified. See "Warning – Parts Purchasers," above.

IMPORTANT – WHEN ORDERING PARTS, INCLUDE THE COMPLETE SERIAL NUMBER AND SPECIFY THE CALIBER AND BARREL LENGTH.

NOTE: All revolvers are marked with a safety message informing the user that they should read this instruction manual before using the firearm.

Some component parts must be fit at the factory. Company policy is to proof-test and/or function fire all barrels after fitting to the receiver frame, or cylinder frame in which they are to be used. This procedure ensures maximum protection to our customers. The special proof-test ammunition used in this testing is sold only to bonafide firearms manufacturers and is not available to gun shops, gunsmiths, or individuals.



WARNING: A firearm containing broken, malfunctioning, or badly worn parts should not be fired!

SHIPPING REVOLVERS FOR INSTALLATION OF A SAFETY CONVERSION KIT:

If you would like to have any “old model” (pre-1973) Bearcat®, Single-Six®, Blackhawk®, or Super Blackhawk® revolver factory fitted with a free Conversion Kit (to help prevent accidents caused by a blow to the hammer if the user has failed to keep an empty chamber under the hammer) please write to Ruger, Conversion Dept., 411 Sunapee Street, Newport, NH 03773 for a box and shipping instructions. Be sure to include information as to model, caliber, and serial number. **Please do not send your old model single-action revolver until you receive shipping instructions and a box from us.** Please note that the kit will be fitted at our Newport, New Hampshire facility. All other servicing of “old model” single-actions will also be performed at our Newport facility, but only after a Conversion Kit is first installed.

This safety conversion does not apply if the revolver is marked “Vaquero,” “New Vaquero,” “Bisley™,” “New Bearcat,” “New Model,” or “Wrangler” on the frame.

RUGER® WRANGLER® REVOLVER

PARTS LIST

Design, prices, and specifications subject to change without notice.

SPECIFY MODEL, CALIBER, AND SERIAL NO. WHEN ORDERING

(See Exploded Views on Page 29)

Key	Part Name
* 1	Barrel
2	Grip Frame
† 3	Cylinder Frame
4	Front Sight
5	Loading Gate
6	Firing Pin Plug
* 7	Firing Pin
8	Firing Pin Spring
9	Base Pin Assembly
10	Trigger Spring Retaining Pin
11	Trigger Spring Pivot Pin
12	Trigger Spring
13	Cylinder
14	Hammer Assembly – (Key Nos. 15 - 17)
15	Hammer Plunger Cross Pin
16	Hammer Plunger
17	Hammer Plunger Spring
18	Pawl Spring Plunger
19	Pawl Spring
20	Cylinder Latch Spring Plunger
21	Cylinder Latch Spring
22	Trigger Pivot Pin

* PARTS SO MARKED MUST BE FACTORY FIT.

† Because it is a serial numbered part, the cylinder frame is defined as a 'firearm' by Federal Law and is not offered for sale as a component part.

Key	Part Name
23	Grip Frame Screw – A – Front
24	Hammer Pivot Pin
25	Hammer Strut
26	Mainspring
27	Mainspring Seat
28	Trigger
29	Grip Frame Screw & Pivot Lock
30	Grip Frame Screw – C – Bottom
31	Grip Frame Screw – B – Back (2 Req'd)
32	Gate Detent Spring
33	Cylinder Latch
34	Transfer Bar
35	Pawl
36	Ejector Rod Assembly
37	Ejector Housing
38	Ejector Housing Screw
39	Ejector Housing Spring
40	Grip Panel Nut
41	Grip Panels, Sold in Pairs Only
42	Grip Panel Screw
43	Pawl Guide
44	Base Pin Latch Body
45	Base Pin Latch Spring
46	Base Pin Latch Nut

RUGER® WRANGLER® REVOLVER EXPLODED VIEW

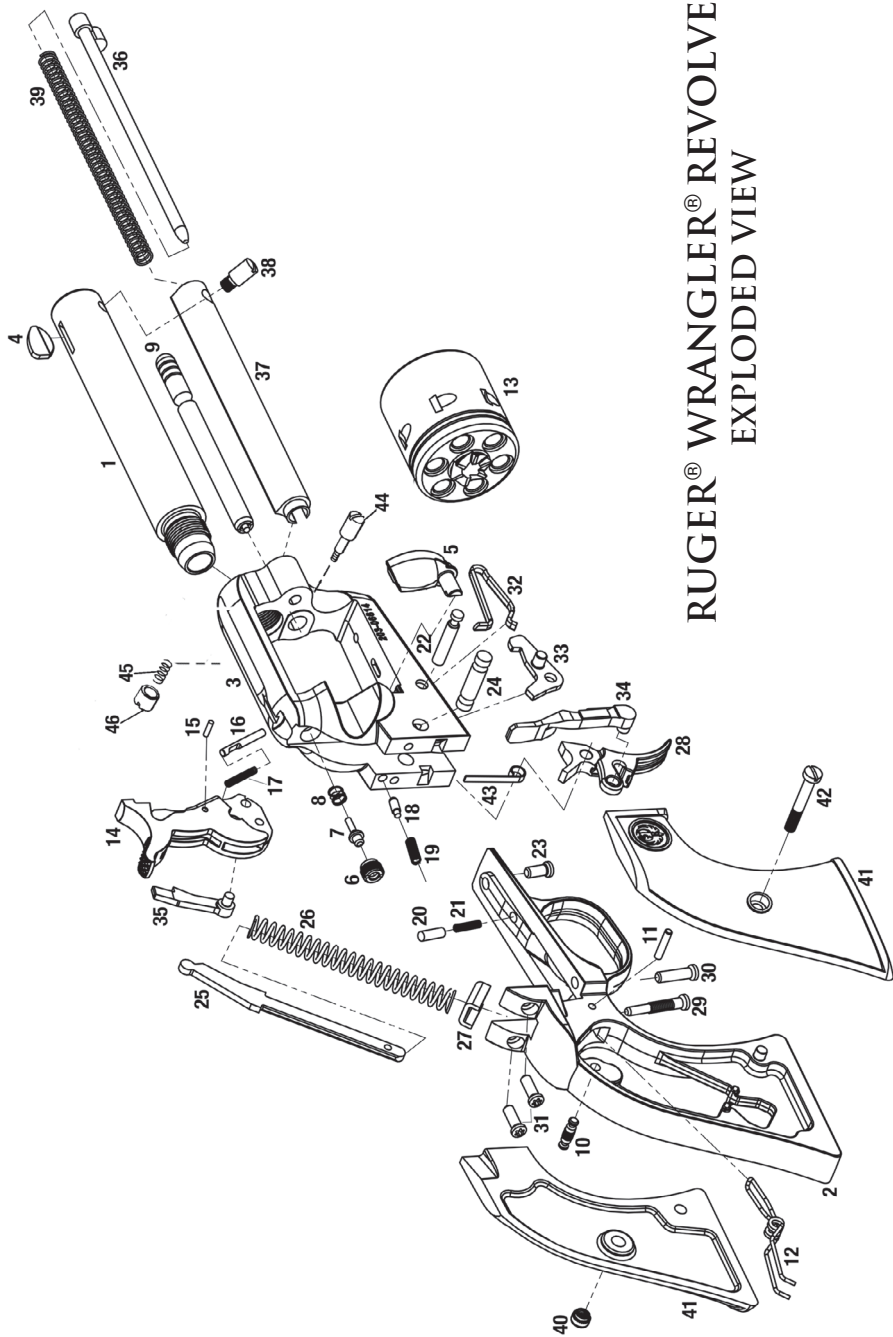

THE BASIC RULES OF SAFE FIREARMS HANDLING

We believe that Americans have a right to purchase and use firearms for lawful purposes. The private ownership of firearms in America is traditional, but that ownership imposes the responsibility on the gun owner to use his firearms in a way which will ensure his own safety and that of others. When firearms are used in a safe and responsible manner, they are a great source of pleasure and satisfaction, and represent a fundamental part of our personal liberty.

Firearms do not cause accidents! Firearms accidents are almost always found to have been the result of carelessness or ignorance on the part of the shooter of the basic rules of safe gun handling.

The following rules must be observed by gun users at all times. Safe gun handling is not just desirable, it is absolutely essential to your safety, the safety of others, and the continuation of gun ownership and sport shooting as we know it today.

1. LEARN THE MECHANICAL AND HANDLING CHARACTERISTICS OF THE FIREARM YOU ARE USING.



Not all firearms are the same. The method of carrying and handling firearms varies in accordance with the mechanical provisions for avoiding accidental discharge and the various proper procedures for loading and unloading. No person should handle any firearm without first having thoroughly familiarized himself with the particular type of firearm he is using, and with safe gun handling in general.

2. ALWAYS KEEP THE MUZZLE POINTED IN A SAFE DIRECTION.



Be sure of the bullet stop behind your target, even when dry-firing. Never let the muzzle of a firearm point at any part of your body or at another person. This is particularly important when loading or unloading a firearm. In the event of an accidental discharge, no injury can occur as long as the muzzle is pointing in a safe direction. A safe direction means a direction that will not permit a discharged bullet to strike a person, or to strike an object from which the bullet may ricochet.

A safe direction must take into account the fact that a bullet may penetrate a wall, ceiling, floor, window, etc., and strike a person or damage property. Make it a habit to know exactly where the muzzle of your gun is pointing whenever you handle it, and be sure that you are always in control of the direction in which the muzzle is pointing, even if you fall or stumble. Keep your finger off the trigger until you are ready to shoot!

3. FIREARMS SHOULD BE UNLOADED WHEN NOT IN USE.

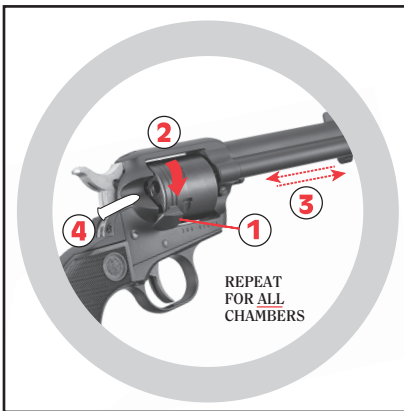

Firearms should be loaded only when you are in the field or on the target range or shooting area, ready to shoot. Firearms and ammunition should be securely locked in safes, racks or cabinets, or by using the locking device supplied with the firearm, when not in use. Ammunition should be safely stored separate from firearms. Store your firearms out of sight of visitors and children. It is the gun owner's responsibility to be certain that children and

persons unfamiliar with firearms cannot gain access to firearms, ammunition, or components.

4. BE SURE THE BARREL IS CLEAR OF OBSTRUCTIONS BEFORE SHOOTING.

Even a bit of mud, snow or excess lubricating oil or grease in the bore may cause the barrel to bulge, or even burst on firing, and can cause serious injury to the shooter and bystanders. Be sure that you are using ammunition of the proper caliber and loading for the gun you are using. If the report or recoil on firing seems weak, or doesn't seem quite right, CEASE FIRING IMMEDIATELY, unload your firearm, and check to be sure that no obstruction has become lodged in the barrel.





5. BE SURE OF YOUR TARGET BEFORE YOU SHOOT.

Don't shoot unless you know exactly where your bullet is going to strike. Be sure of the bullet stop behind your target, even when dry-firing with an unloaded gun. If you are in the field hunting, do not fire at a movement or noise. Take the time to be absolutely certain of your target before you pull the trigger.

6. WEAR SHOOTING GLASSES AND HEARING PROTECTION WHEN YOU SHOOT.

All shooters should wear protective shooting glasses and adequate hearing protection when shooting. Exposure to shooting noise can damage hearing, and wearing adequate eye protection when shooting is essential.



7. NEVER CLIMB A TREE OR FENCE WITH A LOADED FIREARM.

Put the firearm down carefully before climbing a fence, and unload it before climbing or descending a tree or jumping over a ditch or other obstruction. Never pull or push a loaded firearm toward yourself or another person. When in doubt, or whenever you are about to do anything awkward, unload your gun!

8. DON'T SHOOT AT A HARD SURFACE OR AT WATER.

Bullets can glance off many surfaces like rocks or the surface of water and travel in unpredictable directions with considerable velocity.



9. NEVER TRANSPORT A LOADED FIREARM.

Firearms should always be unloaded before being placed in a vehicle. A suitable carrying case or scabbard should be used to carry an unloaded firearm to and from the shooting area.

10. AVOID ALCOHOLIC BEVERAGES WHEN SHOOTING.

Don't drink until the day's shooting is over. Handling firearms while under the influence of alcohol in any form, or medications that could affect your judgment or coordination, constitutes a criminal disregard for the safety of others.



A BRIEF ACCOUNT OF AN EXTRAORDINARY ACHIEVEMENT: RUGER® FIREARMS

Sturm, Ruger & Company, Inc., had its beginning in a small machine shop occupying a rented frame building in Southport, Connecticut. In January, 1949, with an initial investment of only \$50,000 and an idea, William B. Ruger and Alexander M. Sturm started production of a .22 caliber autoloading pistol—a design which was so successful that it became the cornerstone upon which one of the most comprehensive lines of sporting firearms ever made in America was established. After Alex Sturm's death in 1951, William B. Ruger continued to direct the Company until his death in 2002. William B. Ruger, Jr. continued to provide guidance, which helped make this Company a sound and successful enterprise, until his retirement in 2006. The Company has continued to prosper, under new management and guidance from our Board, with new products and fresh perspectives.

Ruger, in this relatively short time, has established itself as a leading small arms design organization, developing a unique and broad line of fine quality sporting, military and police firearms to become one of the world's most famous producers of revolvers, pistols, rifles and shotguns. Since 1949, Ruger craftsmen have built many millions of firearms.

During its five decades of growth and progress under the leadership of William B. Ruger, the Company developed a business philosophy and implemented policies which represent a constructive influence in the life of modern America. From the beginning, Ruger played a positive role in conservation efforts and has supported the interests of shooters through such groups as the National Rifle Association, National Shooting Sports Foundation, and many regional sportsmen's organizations.

The Company has always endeavored to market its firearms for constructive and recreational purposes, to emphasize the traditional and responsible aspects of shooting, to render meaningful public services, and to encourage shooters in constructive, responsible, and safe participation in the shooting sports. Its motto, "Arms Makers For Responsible Citizens®," exemplifies this Company philosophy.

Today, Ruger® is particularly mindful of those elements which have contributed to the creation of its success, and extends heartfelt thanks to its many loyal employees and customers.

The firearms catalog, and instruction manuals for all Ruger® firearms, can be downloaded from our website at:

Ruger.com

NOTES

WHY NO WARRANTY CARD HAS BEEN PACKED WITH THIS NEW RUGER® FIREARM

The Magnuson-Moss Act (Public Law 93-637) does not require any seller or manufacturer of a consumer product to give a written warranty. It does provide that if a written warranty is given, it must be designated as "limited" or as "full" and sets minimum standards for a "full" warranty. Sturm, Ruger & Company, Inc. has elected not to provide any written warranty, either "limited" or "full", rather than to attempt to comply with the provisions of the Magnuson-Moss Act and the regulations issued thereunder. There are certain implied warranties under state law with respect to sales of consumer goods. As the extent and interpretation of these implied warranties varies from state to state, you should refer to your state statutes. Sturm, Ruger & Company wishes to assure its customers of its continued interest in providing service to owners of Ruger® firearms.



STURM, RUGER & COMPANY, INC.
411 SUNAPEE STREET
NEWPORT, NEW HAMPSHIRE 03773 U.S.A.
RUGER.COM
ARMS MAKERS FOR RESPONSIBLE CITIZENS®

**A COPY OF THE INSTRUCTION MANUAL FOR ANY RUGER®
FIREARM IS AVAILABLE FROM THE FACTORY FREE ON REQUEST, OR IT MAY BE
DOWNLOADED FROM OUR WEBSITE AT RUGER.COM.
THESE INSTRUCTION MANUALS CONTAIN IMPORTANT
WARNINGS WHICH MUST BE UNDERSTOOD
BEFORE USING THESE FIREARMS.**

The Following are Sturm, Ruger & Co., Inc. Trademarks: "All-Weather," "Bisley," "Gold Label," "I'm a Ruger American," "LC6," "LCR-357," "LC380CA," "Mark II," "Mark III," "Mark IV," "MAX-9," "Model 96," "P345," "P345D," "P345PR," "P85," "P89," "P90," "P91," "P93," "P94," "P95," "P97," "PC Carbine," "R.I.O.S.," "Ruger-57," "Ruger Marksman Adjustable," "Ruger 77/50," "Ruger 10/17," "Security-Six," "Service-Six," "77/357," "Single-Seven," "Speed-Six," "SR45," "SR-556C," "SR-556VT," "Super Bearcat," "Target Grey," "10/22-FS," "This is Ruger. This is America.," "Tri-Flex," "22 Charger," "22/45," "22/45 RP," and "Your Next Handgun."

The Following are Registered U.S. Trademarks Belonging to Sturm, Ruger & Co., Inc.: "AC-556," "AR-556," "Arms Makers For Responsible Citizens," "Bearcat," "Blackhawk," "BX-15," "BX-25," "BX-Trigger," "Eagle - solid logo design, Eagle Hard 'R' logo holding gun, Eagle 'R' - soft 'R' & hard 'R' logo design, Eagle w/'SR', Eagle w/soft 'R' linear logo design, Eagle w/hard 'R' linear logo design, Eagle w/soft 'R' stacked logo design, Eagle w/hard 'R' stacked logo design, Eagle w/soft 'R' linear logo design & "Rugged, Reliable Firearms" below logo, Eagle w/hard 'R' linear logo design & "Rugged, Reliable Firearms" below logo, "EC9s," "Elite 452," "GP100," "Hawkeye," "It's Mine and It's American," "It's Mine. And It's American," "LC380," "LC9," "LC9s," "LC9s Pro," "LCP," "LCR," "LCRx," "M77," "Match Champion," "Mini-14," "Mini Thirty," "9E," "Old Army," "Power Bedding," "Redhawk," "RUGER," "Ruger American," "Ruger American Pistol," "Ruger American Pistol" flag design, "Ruger American Rifle," "Ruger American Rimfire," "Ruger Custom Shop," "Ruger Hunting" - phrase & logo design, "Ruger Precision," "Ruger Precision Rifle" - phrase & logo design, "Ruger 77/17," "Ruger 77/22," "Ruger 77/44," "Ruger SP101," "Ruger 10/22 Takedown" phrase & logo design, "Ruger Titanium," "Ruger 22/45 Lite," "Ruger Vaquero," "Rugged, Reliable Firearms," "Security-9," "Silent-SR," "Single-Nine," "Single-Six," "Single-Ten," the "SR" Design, "SR9," "SR9c," "SR40," "SR40c," "SR-22," "SR22," "SR-556," "SR-556 Takedown," "SR-762," "SR1911," "Super Redhawk Alaskan," "10/22," & "Wrangler."