

SPRINGFIELD ARMORY®

1911

OPERATION & SAFETY MANUAL

IMPORTANT SAFETY INFORMATION INSIDE

Read this manual before handling this firearm. Keep this manual with your firearm and review it before each use. Do not allow others to handle or fire your firearm until they have read this manual. Transfer this manual with the firearm upon ownership change. *Be a responsible firearm owner. Use it safely, store it securely, and always transfer a firearm responsibly and legally.*

DOWNLOAD THIS MANUAL ON OUR WEBSITE: WWW.SPRINGFIELD-ARMORY.COM

Always check website for updated versions of operation & safety manuals

CONTENTS

Read and Understand this Manual	3
Know Your Gun.....	4
Safety Rules	5
Loaded Chamber Indicator	12
Springfield's Integral Locking System (ILS™)	13
Loading	18
Firing	19
Fiber Optic Front Sight Installation	20
Unloading.....	21
Hammer Lowering	23
Malfunction Warning	24
Disassembly and Assembly	
Section 1: Full-Size Models	26
Section 2: TRP™ Operator® Model	32
Section 3: V-12, V-16, and Long Slide Models.....	36

Section 4: Micro-Compact, Ultra Compact, V-10, Compact, EMP® 3", EMP® 4" and Champion™ Models ..	41
Alternate Method For Disassembly.....	44
Ported Barrel	47
Point of Aim.....	49
Exploded View & Parts List	
Mil-Spec Models	50
"Loaded" Models.....	52
High Capacity Models.....	54
Micro-Compact Models	56
Cable Lock	58
Care and Cleaning.....	59
Warning	62
Limited Warranty.....	63

If you have any questions concerning information in this manual, call Springfield's Consumer Safety Department at (309) 944-5631 for assistance.

BEFORE LOADING AND FIRING THIS FIREARM, READ AND UNDERSTAND THE INFORMATION IN THIS MANUAL.

This is an auto loading firearm. It is immediately loaded and ready to fire again after each shot until all cartridges loaded in magazine have been fired. The firearm is able to fire both with and without the magazine in place.

REMOVING THE MAGAZINE DOES NOT UNLOAD THE FIREARM NOR DOES IT ENGAGE A SAFETY. THE FIREARM IS NOT UNLOADED UNTIL THE MAGAZINE IS REMOVED AND THE CHAMBER IS EMPTY.

ABOUT YOUR OWNER'S MANUAL

This is an instruction booklet on how to operate this firearm with some basic safe handling rules. It does not attempt to provide information about using a firearm to defend yourself, how to hunt, or for competitive or target shooting. It is important to receive training from a competent firearms instructor prior to engaging in any of these activities. The National Rifle Association, your local or state authorities, or your firearm dealer may provide information regarding available instructors or training courses. If you have a license to carry concealed, never do so without prior instruction from a certified instructor. Using a firearm for self defense is a complex subject with dangers and risks for which you must be properly trained. Every safety rule has a reason behind it - read the rules carefully and understand why each is important for safety.

It is recommended that every person receive instructions from a competent firearms instructor before handling this or any other firearm.

Know and obey all firearm laws and regulations, which may vary from city to city and state to state. Do not give a firearm to someone who is not allowed to own a firearm or who may use it for a criminal purpose.

Used firearms

If you purchased this firearm as a used firearm, have it inspected and tested by a competent pistolsmith before you use it. Firearms are sometimes altered and may require repair before they can be used safely.

Store firearms safely in the home

Store firearms unloaded, locked and in a secure place. Obey firearm storage laws. Store firearms and ammunition separately. Because your children may be in other homes where firearms are stored, you should show them what to do if they see or find a firearm by showing them the Eddie Eagle video available from the NRA by calling (703) 267-1000.

OBEY ALL GUN LAWS WHEN BUYING AND SELLING FIREARMS. NEVER BUY A GUN INTENDING TO TRANSFER IT TO SOMEONE WHO IS PROHIBITED FROM OWNING FIREARMS. NEVER EVER BE A "STRAW PURCHASER."

KNOW YOUR FIREARM

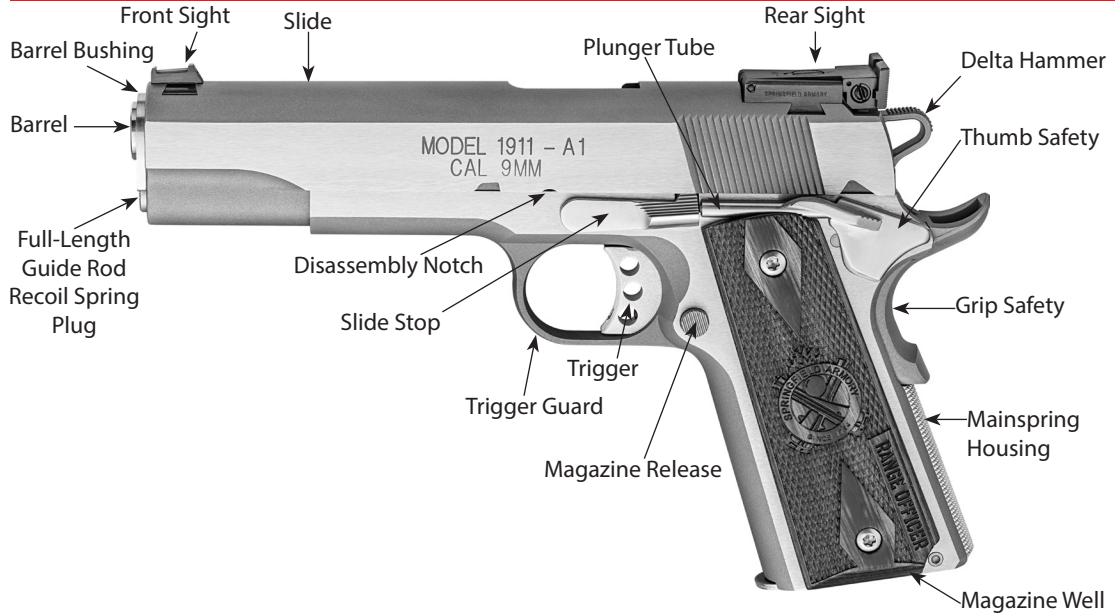

SAFETY RULES

READ AND UNDERSTAND THESE SAFETY RULES

Be A Safe Firearm Owner.

ACCIDENT (*ak' si dent*) *N. 1. An unintentional or unexpected happening that is undesirable or unfortunate, especially one resulting in injury, damage, harm or loss.*

Don't be the cause of an accident.

A responsible firearm owner is safety minded and always handles firearms in a safe manner by following the basic rules of safe shooting and by using common sense in the handling of a firearm.

Store firearms unloaded, locked, and in a secure place. Keep keys for locks separate from lock and in a secure place away from children. Keep firearms out of reach of children. You are responsible for children's safety.

Be A Responsible Firearm Owner.

- **Treat all firearms as if they are loaded at all times.**
- Although many safety mechanisms are designed into your firearm, firearm safety still depends on you being a responsible firearms owner.

- Never point a firearm at any person or thing you do not intend to shoot.
- Be sure you have positively identified your target.
- **ALWAYS KEEP THE MUZZLE POINTED IN A SAFE DIRECTION.**
- **Do not drop your firearm.** Make sure you maintain control of your firearm at all times. **If it falls, it may fire.** If you do drop it, unload it and examine it to be sure it works correctly. Do not attempt to fire it again until you have completed this safety check.
- Never put your hand over the muzzle of the firearm.
- Keep your finger(s) off the trigger and out of the trigger guard until you are actually aiming at your target, and made the decision to fire.
- Under no circumstances should the owner of this firearm allow it to come into possession of or be handled by small children or a mentally handicapped individual.
- **DO NOT COVER THE EJECTION PORT WITH YOUR HANDS WHEN LOADING/UNLOADING YOUR FIREARM.**

BE A RESPONSIBLE FIREARM OWNER!

- Never rely on a firearm's "safety features" to protect you from unsafe firearm handling. A safety is only a mechanical device, not a substitute for common sense.
- Keep your finger off the trigger until you are on target and have made the DECISION to fire.
- Be sure of your target and backstop before you shoot. Ask yourself what your bullet will hit if it misses or goes through the target.
- Before shooting, be sure the barrel is clear of obstructions, including excessive oil and grease.
- Do not let water, snow, mud or other materials enter the barrel.
- Do not pull a firearm toward you by the muzzle.
- Always hold your firearm so you control the direction of its muzzle in case you fall or stumble.
- **ALWAYS KEEP THE MUZZLE POINTED IN A SAFE DIRECTION.**
- If anything does get into the barrel, remove cartridges, and clean bore immediately before attempting to shoot. Obstructed barrels can burst and injure you and/or bystanders.
- Maintain possession of your firearm at all times when you are on the firing range or during target practice. **DO NOT ALLOW OTHERS TO HANDLE YOUR FIREARM UNLESS THAT PERSON IS BEING INSTRUCTED OR TRAINED.**
- **DO NOT COVER THE EJECTION PORT WITH YOUR HANDS WHEN LOADING/UNLOADING YOUR FIREARM.**



The 1911-A1 pistol, like all firearms, is a dangerous weapon if not handled properly.

BE A SAFE SHOOTER!

- **ALWAYS KEEP THE MUZZLE POINTED IN A SAFE DIRECTION.**
- Firearms and alcohol or drugs do not mix. Do not take them before or during shooting activities. Your vision, coordination and judgment could be impaired, making firearm handling unsafe.
- When taking medication, seek a doctor's advice to be sure you can operate and handle your firearm safely.
- Receive training from a competent firearms instructor before using any firearm.
- Before attempting to shoot, practice operations by using snap caps (dummy rounds). Become familiar with the safety features, trigger control, and handling of the firearm.
- Make sure you maintain control of your firearm at all times.
- **Always keep and carry your firearm with an empty chamber until you intend to shoot, so your firearm cannot be fired unintentionally.**
- Firearms should be unloaded when not in use. This means both the chamber and magazine are empty.
- When transferring a firearm by hand, always open the action and check to assure that it is unloaded prior to handing it over to someone.
- Never take anyone's word that a firearm is unloaded. When receiving a firearm, always open the action and check that it is unloaded.

READ THESE RULES!

- Load firearm only when on range preparing to fire. Unload it before leaving range.
- **Treat every firearm as if it is loaded ... all the time!**
- Load and unload with the firearm muzzle pointed in a safe direction.
- Be certain firearm is unloaded before cleaning.
- Completely unload your firearm before storing, travelling, standing it against an object, laying it down, entering a house, car, truck, boat, RV/camper, building, or handing it to someone.
- **Never leave a loaded firearm unattended.**
- Tragedy may result if a child finds your firearm and plays with it. Keep every firearm secure. Children do not believe firearms can kill.
- Store firearms and ammunition separately. Both should be placed beyond children's reach.
- Obey all laws regarding the storage and security of firearms in the home.
- Know and obey the laws regarding the transportation and carrying of firearms.
- **Never carry any firearm, loaded or unloaded, in your pocket, purse or tucked in your belt or waistband. Use a firearm case or a proper holster.**
- **Old or reloaded ammunition may cause damage to the firearm and/or injure you or others. Use only clean, dry, original, high-quality, commercially manufactured ammunition. Using reloaded ammunition will void the warranty.**
- **ALWAYS REMEMBER, REMOVING THE MAGAZINE DOES NOT UNLOAD THE PISTOL NOR DOES IT ENGAGE A SAFETY.**
- **ALWAYS REMEMBER, THE PISTOL IS NOT UNLOADED UNTIL THE MAGAZINE IS REMOVED AND THE CHAMBER IS EMPTY.**
- **ALWAYS REMEMBER, THIS FIREARM IS ABLE TO FIRE WITH OR WITHOUT THE MAGAZINE IN PLACE.**
- **DO NOT COVER THE EJECTION PORT WITH YOUR HANDS WHEN LOADING/UNLOADING YOUR FIREARM.**

TREAT EVERY FIREARM AS IF IT IS LOADED... ALL THE TIME!

- Many ammunition identifications sound similar. Make sure you use the right caliber/size ammunition in your firearm.
- If firearm fails to fire when the trigger is pulled, keep it pointed at the target for at least 30 seconds. Remove the magazine before opening the action. Remove the cartridge from the chamber. Sometimes slow primer ignition will cause a “hang fire” and the cartridge will go off after a short pause.
- When group firing, always appoint someone to maintain safety control. Obey his/her commands immediately and completely.
- While person is loading, firing, and unloading, spectators need to remain behind the users.
- **Always wear protective glasses when shooting.**
- **Always wear hearing protection when shooting.**
- Never shoot at hard flat surfaces or water; bullets will ricochet unpredictably.
- Do not alter or modify your firearm.
- Have your firearm serviced regularly by a qualified pistolsmith.
- Discharging firearms in poorly ventilated areas, cleaning firearms, or handling ammunition may result in exposure to lead and other substances known to cause birth defects, reproductive harm, cancer and other serious physical injury. Have adequate ventilation at all times. Wash hands thoroughly after firing your firearm, after cleaning your firearm, or whenever you have handled ammunition.
- Always use quality ammunition.
- **ALWAYS KEEP THE MUZZLE POINTED IN A SAFE DIRECTION.**
- **DO NOT COVER THE EJECTION PORT WITH YOUR HANDS WHEN LOADING/UNLOADING YOUR FIREARM.**



Always wear eye and ear protection when using any firearm. Safety and instruction manuals are available from Springfield, Inc.

BE A SAFE SHOOTER!

- Do not try to change your firearm's trigger pull, because alterations of trigger pull usually affect sear engagement and might cause accidental firing.
- Never use a firearm that jams or fails to function properly. Should this occur, return to Springfield, Inc. for warranty/repair.
- If your shot sounds weak or underpowered, it could mean a bullet is in the chamber/bore. The firearm should be immediately unloaded and the chamber/bore checked for obstructions before re-firing.
- **DO NOT "HORSEPLAY"** with a firearm. Your firearm cannot think ...but you can. Firearm safety depends on you.

Write or call us concerning any items you do not understand and/or which might relate to your safety and the safe operations of any of our products.

Springfield, Inc.

Consumer Safety Department

420 West Main Street

Geneseo, IL 61254

1-800-680-6866

IMPORTANT WARNING

There is no safe way to discharge a firearm in a home or apartment. Bullets will go through walls, floors, furniture, and appliances and still cause serious injury or death to persons in the house, next door, or outside. Accidental discharges indoors ALWAYS result in property damage or personal injury.



WARNING: When you squeeze the trigger, you must expect the firearm to fire. You must take full responsibility for firing it. Your care can avoid accidental discharge and thereby avoid accidental injury and death.

HANDLING

We want you to be a safe, satisfied shooter.

Before attempting to load this firearm with live ammunition, follow the sequence of operations shown here without ammunition or with dummy shells.

By practicing operations with snap caps (or with dummy rounds), you will become familiar with:

- Safety features,
- Trigger control (snap caps),
- Handling of your firearm.

As a result you will be a safer, more confident shooter when aiming at your first target.

Safety Stop on Hammer

The Safety Stop is a flat, shelf-like surface on the hammer which functions automatically. It will engage the sear in the unlikely event of primary sear notch failure. This will prevent the hammer from falling fully forward unintentionally and will insure against uncontrolled automatic fire. It also prevents the hammer from striking the firing pin should your hand slip from the slide or hammer while cocking the pistol, provided the hammer is rotated past the Safety Stop. It is located such that when the sear

engages the Safety Stop, the sear can be disengaged by squeezing the trigger. It falls because the sear slides over the flat part of the safety stop to release the hammer. This is intentional but will not allow the pistol to fire. It will not fire because the hammer is almost fully forward when it is released from the sear. The Safety Stop is not a manual safety and should not be engaged by hand. Do not carry the firearm while Safety Stop is engaged.

Caution: Control hammer with your thumb and forefinger (Figure 1). Always point pistol in a safe direction when squeezing the trigger to lower the hammer. This will avoid accidental injury in the unlikely event of firearm discharge. Lowering the hammer in this way should be done only when the chamber is empty.



Figure 1

LOADED CHAMBER INDICATOR

Springfield pistols sold after January, 2001 have a loaded chamber indicator. (See Figure 1.) The barrel slot allows you to observe whether a shell is in the chamber. When a shell is in the chamber the brass case can be seen clearly.



Figure 1



Caution! *Even though the chamber is empty there may be shells in the magazine. The firearm is not completely empty until both the chamber and magazine are empty.*

SPRINGFIELD'S INTEGRAL LOCKING SYSTEM (ILS™) US PAT.6269576

Warning: Do not remove the mainspring housing before reading instructions and using eye protection. The ILS™ has parts under spring pressure. If improperly disassembled, the mainspring cap will be forcefully ejected and could cause injury to you or a bystander.

Caution: The ILS™ is designed to lock the pistol when stored or left unattended. It is not intended to replace any of the existing safety features.

ILS™ Operation

Locate the ILS™ switch on your mainspring housing.
(See Figure 13)

1. If the holes are vertical (stacked) the firearm is not locked. (See Fig. 13-1) To activate the ILS™ and lock your firearm, follow these steps. Point the firearm in a safe direction. Unload the gun. (See page 20) Fully lower the hammer (see page 22). Insert the key and turn clockwise until the holes are horizontal (side-by-side). The ILS™ is now activated and the firearm is locked. (See Fig. 13-2)

Note: The ILS™ requires firm pressure to operate, but do not over-torque.

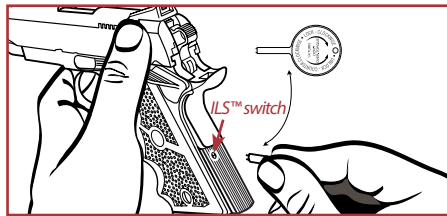

Figure 13

2. If the holes are horizontal (side-by-side) the gun is locked. To unlock, follow these steps.

- Point the firearm in a safe direction.
- Insert the key and turn counter-clockwise until the holes are vertical or stacked. (see Fig. 13-3)

Before cocking the firearm make sure it is unloaded.

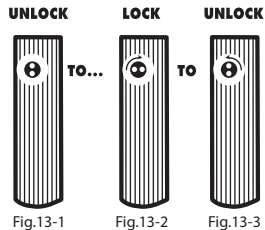

Fig.13-1

Fig.13-2

Fig.13-3

SPRINGFIELD'S INTEGRAL LOCKING SYSTEM (ILS™) US PAT.6269576

Removing the Mainspring Housing with ILS™

Caution: Always be sure the firearm is unloaded before proceeding.

1. With the hammer full down, deactivate the ILS™. The holes should be vertical (or stacked). (Fig. 13-1)
2. Wrap a heavy-duty rubber band around the grip safety until it is completely depressed. Doing so will maintain the alignment of the sear spring and negate further disassembly of the firearm. (Fig. 14)
3. Cock the hammer to the full cocked position.
4. Insert takedown pin into takedown hole. (Fig. 14)
5. Slowly lower the hammer to the full-down (fired) position.
6. With a proper punch, drive out the mainspring housing retaining pin.
7. Remove the mainspring housing.

Caution: Do not remove the takedown pin until the mainspring housing is reinstalled.

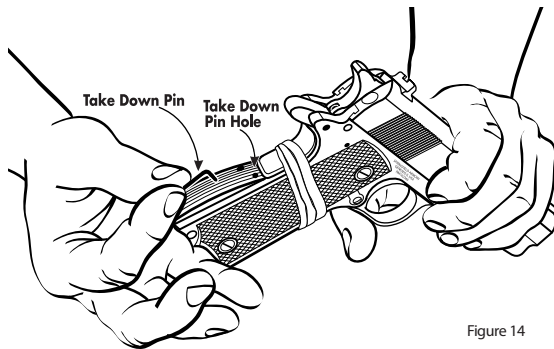

Figure 14

SPRINGFIELD'S INTEGRAL LOCKING SYSTEM (ILS™) US PAT.6269576

Disassembly of the Mainspring Housing with ILS™

Do not attempt this procedure unless you have considerable experience in firearms disassembly.

1. Place mainspring housing in a vice.
2. With a suitable punch, depress the ILS™ spring cap and hold it down. (Figure 15-1)
3. While continuing to depress the ILS™ spring cap, remove the takedown pin. (Fig. 15-2)
4. Slowly and carefully release the pressure on the spring cap allowing it to move out of the mainspring housing. (Fig. 15-3)
5. After the spring cap has been removed, the mainspring and mainspring retainer can be removed.

Caution: Do not turn the locking pin when the ILS™ is disassembled. The system may be reassembled only with the ILS™ pin deactivated (with the holes vertical or stacked).

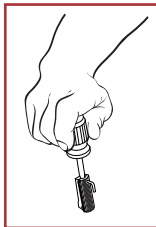

Fig. 15-1

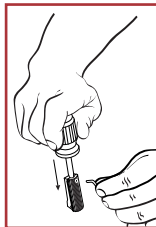

Fig. 15-2

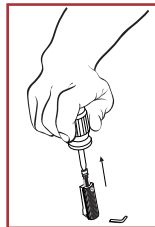

Fig. 15-3



This procedure requires extreme caution. The ILS™ spring cap is under extreme pressure and will be ejected if you fail to perform the disassembly properly. Use extreme care and wear eye protection.

SPRINGFIELD'S INTEGRAL LOCKING SYSTEM (ILS™) US PAT.6269576

Reassembly of the Mainspring Housing with ILS™

1. Assemble the mainspring cap, mainspring, and mainspring retainer then insert into the mainspring housing. (See Figure 16)
2. Carefully depress the cap far enough to allow you to reinstall the takedown pin. (See Fig.16-1).
3. Carefully and slowly release the pressure on the spring cap until the takedown pin captures it.

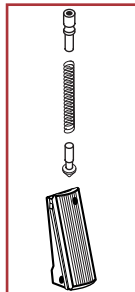

Figure 16

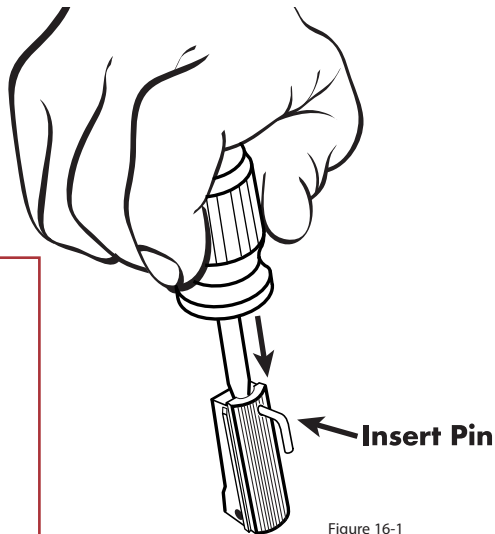

Figure 16-1

SPRINGFIELD'S INTEGRAL LOCKING SYSTEM (ILS™) US PAT.6269576

Replacing the Mainspring Housing with ILS™

1. Slide the mainspring housing into place and reinsert the mainspring housing retaining pin.
2. Cock the hammer to a full cock position.
3. Remove the takedown pin.
4. Remove the rubberband from the grip safety.
5. Lower the hammer to the full down position.

The mainspring housing with ILS™ is now installed.

LOADING/PREPARING TO FIRE

1. Place the EMPTY magazine in the magazine well, located in bottom of pistol grip. Make sure the magazine is EMPTY or you will inadvertently load the firearm. Push firmly enough on bottom of magazine to make sure it is properly seated. A distinctive “click” will confirm the magazine has been properly inserted. Pull the slide all the way to the rear, until it locks back.
2. Depress magazine release and remove magazine. Place rim of first cartridge on front of follower, then push down on the follower and slide cartridge under the lips of the magazine and to the rear. Load successive rounds the same way. Use only clean, dry, original, high-quality, commercially manufactured ammunition.
3. Re-insert magazine into magazine well, located in bottom of pistol grip. Push firmly enough on bottom of magazine to make sure it is properly seated.

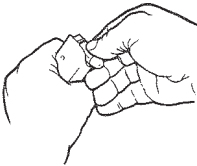

4. Point firearm in a safe direction, keep finger off trigger and out away from trigger guard. Pull slide back and release slide smartly to allow slide to move forward and load a shell from the magazine into the chamber.



Always load ammo from the magazine, never place cartridges directly in the chamber.



Never touch the trigger when loading or unloading the firearm. Never load a firearm in your house or car. Only at a firing range.

FIRING

Point gun in a safe direction at all times

If you have never fired a gun before, practice without live ammunition before your first shot. Then load only **one** cartridge into the magazine for your first live ammunition firing.

1. Load shell into chamber from magazine and engage the thumb safety.
2. Grasp grip of pistol firmly. (A loose grip may cause the pistol to malfunction.) The pressure from the hand will disengage grip safety located at top of rear grip area.
3. Move thumb safety down taking gun off safety.
Caution: The gun is now ready to fire. Be prepared for noise and recoil when pistol fires.
4. Aim gun at target by aligning sights.
5. Lightly place finger on trigger, and slowly squeeze trigger. Spent cartridge is expelled up and to the right.

6. Pistol will automatically be ready to fire again after each shot until all cartridges loaded in magazine have been fired.
7. When last cartridge has been fired, slide will lock open and remain to rear.



Improperly loading the 1911 by manually inserting a round in the chamber may cause accidental discharge. Always load the pistol using the magazine. When loading the pistol, always point the muzzle in a safe direction.

FRONT FIBER OPTIC INSTALLATION



WARNING: Make sure the firearm is completely unloaded, magazine removed and chamber clear.

INSTALLATION

- With a suitable heat source; i.e., Butane lighter, carefully begin to melt one end of the filament by positioning it close to the flame until a bulb forms the same size as the pocket in the serrated face of the front sight. **DO NOT LET THE FILAMENT TOUCH THE FLAME AS THIS WILL CLOUD THE BULB** (See Figure 20-1).
- Insert the filament into the sight from the serrated face of the sight and pull the filament through the sight until the bulb rests in the pocket (See Figure 20-2).
- If the bulb is larger than the pocket, cut off the bulb only and repeat the melting process until the bulb fits properly.
- Now cut the filament with a razor blade or fingernail clippers approximately 1/16 of an inch longer than the sight. Using the same melting process, form a bulb on the muzzle end of the sight locking the fiber optic filament in place (See Figure 20-3).



20 Figure 20-1

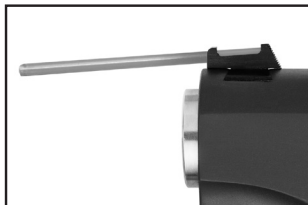

Figure 20-2



Figure 20-3

UNLOADING

If slide is already in “locked back” position:

1. Point gun in safe direction.
2. Press magazine release button to remove magazine.
3. From top and rear, carefully inspect chamber to make sure it is empty (Figure 21-1).
4. Hold slide, disengage slide stop, ease slide forward.

Notice: *The slide of a 1911-A1 pistol should never be released on an empty chamber; especially one which has had an action job. Releasing the slide on an empty chamber causes damage to the breech face on the barrel and undue stress on all action parts, including the hammer and the sear. This will ruin the action job performed on your pistol.*

5. Carefully lower hammer as described in the **HAMMER LOWERING** section. (Figure 21-2)

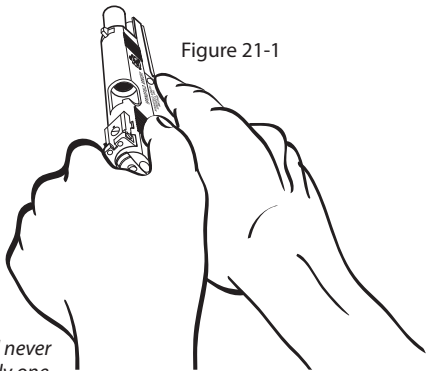

Figure 21-1

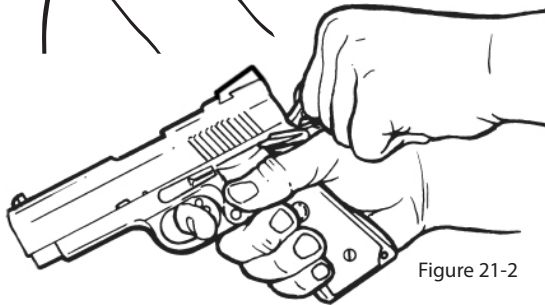

Figure 21-2



Pistol is not empty or unloaded until the chamber is empty and the magazine removed.

UNLOADING

If slide is forward and hammer is cocked:

1. Point gun in safe direction.
2. Engage thumb safety.
3. Press magazine release button to remove magazine.
4. Disengage thumb safety.
5. Pull slide fully to rear to eject any cartridge remaining in chamber.
6. While holding slide in rearward (open) position, carefully inspect chamber making sure it is empty (Figure 22-2).
7. Slowly release slide, allowing it to return to forward position.
8. Carefully lower hammer as described in **HAMMER LOWERING** section (Figure 22-2).

When magazine has been removed and when chamber is empty, a gun lock can be installed or the ILS™ may be activated (ILS™ not on all models). Pistol can now be safely stored in a secure place.

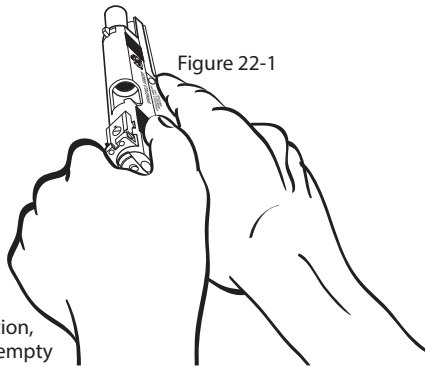

Figure 22-1

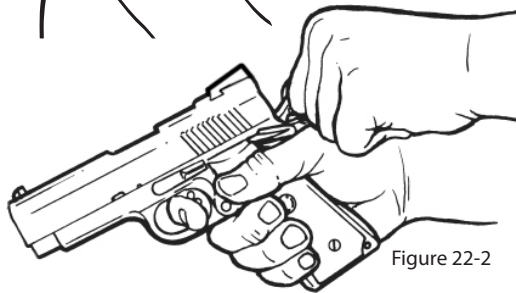

Figure 22-2



Pistol is not empty or unloaded until the chamber is empty and the magazine removed. Never touch the trigger when loading or unloading the pistol.

HAMMER LOWERING

1. Point gun in safe direction and ensure pistol is unloaded (Figure 23-1).
2. Firmly hold gun, depressing grip safety.
3. Using non-shooting hand, firmly grasp hammer with thumb and forefinger (Figure 23-2).
4. Be prepared for hammer movement. Squeeze trigger.
5. *Slowly* lower hammer with thumb and forefinger until it is fully forward.
6. Release trigger. (If the trigger is released early the gun may be on the Safety Stop.)

Note: Always keep and carry your pistol with an empty chamber and with the hammer forward (down) until you intend to shoot, so your pistol cannot be fired unintentionally.



Caution: If pistol is loaded, gun may discharge if the hammer slips from your grip during this procedure.

Figure 23-1

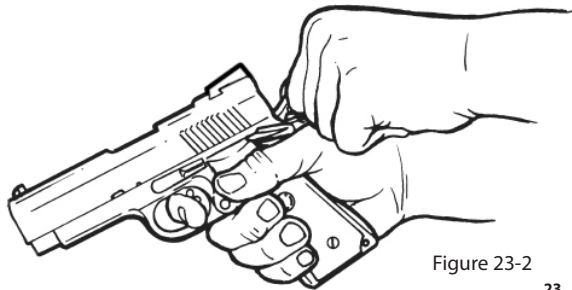
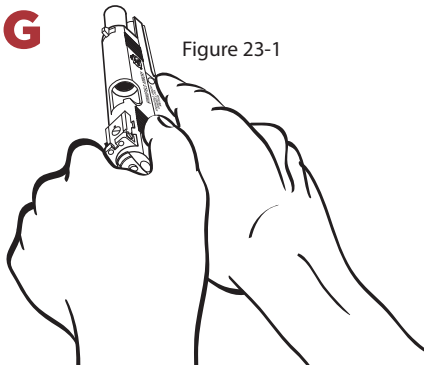

Figure 23-2

MALFUNCTION WARNING!

If cartridge hangs up, jams or binds when being chambered from magazine into chamber, do not attempt to force it into chamber by pushing or striking slide.

1. What to do:
 - Point gun in a safe direction.
 - Remove magazine.
 - Pull back on slide and allow cartridge to fall from gun.
 - If cartridge does not fall free, pull slide back and lock it back.
 - Carefully dislodge cartridge.
 - If cartridge cannot be removed, carefully store your gun and take it to a gunsmith.
2. Most failures of cartridge to feed or chamber are the result of a damaged magazine, improper gun handling or defective ammunition.
3. Whatever the cause, a jammed cartridge can be a dangerous situation. Should shell be discharged while out of chamber, cartridge will rupture and fragments will be blown out of pistol with sufficient force to cause injury.

If any information in this manual is not clear, call Springfield's Consumer Safety Department at (309) 944-5631 for assistance.



Always wear eye and ear protection when using any firearm. Safety and instruction manuals are available from Springfield, Inc.



**Always have gun pointed in a safe direction.
Failure to obey safety information may result in injury to you or others.**

TO ELIMINATE MALFUNCTIONS

1. Change type/brand of ammunition and/or magazine.
2. If changing to another type/brand of ammunition and/or magazine does not at once result in smooth feeding of cartridges from magazine to chamber, the following steps should be taken:
 - Make certain chamber and magazine are unloaded. Magazine should be removed first. Check chamber to be sure it and magazine well are clear of cartridges.
 - Thoroughly clean magazine, paying particular attention to removing accumulated grease. Thoroughly clean breech mechanism of pistol. Use a bristle brush and solvent to remove grease and fouling from breech face, extractor, chamber and feed ramp. (See **CARE AND CLEANING** section for detailed instruction.)
 - Check that magazine spring tension is adequate. The spring should hold the follower tightly against the lips of the magazine.
 - Check that magazine lips are free of nicks and burrs and are not deformed.
 - Remove excess oil and solvent from all cleaned components, load magazine and try pistol again.



Proceed slowly and exercise caution to prevent the discharge of a jammed cartridge. The discharge of a jammed cartridge could cause serious injury to you or bystanders.

SECTION 1: DISASSEMBLY OF FULL-SIZE MODELS



WARNING

If you decide to disassemble your Springfield pistol, do so properly. Improper disassembly and assembly will create unsafe conditions that could result in injury or death or a gun that simply will not work. Don't take chances. Do not attempt to disassemble this or any other firearm until you have received training and instructions from a competent gunsmith.

SECTION 1: DISASSEMBLY

FULL-SIZE MODELS

Before performing any cleaning or maintenance, make sure the firearm is completely unloaded (this includes the magazine and chamber). Wear eye protection.

Step 1 - Magazine Removal & Chamber Check

Point gun in a safe direction.

1. Press magazine catch and remove magazine.
2. Pull slide backwards and check that no cartridge is in the chamber.
3. Release slide allowing it to go to forward position.

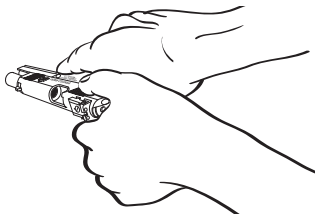

Step 2 - Recoil Spring Removal

Point gun in a safe direction.

1. If your pistol contains a 2 piece full length guide rod, use a 5/32 Allen wrench to remove the front portion of guide rod.
2. Grip slide behind the front sight, resting pistol butt on top of your knee.
3. Move slide rearward, approximately 1/2 inch, grasp firmly to hold in place, and depress recoil spring plug with thumb.
4. Point muzzle away from face and rotate barrel bushing clockwise.
5. Do not rotate bushing off of plug unless you have control of plug and spring.

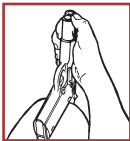

2.



3.



WARNING: Point muzzle away from face to prevent injury in the event plug is ejected by spring.



CAUTION: Never allow live ammunition in the area while you are maintaining your firearm.

SECTION 1: DISASSEMBLY

FULL-SIZE MODELS

Step 3

Cautiously allow plug and recoil spring to move forward.

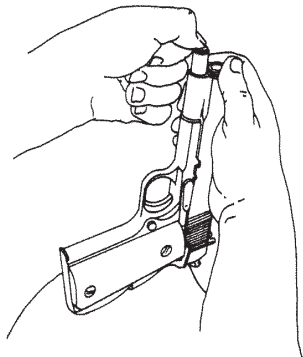

Step 4 - Slide Stop Removal

1. Align disassembly notch on slide with slide stop.
2. Press slide stop shaft on right side of frame and remove slide stop by pulling it out of left side of frame.

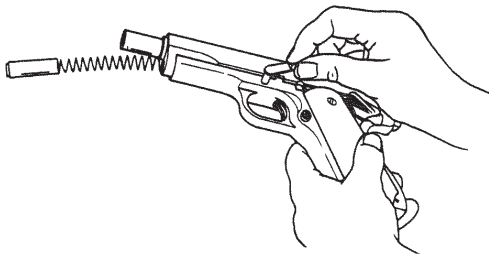

CAUTION: Never allow live ammunition in the area while you are maintaining your firearm.



BE SAFE! Be sure pistol is unloaded before beginning disassembly! Wear eye protection, gun contains spring-loaded parts.



SECTION 1: DISASSEMBLY

FULL-SIZE MODELS

Step 5 - Slide Removal

Pull slide forward in its guides and remove slide. Barrel, barrel bushing, recoil spring plug, recoil spring and guide will come with it.

Step 6 - Recoil Spring Components Removal

Remove recoil spring and guide through back side.

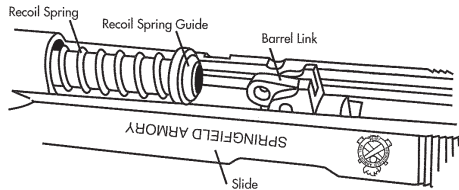

Always wear eye and ear protection when using any firearm. Safety and instruction manuals are available from Springfield, Inc.

Step 7 - Barrel Removal

1. Rotate barrel bushing to left of slide and remove it through the front.
2. Tilt barrel link forward and remove barrel from front of slide.

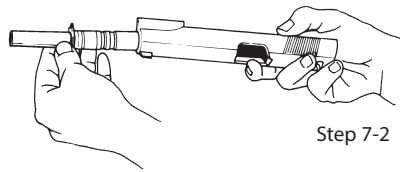
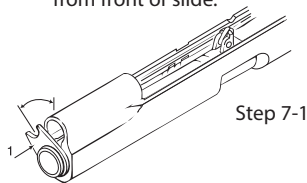

CAUTION: Never allow live ammunition in the area while you are maintaining your firearm.



BE SAFE! Be sure pistol is unloaded before beginning disassembly! Wear eye protection, gun contains spring-loaded parts.

SECTION 1: DISASSEMBLY

FULL-SIZE MODELS

Note: There are many after-market or accessory items for 1911 style pistols. After market accessories may void warranty. If you are not the original owner of your pistol or you are unclear on disassembling your pistol, call or write to Springfield Armory.

Call Springfield Consumer Safety Department at
(309) 944-5631

or write c/o:

Springfield Inc.
420 West Main Street
Geneseo, IL 61254



Improper disassembly may damage the firearm. Always consult an experienced gunsmith if you experience any difficulty or have any questions concerning assembly procedure.



CAUTION: Never allow live ammunition in the area while you are maintaining your firearm.



Always wear eye and ear protection when using any firearm. Safety and instruction manuals are available from Springfield, Inc.



BE SAFE! Be sure pistol is unloaded before beginning disassembly! Wear eye protection, gun contains spring-loaded parts.

SECTION 1: ASSEMBLY

FULL-SIZE MODELS

Assemble by reversing the order of disassembly.

Note: When replacing recoil assembly (*Step 6*), be certain the recoil spring guide and recoil spring are aligned with the barrel before inserting in slide. Be sure to flip barrel link forward before installing slide assembly. Slide stop shaft **must** go through hole in barrel link.

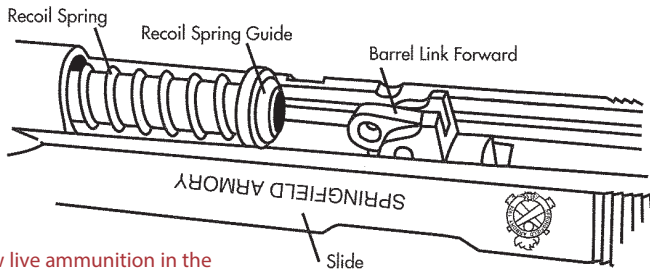

CAUTION: Never allow live ammunition in the area while you are maintaining your firearm.



Always wear eye and ear protection when using any firearm. Safety and instruction manuals are available from Springfield, Inc.



WARNING

An improperly assembled firearm is dangerous and should not be fired. Always consult an experienced gunsmith if you experience any difficulty or have any questions concerning assembly procedure.



BE SAFE! Be sure pistol is unloaded before beginning disassembly! Wear eye protection, gun contains spring-loaded parts.

SECTION 2: DISASSEMBLY OF TRP™ OPERATOR® MODELS

WARNING

If you decide to disassemble your Springfield pistol, do so properly. Improper disassembly and assembly will create unsafe conditions that could result in injury or death or a gun that simply will not work. Don't take chances. Do not attempt to disassemble this or any other firearm until you have received training and instructions from a competent gunsmith.

SECTION 2: DISASSEMBLY

TRP™ OPERATOR® MODELS

Before performing any cleaning or maintenance, make sure the firearm is completely unloaded (this includes the magazine and chamber). Wear eye protection.

Step 1 - Magazine Removal & Chamber Check

Point gun in a safe direction.

1. Press magazine catch and remove magazine.
2. Pull slide backwards and check that no cartridge is in the chamber.



Improper disassembly may damage the firearm. Always consult an experienced gunsmith if you experience any difficulty or have any questions concerning assembly procedure.



CAUTION: Never allow live ammunition in the area while you are maintaining your firearm.



Always wear eye and ear protection when using any firearm. Safety and instruction manuals are available from Springfield, Inc.

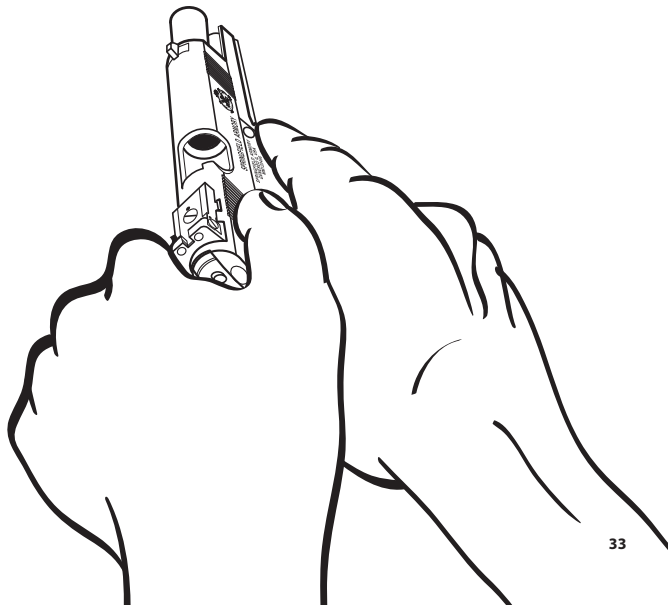

SECTION 2: DISASSEMBLY

TRP™ OPERATOR® MODELS

Step 2 - Slide Stop Removal

1. Align disassembly notch on slide with slide stop.
2. Press slide stop shaft on right side of frame.
3. Remove slide stop from left side.
4. Pull slide assembly forward off frame.

Step 3 - Recoil Spring Assembly Removal

1. Push recoil spring assembly forward to expose a small, pin-sized hole. (Fig. 33-1)
2. Insert the provided pin (or cut a paper clip so that it extends 1/16" on both sides of guide rod) into pin hole.
3. Remove recoil spring housing from the rear of the slide. (Fig. 33-2)
4. Remove the barrel from the front of the slide.



CAUTION: Never allow live ammunition in the area while you are maintaining your firearm.



Always wear eye and ear protection when using any firearm. Safety and instruction manuals are available from Springfield, Inc.

Figure 33-1

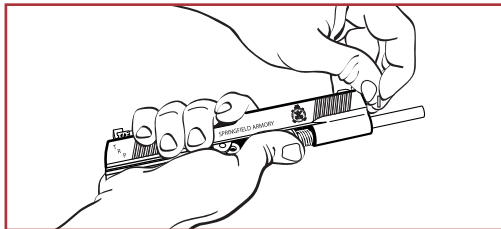
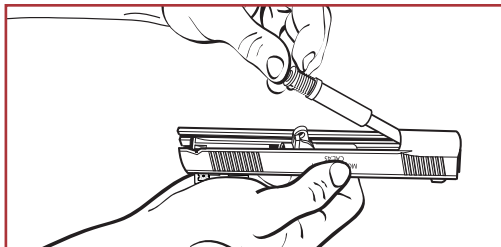

Figure 33-2



BE SAFE! Be sure pistol is unloaded before beginning disassembly! Wear eye protection, gun contains spring-loaded parts.

SECTION 2: ASSEMBLY

TRP™ OPERATOR® MODELS

Assemble by reversing the order of disassembly.

Note: Be sure to flip barrel link forward before installing barrel into slide.



An improperly assembled firearm is dangerous and should not be fired.

Always consult an experienced gunsmith if you experience any difficulty or have any questions concerning assembly procedure.



CAUTION: Never allow live ammunition in the area while you are maintaining your firearm.



Always wear eye and ear protection when using any firearm. Safety and instruction manuals are available from Springfield, Inc.



BE SAFE! Be sure pistol is unloaded before beginning disassembly! Wear eye protection, gun contains spring-loaded parts.



Model 1911-A1 Pistols are classified firearms and dangerous weapons. Injury or death to you or others may result from unsafe or improper use.

SECTION 3: DISASSEMBLY OF V-12, V-16, & LONG SLIDE MODELS



WARNING

If you decide to disassemble your Springfield pistol, do so properly. Improper disassembly and assembly will create unsafe conditions that could result in injury or death or a gun that simply will not work. Don't take chances. Do not attempt to disassemble this or any other firearm until you have received training and instructions from a competent gunsmith.

SECTION 3: DISASSEMBLY

V-12, V-16, & LONG SLIDE MODELS

Before performing any cleaning or maintenance, make sure the firearm is completely unloaded (this includes the magazine and chamber). Wear eye protection.

Step 1 - Magazine Removal & Chamber Check

Point gun in a safe direction.

1. Press magazine catch and remove magazine.
2. Pull slide backwards and check that no cartridge is in the chamber.

 **BE SAFE!** Be sure pistol is unloaded before beginning disassembly! Wear eye protection, gun contains spring-loaded parts.

 **WARNING**

An improperly assembled firearm is dangerous and should not be fired. Always consult an experienced gunsmith if you experience any difficulty or have any questions concerning assembly procedure.

 **CAUTION:** Never allow live ammunition in the area while you are maintaining your firearm.



SECTION 3: DISASSEMBLY

V-12, V-16, & LONG SLIDE MODELS

Step 2 - Full Length Guide Rod Removal

Some V-series and Long Slide Models contain full-length guide rods.

1. Use a 5/32 Allen wrench to remove the front portion of the guide rod.

Step 3 - Slide Stop Removal

1. Align disassembly notch with slide stop.
2. Press slide stop shaft on right side of slide and remove slide stop by pulling it out of left side of frame.

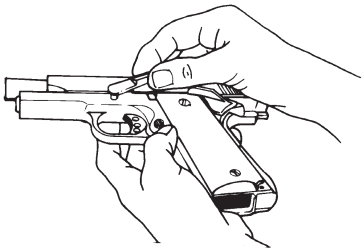

Step 4 - Slide Removal

Pull slide forward in its guides and remove slide. Barrel, recoil spring plug, recoil spring, and guide will come with it.

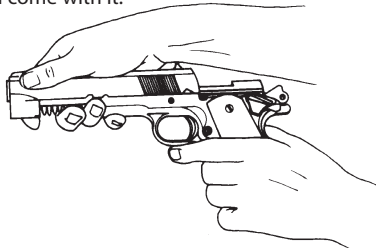

BE SAFE! Be sure pistol is unloaded before beginning disassembly! Wear eye protection, gun contains spring-loaded parts.



Recoil spring guide could eject out from the side as slide is removed. To keep the recoil spring from ejecting sideways, hold fingers around slide while moving it forward.



CAUTION: Never allow live ammunition in the area while you are maintaining your firearm.

SECTION 3: DISASSEMBLY

V-12, V-16, & LONG SLIDE MODELS

Step 4 - Recoil Spring Components Removal

Remove guide, recoil spring, and its plug through back of slide.

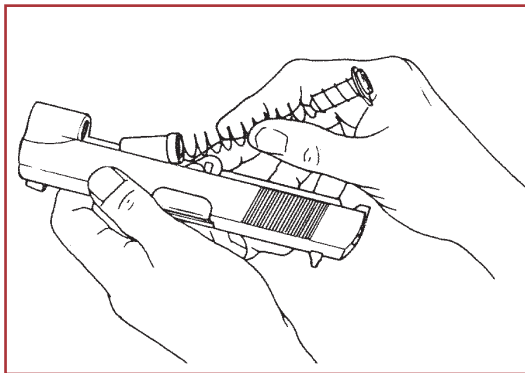

 **CAUTION:** Never allow live ammunition in the area while you are maintaining your firearm.

Step 5 - Barrel Removal

Tilt barrel link forward and remove barrel through front of slide.

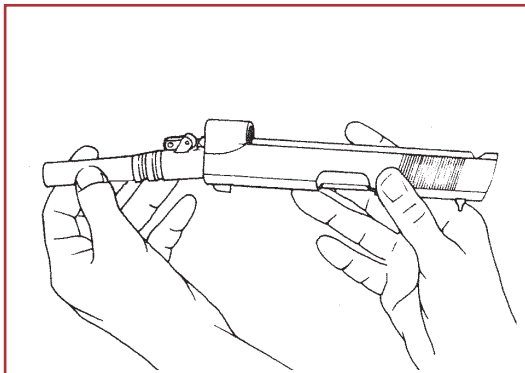

 **BE SAFE!** Be sure pistol is unloaded before beginning disassembly! Wear eye protection, gun contains spring-loaded parts.

SECTION 3: ASSEMBLY

V-12, V-16, & LONG SLIDE MODELS

Assemble by reversing the order of disassembly.

Note: When replacing recoil assembly (Step 4), be certain barrel clearance cuts on recoil spring guide are aligned before inserting in slide. Be sure to flip barrel link forward before installing slide assembly.

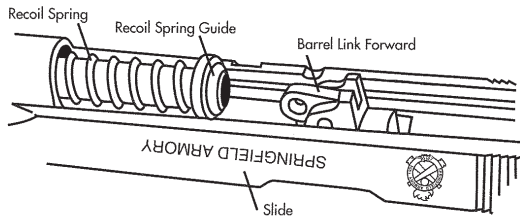

CAUTION: Never allow live ammunition in the area while you are maintaining your firearm.



BE SAFE! Be sure pistol is unloaded before beginning disassembly! Wear eye protection, gun contains spring-loaded parts.



WARNING

An improperly assembled firearm is dangerous and should not be fired. Always consult an experienced gunsmith if you experience any difficulty or have any questions concerning assembly procedure.

SECTION 4: DISASSEMBLY of MICRO COMPACT, ULTRA COMPACT, V-10, COMPACT, EMP® 3", EMP® 4" & CHAMPION™ MODELS



WARNING

If you decide to disassemble your Springfield pistol, do so properly. Improper disassembly and assembly will create unsafe conditions that could result in injury or death or a gun that simply will not work. Don't take chances. Do not attempt to disassemble this or any other firearm until you have received training and instructions from a competent gunsmith.

SECTION 4: DISASSEMBLY

MICRO-COMPACT, ULTRA COMPACT, V-10, COMPACT, EMP® 3", EMP® 4" & CHAMPION MODELS

Before performing any cleaning or maintenance, make sure the firearm is completely unloaded (this includes the magazine and chamber). Wear eye protection.

Step 1 - Magazine Removal & Chamber Check

Point gun in a safe direction.

1. Press magazine catch and remove magazine.
2. Pull slide backwards and check that no cartridge is in the chamber.
3. Release slide allowing it to go to forward position.

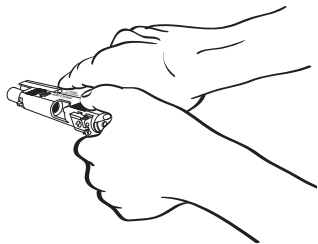

BE SAFE! Be sure pistol is unloaded before beginning disassembly! Wear eye protection, gun contains spring-loaded parts.



CAUTION: Never allow live ammunition in the area while you are maintaining your firearm.



WARNING: Point muzzle away from face to prevent injury in the event plug is ejected by spring.

SECTION 4: DISASSEMBLY

MICRO-COMPACT, ULTRA COMPACT, V-10, COMPACT, EMP® 3", EMP® 4" & CHAMPION™ MODELS

NOTE: YOUR FIREARM MAY HAVE ONE OF THE TWO RECOIL SYSTEMS LISTED.

Always Point gun in a safe direction.

Step 2 - Dual Recoil Spring Disassembly

1. Lock slide to the rear. (See fig. 43-1)
2. Firmly "snap" the takedown piece over the exposed portion of the guide rod between inner spring plug and guide rod cap. (See fig. 43-2)
3. Grasp slide, release slide lock and slowly allow slide to go forward. Align disassembly notch on slide with stop. Remove the slide stop.
4. Carefully remove the slide assembly from the receiver.
5. The recoil spring system can now be removed from the slide. (See fig. 43-3)
6. The barrel can now be removed from the front of the slide.
7. Disassembly is now complete.

Step 2 - Flat Wire Recoil Spring Disassembly

1. Lock slide to the rear.
2. Install flat wire takedown piece. (See fig. 43-4)
3. Align disassembly notch on slide with slide stop.
4. Remove slide stop and slowly remove slide from receiver keeping in mind that the slide is under spring pressure until it clears the receiver.
5. The recoil spring system can now be removed from the slide. (See fig. 43-5)
6. Disassembly is now complete.

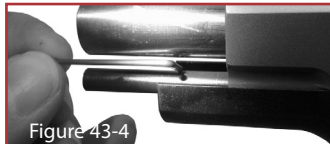
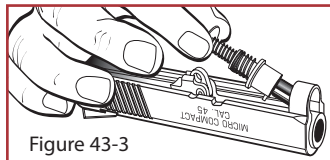
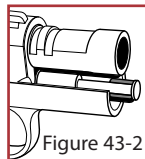
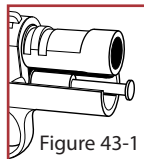

ALTERNATE METHOD FOR DISASSEMBLY

Dual Recoil Spring Disassembly

1. Retract slide to the takedown notch.
2. Align disassembly notch on slide with slide stop.
3. Remove slide stop and slowly remove slide from receiver keeping in mind that the slide is under spring pressure until it clears the receiver.
4. With the bottom of the slide facing up, press the guide rod head forward until enough of the rod is exposed and firmly snap the takedown piece over the rod. (See fig. 44-1 and 2)
5. The slide assembly can now be disassembled as previously laid out. (Described in section 4, Step 2).



Figure 44-1



Figure 44-2



BE SAFE! Be sure pistol is unloaded before beginning disassembly! Wear eye protection, gun contains spring-loaded parts.



CAUTION: Never allow live ammunition in the area while you are maintaining your firearm.

SECTION 4: ASSEMBLY

MICRO-COMPACT, ULTRA COMPACT, V-10, COMPACT, EMP® 3", EMP® 4" & CHAMPION™ MODELS

Assemble by reversing the order of disassembly.

Note: Be sure to flip barrel link forward before installing barrel into slide.



An improperly assembled firearm is dangerous and should not be fired.

Always consult an experienced gunsmith if you experience any difficulty or have any questions concerning assembly procedure.



BE SAFE! Be sure pistol is unloaded before beginning disassembly! Wear eye protection, gun contains spring-loaded parts.



CAUTION: Never allow live ammunition in the area while you are maintaining your firearm.



Model 1911-A1 Pistols are classified firearms and dangerous weapons. Injury or death to you or others may result from unsafe or improper use.

CAUTION

Never leave pistol cocked and ready to fire as the fire condition is extremely dangerous. Pistol could easily be accidentally discharged causing injury, death, or damage to property.

Proper use will prevent the gun from being fired accidentally. No mechanical device is a substitute for safe gun handling. Every household member should be trained in safe gun handling practices. Minor children should be given the Eddie Eagle Safety Program from the NRA. Call 703-267-1000 for the video.



CAUTION: FIREARMS SHOULD ALWAYS BE LOCKED AND STORED IN COMPLETE COMPLIANCE WITH ALL APPLICABLE LAWS AND REGULATIONS.



Always wear eye and ear protection when using any firearm. Safety and instruction manuals are available from Springfield, Inc.

PORTED BARREL SAFETY INSTRUCTIONS

Warnings, Ammunition Restrictions, and Maintenance

Completely read this safety manual before using a ported barrel pistol. Transfer this manual to any subsequent owner or user of the pistol. If you are inexperienced in the handling of firearms, obtain expert instruction before attempting to shoot. Neither this manual nor this product can take the place of proper instruction in the safety aspects of shooting, the use of firearms, and the use of a firearm for self-defense. Severe injury to hands, eyes, face, other persons or property will occur with improper use of a ported pistol.

Safety Notes

Always use eye and ear protection when shooting or when in close proximity to shooting. A ported barrel pistol, in common with most pistols using muzzle brake devices, produces greater noise than normal pistols and this poses a danger to hearing. Never position any part of the body over or near the exhaust ports. Never cycle the slide with your hands over the exhaust ports. Never point a gun at anything you do not intend to shoot. If the ported pistol is drawn rapidly it must not be discharged in proximity to the holster or the shooter's eyes, legs, arms, clothing or bystanders. Do not shoot a ported barrel pistol from the hip. The blast from the exhaust ports can cause injury or property damage several feet away. Use caution when shooting to avoid overhead objects that may be damaged by the blast from the barrel exhaust ports.



Always point gun in a safe direction.
Keep your gun unloaded until you are ready to shoot.

PORTED BARREL SAFETY INSTRUCTIONS

Ammunition

Use only fresh factory ammunition such as Winchester or Federal. DO NOT use handloads, reloads, or remanufactured ammunition in your Springfield firearm. Only shoot cartridges of the caliber engraved on the barrel. DO NOT use shot cartridges or any ammunition which is loaded with a frangible projectile or any ultra-light weight projectile at elevated velocities, or any wooden or plastic projectile.

Caution

Fragments of the metal jackets on jacketed bullets may be propelled through the exhaust ports with great force and have the potential to cause injury or property damage at a distance of several feet. The misuse of any of the ammunition described above may result in injury, property damage, or both.

Maintenance

Accumulated debris in the barrel exhaust ports may result in damage to the pistol or injury to the shooter. With the gun unloaded, regularly inspect the bore and exhaust ports for dirt and debris. Never discharge the firearm when any form of debris is present in the barrel or exhaust ports.



Always wear eye and ear protection when using any firearm. Safety and instruction manuals are available from Springfield, Inc.

POINT OF AIM

Point of Impact

Shooters may use a “point of aim” sight picture at 25 yards. This means that, at 25 yards the bullet should impact the target at the point visible at the top of the front sight. Shooters may also use a “6 o’clock” sight picture to strike the center of the target. Springfield Armory® pistols are designed to use the “6 o’clock” sight picture at 25 yards. However, some pistols may shoot “point of aim” at 25 yards depending on shooter and ammunition.

Note: 1911-A1 Pistols less than 5 inches are designed to use standard pressure ball ammo and self-defense loads. +P ammunition is not recommended. Use only clean, dry, original, high-quality, commercially manufactured ammunition.

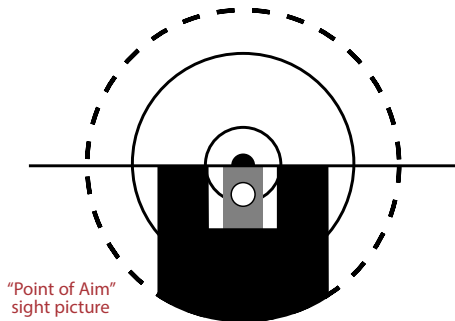

“Point of Aim”
sight picture

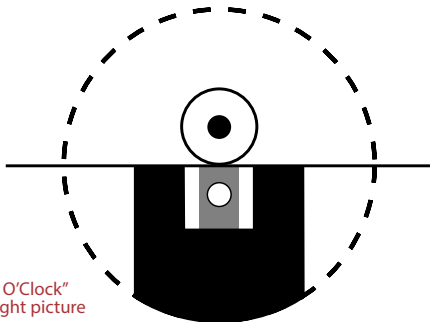

“6 O’Clock”
sight picture

EXPLODED VIEW & PARTS LIST

MIL-SPEC MODELS

- | | | | | | |
|-----|--------|---------------------------------|-----|--------|-------------------------------|
| 1. | PI9911 | .45 Mil-Spec Frame | 2. | PX4546 | .45 Slide |
| 1a. | PI0037 | Slide Stop | 2a. | PI5350 | 3-Dot Front Sight, .180 |
| 1b. | PI0038 | Thumb Safety | 2b. | PI5341 | H.P. Fixed Rear Sight, 3-Dot |
| 1c. | PI0044 | Slide Stop Plunger | 2c. | PI0011 | Extra Power Firing Pin Spring |
| 1d. | PI0042 | Thumb Safety/Slide Stop Spring | 2d. | PI0910 | 9mm Titanium Firing Pin |
| 1e. | PI0043 | Safety Plunger | 2e. | PI4506 | .45 Extractor |
| 1f. | PI0041 | Plunger Tube | 2f. | PI4511 | .45 Firing Pin Stop |
| 1g. | PI0017 | Hammer Pin | 2g. | PI0032 | Recoil Spring Guide |
| 1h. | PI0015 | Grip Screw Escutcheon | 2h. | PI0030 | Recoil Spring (16 lb.) |
| 1i. | PI0026 | Mainspring Housing Retainer Pin | 2i. | PI0031 | Recoil Spring Plug |
| 1j. | PI4507 | .45 Ejector, Extended | 3. | PI3501 | .45 Barrel (Stainless) |
| 1k. | PI0005 | Disconnecter | 3a. | PI0004 | Barrel Link Pin |
| 1l. | PI0034 | Sear | 3b. | PI0003 | Barrel Link |
| 1m. | PI0027 | Magazine Catch | 3c. | PI3002 | Barrel Bushing (Stainless) |
| 1n. | PI0029 | Magazine Catch Spring | 4. | PI4523 | .45 7-Round Magazine |
| 1o. | PI0028 | Magazine Catch Lock | 5. | PI0020 | Arched Mainspring Housing |
| 1p. | PI5006 | Regular Spur Hammer | 5a. | SL0008 | ILS™ Locking Bolt |
| 1q. | PI0019 | Hammer Strut Pin | 5b. | PI0024 | Mainspring Retainer |
| 1r. | PI0018 | Hammer Strut | 5c. | PI0052 | Mainspring (28 lb.) |
| 1s. | PI5308 | Mil-Spec Trigger | 5d. | SL0007 | ILS™ Mainspring Cap |
| 1t. | PI0036 | Sear Spring | 5e. | SL0009 | ILS™ Plunger |
| 1u. | PH5066 | Grip Safety | 5f. | SL0010 | ILS™ Plunger Spring |
| 1v. | PI5143 | Black Plastic Grip (L.H.) | | | |
| 1w. | PI5144 | Black Plastic Grip (R.H.) | | | |
| 1x. | PI0014 | Grip Screw | | | |
| 1y. | PI0035 | Sear Pin | | | |
| 1z. | PI0008 | Ejector Pin | | | |

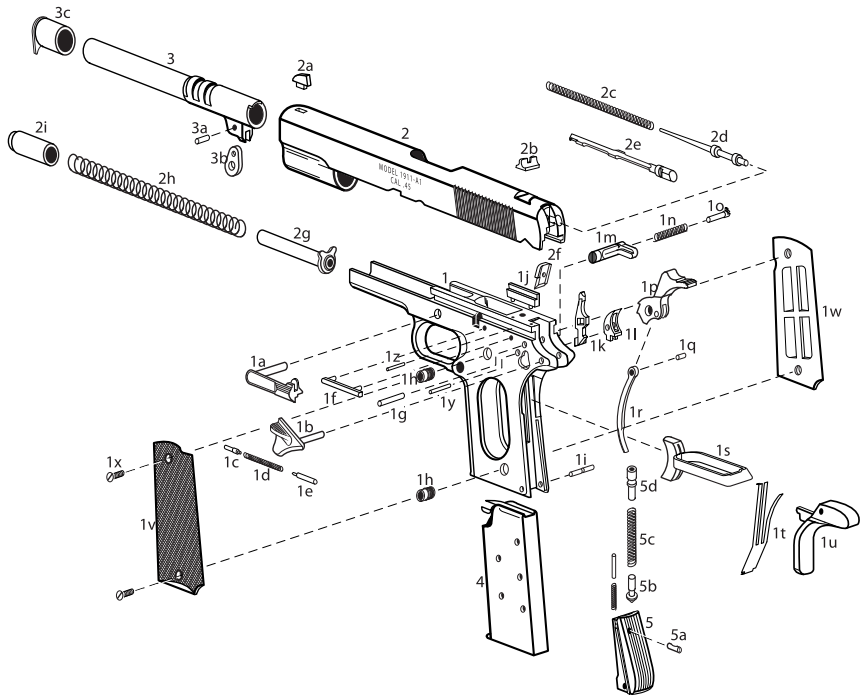

EXPLODED VIEW & PARTS LIST

"LOADED" MODELS

- | | | | | | |
|-----|--------|--|-----|---------|--|
| 1. | PI9911 | .45 "Loaded" Frame | 2. | PX4546 | .45 Slide |
| 1a. | PI0037 | Slide Stop | 2a. | PI5017 | Dovetail Front Sight |
| 1b. | PH5036 | Extended Thumb Safety | 2b. | PI4600M | Fixed Combat Rear Sight |
| 1c. | PI0044 | Slide Stop Plunger | 2c. | PI0011 | Extra Power Firing Pin Spring |
| 1d. | PI0042 | Thumb Safety/Slide Stop Spring | 2d. | PI0910 | 9mm Titanium Firing Pin |
| 1e. | PI0043 | Safety Plunger | 2e. | PI4506 | .45 Extractor |
| 1f. | PI0041 | Plunger Tube | 2f. | PI4511 | .45 Firing Pin Stop |
| 1g. | PI0017 | Hammer Pin | 2g. | PI5192 | National Match 2-piece Recoil Spring Guide |
| 1h. | PI0015 | Grip Screw Escutcheon | 2h. | PI0030 | Recoil Spring (16 lb.) |
| 1i. | PI0026 | Mainspring Housing Retainer Pin | 2i. | PI5198 | National Match Guide Plug (Stainless) |
| 1j. | PI4507 | .45 Ejector, Extended | | | |
| 1k. | PI0005 | Disconnecter | 3. | PI3501 | .45 Barrel (Stainless) |
| 1l. | PI0034 | Sear | 3a. | PI0004 | Barrel Link Pin |
| 1m. | PI0027 | Magazine Catch | 3b. | PI0003 | Barrel Link |
| 1n. | PI0029 | Magazine Catch Spring | 3c. | PI3002 | Barrel Bushing (Stainless) |
| 1o. | PI0028 | Magazine Catch Lock | | | |
| 1p. | PI5006 | Delta-Style Hammer | 4. | PI4523 | .45 7-Round Magazine |
| 1q. | PI0019 | Hammer Strut Pin | | | |
| 1r. | PI0018 | Hammer Strut | 5. | SL0005 | ILS™ Mainspring Housing |
| 1s. | PI5308 | National Match Aluminum Trigger | 5a. | SL0008 | ILS™ Locking Bolt |
| 1t. | PI0036 | Sear Spring | 5b. | PI0024 | Mainspring Retainer |
| 1u. | PH5066 | Beavertail Grip Safety | 5c. | PI0052 | Mainspring (28 lb.) |
| 1v. | PI5143 | Cocobolo Checkered Grip w/bevel (L.H.) | 5d. | SL0007 | ILS™ Mainspring Cap |
| 1w. | PI5144 | Cocobolo Checkered Grip w/bevel (R.H.) | 5e. | SL0009 | ILS™ Plunger |
| 1x. | PI0014 | Grip Screw | 5f. | SL0010 | ILS™ Plunger Spring |
| 1y. | PI0035 | Sear Pin | | | |
| 1z. | PI0008 | Ejector Pin | | | |

EXPLODED VIEW & PARTS LIST

HIGH CAPACITY MODELS

- | | | | |
|------------|---------------------------------|------------|-------------------------------------|
| 1. PH9900 | High-Capacity Frame | 2. PI4546 | .45 Slide |
| 1a. PI0037 | Slide Stop | 2a. PI5350 | 3-Dot Front Sight, .180 |
| 1b. PH5036 | Extended Thumb Safety | 2b. PI5341 | H.P. Fixed Rear Sight (3-Dot) |
| 1c. PI0044 | Slide Stop Plunger | 2c. PI0011 | Extra Power Firing Pin Spring |
| 1d. PI0042 | Thumb Safety/Slide Stop Spring | 2d. PI0910 | 9mm Titanium Firing Pin |
| 1e. PI0043 | Safety Plunger | 2e. PI4506 | .45 Extractor |
| 1f. PI0017 | Hammer Pin | 2f. PI4511 | Firing Pin Stop |
| 1g. PH0015 | Grip Screw Escutcheon | | |
| 1h. PI0026 | Mainspring Housing Retainer Pin | 3. PI3501 | .45 Barrel (Stainless) |
| 1i. PI4507 | .45 Ejectors, Extended | 3a. PI0004 | Barrel Link Pin |
| 1j. PI0005 | Disconnecter | 3b. PI0003 | Barrel Link |
| 1k. PI0034 | Sear | 3c. PI3002 | Barrel Bushing (Stainless) |
| 1l. PH0027 | Magazine Catch | | |
| 1m. PI0029 | Magazine Catch Spring | 4. PI5445 | .45 High Capacity Standard Magazine |
| 1n. PI0028 | Magazine Catch Lock | | |
| 1o. PI5006 | Delta Style Hammer | 5. SL0005 | ILS™ Mainspring Housing |
| 1p. PI0019 | Hammer Strut Pin | 5a. SL0008 | ILS™ Locking Bolt |
| 1q. PI0018 | Hammer Strut | 5b. PI0024 | Mainspring Retainer |
| 1r. PH0039 | High-Capacity Trigger | 5c. PI0052 | Mainspring (28 lb.) |
| 1s. PI0036 | Sear Spring | 5d. SL0007 | ILS™ Mainspring Cap |
| 1t. PH5066 | Beavertail Grip Safety | 5e. SL0009 | ILS™ Plunger |
| 1u. PH0006 | High-Capacity Grip (L.H.) | 5f. SL0010 | ILS™ Plunger Spring |
| 1v. PH0007 | High-Capacity Grip (R.H.) | | |
| 1w. PH0014 | High-Capacity Grip Screw | | |
| 1x. PI0035 | Sear Pin | | |
| 1y. PI0008 | Ejector Pin | | |

EXPLODED VIEW & PARTS LIST

"MICRO COMPACT" MODELS

- | | | | | | |
|------|--------|--|-----|---------|--|
| 1. | PI9980 | .45 "Micro-compact" Frame | 2. | PI4845 | .45 Micro-Compact Slide |
| 1a. | PI0037 | Slide Stop | 2a. | PI5016M | Dovetail Front Sight |
| 1br. | PH5114 | Extended Ambidextrous Thumb Safety (Right) | 2b. | PI4600M | Fixed Combat Rear Sight |
| 1bl. | PH5113 | Extended Ambidextrous Thumb Safety (Left) | 2c. | PI0011 | Extra Power Firing Pin Spring |
| 1c. | PI0044 | Slide Stop Plunger | 2d. | PI0910 | 9mm Titanium Firing Pin |
| 1d. | PI0042 | Thumb Safety/Slide Stop Spring | 2e. | PI4506 | .45 Extractor |
| 1e. | PI0043 | Safety Plunger | 2f. | PI0911 | 9MM Firing Pin Stop |
| 1f. | PI0041 | Plunger Tube | 2g. | PI5192 | National Match 2-piece Recoil Spring Guide |
| 1g. | PI0017 | Hammer Pin | 2h. | PI4834 | Micro-Compact Outer Recoil Spring |
| 1h. | PI4815 | Thin Line Grip Screw Escutcheon | 2i. | PI4831 | Micro-Compact Reverse Spring Plug |
| 1i. | PI0026 | Mainspring Housing Retainer Pin | 3. | PI4801 | .45 Barrel (Stainless) |
| 1j. | PI0907 | Micro-Compact Ejector, Extended | 3a. | PI0004 | Barrel Link Pin |
| 1k. | PI0005 | Disconnecter | 3b. | PI0003 | Barrel Link |
| 1l. | PI0034 | Sear | 4. | PI4726 | .45 Compact 6 Round Magazine |
| 1m. | PI0027 | Magazine Catch | 5. | SL0005 | ILS™ Mainspring Housing |
| 1n. | PI0029 | Magazine Catch Spring | 5a. | SL0008 | ILS™ Locking Bolt |
| 1o. | PI0028 | Magazine Catch Lock | 5b. | PI4724 | Mainspring Retainer |
| 1p. | PI5006 | Delta-Style Hammer | 5c. | SL0014 | Mainspring (23 lb.) |
| 1q. | PI0019 | Hammer Strut Pin | 5d. | SL0007 | ILS™ Mainspring Cap |
| 1r. | PI0018 | Hammer Strut | 5e. | SL0009 | ILS™ Plunger |
| 1s. | PI5308 | National Match Aluminum Trigger | 5f. | SL0010 | ILS™ Plunger Spring |
| 1t. | PI0036 | Sear Spring | | | |
| 1u. | PH5066 | Beavertail Grip Safety | | | |
| 1v. | PI5168 | Cocobolo Checkered Thin Line Grip w/bevel (L.H.) | | | |
| 1w. | PI5169 | Cocobolo Checkered Thin Line Grip w/bevel (R.H.) | | | |
| 1x. | PI4814 | Thin Line Grip Screw | | | |
| 1y. | PI0035 | Sear Pin | | | |
| 1z. | PI0008 | Ejector Pin | | | |

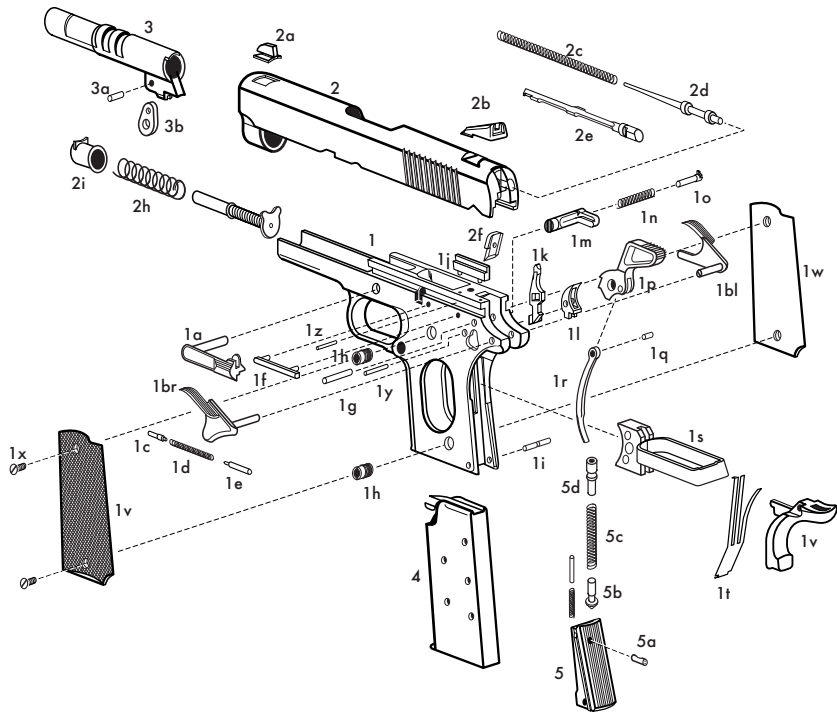

CABLE LOCK

- Step 1 - Point firearm in safe direction while keeping your finger off the trigger.
- Step 2 - Press magazine release and remove magazine.
- Step 3 - Pull slide fully to the rear and lock open.
- Step 4 - Check to see that no cartridge is in the chamber.
- Step 5 - Insert cable through the ejection port and out magazine well.
- Step 6 - Lock cable into cable lock.
- Step 7 - Grasp slide and ease forward.



CAUTION: FIREARMS SHOULD ALWAYS BE LOCKED AND STORED IN COMPLETE COMPLIANCE WITH ALL APPLICABLE LAWS AND REGULATIONS.

This cable lock is supplied as an aid to your security measures.

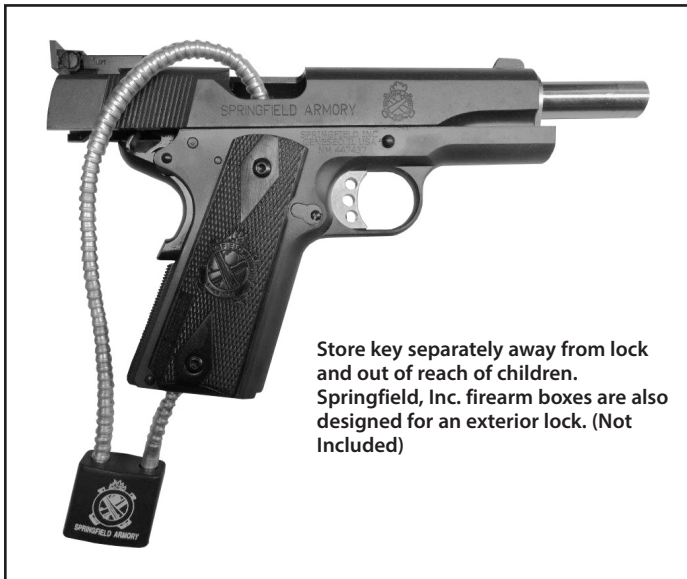

Store key separately away from lock and out of reach of children. Springfield, Inc. firearm boxes are also designed for an exterior lock. (Not Included)

Figure 58

CARE & CLEANING

Basic materials needed:

- Cleaning rod of proper size with bristle bore brushes (fiber or brass) and tip into which cleaning patch can be inserted.
- Cloth patches
- Powder solvent
- Lubricating oil
- Small lint-free cloths for wiping and oiling
- Bristle brush for scrubbing dirt off breech face, extractor, magazine lips, follower, etc.

Use proper size bore brushes and patches - if they are too small they won't do the job, and if they are too large they will bind inside bore.

When possible, insert cleaning rod from chamber end of bore and push rod all the way through so it emerges from muzzle.

Do not "reverse" rod direction when patch or brush is in barrel, it might bind.

Do not use patches dripping with solvent or oil. Wet patches or brushes, then squeeze out excess before using.

When using bore brushes or a larger bristle brush on breech face, breech areas, magazines, etc., work carefully to prevent damaging components.

***Note:** If lower parts of receiver and its mechanism are especially dirty, soak in appropriate solvent, or flush clean with same solvent. Remove grip panels before soaking or flushing, and make certain that all foreign matter is removed after cleaning. Lightly oil after cleaning.*

Only a very small amount of oil is needed to adequately lubricate moving parts and prevent rust. Stainless Steel pistols require slightly more lubrication than parkerized or blued pistols. Accumulation of oil tends to attract dust and dirt which interferes with the safe and reliable functioning of pistol. Do not apply excess lubricating oil.



Wear eye protection when using solvent. Thoroughly wash your hands to remove powder and solvents after cleaning your gun.



Always wear eye and ear protection when using any firearm. Safety and instruction manuals are available from Springfield, Inc.

CLEANING PISTOL

1. Point gun in safe direction.
2. Remove magazine and empty chamber.
3. Separate cartridges from pistol before cleaning operation.
4. Open slide and visually check that chamber and magazine well are free of cartridges.
5. Disassemble pistol as described in the proper **DISASSEMBLY** Section.
6. Using cleaning rod, run solvent-wetted patch through barrel several times.
7. Attach solvent-wetted bristle brush to rod and run back and forth full length of bore as needed until clean of grease and dirt.
8. Clean barrel with dry patches and examine it. If necessary, repeat barrel scrubbing. Bore fouling can contribute to reduced accuracy, and grease accumulation in the chamber can interfere with proper feeding of cartridges from magazine.
9. Using powder solvent on a clean patch, remove powder residue from all components of mechanism. If grease or dirt cannot be removed by wiping with patch, use solvent-wetted bristle brush.
10. Next, wipe scrubbed areas with solvent-wetted patch.
11. After cleaning, run dry patch through barrel, then follow with lightly-oiled patch.
12. Wipe all surfaces clean with cloth, then wipe all surfaces with lightly-oiled patch (or cloth).
13. Reassemble pistol. Remember, an improperly assembled firearm is dangerous and should not be fired. Always consult an experienced gunsmith if you experience any difficulty or have any questions concerning assembly procedure.
14. If pistol is to be stored for an extended period, final oil wiping can be heavier so there will be less tendency for it to evaporate. Stainless steel pistols must be lubricated.

PERIODIC CLEANING: EXTRACTOR

Note: Once the slide is removed, the firing pin removal and cleaning can be done.

Step 1 - Firing Pin Removal

1. If necessary, remove firing pin by pressing it with pin punch while simultaneously pushing firing pin tail past the firing pin stop, then pull firing pin stop downward from slide.
2. Remove firing pin and its spring.



Caution: Point the back end of the slide, where the firing pin exits, away from face to prevent injury in the event the firing pin is ejected by the spring.

Step 2 - Extractor Removal

1. Using pin punch, pull extractor by groove where firing pin stop runs.

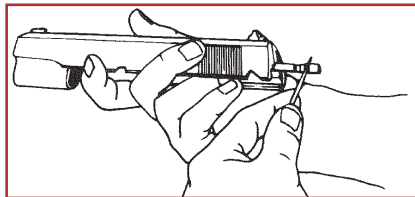

Used Guns

If you got this firearm as a used gun, **before you use it** you should make sure it is unloaded and check all its functions to be sure it works right. Guns are sometimes altered to work incorrectly, or parts may be removed, lost or replaced with incorrect parts. First, unload it and check it yourself, then take it to a good gunsmith who knows about this model of firearm, and have it checked.

DANGEROUS: .22 CONVERSION KITS FOR MODEL 1911 PISTOLS



The firing pin on some commercial .22 conversion kits protrudes back too far causing the hammer to hit the firing pin when the hammer is in the Safety Stop position. When this occurs the gun could fire and is a potentially dangerous

situation. *.22 conversion kits with this condition are dangerous and could cause serious injuries.*

For your safety and the safety of others, these .22 conversion kits should not be used on any Springfield 1911 model pistol.

SPRINGFIELD ARMORY® LIMITED WARRANTY

SPRINGFIELD ARMORY® LIMITED WARRANTY

This Limited Warranty is issued by Springfield, Inc., d/b/a Springfield Armory, an Illinois corporation (“Springfield” or “we” or “us” or “our”) to “You” the original retail purchaser (also “YOUR”) of a Springfield product (the “Product”). This Limited Warranty gives You specific legal rights, and You may also have other rights which vary from state to state.

WHO AND WHAT IS COVERED BY THIS WARRANTY?

Springfield, Inc. warrants to You, the original retail purchaser of the Product, that the Product You purchased will be free of defects in workmanship or material, subject to the terms of this document.

HOW LONG WILL THIS WARRANTY LAST?

This Warranty will be in effect during the time that YOU, the original retail purchaser, own the product. Proof of original purchase required.

WHAT DO YOU HAVE TO DO FOR WARRANTY SERVICE?

You must take 3 steps to get warranty service. Notify us by phone, email, fax, or mail. If You discover a defect in material or workmanship, You must notify us by telephone, email, fax or mail at once of the Warranty Service Contact Points. Warranty Service Contact Points:

Telephone: 800-680-6866

Email: warranty@springfieldwarranty.com

Fax: 309-944-3676

Mail: Springfield Armory
420 West Main Street
Geneseo, Illinois 61254
Attn: Warranty Service

Write a brief description of the defect. Please write down a brief description of the defect and how YOU experienced or discovered the defect. Follow the return instructions you receive from Springfield. Once we receive Your notification for warranty notice at one of our Warranty Service Contact Points, we will provide You with a shipping coupon (so that we can pay for the shipping) and instructions on how to return Your Product for service. You must follow the shipping instructions once You receive them.

WHAT WILL SPRINGFIELD DO IF YOU DISCOVER A DEFECT?

If, during YOUR ownership of the Product, one or more parts of the Product fail due to defects in materials or workmanship, Springfield will provide, free of charge, a new, repaired or reconditioned (decided at our discretion) Product. That new, repaired or reconditioned Product will be warranted for the remainder of YOUR ownership of the Product under these terms and conditions.

WHAT IS NOT COVERED BY THIS LIMITED WARRANTY?

This Limited Warranty does not cover any damage or condition determined by Springfield to be caused by: unauthorized repairs, disassembly, adjustments or modifications, carelessness, negligence, misuse, or unsafe handling, normal wear and tear, failure to properly or reasonably store, use, or maintain the product, hand-loaded, reloaded, re-manufactured, or defective ammunition.



The HELLCAT®, like all firearms, is a dangerous weapon if not handled properly.

LIMITATION OF LIABILITY AND DISCLAIMERS

This limited warranty is provided in lieu of any and all express warranties. All implied warranties, including implied warranties of merchantability, non-infringement and fitness for a particular purpose, are limited in duration to the duration of the warranty period (the original purchaser's (your) ownership of the product) and no warranties, hether express or implied, will apply after such period.

Some states do not allow limitations on the duration of an implied warranty, so the above limitation may not apply to you. Springfield's responsibility for malfunctions and defects in the product is limited to the terms set forth in this limited warranty. The preceding limited warranty constitutes springfield's only obligation to you and represents your exclusive remedy against springfield. In no event will springfield be liable for incidental, special or consequential damages, regardless of whether your claims are based on breach of contract, tort (including negligence and strict liability) or other theories, including, without limitation, any liability for economic loss, bodily injury, property damage or for any damage that may result from your use or ownership of the product, whether foreseeable or not. Some states do not allow the exclusion or limitation of incidental or consequential damages or certain other exclusions contained in warranties, so the above limitations or exclusions may not apply to you. The limitations set forth in this limited warranty shall not apply to the extent that they are prohibited by law.

No person or entity is authorized to give any other warranty or to assume any other obligation on behalf of Springfield. Any provision of this Limited Warranty prohibited or unenforceable in any jurisdiction shall be ineffective only to the extent of such prohibition and shall not invalidate any of the remaining provisions of this Limited Warranty.

GOVERNING LAW/VENUE/CONSENT TO JURISDICTION

This Limited Warranty will be governed and construed in accordance with the law of the State of Illinois, without regard to Illinois' conflict of law rules. Any litigation between SPRINGFIELD and YOU or YOUR heirs, representatives or assigns shall be filed before a court of competent jurisdiction and venue in the 14th Judicial District of the State of Illinois. YOU HEREBY CONSENT TO THE IN PERSONAM JURISDICTION AND VENUE OF THE ILLINOIS COURTS, AND THAT SERVICE OF THE PROCESS MAY BE MADE UPON YOU AS PROVIDED BY ILLINOIS LAW.

KEEP THIS CARD FOR YOUR RECORDS

Serial Number _____

Date Of Purchase _____

Place Of Purchase _____



ACTIVATE YOUR WARRANTY ONLINE AT:

www.springfieldwarranty.com/StartWarranty.asp

And receive a coupon for specific discounted items on our webstore.
Magazines, shirts, hats, range bags and much more.

SPRINGFIELD ARMORY®

420 WEST MAIN STREET, GENESEO, IL 61254 • 800-680-6866



Safety and instruction manuals are available from
Springfield, Inc.



Always wear eye and ear protection when using any firearm.

DOWNLOAD THIS MANUAL ON OUR WEBSITE: WWW.SPRINGFIELD-ARMORY.COM

Always check website for updated versions of operation & safety manuals

Revised 8/7/20

Copyright 2020. Contents property of Springfield, Inc. All rights reserved.