



2022 MOUNTS • RINGS • BASES • PRECISION SHOOTING ACCESSORIES





CONTENTS

MOUNTAIN TECH™ RINGS	4
* MOUNTAIN TECH™ RAILS	6
MAXIMA® BASES	8
MAXIMA® HORIZONTAL™ RINGS	10
MAXIMA® VERTICAL RINGS	11
MAXIMA® TIKKA RINGS	12
MAXIMA® CZ RINGS	12
MAXIMA® RUGER RINGS	12
MAXIMA® RIMFIRE RINGS	14
* VAPOR® RINGS, BASES & 1 PIECE MOUNTS	15
SKYLINE™ PRECISION MOUNT	16
SKYLINE™ PRECISION MOUNT ACCESSORIES	16
SKYLINE™ PRECISION BIPOD	18
SKYLINE™ PRECISION BIPOD ACCESSORIES	18
MSR 1 PIECE MOUNTS	20
* TACTICAL RED DOT RISER	22
TACTICAL A645 SIDE MOUNT	22
TACTICAL RED DOT MOUNTS	23
* TACTICAL MAGAZINE EXTENSIONS	24
TOOLS	25
WARNE® SWAG	26
TEAM WARNE® PRO STAFF	27

* NEW FOR 2022

WHO IS WARNE:

SHOOTERS AT HEART - We are shooters who create, design, sell and use our products. We enjoy the outdoors and all aspects of the shooting sports. We are proudly based out of the Pacific Northwest in Tualatin, Oregon. Our products are made here in the USA and we are completely hands on during the whole manufacturing process. The Warne® brand has been and always will be “built by shooters, for shooters”.



Lifetime Warranty

All Warne Scope Mounts carry our quality guarantee against damage or defects in workmanship for the life of the product.

No Receipt, No Warranty Card, No Package – No Problem.

We will repair or replace (at our discretion) your Warne product in the event it becomes damaged or defective during normal use at no charge to you.

High quality scope mounts & exceptional customer service are our top priorities.

We want you to be satisfied and confident that we stand behind our products round after round.



ICON LEGEND

Look for these icons throughout the catalog to find which of these benefits and features fit your needs.



7075 billet aluminum has the high, strength-to-weight ratio, required for ultra-strong and lightweight mounts. Used in the aerospace industry, 7075 exceeds military specifications.



Hardcoat anodize prevents wear during extreme use.



Epoxy powder coat finish that creates a durable weather-proof and long-lasting finish.



Designed to offer a good strength to weight ratio, attractive finish and high value to shooters.



Durable and reliable for the hunt of a lifetime.



Quickly switch between scope and iron sights, swap scopes or remove scope for easier transport and storage. Toolless design for installation and removal.



Adds protection and keeps the product looking new for greater long term value.



Large capacity allows for maximum round count while maintaining USPSA maximum magazine length limit.



Confidently remove and re-mount your scope while maintaining the same point of impact.



Allows the most ergonomic shooting position for MSR's with an optic.



Strength and dependability for law enforcement and military use.



Modern preformed fit that keeps its shape.



Reduces abrasion and wear while giving a unique color finish to individualize your firearm.



Designed specifically to excel at long range precision and extreme distance shooting.



Reinforces thread engagement, eliminating stripped screws.



Highest quality materials - finishes and features that competition shooters demand.



Engineered to be 30-60% lighter than similar mounts.



Superior strength and clamping characteristics specifically formulated for scope mounts.



Better strength and toughness than carbon steel, ideal for hand tools.



Mid capacity allows for additional round count in an easy to carry size.



Made of steel for the strongest foundation available.



Designed with no top button allowing a more comfortable fit when wearing over the head hearing protection.



M-Lok® picatinny rail interface to fit various hand guards for mounting accessories.
M-Lok is a registered trademark of Magpul.



Engineered to provide world class performance at the range or in the field.



Designed to withstand anything Mother Nature dishes out.



Moisture wicking Sport-Tek® 3.8oz polyester fabric.



Torque wrench allows for aspecific and consistent tightening of various fasteners.



Lightweight and roomy design.



NATO tests show that this attachment method increases repeatable alignment. These mounts are Weaver style and Mil-Spec 1913 compatible.



Zero additional capacity adds additional strength and cosmetic appeal.



WHY WE DESIGNED THESE:

LIGHTWEIGHT & ELEMENT PROOF - We engineered Warne® Mountain Tech™ as a lightweight and rugged scope ring design that is equally at home on a mountain rifle or precision target rifle. Featuring 7075 aluminum construction and stainless hardware to withstand the punishing conditions Mother Nature can dish out. (DESIGN PATENT D802703)

KEY FEATURES:

AB 7075 Billet	AR MSR Ideal Height	Ns NATO/STANAG	Hc Hardcoat Anodized Finish	RtZ Return to Zero	H2O Element Proof	LW Lightweight	Ck Cerakote Finish	Hu Hunting	Ts Target Shooting	LEM LE/Military
--------------------------	-------------------------------	--------------------------	---------------------------------------	------------------------------	-----------------------------	--------------------------	------------------------------	----------------------	------------------------------	---------------------------

BEST USES:

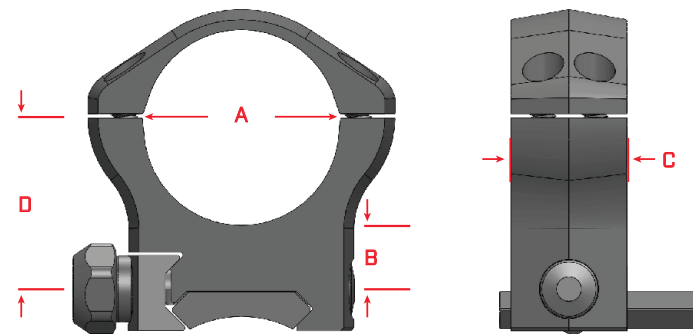

PART NUMBER	RING HEIGHT	FITS OBJECTIVE SIZE* [General Ranges]	DIMENSION A	DIMENSION B	DIMENSION C	DIMENSION D	WEIGHT [Per Pair]	RING STYLE
7200M	Low	20-36mm objective	1 inch	.275"	.705"	--	2.9 oz	FIXED
7201 (M or BB)	Medium	36-42mm objective	1 inch	.400"	.705"	--	3.9 oz	FIXED
7202M	High	42-52mm objective	1 inch	.550"	.705"	--	4.2 oz	FIXED
7204M	Ultra High	MSR Ideal Height	1 inch	--	.705"	1.4"	5.1 oz	FIXED
7213 (M or BB)	Low	24-42mm objective	30mm	.275"	.705"	--	3.5 oz	FIXED
7214 (M or BB)	Medium	42-52mm objective	30mm	.400"	.705"	--	3.9 oz	FIXED
7215M	High	50-56mm objective	30mm	.550"	.705"	--	4.5 oz	FIXED
7217M	Ultra High	MSR Ideal Height	30mm	--	.705"	1.4"	5.1 oz	FIXED
7220M	Low	30-42mm objective	34mm	.275"	.705"	--	3.9 oz	FIXED
7221M	Medium	42-52mm objective	34mm	.400"	.705"	--	4.2 oz	FIXED
7222M	High	52+mm objective	34mm	.550"	.705"	--	4.5 oz	FIXED
7224M	Ultra High	MSR Ideal Height	34mm	--	.705"	1.4"	5.1 oz	FIXED
7240M	Low	30-42mm objective	35mm	.275"	.705"	--	3.9 oz	FIXED
7241M	Medium	42-52mm objective	35mm	.400"	.705"	--	4.2 oz	FIXED
7242M	High	52+mm objective	35mm	.550"	.705"	--	4.5 oz	FIXED
7244M	Ultra High	MSR Ideal Height	35mm	--	.705"	1.4"	5.1 oz	FIXED
7250M	Low	Up to 52mm objective	40mm	.325"	.705"	1.24"	4.3 oz	FIXED

* All sizes listed are approximate, every firearm and scope set up varies.

FINISH COLOR LEGEND:

Finish color is determined by the specific letter at the END of the part number. All part numbers are available in matte finish (M) and part numbers available in cerakote burnt bronze will have a (BB) notated above. Final part number example: 7201M is matte black and 7201BB is burnt bronze finish.





WHY WE DESIGNED THESE:

VERSATILITY & STABILITY - Warne® Mountain Tech™ rails offer shooters the advantage of a consistent mounting platform across multiple firearms, enhanced ability to adjust proper eye relief and superior alignment of ring mounts. With self-centering hardware and aerospace grade materials, our Mountain Tech™ rails provide a lightweight and robust platform for your rifle.



KEY FEATURES:

AB 7075 Billet	Ns NATO/ STANAG	Hc Hardcoat Anodized Finish	H₂O Element Proof	LW Lightweight	Ck Cerakote Finish
--------------------------	------------------------------	--	---	--------------------------	---------------------------------

BEST USES:

Hu Hunting	Ts Target Shooting	LEM LE/Military
----------------------	---------------------------------	---------------------------



FIREARM MANUFACTURER & MODEL

1 PIECE RAIL WITH ZERO MDA		1 PIECE RAIL WITH 20 MDA	
SHORT ACTION	LONG ACTION	SHORT ACTION	LONG ACTION

NEW for 2022

Bergara Premier Series (Rem 700 style, 8-40 Screws)	7671M	7672M	7671-20MOA	7672-20MOA
Browning X-Bolt	7641M	7642M	7641-20MOA	7642-20MOA
	7641BB	7642BB	7641BB-20MOA	7642BB-20MOA
Browning X-Bolt Super Short Action	7640M	--	7640-20MOA	--
CZ 452/455	--	--	7755M [†]	7755M [†]
CZ 457	--	--	7757M [†]	7757M [†]
HS Precision (8-40 Screws)	7671M	7672M	7671-20MOA	7672-20MOA
Howa 1500 & 1700	7650M	7651M	7650-20MOA	7651-20MOA
Howa Mini Action	7656M	7656M	7656-20MOA	7656-20MOA
Kimber 84M	7657M	7657M	7657-20MOA	7657-20MOA
Kimber 84L	7658M	7658M	7658-20MOA	7658-20MOA
Kimber 8400 WSM	7659M	7659M	7659-20MOA	7659-20MOA
Kimber 8400 Magnum	7660M	7660M	7660-20MOA	7660-20MOA
Nosler M48	7682M	7683M	7682-20MOA	7683-20MOA
Remington Police & XCR .338 LM (8-40 Screws)	7671M	7672M	7671-20MOA	7672-20MOA
Remington 700	7673M	7674M	7673-20MOA	7674-20MOA
	7673BB	7674BB	7673BB-20MOA	7674BB-20MOA
Ruger American Centerfire	7684M	7685M	7684-20MOA	7685-20MOA
Savage Accu-Trigger, Round Receiver, All Center Fire[§]	7666M	7667M	7666-20MOA	7667-20MOA
Accu-Trigger (with 8-40 Screws)	7664M	7665M	7664-20MOA	7665-20MOA
Savage 220F Slug Gun	--	7667M	--	7667-20MOA
Savage AXIS & Edge	7699M	7699M	7699-20MOA	7699-220MOA
Savage AXIS/AXIS II 2021 & Newer models (8-40 Screws)	7698M	7698M	7698-20MOA	7698-20MOA
Tikka T3, T3X	76T3M	76T3M	76T3-20MOA	76T3-20MOA
Weatherby Mark V Magnum 9 Lug, Except .240 WM	7654M	7654M	7654-20MOA	7654-20MOA
Weatherby Mark V Standard 6 Lug	7653M	7653M	7653-20MOA	7653-20MOA
Weatherby Vanguard	7650M	7651M	7650-20MOA	7651-20MOA
Winchester Model 70 Standard Pre & Post 64 with .860 RHS*	7675M	7676M	7675-20MOA	7676-20MOA
Winchester Model 70 WSM	7677M	--	7677-20MOA	--
Winchester XPR	7688M	7688M	7688-20MOA	7688-20MOA

NEW for 2022

TACTICAL STEEL RAILS

Marlin 336, 375 & 1895	--	--	M636-20MOA	M636-20MOA
Remington 700	M673M	M674M	M673-20MOA	M674-20MOA
Ruger Mini 14 Ranch Rifle, 30, 77/22, 77/44, PC9 & PC40	A971M	A971M	--	--
Savage B-Mag	A631M	--	--	--
Tikka T3, T3X	M6T3M	M6T3M	M6T3-20MOA	M6T3-20MOA
Weatherby Mark V Magnum 9 Lug, Except .240 WM	M654M	M654M	M654-20MOA	M654-20MOA

[†] 15MOA Picatinny Rail Adapter

[§] Will not fit the Savage Model 25.

* RHS=Rear Hole Spacing: The measurement between the two rear screw holes, center to center.

FINISH COLORS: All part numbers are matte black unless notated with a "BB" for cerakote burnt bronze.

MAXIMA[®]

SCOPE BASES



WHY WE DESIGNED THESE:

STRENGTH & VERSATILITY - Warne[®] Maxima[®] steel bases are the strongest and most versatile mounting system available today. The simple low profile design along with steel construction is a significant upgrade from any other 2 piece bases.

MANUFACTURER & MODEL	2 PIECE STEEL BASE SET	MANUFACTURER & MODEL	2 PIECE STEEL BASE SET
Anschutz (All) Marlin A1 & 50 Gloss	M824/824M	Ruger 10/22	M858/918M
Browning A-Bolt, 22 Micro-Medallion, WSM	M918/918M	Ruger American	M902/902M
Browning A-Bolt Slug Gun	M904/922M	Sako A-7	M918/918M
Browning A-Bolt 3	M912/912M	Savage Pre 2003 Bolt Action, Flat Receiver, Non Accu-Trigger	M902/936M
Browning BAR, BAR II, Mark II, BLR Lightweight, BPR Pump	M848/848M	Savage Accu-Trigger, Round Receiver, All Center Fire [§]	M902/902M
Browning BLR (Steel Receiver)	M838/838M	Savage 10, 110 BA, FCP (Savage Round Receiver with 8-40 Screws)	M912/912M
Browning X-Bolt	M927/929M (BB)	Savage Mark II, 93R17	M824/824M
Cooper 21, 36, 38 & 57	M888/842M	Savage 22DF Slug Gun	M902/902M
Cooper 16, 22, 50, 52, 54 & 56	M898/848M (S)	Savage Axis/Edge	M902/902M
CVA-V2 Series Round Barrel	M980/980M	Tikka All Flat Tops	M932/932M
Howa 1500 & 1700	M902/876M (BB)	Tikka T3	M9T3M <i>*see below</i>
JC Higgins Model 50	M902/831M	Thompson Center Encore, Omega & Triumph Bone Collector	M987M <i>*see below</i>
Kimber 8400 with 8-40 screws	M887/841M	Thompson Center Contender	M988M <i>*see below</i>
Kimber M84 & New 22 with 8-40 screws	M889/843M	Thompson Center Venture	M902/902M
Marlin 9, 45, 30AS, 36, 62, 93, 336, 336C, 375 61895	M864/864M	Weatherby Mark V Standard 6 Lug & .240 WM	M888/875M
Marlin 1894 Cowboy, 444, Glenfield 30, Zane Grey	M864/864M	Weatherby Mark V Magnum 9 Lug, Except .240 WM	M902/879M
Marlin XL-7	M902/924M	Weatherby Vanguard	M902/876M (BB)
Mauser 98 Altered	M902/830M	Winchester Model 70 Std. Pre & Post 64 with .860 RHS	M902/924M
Mauser 98 Unaltered	M902/832M	Winchester Model 70 WSM	M902/924M
Nosler M48	M902/876M (BB)	Winchester Model 70 Post 64 Magnum with .330 RHS	M902/802M
Remington 700	M902/876M (BB)	Winchester Model 70 Pre 64 Magnum with .440 RHS	M902/818M
Remington 7400, 7600, 7615, FOUR, SIX & New 750	M894/870M	Winchester Model 70 WSSM	M902/903M
Remington 783	M902/902M	Winchester XPR	M916/954M
Remington New Model 7, 600, 660, 670, 673, XP-100 & XR-100	M902/801M		

* The M9T3M, M987M & M988M part numbers are a 1 piece Weaver style bases not a 2 piece base set.

§ Will not fit the Savage Model 25.

RHS= Rear Hole Spacing: The measurement between the two rear screw holes, center to center.

FINISH COLOR LEGEND:

Finish color is determined by the specific letter at the END of the part number. All part numbers are available in matte finish (M) and part numbers available in burnt bronze will have a (BB) notated above. (M) is blued finish and (BB) is cerakote finish.

Final part number example: M902/876M is matte black finish and M902/876BB is burnt bronze finish.

KEY FEATURES:



BEST USES:

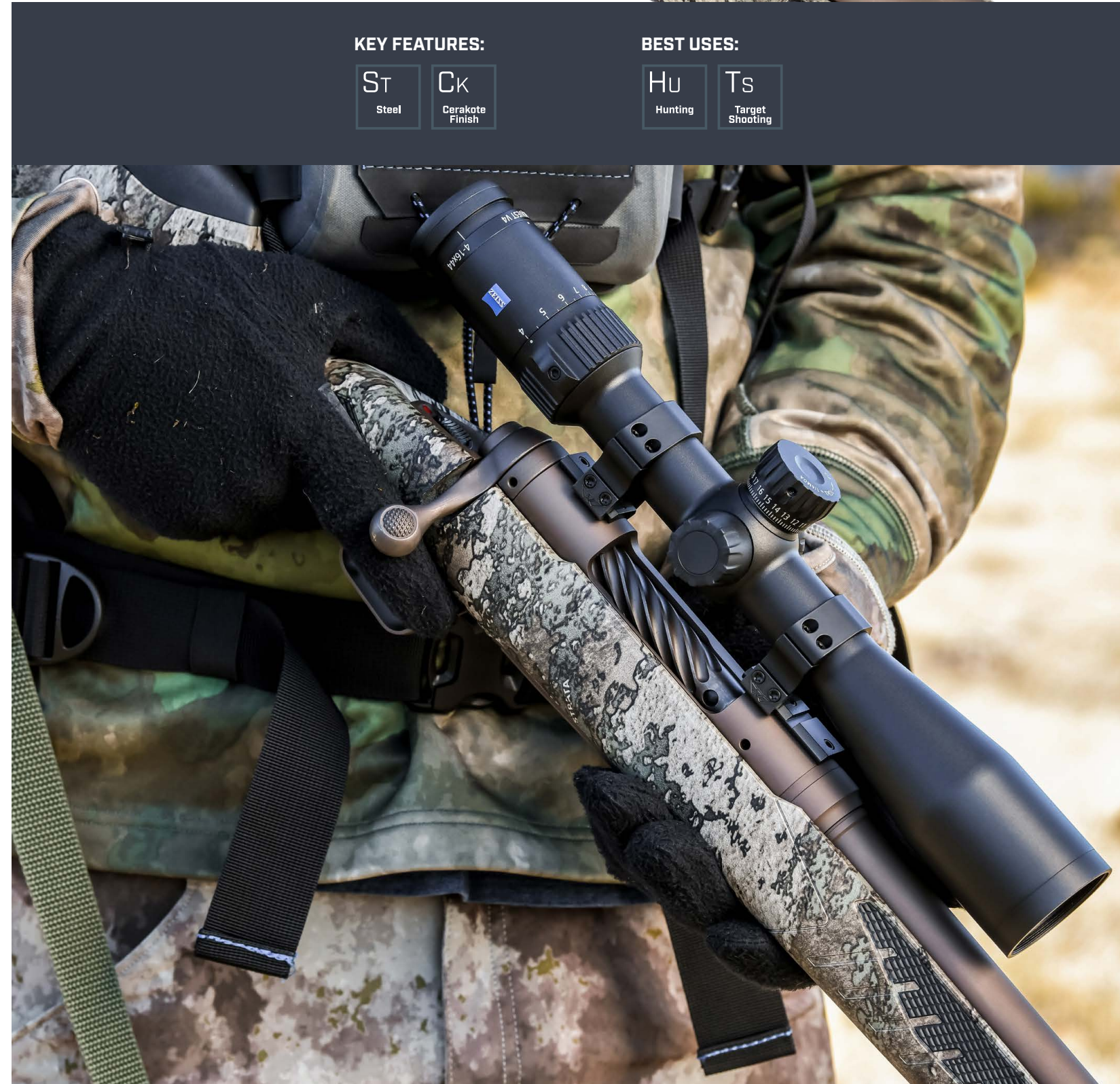

MAXIMA[®] HORIZONTAL™

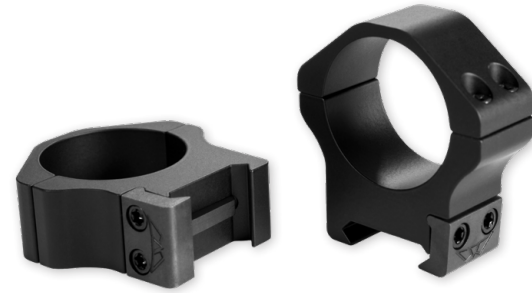

WHY WE DESIGNED THESE:

THE NEW STANDARD - Warne[®] Maxima[®] Horizontal™ Rings evolved from the concept of incorporating the world renowned performance, materials and reputation of Maxima rings in a more traditional, horizontally split configuration. Maxima Horizontal rings include several design features that enhance performance, ease installation and include the return to zero guarantee that Warne is known for.

KEY FEATURES:



BEST USES:

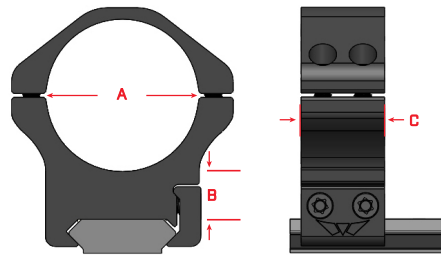

PART NUMBER	RING HEIGHT	FITS OBJECTIVE SIZE* (General Ranges)	DIMENSION A	DIMENSION B	DIMENSION C	WEIGHT	RING STYLE
500M	Low	20-36mm objective	1 inch	.250"	.650"	4.9 oz	FIXED
501M	Medium	36-42mm objective	1 inch	.375"	.650"	5.8 oz	FIXED
502M	High	42-52mm objective	1 inch	.525"	.650"	6.8 oz	FIXED
513M	Low	24-42mm objective	30mm	.250"	.650"	5.0 oz	FIXED
514M	Medium	42-52mm objective	30mm	.375"	.650"	6.0 oz	FIXED
515M	High	50-56mm objective	30mm	.525"	.650"	6.9 oz	FIXED

MAXIMA[®] VERTICAL



WHY WE DESIGNED THESE:

INCREDIBLE HOLDING POWER & ELEGANT PROFILE - Warne[®] Maxima[®] Rings have proven to be the strongest scope rings on the market. The vertically split design offers robust simplicity and ease of installation. American made quality and precision at an affordable price make Warne[®] Maxima[®] scope rings the best in their class.



KEY FEATURES:



BEST USES:



PART NUMBER	RING HEIGHT	FITS OBJECTIVE SIZE* (General Ranges)	DIMENSION A	DIMENSION B	DIMENSION C	WEIGHT	RING STYLE
200M	Low	20-36mm objective	1 inch	.250"	.705"	4.3 oz	FIXED
201M	Medium	36-42mm objective	1 inch	.375"	.705"	5.2 oz	FIXED
202M	High	42-52mm objective	1 inch	.525"	.705"	6.2 oz	FIXED
203M	Extra High	50-56mm objective	1 inch	.650"	.705"	6.8 oz	FIXED
213M	Low	24-42mm objective	30mm	.250"	.705"	4.6 oz	FIXED
214M	Medium	42-52mm objective	30mm	.375"	.705"	5.3 oz	FIXED
215M	High	50-56mm objective	30mm	.525"	.705"	6.2 oz	FIXED
216M	Extra High	Up to 62mm OD	30mm	.650"	.705"	7.1 oz	FIXED
220M	Low	30-42mm objective	34mm	.250"	.705"	4.7 oz	FIXED
221M	Medium	42-52mm objective	34mm	.375"	.705"	5.5 oz	FIXED
222M	High	52+mm objective	34mm	.525"	.705"	6.4 oz	FIXED
231M	Medium	36-65mm objective	36mm	.375"	.705"	5.9 oz	FIXED
200LM	Low	20-36mm objective	1 inch	.250"	.705"	4.9 oz	QUICK DETACH
201LM	Medium	36-42mm objective	1 inch	.375"	.705"	5.8 oz	QUICK DETACH
202LM	High	42-52mm objective	1 inch	.525"	.705"	6.8 oz	QUICK DETACH
203LM	Extra High	50-56mm objective	1 inch	.650"	.705"	7.4 oz	QUICK DETACH
204LM	Ultra High	MSR Ideal Height	1 inch	.935"	.705"	9.3 oz	QUICK DETACH
213LM	Low	24-42mm objective	30mm	.250"	.705"	5.2 oz	QUICK DETACH
214LM	Medium	42-52mm objective	30mm	.375"	.705"	5.9 oz	QUICK DETACH
215LM	High	50-56mm objective	30mm	.525"	.705"	6.9 oz	QUICK DETACH
216LM	Extra High	Up to 62mm OD	30mm	.650"	.705"	7.7 oz	QUICK DETACH
217LM	Ultra High	MSR Ideal Height	30mm	.850"	.705"	9.7 oz	QUICK DETACH
220LM	Low	30-42mm objective	34mm	.250"	.705"	5.3 oz	QUICK DETACH
221LM	Medium	42-52mm objective	34mm	.375"	.705"	6.0 oz	QUICK DETACH
222LM	High	52+mm objective	34mm	.525"	.705"	7.1 oz	QUICK DETACH
231LM	Medium	36-65mm objective	36mm	.375"	.705"	6.4 oz	QUICK DETACH

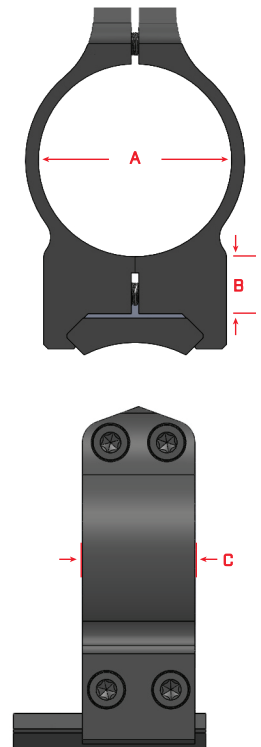

* All sizes listed are approximate, every firearm and scope set up varies.

MAXIMA®

TIKKA—CZ—RUGER

Warne's Maxima® grooved receiver rings are solid steel, vertically split rings that handle even the most punishing recoil, or large, heavy scopes.



WHY WE DESIGNED TIKKA RINGS:

SIMPLICITY! - Tikka rifles have a grooved receiver that allows for a dovetail ring to mount directly to it, negating the need for a base.

Tikka Rail and base options:

76T3M - Aluminum rail for Tikka T3, T3X models (page 6)
76T3-20MOA - 20MOA aluminum rail for Tikka T3, T3X models (page 6)

M6T3M - Steel rail for Tikka T3, T3X models (page 24)

M6T3-20MOA - 20MOA steel rail for Tikka T3, T3X models (page 24)

M9T3M - Steel Weaver style 1 piece base for Tikka T3 models (page 9)

M932/932M - Steel Weaver style 2 piece bases for all flat top Tikka models (page 9)



CZ 550



CZ 527

WHY WE DESIGNED CZ RINGS:

DIRECT FIT UPGRADE - Designed to fit the 19mm 550/557 and the 16mm 527 integral dovetails.

11mm Picatinny Rail Adapter Options: (page 6)

7755M - 15MOA rail for CZ 452/455 models

7757M - 15MOA rail for CZ 457 models



WHY WE DESIGNED RUGER RINGS:

MODEL SPECIFIC FIT - Sold in pairs, Maxima® Ruger rings are packaged in model specific configurations to fit Ruger's proprietary dovetails.

KEY FEATURES:

Ss
Sintered Steel

RtZ
Return to Zero

Ns
NATO/
STANAG

BEST USES:

Hu
Hunting

Ts
Target Shooting

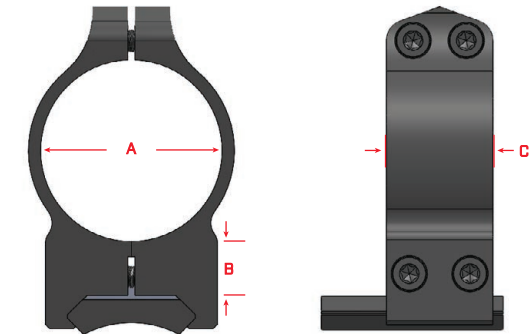

	PART NUMBER	RING HEIGHT	FITS OBJECTIVE SIZE* [General Ranges]	DIMENSION A	DIMENSION B	DIMENSION C	WEIGHT [Per Pair]	RING STYLE
Fits only TIKKA MODELS	1TM	Medium	20-42mm objective	1 inch	.460"	.705"	5.6 oz	FIXED
	2TM	High	42-52mm objective	1 inch	.570"	.705"	6.3 oz	FIXED
	14TM	Medium	24-52mm objective	30mm	.460"	.705"	5.7 oz	FIXED
	15TM	High	50-56mm objective	30mm	.570"	.705"	6.4 oz	FIXED
	1TLM	Medium	20-42mm objective	1 inch	.460"	.705"	6.0 oz	QUICK DETACH
2TLM	High	42-52mm objective	1 inch	.570"	.705"	6.8 oz	QUICK DETACH	
14TLM	Medium	24-52mm objective	30mm	.460"	.705"	6.1 oz	QUICK DETACH	
15TLM	High	50-56mm objective	30mm	.570"	.705"	6.8 oz	QUICK DETACH	
Fits only CZ 527 MODELS	1B1M	Medium	20-42mm objective	1 inch	.425"	.705"	5.3 oz	FIXED
	2B1M	High	42-52mm objective	1 inch	.535"	.705"	6.0 oz	FIXED
	14B1M	Medium	24-52mm objective	30mm	.425"	.705"	5.4 oz	FIXED
	15B1M	High	50-56mm objective	30mm	.535"	.705"	6.1 oz	FIXED
	1B1LM	Medium	20-42mm objective	1 inch	.425"	.705"	5.8 oz	QUICK DETACH
2B1LM	High	42-52mm objective	1 inch	.535"	.705"	6.5 oz	QUICK DETACH	
14B1LM	Medium	24-52mm objective	30mm	.425"	.705"	5.9 oz	QUICK DETACH	
15B1LM	High	50-56mm objective	30mm	.535"	.705"	6.6 oz	QUICK DETACH	
Fits only CZ 550 MODELS	1BM	Medium	20-42mm objective	1 inch	.425"	.705"	5.4 oz	FIXED
	2BM	High	42-52mm objective	1 inch	.535"	.705"	6.1 oz	FIXED
	14BM	Medium	24-52mm objective	30mm	.425"	.705"	5.4 oz	FIXED
	15BM	High	50-56mm objective	30mm	.535"	.705"	6.3 oz	FIXED
	1BLM	Medium	20-42mm objective	1 inch	.425"	.705"	5.9 oz	QUICK DETACH
2BLM	High	42-52mm objective	1 inch	.535"	.705"	6.7 oz	QUICK DETACH	
14BLM	Medium	24-52mm objective	30mm	.425"	.705"	6.1 oz	QUICK DETACH	
15BLM	High	50-56mm objective	30mm	.535"	.705"	6.9 oz	QUICK DETACH	
Fits only RUGER No. 1 & MINI 14 MODELS	1RM	Medium	20-42mm objective	1 inch	.460"	.705"	5.6 oz	FIXED
	2RM	High	42-52mm objective	1 inch	.585"	.705"	6.5 oz	FIXED
	14RM	Medium	24-52mm objective	30mm	.460"	.705"	5.7 oz	FIXED
	15RM	High	50-56mm objective	30mm	.585"	.705"	6.5 oz	FIXED
	1RLM	Medium	20-42mm objective	1 inch	.460"	.705"	6.0 oz	QUICK DETACH
2RLM	High	42-52mm objective	1 inch	.585"	.705"	6.9 oz	QUICK DETACH	
14RLM	Medium	24-52mm objective	30mm	.460"	.705"	6.1 oz	QUICK DETACH	
15RLM	High	50-56mm objective	30mm	.585"	.705"	6.8 oz	QUICK DETACH	
Fits only RUGER M77 & HAWKEYE MODELS	1R7M	Medium	20-42mm objective	1 inch	.460"	.705"	6.0 oz	FIXED
	2R7M	High	42-52mm objective	1 inch	.585"	.705"	6.9 oz	FIXED
	14R7M	Medium	24-52mm objective	30mm	.460"	.705"	6.1 oz	FIXED
	15R7M	High	50-56mm objective	30mm	.585"	.705"	6.9 oz	FIXED
	1R7LM	Medium	20-42mm objective	1 inch	.460"	.705"	6.4 oz	QUICK DETACH
2R7LM	High	42-52mm objective	1 inch	.585"	.705"	7.2 oz	QUICK DETACH	
14R7LM	Medium	24-52mm objective	30mm	.460"	.705"	6.6 oz	QUICK DETACH	
15R7LM	High	50-56mm objective	30mm	.585"	.705"	7.3 oz	QUICK DETACH	

* All sizes listed are approximate, every firearm and scope set up varies.



MAXIMA[®]

RIMFIRE



WHY WE DESIGNED THESE:

OVER BUILT FOR THE TASK - The Warne[®] Rimfire rings were created to fit both the 3/8th inch and 11mm dovetails found on many common rimfire rifles. Featuring a unique 70/30 horizontal split design, these steel rimfire rings are the best available.

Warne Tip: When installing either style Rimfire rings, be sure to notice which direction the small dot on the side clamp is facing. If it is in the 'up' position the rings will fit a 3/8" dovetail and if the dot is facing 'down' it will fit an 11mm dovetail.

KEY FEATURES:



BEST USES:

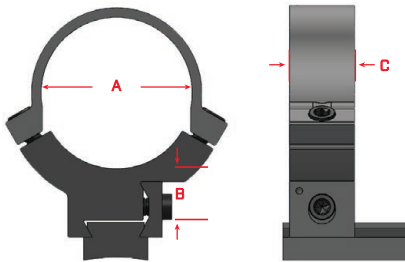

PART NUMBER	RING HEIGHT	FITS OBJECTIVE SIZE* (General Ranges)	DIMENSION A	DIMENSION B†	DIMENSION C	WEIGHT (Per Pair)	RING STYLE
721M	Medium	20-42mm objective	1 inch	.400"	.502"	3.2 oz	FIXED
722M	High	42-52mm objective	1 inch	.525"	.502"	3.6 oz	FIXED
721LM	Medium	20-42mm objective	1 inch	.400"	.502"	3.8 oz	QUICK DETACH
722LM	High	42-52mm objective	1 inch	.525"	.502"	4.3 oz	QUICK DETACH
731M	Medium	20-42mm objective	30mm	.400"	.502"	3.6 oz	FIXED
732M	High	42-52mm objective	30mm	.525"	.502"	4.1 oz	FIXED

VAPOR[®]

WHY WE DESIGNED THESE:

AFFORDABLE, MADE IN USA QUALITY - Our Vapor[®] line of mounts were developed and engineered to provide you with a strong and economical mounting solution that outperforms other mounts in their class.



KEY FEATURES:



BEST USES:



2 PIECE BASES



MANUFACTURER & MODEL	PART NUMBER	MANUFACTURER & MODEL	PART NUMBER
Browning X-Bolt	V427/429M	Ruger American Rimfire	V425/425M
Browning A-Bolt 3 with 8-40 screws	V412/412M	Ruger American Centerfire	V402/402M
Christensen Arms All Mesa, Ridgeline	V402/476M	Savage 10/110 with 8-40 screws	V412/412M
Howa 1500	V402/476M	Savage 10/110 with 6-48 screws	V402/402M
Marlin Lever Action 336, 1894, 1895	V464/464M	Weatherby Vanguard	V402/476M
Remington 700	V402/476M	Winchester Model 70 with .860 RHS	V402/424M

RHS= Rear Hole Spacing: The measurement between the two rear screw holes, center to center.

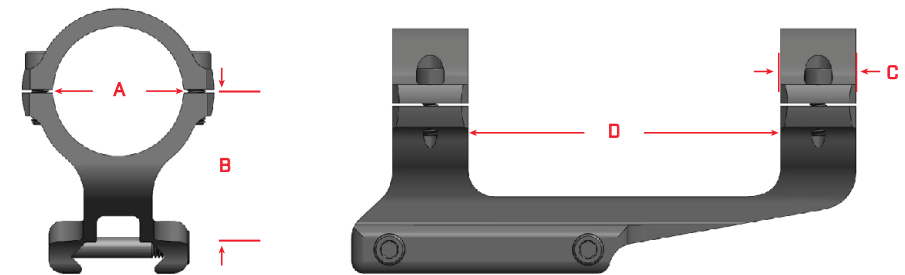

RINGS & MSR MOUNTS

PART NUMBER	RING HEIGHT	FITS OBJECTIVE SIZE* (General Ranges)	DIMENSION A	DIMENSION B†	DIMENSION C	DIMENSION D	WEIGHT	RING STYLE
V400M	Low	20-36mm objective	1 inch	.225"	.600"		1.6 oz	2 PIECE
V401M	Medium	36-42mm objective	1 inch	.350"	.600"		1.9 oz	WEAVER
V402M	High	42-52mm objective	1 inch	.550"	.600"		2.2 oz	WEAVER
V413M	Low	24-42mm objective	30mm	.225"	.600"		1.8 oz	2 PIECE
V414M	Medium	42-52mm objective	30mm	.350"	.600"		2.0 oz	WEAVER
V415M	High	50-56mm objective	30mm	.550"	.600"		2.3 oz	WEAVER
V420M	Low		1 inch					2 PIECE
V421M	Medium		1 inch					RIMFIRE
V422M	High		1 inch					RIMFIRE
V4001M	Ultra High	MSR Ideal Height	1 inch	1.40"	.750"		4.7 oz	1 PIECE
V4011M [20MDA]	Ultra High	MSR Ideal Height	1 inch	1.39"	.750"		4.7 oz	MSR
V4002M	Ultra High	MSR Ideal Height	30mm	1.40"	.750"		4.7 oz	1 PIECE
V4012M [20MDA]	Ultra High	MSR Ideal Height	30mm	1.39"	.750"		4.7 oz	MSR

NEW for 2022

* All sizes listed are approximate, every firearm and scope set up varies.

† For the RINGS - Measurement is from top of base to the bottom of scope tube. (see diagram example on page 14)

† For the 1 PIECE MOUNTS - Measurement is from the top of the rail to the center of the scope tube.



SKYLINE™

PRECISION SHOOTING ACCESSORIES



PRECISION MOUNT

WHY WE DESIGNED THESE:

1 PIECE MODULARITY - The Warne® Skyline™ Precision Mount has been engineered from the ground up with the precision rifle shooter/competitor in mind. Machined from 7075 T6 aluminum billet, featuring 2 integral recoil lugs along with 4 mounting cross bolts and 10 unique accessory mounting locations, the precision mount easily handles the rigors of competition or hard use, military type environments.



PRECISION MOUNT - CANTILEVER, 20MOA



7852M
PRECISION MOUNT LEVEL



7899L
DATA CARD LABEL REFILL - 50pk
**Extra adhesive labels are sold separately*



USL1 [1"], USL30 [30mm],
USL34 [34mm], USL35 [35mm]
UNIVERSAL SCOPE LEVEL



7850M
PRECISION MOUNT 0° ACCESSORY RAIL



7851M
PRECISION MOUNT 90° ACCESSORY RAIL



7854M
PRECISION MOUNT DATA CARD HOLDER*



7855M [30mm], 7856M [34mm],
7857M [35mm]
UNIVERSAL DATA CARD HOLDER*



KEY FEATURES:

- AB**
7075 Billet
- Ns**
NATO/
STANAG
- Hc**
Hardcoat
Anodized Finish
- H₂O**
Element
Proof
- AR**
MSR
Ideal Height

BEST USES:

- LR**
Long
Range
- Ts**
Target
Shooting
- LEM**
LE/Military
- Co**
Competition

- Precision Mount Data Card Holder - Attaches exclusively to the Precision Mount in right or left configurations, and gives shooters a major advantage by its mounting location and ease of use.
- Universal Data Card Holder - Easily attaches to the scope tube, in left or right configurations, for a universal fit. Data is displayed in a convenient location to make quick and accurate target transitions, and the articulating arm allows for low profile storage while not in use.
- Precision Mount Level - Attaches exclusively to the top of the Precision Mount, in left or right configurations, to keep the scope reticle consistently level.
- Universal Scope Mount Level - Easily attaches to scope tube, in left or right configurations, to keep the scope reticle level without changing position on the rifle.
- Precision Mount 0° Accessory Rail - Attaches exclusively to the Precision Mount in 0° & 45° configurations.
- Precision Mount 90° Accessory Rail - Attaches exclusively to the Precision Mount in a 90° configuration.
- Data Card Label Refill - Adhesive labels come in a 50 pack to replace when needed.

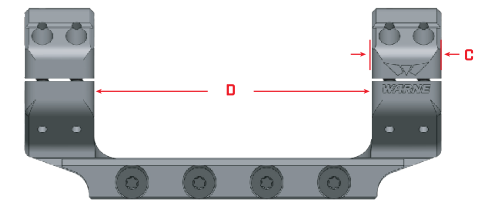
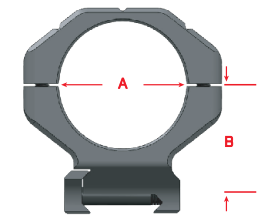

PART NUMBER	RING HEIGHT	FITS OBJECTIVE SIZE* <i>[General Ranges]</i>	DIMENSION A	DIMENSION B†	DIMENSION C	DIMENSION D	WEIGHT	MOUNT STYLE
7814M	Medium	Up to 68mm outside	30mm	1.181"	.813"	3.23"	7.10 oz	Standard, 0MOA
7817M	Ultra High	MSR Ideal Height	30mm	1.386"	.813"	3.23"	7.50 oz	Standard, 0MOA
7818M 7818-20MOA	Ultra High	MSR Ideal Height	30mm	1.540"	.813"	3.23"	6.40 oz	Cantilever, 0MOA Cantilever, 20MOA
7821M	Medium	Up to 72mm outside	34mm	1.181"	.813"	3.23"	7.10 oz	Standard, 0MOA
7824M	Ultra High	MSR Ideal Height	34mm	1.386"	.813"	3.23"	7.50 oz	Standard, 0MOA
7825M 7825-20MOA	Ultra High	MSR Ideal Height	34mm	1.540"	.813"	3.23"	6.40 oz	Cantilever, 0MOA Cantilever, 20MOA
7841M	Medium	Up to 72mm outside	35mm	1.181"	.813"	3.23"	7.10 oz	Standard, 0MOA
7842M 7842-20MOA	Ultra High	MSR Ideal Height	35mm	1.540"	.813"	3.23"	6.40 oz	Cantilever, 0MOA Cantilever, 20MOA
7844M	Ultra High	MSR Ideal Height	35mm	1.386"	.813"	3.23"	7.50 oz	Standard, 0MOA

* All sizes listed are approximate, every firearm and scope set up varies.
† Measurement is from the top of the rail to the center of the scope tube.

SKYLINE™

PRECISION SHOOTING ACCESSORIES



**7901M
PRECISION BIPOD PICATINNY**

WHY WE DESIGNED THESE:

BIPOD PERFECTION ACHIEVED - The Warne® Skyline™ Precision Bipod is the most functional, ergonomic and strongest bipod on the market today. Designed to attach to your picatinny or ARCA rail, the Skyline™ bipod allows the shooter to make quick, one-handed height adjustments, as well as smooth cant and panning ability for use on uneven terrain or less than ideal positions.

- Quickly attaches to any Picatinny type rail [7901M] or ARCA rail [7902M]
- Rapid deploy legs lock at: 0°, 45°, 90°
- One handed adjustability
- 22° total cant/44° total pan
- Panning movement can be disabled, allowing only cant.
- Design Patent 10,408,555 & 10,794,655



KEY FEATURES:

AB 7075 Billet	AL Aluminum	Hc Hardcoat Anodized Finish	QD Quick Detach
--------------------------	-----------------------	---------------------------------------	---------------------------

BEST USES:

LR Long Range	TS Target Shooting	LEM LE/Military	Hu Hunting
-------------------------	------------------------------	---------------------------	----------------------

SKYLINE PRECISION BIPOD



**7902M
PRECISION BIPOD ARCA RAIL**

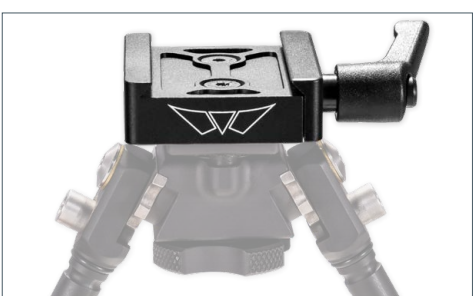

**7955M
ARCA RAIL ADAPTER FOR ATLAS BIPOD**
Atlas® is a registered trademark of B&T Industries LLC



**7957M
PRECISION BIPOD ARCA ADAPTER**



**7956M
ARCA RAIL ADAPTER FOR SWIVEL STUD STYLE BIPOD**



**7950M
PRECISION BIPOD SPIKE FEET**



**7951M
PRECISION BIPOD CLAW FEET**



**7954M
PRECISION BIPOD ATLAS® FOOT ADAPTER**
Atlas® is a registered trademark of B&T Industries LLC



**7953M
SLING SWIVEL ADAPTER**
Picatinny rail adapter that mounts to a rifle's existing sling swivel, allowing the use of picatinny style bipods.



**7952M
PRECISION BIPOD EXTENSION LEGS**
Additional 3" of height, giving an overall 12" of total lift.

To extend the Bipod legs, simply pull out to desired height. Legs can be retracted one position at a time by pressing in on the height ratchet lever. To fully retract legs, press in on the ratchet lever AND while holding in, press down to retract.

- Standard Leg Extension
min height: 6.9"
max height: 9.1"



TACTICAL

MSR 1 PIECE MOUNTS

WHY WE DESIGNED THESE:

STYLISH 1 PIECE CANTILEVER MSR MOUNT - Designed to have the "Ideal Height" for Modern Sporting Rifles, the X-SKEL® places the optic at the proper height and forward position on AR platforms. Skeletonized design along with steel hardware and threaded inserts provides a lightweight and rigid mounting platform.

- The X-SKEL® Mount is our most popular one piece mounting system used in competition and hunting trips worldwide.
- The LR-SKEL Mount offers 20 MDA built-in slope for long range precision shooting. This allows additional elevation adjustment in your optic when shooting ranges over 600 yards.
- The SUPER HIGH X-SKEL® Places optic at correct height for heads up/CQB shooting positions.
- The QD X-SKEL Patent pending dual quick detach levers for fast toolless installation and removal.
- The Rapid Acquisition Multi-Sight Platform, or R.A.M.P., is our Gen 1 cantilever-style scope mounting platform that allows correct scope installation on the popular AR-15 rifle, and also offers unique 45° mounting rails on both sides of the optic.

KEY FEATURES:

AL	Hc	Ck	AR	QD	RtZ	Si	LW
Aluminum	Hardcoat Anodized Finish	Cerakote Finish	MSR Ideal Height	Quick Detach	Return to Zero	Steel Inserts	Lightweight

BEST USES:

LR	Ts	Hu	LEm	Co
Long Range	Target Shooting	Hunting	LE/Military	Competition

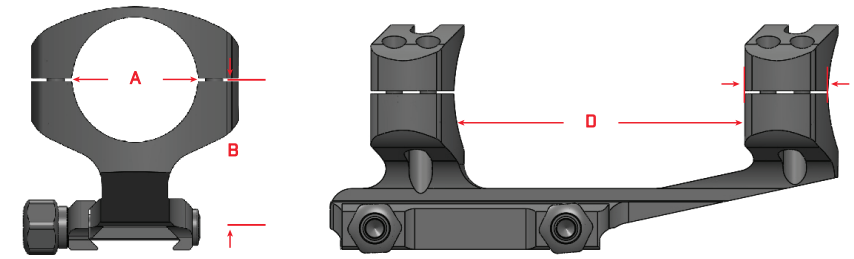

PART NUMBER	RING HEIGHT	FITS OBJECTIVE SIZE* [General Ranges]	DIMENSION A	DIMENSION B†	DIMENSION C	WEIGHT	FINISH COLOR
XSKEL1	Ultra High	MSR Ideal Height	1 inch	1.435"	.750"	6.7 oz	Black, Red, Blue, Dark Earth, OD Green, Tactical Grey
XSKEL30	Ultra High	MSR Ideal Height	30mm	1.435"	.750"	6.7 oz	Black, Red, Blue, Dark Earth, OD Green, Tactical Grey
XSKEL34	Ultra High	MSR Ideal Height	34mm	1.435"	.750"	6.7 oz	Black, Red, Blue, Dark Earth, OD Green, Tactical Grey
QDXSKEL1	Ultra High	MSR Ideal Height	1 inch	1.435"	.750"	8.2 oz	Black, Dark Earth
QDXSKEL30	Ultra High	MSR Ideal Height	30mm	1.435"	.750"	8.2 oz	Black, Dark Earth
QDXSKEL34	Ultra High	MSR Ideal Height	34mm	1.435"	.750"	8.5 oz	Black, Dark Earth
LRSKEL1 [20MDA]	Ultra High	MSR Ideal Height	1 inch	1.435"	.750"	6.7 oz	Black, Dark Earth, Tactical Grey
LRSKEL30 [20MDA]	Ultra High	MSR Ideal Height	30mm	1.435"	.750"	6.7 oz	Black, Dark Earth, Tactical Grey
LRSKEL34 [20MDA]	Ultra High	MSR Ideal Height	34mm	1.435"	.750"	6.7 oz	Black, Dark Earth, Tactical Grey
RAMP1	Ultra High	MSR Ideal Height	1 inch	1.435"	.750"	9.5 oz	Black
RAMP30	Ultra High	MSR Ideal Height	30mm	1.435"	.750"	9.5 oz	Black
SHXSKEL30	Super High	Any	30mm	1.90"	.750"	7.8 oz	Black, Dark Earth
SHXSKEL34	Super High	Any	34mm	1.90"	.750"	7.8 oz	Black, Dark Earth

* All sizes listed are approximate, every firearm and scope set up varies.
† Measurement is from the top of the rail to the center of the scope tube.

DETERMINING YOUR ORDER NUMBER:

Combine Part Number with the Available Finish Letter at the end:
TW=Black R=Red B=Blue DE=Dark Earth OD=OD Green
TG=Tactical Grey [Example: XSKEL1 + Red= XSKEL1R]

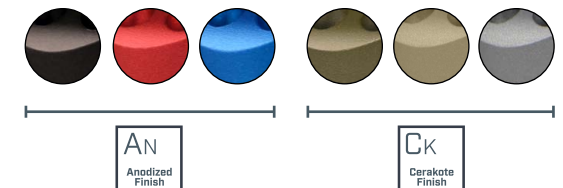

TACTICAL 1 PIECE MSR MOUNTS



X-SKEL



LR-SKEL



Super High X-SKEL®



QD X-SKEL



R.A.M.P.

TACTICAL

ACCESSORY MOUNTS

WHY WE DESIGNED THESE:

COMPACT 45 DEGREE RAIL - The Warne® A645 is designed as a 45° offset picatinny rail for mounting secondary sighting systems and other accessories.

PART NUMBER	FINISH COLOR
A645TW	Black
A645R	Red
A645BU	Blue
A645DE	Dark Earth
A645OD	OD Green
A645TG	Tactical Grey

KEY FEATURES:

AL	AN	CK	LW
Aluminum	Anodized Finish	Cerakote Finish	Lightweight

BEST USES:

Co	Ts	LEM
Competition	Target Shooting	LE/Military



TACTICAL

RED DOT MOUNTS

NEW
for
2022

WHY WE DESIGNED THESE:

VERSATILE RED DOT RISER - With the increasing number of electro optics being used, finding a compatible mounting system can be confusing. We designed our modular Red Dot Riser to fit a wide range of different optics based on the mount footprint or attachment style. All riser mounts that we offer share a robust mounting base, while the top is engineered specifically for different red dot styles.

KEY FEATURES:

AL	AN	CK	LW	LW
Aluminum	Anodized Finish	Cerakote Finish	Lightweight	Lightweight

BEST USES:

Co	Ts	LEM
Competition	Target Shooting	LE/Military



6101M
T1-T2 Interface



6102M
Picatinny Rail



6103M
Reflex

PART NUMBER	MOUNT STYLE
6101M	T1-T2 Interface
6102M	Picatinny Rail
6103M	Reflex



TACTICAL

MAGZINE EXTENSIONS

KEY FEATURES:

AL Aluminum	AN Anodized Finish	Zc Zero Capacity	Mc Mid Capacity	Lc Large Capacity
----------------	-----------------------	---------------------	--------------------	----------------------

BEST USES:

Co Competition	Ts Target Shooting
-------------------	-----------------------

WHY WE DESIGNED THESE:

VERSATILE RED DOT RISER - Warne® Handgun Magazine Extensions are available in both increased capacity models, and zero capacity models for 10 round capacity limits. These extensions feature an ergonomic shape that allows for better insertion, and finger grooves, allowing the magazine to be stripped from the handgun if needed.

- Machined from 6061 T6 aluminum billet
- Type 2 hardcoat anodize finish for abrasion and corrosion resistance
- T-10 Torx head screw and washer for retention
- Designed and Made in USA



PART NUMBER	HANDGUN MODEL	CAPACITY	FINISH COLOR
3101	Glock 17 & 22	+0	Black
3102	Glock 17 & 22	+0	Blue
3103	Glock 17 & 22	+0	Dark Earth
3104	Glock 17 & 22	+0	Grey
3105	Glock 17 & 22	+0	Red
3106	Glock 17 & 22	+3, 9mm/+2, 40cal.	Black
3107	Glock 17 & 22	+3, 9mm/+2, 40cal.	Blue
3108	Glock 17 & 22	+3, 9mm/+2, 40cal.	Dark Earth
3109	Glock 17 & 22	+3, 9mm/+2, 40cal.	Grey
3110	Glock 17 & 22	+3, 9mm/+2, 40cal.	Red
3111	Glock 17 & 22	+5, 9mm/+4, 40cal.	Black
3112	Glock 17 & 22	+5, 9mm/+4, 40cal.	Blue
3113	Glock 17 & 22	+5, 9mm/+4, 40cal.	Dark Earth
3114	Glock 17 & 22	+5, 9mm/+4, 40cal.	Grey
3115	Glock 17 & 22	+5, 9mm/+4, 40cal.	Red
3116	Glock 19 & 23	+0	Black
3117	Glock 19 & 23	+0	Blue
3118	Glock 19 & 23	+0	Dark Earth
3119	Glock 19 & 23	+0	Grey
3120	Glock 19 & 23	+0	Red
3121	Glock 19 & 23	+3, 9mm/+2, 40cal.	Black
3122	Glock 19 & 23	+3, 9mm/+2, 40cal.	Blue
3123	Glock 19 & 23	+3, 9mm/+2, 40cal.	Dark Earth
3124	Glock 19 & 23	+3, 9mm/+2, 40cal.	Grey
3125	Glock 19 & 23	+3, 9mm/+2, 40cal.	Red
3126	Glock 19 & 23	+5, 9mm/+4, 40cal.	Black
3127	Glock 19 & 23	+5, 9mm/+4, 40cal.	Blue
3128	Glock 19 & 23	+5, 9mm/+4, 40cal.	Dark Earth
3129	Glock 19 & 23	+5, 9mm/+4, 40cal.	Grey
3130	Glock 19 & 23	+5, 9mm/+4, 40cal.	Red
3131	Glock 42	+2	Black
3132	Glock 43	+2	Black
3133	Glock 43X & 48	+2	Black

PART NUMBER	HANDGUN MODEL	CAPACITY	FINISH COLOR
3201	Sig Sauer P320	+0, 9mm	Black
3202	Sig Sauer P320	+0, 9mm	Blue
3203	Sig Sauer P320	+0, 9mm	Dark Earth
3204	Sig Sauer P320	+0, 9mm	Grey
3205	Sig Sauer P320	+0, 9mm	Red
3206	Sig Sauer P320	+3/2, 9mm	Black
3207	Sig Sauer P320	+3/2, 9mm	Blue
3208	Sig Sauer P320	+3/2, 9mm	Dark Earth
3209	Sig Sauer P320	+3/2, 9mm	Grey
3210	Sig Sauer P320	+3/2, 9mm	Red
3211	Sig Sauer P320	+5/4, 9mm	Black
3212	Sig Sauer P320	+5/4, 9mm	Blue
3213	Sig Sauer P320	+5/4, 9mm	Dark Earth
3214	Sig Sauer P320	+5/4, 9mm	Grey
3215	Sig Sauer P320	+5/4, 9mm	Red
3301	Smith & Wesson M&P 9 & 40	+0	Black
3302	Smith & Wesson M&P 9 & 40	+0	Blue
3303	Smith & Wesson M&P 9 & 40	+0	Dark Earth
3304	Smith & Wesson M&P 9 & 40	+0	Grey
3305	Smith & Wesson M&P 9 & 40	+0	Red
3306	Smith & Wesson M&P 9 & 40	+3, 9mm/+2, 40cal.	Black
3307	Smith & Wesson M&P 9 & 40	+3, 9mm/+2, 40cal.	Blue
3308	Smith & Wesson M&P 9 & 40	+3, 9mm/+2, 40cal.	Dark Earth
3309	Smith & Wesson M&P 9 & 40	+3, 9mm/+2, 40cal.	Grey
3310	Smith & Wesson M&P 9 & 40	+3, 9mm/+2, 40cal.	Red
3311	Smith & Wesson M&P 9 & 40	+5, 9mm/+4, 40cal.	Black
3312	Smith & Wesson M&P 9 & 40	+5, 9mm/+4, 40cal.	Blue
3313	Smith & Wesson M&P 9 & 40	+5, 9mm/+4, 40cal.	Dark Earth
3314	Smith & Wesson M&P 9 & 40	+5, 9mm/+4, 40cal.	Grey
3315	Smith & Wesson M&P 9 & 40	+5, 9mm/+4, 40cal.	Red



PART NUMBER	HANDGUN MODEL	CAPACITY	FINISH COLOR
3001	CZ 75	+0	Black
3002	CZ 75	+0	Blue
3003	CZ 75	+0	Dark Earth
3004	CZ 75	+0	Grey
3005	CZ 75	+0	Red
3006	CZ 75	+3, 9mm	Black
3007	CZ 75	+3, 9mm	Blue
3008	CZ 75	+3, 9mm	Dark Earth
3009	CZ 75	+3, 9mm	Grey
3010	CZ 75	+3, 9mm	Red
3011	CZ 75	+4, 9mm	Black
3012	CZ 75	+4, 9mm	Blue
3013	CZ 75	+4, 9mm	Dark Earth
3014	CZ 75	+4, 9mm	Grey
3015	CZ 75	+4, 9mm	Red

WARNE

MOUNTING TOOLS

WHY WE DESIGNED THESE:

THE RIGHT TOOL FOR THE JOB - Designed to make the installation of our mounts and accessories easy, Warne's Range Tool and fixed torque wrenches make a great addition to every range bag.

TW65 TORQUE WRENCH 65IN/LBS



This tool allows the shooter to precisely tighten the 1/2" hex nut (on Warne's MSR & Tactical Mounts) to the proper torque setting of 65 in/lb. This is indicated when the red light is lit up and an audible beep has been heard.

RT-1 RANGE TOOL

Warne's Range Tool is designed to be the go-to multi-tool for every shooter's range bag. This compact and durable tool features 12 of the most popular driver bits to perform basic firearm maintenance and scope adjustment in the field.

- Aluminum handle
- Chrome vanadium steel bits
- Pin remover size: 0.10"
- Flat blade screwdriver
- #2 Phillips head screwdriver
- Allen head sizes: 0.05", 1/16", 5/64", 3/32", 1/8" & 5/32"
- Torx driver sizes: T10, T15 & T20



MOUNTING TOOLS



TACTICAL HANDGUN MAGAZINE EXTENSIONS



WHY YOU NEED IT:

SHOW YOUR WARNE PRIDE - Our branded swag is comfortable and stylish to fit a versatile lifestyle. With a variety of fabric and logos colors, our shirts and hats give you the option for a stand-out or subdued look.



KEY FEATURES:

AB 7075 Billet	AL Aluminum	Hc Hardcoat Anodized Finish	QD Quick Detach
--------------------------	-----------------------	---------------------------------------	---------------------------

BEST USES:

LR Long Range	Ts Target Shooting	LEM LE/Military	HU Hunting
-------------------------	------------------------------	---------------------------	----------------------

PART NUMBER	SIZE	SHIRT COLOR	PRINT DESIGN
T1004S T1004M T1004L T1004XL T1004XXL T1004XXXL	Small Medium Large XL 2XL 3XL	Black	Warne logo, front center Tag line, right sleeve

T1003S T1003M T1003L T1003XL T1003XXL T1003XXXL	Small Medium Large XL 2XL 3XL	Black	Warne logo/tag line, front left crest Warne logo, back collar
--	--	-------	---

T1002S T1002M T1002L T1002XL T1002XXL T1002XXXL	Small Medium Large XL 2XL 3XL	Charcoal	Warne logo/tag line, front left crest Warne logo, back collar
--	--	----------	---

T1001S T1001M T1001L T1001XL T1001XXL T1001XXXL	Small Medium Large XL 2XL 3XL	OD Green	Warne logo/tag line, front left crest Warne logo, back collar US Flag, right sleeve
--	--	----------	--

Professionally screen printed on Sport-Tek® PosiCharge® Competitor™ Tee. Lightweight, roomy and highly breathable, these moisture-wicking tees feature PosiCharge technology to lock in color and prevent logos from fading.

- 3.8-ounce, 100% polyester interlock with PosiCharge technology
- Removable tag for comfort
- Set-in sleeves
- Unisex fit (*more info on our website*)



PART NUMBER	HAT COLOR	HAT DETAILS
H1002	Charcoal/Black	Synthetic black linen material and standard grey trucker mesh
H1003	Grey/White	Grey chino twill material and standard white trucker mesh
H1001	OD Green/Brown	OD Green twill material and standard brown trucker mesh
H1004	Orange/Black	Blaze orange twill material and standard black trucker mesh

- Structured modern fit
- Snap back closure for ease of fitment
- One size fits all
- No top button for over the head hearing protection comfort



WHO IS TEAM WARNE:

THE BEST AMBASSADORS - Team Warne® is simply the best of the best. We have countless shooters across the globe sporting our logo and running our gear. These 15 shooters are just a small handful of those who love and trust Warne® products. They are amazing individuals, the salt of the earth people, who have been using our products for years and who go out of their way to help new shooters and educate them on the Warne® brand.

For more info and bios, check out our website at: warnescopemounts.com/team-warne.

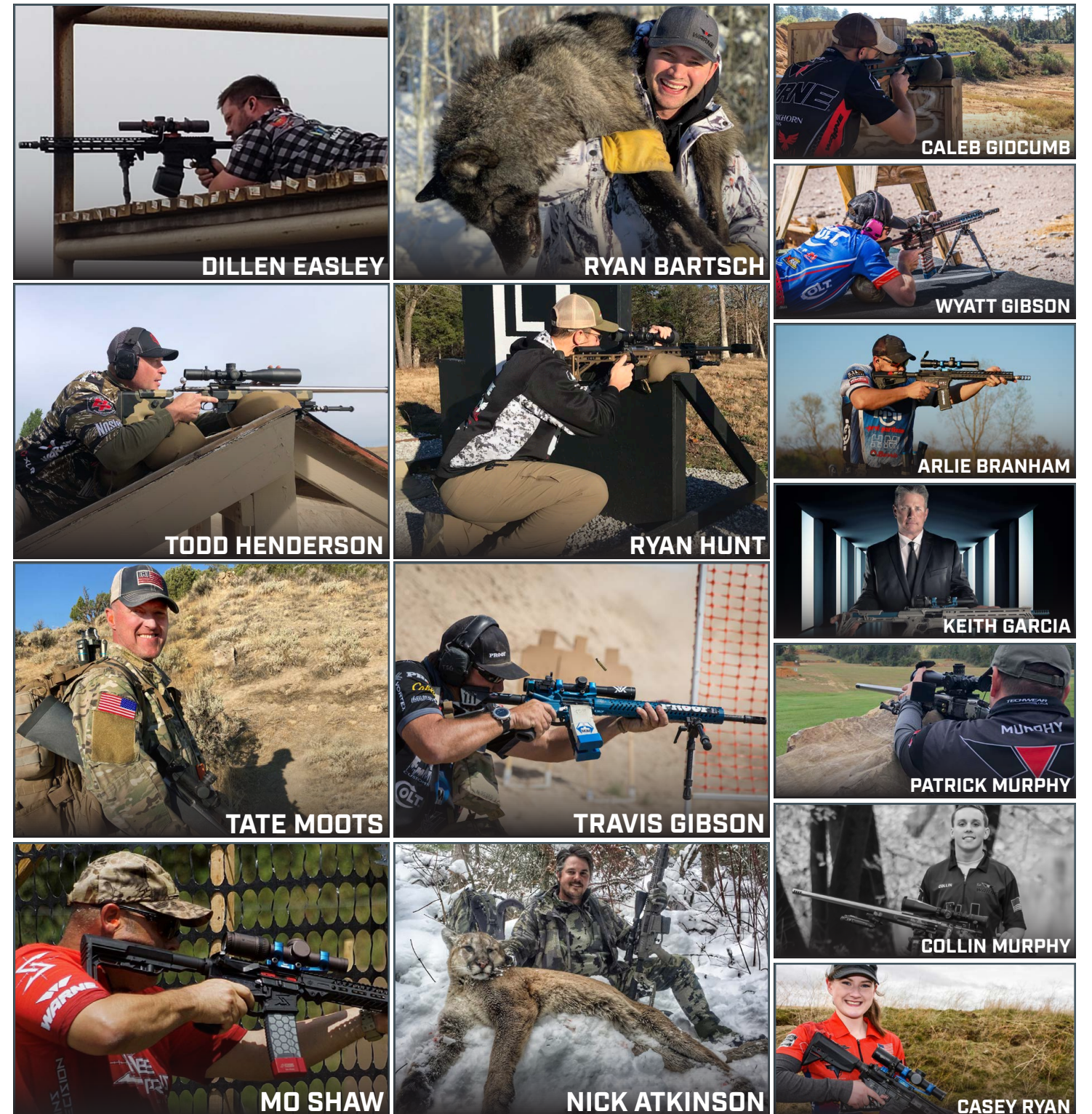

TEAM WARNE PRO STAFF

WARNE SWAG



WARNE SCOPE MOUNTS
9500 SW TUALATIN ROAD
TUALATIN, OR 97062 USA

WARNESCOPEMOUNTS.COM