

# INSTRUCTION MANUAL FOR



## RUGER® LCP® MAX



– Rugged, Reliable Firearms® –



**READ THE INSTRUCTIONS AND  
WARNINGS IN THIS MANUAL CAREFULLY  
BEFORE USING THIS FIREARM**

© 2021 Sturm, Ruger & Co., Inc.

This manual may not be reproduced in whole or in part without the express written permission of Sturm, Ruger & Co., Inc.

**For Service on This Model Please Call:  
(336) 949-5200 (See p. 37)**

THIS INSTRUCTION MANUAL SHOULD ALWAYS ACCOMPANY THIS FIREARM AND BE TRANSFERRED WITH IT UPON CHANGE OF OWNERSHIP, OR WHEN THE FIREARM IS LOANED OR PRESENTED TO ANOTHER PERSON

Ruger.com

LCP MAX 11/2021 R1

## State-By-State Warnings

Certain states require by law that their own specified warning notices in larger-than-normal type be conspicuously included by the manufacturer, distributor or retailer with firearms sold in that state. Sturm, Ruger & Co., Inc. sells its products in compliance with applicable laws and regulations. Because our products may be sold in these states, we include the following:

### **California:**

#### **WARNING**

“Firearms must be handled responsibly and securely stored to prevent access by children and other unauthorized users. California has strict laws pertaining to firearms, and you may be fined or imprisoned if you fail to comply with them. Visit the Web site of the California Attorney General at <https://oag.ca.gov/firearms> for information on firearm laws applicable to you and how you can comply.

Prevent child access by always keeping guns locked away and unloaded when not in use. If you keep a loaded firearm where a child obtains and improperly uses it, you may be fined or sent to prison.

If you or someone you know is contemplating suicide, please call the national suicide prevention lifeline at 1-800-273-TALK (8255).”

#### **ADVERTENCIA**

“Las armas de fuego deben manipularse de manera responsable y segura para evitar el acceso de niños y otros usuarios no autorizados. California tiene leyes estrictas relacionadas con armas de fuego, y usted puede ser multado o encarcelado si no las cumple. Visite el sitio web del Procurador General de California en <https://oag.ca.gov/firearms> para obtener información sobre las leyes de armas de fuego que le son aplicables y cómo puede cumplirlas.

A los niños los atraen las armas de fuego y las pueden hacer funcionar. Ellos pueden causarse lesiones graves y la muerte. Evite que los niños tengan acceso a las armas de fuego guardándolas siempre con llave y descargadas cuando no las esté utilizando. Si usted tiene un arma de fuego cargada en un lugar en que un niño tiene acceso a ella y la usa indebidamente, le pueden dar una multa o enviarlo a la cárcel.

Si usted o alguien que conoce está pensando en suicidarse, llame a la línea nacional de prevención del suicidio al 1-800-273-TALK (8255).”

### **Connecticut:**

“UNLAWFUL STORAGE OF A LOADED FIREARM MAY RESULT IN IMPRISONMENT OR FINE.”

### **Florida:**

“IT IS UNLAWFUL, AND PUNISHABLE BY IMPRISONMENT AND FINE, FOR ANY ADULT TO STORE OR LEAVE A FIREARM IN ANY PLACE WITHIN THE REACH OR EASY ACCESS OF A MINOR UNDER 18 YEARS OF AGE OR TO KNOWINGLY SELL OR OTHERWISE TRANSFER OWNERSHIP OR POSSESSION OF A FIREARM TO A MINOR OR A PERSON OF UNSOUND MIND.”

### **Maine:**

“ENDANGERING THE WELFARE OF A CHILD IS A CRIME. IF YOU LEAVE A FIREARM AND AMMUNITION WITHIN EASY ACCESS OF A CHILD, YOU MAY BE SUBJECT TO FINE, IMPRISONMENT OR BOTH. KEEP FIREARMS AND AMMUNITION SEPARATE. KEEP FIREARMS AND AMMUNITION LOCKED UP. USE TRIGGER LOCKS.”

### **Maryland:**

“WARNING: Children can operate firearms which may cause death or serious injury. It is a crime to store or leave a loaded firearm in any location where an individual knew or should have known that an unsupervised minor would gain access to the firearm. Store your firearm responsibly!”

## **Massachusetts:**

“WARNING FROM THE MASSACHUSETTS ATTORNEY GENERAL: This handgun is not equipped with a device that fully blocks use by unauthorized users. More than 200,000 firearms like this one are stolen from their owners every year in the United States. In addition, there are more than a thousand suicides each year by younger children and teenagers who get access to firearms. Hundreds more die from accidental discharge. It is likely that many more children sustain serious wounds, or inflict such wounds accidentally on others. In order to limit the chance of such misuse, it is imperative that you keep this weapon locked in a secure place and take other steps necessary to limit the possibility of theft or accident. Failure to take reasonable preventive steps may result in innocent lives being lost, and in some circumstances may result in your liability for these deaths.”

“IT IS UNLAWFUL TO STORE OR KEEP A FIREARM, RIFLE, SHOTGUN OR MACHINE GUN IN ANY PLACE UNLESS THAT WEAPON IS EQUIPPED WITH A TAMPER-RESISTANT SAFETY DEVICE OR IS STORED OR KEPT IN A SECURELY LOCKED CONTAINER.”

## **New Jersey:**

“IT IS A CRIMINAL OFFENSE TO LEAVE A LOADED FIREARM WITHIN EASY ACCESS OF A MINOR.”

## **New York City:**

“THE USE OF A LOCKING DEVICE OR SAFETY LOCK IS ONLY ONE ASPECT OF RESPONSIBLE FIREARM STORAGE. FOR INCREASED SAFETY, FIREARMS SHOULD BE STORED UNLOADED AND LOCKED IN A LOCATION THAT IS BOTH SEPARATE FROM THEIR AMMUNITION AND INACCESSIBLE TO CHILDREN AND UNAUTHORIZED PERSONS.”

**North Carolina:**

“IT IS UNLAWFUL TO STORE OR LEAVE A FIREARM THAT CAN BE DISCHARGED IN A MANNER THAT A REASONABLE PERSON SHOULD KNOW IS ACCESSIBLE TO A MINOR.”

**Texas:**

“IT IS UNLAWFUL TO STORE, TRANSPORT, OR ABANDON AN UNSECURED FIREARM IN A PLACE WHERE CHILDREN ARE LIKELY TO BE AND CAN OBTAIN ACCESS TO THE FIREARM.”

**Wisconsin:**

“IF YOU LEAVE A LOADED FIREARM WITHIN THE REACH OR EASY ACCESS OF A CHILD YOU MAY BE FINED OR IMPRISONED OR BOTH IF THE CHILD IMPROPERLY DISCHARGES, POSSESSES, OR EXHIBITS THE FIREARM.”

\* \* \* \* \*

Please check with your licensed retailer or state police for additional warnings which may be required by local law or regulation. Such regulations change constantly, and local authorities are in the best position to advise you on such legal matters.

**FIREARMS SAFETY IS YOUR RESPONSIBILITY**  
**SAFETY MUST BE THE FIRST AND CONSTANT**  
**CONSIDERATION OF EVERY PERSON WHO HANDLES**  
**FIREARMS AND AMMUNITION.**

This Instruction Manual is designed to assist you in learning how to use and care for your **RUGER® LCP® MAX** pistol. Please contact us if you have any questions.

Only when you are certain you fully understand the manual and can properly carry out its instructions should you practice loading, unloading, etc. with live ammunition. If you have any doubts about your ability to handle or use a particular type of firearm safely, you should seek supervised instruction. Such personalized instruction often is available from local firearm retailers, gun clubs or police departments. If none of these sources can help, visit [nra.org](http://nra.org) or write to the following address:

National Rifle Association  
11250 Waples Mill Road  
Fairfax, VA 22030-7400

The person possessing a firearm has a full-time job. You cannot guess; you cannot forget. You must know how to use your firearm safely. **Do not use any firearm without having a complete understanding of its particular characteristics and safe use.** Remember: There is no such thing as a foolproof firearm.

## TABLE OF CONTENTS

State-By-State Warnings	2
Nomenclature	8
Locking Device Installation Instructions	9
General Information and Mechanical Characteristics	11
Operation of Controls (Slide Stop; Magazine Release; Reversible Magazine Release)	12
Dry Firing	17
Ammunition	17
Magazines	19
To Load and Fire	21
To Reload the Pistol	22
To Load and Fire (Without a Magazine)	22
To Unload	24
To Extract and Eject a Chambered Cartridge	25
To Clear a Malfunction (“Jam” or “Misfire”)	26
To Minimize Malfunctions (“Jams” or “Misfires”)	27
Disassembly	27
Inspection, Cleaning, and Lubrication	31
Reassembly	32
Check Your Pistol’s Function	34
Sight Adjustment	35
Storage	36
Service and Parts Policy	37
Shipping Firearms for Repair	37
Ordering Parts	38
Parts List	39
Exploded View	41
<b>The Basic Rules of Safe Firearms Handling</b>	<b>42</b>
Warranty Information	48

“Ruger” is a registered U.S. trademark.



### WARNINGS OF GREAT IMPORTANCE ARE FOUND ON THE FOLLOWING PAGES:

Locking Devices	9	Slide Retraction	25
Alterations	11	Malfunctions	26
Lead Exposure	18	Disassembly	27
Ammunition	18	Lubrication	32
Firing	23	Storage	36
Handling	23	Shipping	37
Unloading	23	Parts Purchasers	38

**OTHER CAUTIONS AND WARNINGS APPEAR  
THROUGHOUT THE MANUAL.**

# NOMENCLATURE



Automatic last round Hold Open / Slide Stop allows the slide to be locked to the rear to positively view the cartridge chamber. The hold open is spring loaded downward so it is released by pulling the slide slightly rearward.





## LOCKING DEVICE INSTALLATION INSTRUCTIONS



### WARNING – USE OF LOCKING DEVICES



**Do not store keys  
in lock.**

- Always keep your firearm pointed in a safe direction, including when you are installing or removing your locking device.
- Always verify that your firearm is completely unloaded before installing your locking device.
- Do not install locking devices in the trigger guard unless the instructions specifically require it; otherwise always keep your fingers and locking device outside the trigger guard during device installation and removal.
- Store firearms, ammunition and keys separately and securely, away from children and careless adults; do not store your firearm with the keys in the locking device.
- Do not attempt to work the action of your firearm with the locking device in place; this may damage your firearm.
- While locking devices are an important aid to security measures, they are not a substitute for safe firearm handling and proper storage. Remember that any mechanical device can be bypassed with enough time, knowledge, determination and equipment.

**LOCKING DEVICES MUST BE USED  
SAFELY AND RESPONSIBLY**

It is important to use the locking device on your Ruger® firearm when the firearm is stored or immediate use is not planned.

Keep the muzzle pointed in a safe direction and your fingers outside the trigger guard at all times during installation of the locking device!

#### **To Install the Factory-Supplied Locking Device:**

1. Remove the magazine from your pistol.
2. Open the action completely, and verify that the firearm is completely unloaded and contains no cartridges or cartridge cases!

Use the slide stop to keep the action open during installation of the locking device.

3. Insert the cable directly into your pistol as shown in Figure 1.
4. To lock: With the key turned to the farthest clockwise position, insert the loose end of the cable into the lock. Turn the key counterclockwise and remove the key.
5. Once the lock is securely closed, pull firmly on the lock to test the connection and be sure it is locked. **Do not leave or store your firearm with the key in the lock!** Store your locked, unloaded firearm and the key in secure, separate locations, away from ammunition, children, and unauthorized adults.

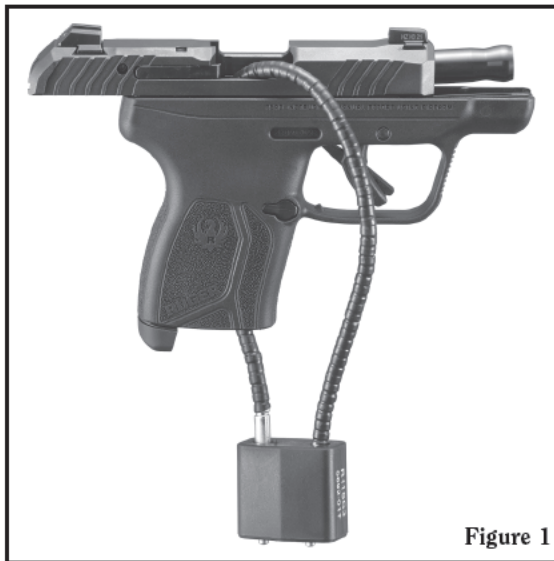

Figure 1

Correct installation of the lock on a Ruger® LCP® MAX pistol.

**FIREARMS ARE DANGEROUS WEAPONS.  
READ THE INSTRUCTIONS AND WARNINGS  
IN THIS MANUAL THOROUGHLY AND  
CAREFULLY BEFORE USING.**

 <b>WARNING - ALTERATIONS</b>	
	This product was designed to function properly in its original condition. Alterations can make it unsafe. Do not alter any part or add or substitute parts or accessories not made or sold by Sturm, Ruger & Co., Inc.
	<b>DO NOT ALTER ANY FIREARM</b>

## GENERAL INFORMATION AND MECHANICAL CHARACTERISTICS

The **RUGER® LCP® MAX** pistol is a compact, centerfire, Secure Action™, magazine-fed, recoil-operated pistol chambered for the .380 Auto cartridge. The **RUGER® LCP® MAX** pistol features a Secure Action™ fire control similar to the **RUGER-S7™** and **SECURITY-9®** pistols. Ruger's safe, reliable, and proven Secure Action™ fire-control system combines a protected internal hammer with a bladed safety trigger. The hammer and sear are designed to engage with significant mechanical overlap. This requires additional cocking of the hammer during trigger pull and keeps the hammer and sear securely engaged under the full force of the hammer spring. Additionally, a neutrally balanced sear and strong sear spring ensure continuous, positive engagement of the hammer. The trigger has a short, smooth pull, clean break and positive reset. The double-stack steel magazines and high strength glass fiber nylon grip frame provide a slim comfortable grip not noticeably larger than Ruger's original **LCP II®** pistol. The textured grip frame provides a secure gripping surface in all conditions. The **LCP® MAX** also features: easy no-trigger-pull take-down; steel sights with tritium front sight; and a reversible magazine release. The alloy steel slide features prominent integral cocking ears in addition to refined front and rear cocking serrations. The frame insert is precision CNC machined aluminum with integral frame rails. Specific features and options may vary between models.

**Action:** The strong locked breech action of the **RUGER® LCP® MAX** pistol utilizes a tilting barrel design in which the barrel and slide are locked together at the moment of firing. After firing, the barrel and slide recoil to the rear a short distance while securely locked together. After this initial movement, the barrel is cammed downward from its locked position, permitting full recoil of the slide and the extraction and ejection of the spent cartridge case. Upon return of the slide to its forward position by the recoil spring, the barrel is cammed back upward into its locked position in the slide.

The user of this or any autoloading pistol must always remember that, when fired, the pistol automatically reloads and recocks itself so that simply pulling the trigger again will fire the pistol. Therefore, an autoloading pistol user must be particularly conscious to always keep the pistol pointed in a safe direction.

## OPERATION OF CONTROLS

**Slide Stop:** When the last shot has been fired and the magazine is empty, the slide stop automatically holds the slide open. Likewise, fully retracting the slide manually when there is an empty magazine in the pistol will also hold the slide open. To lock the slide to the rear when there is a loaded magazine inserted in the pistol, or no magazine in the pistol, first point the pistol in a safe direction then fully retract the slide with the non firing hand while pushing up on the bottom of the slide stop with the firing hand (see Figure 2). If a cartridge was chambered, it should extract and eject as you retract the slide manually. Once the slide is locked back, visually inspect the chamber to ensure it is empty.





To release the slide, first remove any inserted empty magazine. Then pull the slide back with the non-firing hand and release it (see Figure 3). If a loaded magazine is inserted, pulling the slide back and letting it go will chamber a cartridge. Keep your fingers away from the trigger and keep the muzzle pointed in a safe direction.

**CAUTION:** When there is a loaded magazine in place and the pistol is jarred, the slide stop may release, causing the slide to fly forward and chamber a cartridge. For this reason and as an essential safety practice, the user should always be careful to keep fingers away from the trigger, and always keep the pistol pointed in a safe direction.



**Magazine Release:** When a magazine is fully inserted into the magazine well, it is automatically held in place by the spring loaded magazine latch. The magazine release is the button to the rear of the trigger guard. When depressed, the magazine release will permit removal of the magazine from the pistol. Under normal conditions, the magazine will fall free of the pistol when the magazine release is depressed. To avoid damage and debris entering the magazine, do not let it fall to the ground. In the event the magazine becomes stuck in the magazine well, it can be manually extracted by pressing the magazine release while pulling on the magazine base pad (see Figure 4).



**WARNING:** Removing the magazine does not prevent the pistol from firing. The firearm can be fired with the magazine removed if there is a cartridge in the chamber. Therefore, an autoloading pistol user must be particularly conscious to always keep the pistol pointed in a safe direction and keep fingers out of the trigger guard and away from the trigger when not firing.

### Reversible Magazine Release:

The magazine release button for the **LCP® MAX** pistol is reversible for operation by the thumb or forefinger of either hand.

To switch the button from one side to the other, first remove the slide to get a clear view of the magazine well (see “Disassembly” instructions p. 28 - 30, steps 1 - 8).

1. **Refer to Figure 5:** Look down into the front of magazine well and locate the magazine latch. There is a wire coming up from the lower part of the magazine well that engages the magazine latch. This wire is both the magazine latch spring and retainer. Using a pointed steel rod, such as scribe, approach the spring from the bottom of the magazine well. Using the tool, push the wire even further to the side it is bent towards while prying it towards the rear of the magazine well until the wire comes free of the latch. The spring will not need to be removed to reverse the magazine latch.

**NOTE:** The non-directional magazine latch spring may come unseated with the magazine release removed. If this happens, simply reinstall the spring into the grip frame slot.



2. Remove the magazine latch by pushing on the serrated button side of the latch (see Figure 6a). The magazine latch must be pushed entirely through the grip frame in order to remove it (see Figure 6b). The serrated edge will need to be rotated up to get around the end of the magazine latch spring, and then down again to remove from the grip frame.

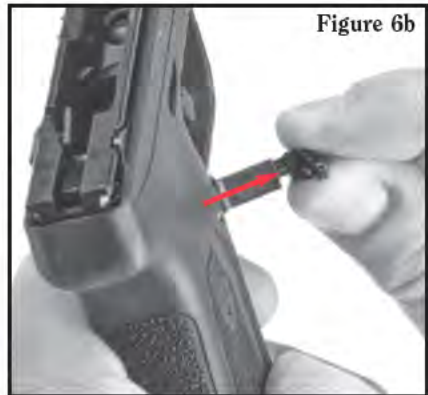
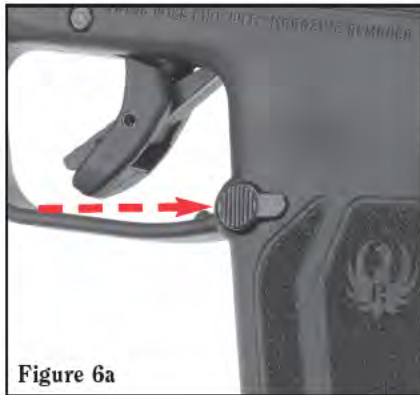

3. Reinstall the magazine latch by starting the serrated end of the latch into the opposite side of the grip frame (see Figure 7a). When the latch reaches the spring, rotate the latch past the spring and then rotate it back to reach the opposite side of the frame. The spring should lay against the flat on the magazine latch (see Figure 7b).

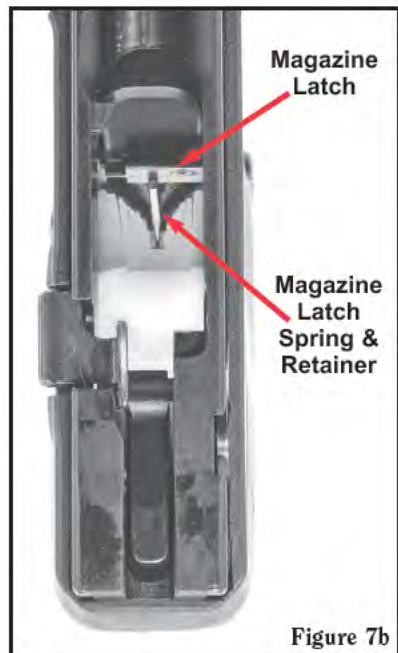

To install with the magazine release button on the right side of the frame for a left-handed shooter, insert the serrated end of the latch from the left side of the frame.

4. Use the pointed scribe to manipulate the wire magazine latch spring sideways, away from the serrated button, until it locks itself into the magazine latch. (See Figure 8.)

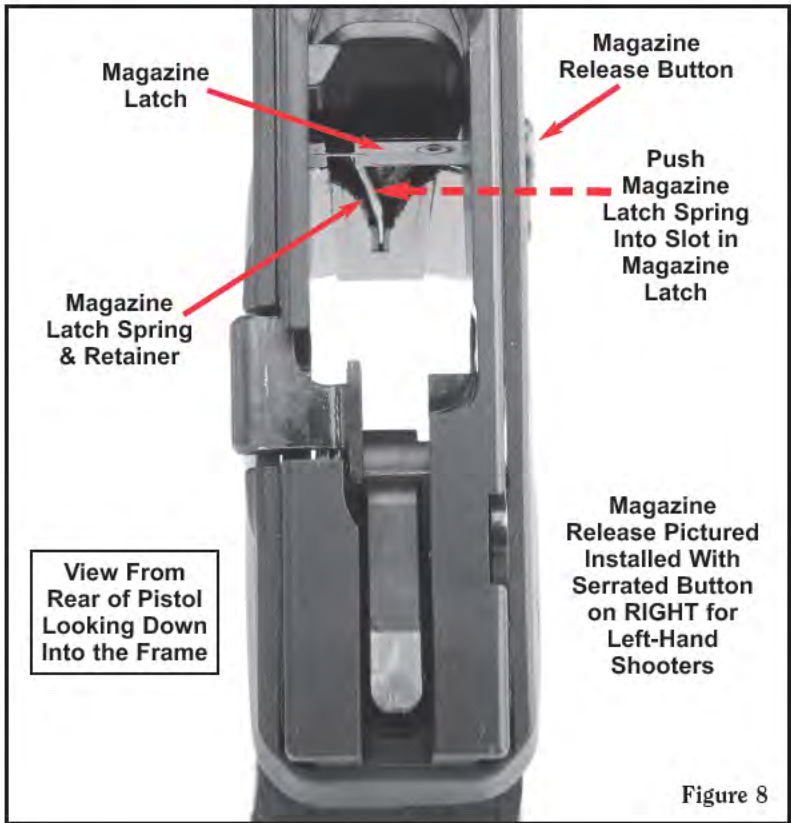



## DRY FIRING

Going through the actions of cocking, aiming and pulling the trigger on an unloaded firearm is known as “dry firing.” It can be useful to learn the “feel” of your pistol. **Practice this important aspect of safe firearm handling with an unloaded pistol until you can perform each of the steps described below with skill and confidence.** Be certain that the pistol is completely unloaded (both the chamber and magazine are empty) and that the pistol is pointing in a safe direction even when you are practicing dry firing. The **RUGER® LCP® MAX** pistol can be dry-fired in moderation without damage to the firing pin or other components. **NOTE:** A snap cap should be used for extensive dry-fire practice.

**NOTE:** When dry firing the **RUGER® LCP® MAX** pistol, the trigger will not automatically move forward to reset. The slide must be fully retracted to reset the trigger and firing mechanism, and then the slide must be allowed to move fully forward. Retracting the slide all the way with an empty magazine inserted will lock the slide open.

## AMMUNITION

The **RUGER® LCP® MAX** pistol is chambered for the 380 Auto cartridge. Do not attempt to load any other cartridges into the magazine or chamber of the pistol. **Do not use “+P” ammunition.**

The **RUGER® LCP® MAX** pistols are compatible with standard factory ammunition loaded to U.S. Industry Standards, including hollow-point loads loaded in brass or aluminum cases. No 380 Auto ammunition manufactured in accordance with NATO, U.S., SAAMI, or CIP standards is known to be beyond the design limits or known not to function in this pistol.

**Do not use “+P” ammunition.**

### AMMUNITION (CARTRIDGES) NOTICE

WE SPECIFICALLY DISCLAIM RESPONSIBILITY FOR ANY DAMAGE OR INJURY WHATSOEVER OCCURRING IN CONNECTION WITH, OR AS A RESULT OF, THE USE IN RUGER® FIREARMS OF FAULTY, OR NON STANDARD, OR “RE MANUFACTURED”, OR HAND LOADED (RELOADED) AMMUNITION, OR OF CARTRIDGES OTHER THAN THOSE FOR WHICH THE FIREARM WAS ORIGINALLY CHAMBERED.

## **! WARNING - LEAD EXPOSURE**



Discharging firearms in poorly ventilated areas, cleaning firearms, or handling ammunition may result in exposure to lead and other substances known to the State of California to cause birth defects, reproductive harm, and other serious physical injury. Have adequate ventilation at all times. Wash hands thoroughly after exposure.

**SHOOTING OR CLEANING FIREARMS  
MAY EXPOSE YOU TO LEAD**

## **! WARNING - AMMUNITION**



*Use only new, factory ammunition of the correct caliber.*

Death, serious injury, and damage can result from the wrong ammunition, bore obstructions, powder overloads or incorrect cartridge components.

Always wear shooting glasses and hearing protection.

**IMPROPER AMMUNITION  
DESTROYS FIREARMS**

## MAGAZINES

Use only GENUINE RUGER® FACTORY magazines designated for your firearm. The use of incorrect magazines in any pistol will result in malfunctions. Check the magazine frequently. The magazine follower must move freely and have adequate tension so that each cartridge is quickly raised to the feeding position. The magazine feed lips should be clean and free of cracks so that cartridges are held in their proper feeding position. If damage is present, the magazine should be replaced.

To load the magazine, press the cartridge base down to depress the follower and slide it under the feed lips, one at a time, until the magazine is full.

Ensure the top cartridge is fully seated against the rear of the magazine. (See Figure 10.)

To unload the magazine, slide each cartridge forward and out of magazine, one at a time, until the magazine is empty.

Figure 10



If the magazine becomes dirty, it should be disassembled and thoroughly cleaned. **Always wear safety glasses when disassembling and reassembling a magazine!** Be sure the magazine is unloaded before disassembly. Use a punch to press in on the magazine spring seat where it protrudes into the hole in the magazine floorplate (see Figure 11). Slide the magazine floorplate toward the front of the magazine. **CAUTION: The magazine spring is under heavy spring tension.** Be careful to prevent the forcible ejection of the magazine spring seat and compressed magazine spring by retaining them with your hand while removing the floorplate (see Figure 12). Withdraw the magazine spring seat, magazine spring, and magazine follower from the magazine body.

Magazine  
Spring Seat



Figure 11

Magazine  
Floorplate



Figure 12

Reassemble the magazine in the reverse order, being careful to insert the spring in the correct orientation (see Figure 13).

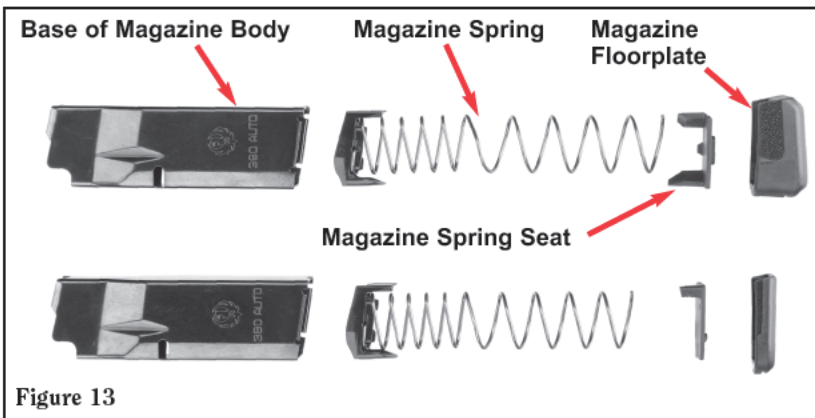

Clean all magazine components with a brush or rag to remove residue. You may use a suitable solvent that will not rust the metal components or adversely affect the magazine body. After cleaning, remove all excess solvent from the magazine components. It is not necessary to lubricate the magazine.

**WARNING:** Penetrating oils and solvents inside a magazine can “kill” or weaken cartridge primers or powder which can result in failures to fire or other possibly dangerous malfunctions, such as leaving a bullet in the bore!

After cleaning and reassembling the magazine, always check to be certain that the magazine follower moves freely and forcefully to the top of the magazine and that no solvent or debris remain. Improper reassembly of the magazine can cause malfunctions.

**DAMAGED, NON-STANDARD OR IMPROPERLY ASSEMBLED MAGAZINES SHOULD NOT BE USED. THEY CAN CAUSE THE PISTOL TO MALFUNCTION.**

**NOTE: Use of Witness Holes**

Witness holes in the side of the magazine body are designed to allow you to quickly and easily view inside the magazine and determine approximately how much ammunition it contains. A standard **RUGER® LCP® MAX** magazine has witness holes located at the five- and 10-round positions. Witness holes are provided for your convenience and you should never rely upon them to determine whether a magazine is loaded or the precise number of rounds it contains currently. The only way to determine for certain whether a magazine is loaded or unloaded is to examine it carefully and count the number of rounds.

## TO LOAD AND FIRE

Before you attempt to load and fire the pistol, first read through this manual completely and be certain you understand the pistol's operation.

Before each firing session, visually inspect the firearm and its magazine to ensure no components are damaged, missing, loose, bent, cracked, chipped, or peened. Ensure the firearm is free of dirt, dust, sand, lint, or environmental debris. The firearm should be clean and lightly lubricated in accordance with the instructions. You should also perform a function check (see page 35) on the unloaded firearm to ensure it operates properly and that all safety devices are in proper working order.

Do not load the pistol until you are ready to use it, and unload it immediately when you are finished.

1. **Be certain the muzzle is pointed in a safe direction.** (See “The Basic Rules of Safe Firearms Handling,” p. 42.)
2. With no magazine inserted in the pistol, pull the slide fully to the rear until the slide stops and lock it open by pushing upward on the slide stop (see Figure 14).



Figure 14

3. Insert a loaded magazine into the grip frame, taking care that the magazine is locked in place by the magazine latch. Slamming the magazine into the grip frame forcibly is not necessary and may cause the slide to close, loading a round into the chamber.
4. Hold the pistol firmly in the shooting hand with your fingers away from the trigger. Keep the pistol pointed in a safe direction. With the other hand, grasp the rear of the slide and pull it fully rearward (see “Slide Retraction Warning,” p. 25). When released, the slide will fly forward to strip the top cartridge from the magazine and chamber it.

**WARNING:** The pistol is now ready for instant use. Be careful!



5. The first shot can be fired by pulling the trigger all the way to the rear. Subsequent shots can be fired one at a time by releasing the trigger then pulling it again until the magazine is empty.
6. At any time, if the pistol is not being fired, keep it pointed in a safe direction (downrange or in a holster).
7. When the last cartridge in the magazine has been fired, the empty magazine will activate the slide stop and hold the slide open. If the slide is shut, the shooter should always assume that there is a cartridge in the chamber!

## TO RELOAD THE PISTOL

1. Firing all cartridges in the magazine and the chamber will cause the slide to automatically lock open. **Keep the pistol pointed in a safe direction.** Press in on the magazine release. The magazine will fall free of the pistol. To avoid damage and debris entering the magazine, do not let it fall to the ground.
2. Insert a loaded magazine. **WARNING: When there is a loaded magazine in place and the pistol is jarred, the slide can fly forward and chamber a cartridge. For this reason and as an essential safety practice, the pistol should always be pointed in a safe direction.**
3. Release the slide by pulling it fully to the rear and release it. A cartridge will be chambered when the slide closes.

**WARNING: The pistol is ready to fire.**

4. When you are finished firing the pistol, unload it completely (see "To Unload" instructions below).

**NOTE:** The pistol may be "topped off" at any time by changing magazines. **Keeping the pistol pointed in a safe direction and keeping fingers away from the trigger,** press the magazine release to remove the partially loaded magazine, being careful not to let it fall to the ground. **REMEMBER that even though the magazine has been removed, a live round remains in the chamber and can be fired.** Next, fully insert a new loaded magazine until it clicks into place.

## TO LOAD AND FIRE (WITHOUT MAGAZINE)

In the event that the magazine is missing or for training purposes (where it is desirable that only one cartridge be loaded and fired at a time for safety), the pistol can be fired with the magazine removed. To do so, keep the pistol pointed in a safe direction, grasp the slide, and retract it fully to the rear. Next, push the slide stop upward to lock the slide to the rear. Insert a single cartridge directly and fully into the chamber. Taking care to keep the pistol pointed in a safe direction and with your finger outside the trigger guard, retract slightly and release the slide. This will cause the slide to move vigorously forward into the firing position. **WARNING: The pistol is ready to fire once the slide moves forward.**

## WARNING - FIRING



The slide automatically opens and closes quickly while firing. Keep face and hands away from the rear of the slide while firing. Hot brass and gasses are ejected from the ejection port and can burn you. Always wear shooting glasses, hat with a brim, and hearing protection.

**SLIDE OPENS FAST -  
HOT BRASS EJECTED**

## WARNING - HANDLING



Do not load the pistol until you are ready to use it, and unload it immediately when you have completed shooting. (See "Unloading Warning" on page 23.)

If dropped or struck, the pistol may fire. Keep chamber empty unless actually firing!

For maximum safety when carrying the pistol with a loaded magazine in place, the chamber should be empty, and the slide should be closed. If placed into a holster, check it to be sure that the slide is not retracted far enough to chamber a cartridge from the magazine.

The user should never depend on any mechanical device to justify careless handling or permitting the pistol to point in an unsafe direction. The shooter should always be alert to the possibility of accidental discharge. **The only absolutely safe pistol is one in which the slide is open, the chamber is empty, and there is no magazine in the firearm.**

**ANY FIREARM  
MAY FIRE IF DROPPED**

## WARNING - UNLOADING



Removing the magazine does not unload the pistol! To unload, first remove the magazine, then pull the slide to the rear, eject the chambered cartridge, and visually inspect the chamber to be sure it is empty. Always point the pistol in a safe direction when loading or unloading.

**REMOVING MAGAZINE  
DOES NOT UNLOAD CHAMBER**

## TO UNLOAD

**WARNING:** This sequence must be followed exactly as outlined. Failure to do so can result in the chamber being unintentionally loaded with a live cartridge! Removing the magazine does not prevent the pistol from firing. The firearm can be fired with the magazine removed if there is a round in the chamber.

1. The muzzle of the pistol must be pointing in a safe direction at all times, and fingers should be outside of the trigger guard.
2. Remove the magazine from the pistol by pushing in on the magazine latch, do not let it fall to the ground. **REMEMBER** that even though the magazine has been removed, a live round may remain in the chamber (see “Unloading Warning,” p. 23).
3. Keeping the pistol pointed in a safe direction, hold the pistol firmly and grasp the slide. Retract the slide to its rearmost position briskly to extract and eject any chambered cartridge. Hold the pistol at an angle where you can clearly see the chamber in the rear of the barrel. Always double check visually that the chamber, breech-face, and the interior of the frame are clear of any live rounds. When the slide is fully retracted, push upward on the slide stop, then allow the slide to move forward until it comes to rest with the rear projection of the slide stop resting in the notch on the lower left side of the slide.
4. At this point you may insert the included cable lock for storage (See “Locking Device Installation Instructions,” p. 9) or, to close the slide, pull the slide to its rearmost position and release it. The slide will snap forward. **Keep fingers out of the ejection port on top of the slide!** Point the empty pistol in a safe direction and dry fire the trigger to release tension on the springs.
5. If the magazine contains cartridges, they can be removed by sliding each cartridge forward and out of the magazine, one at a time, until the magazine is empty.

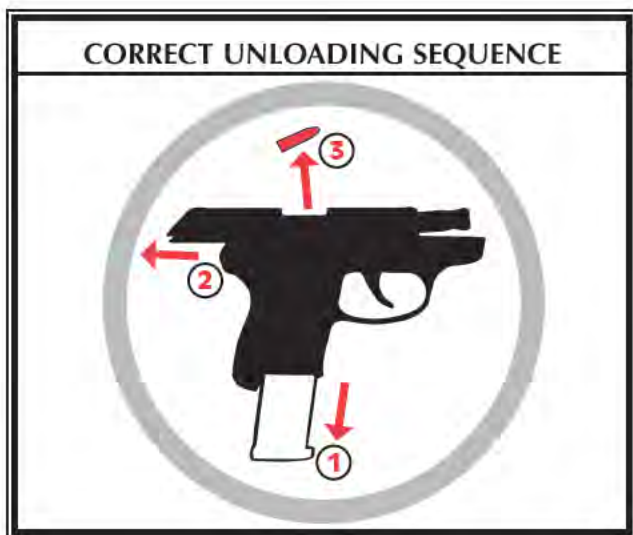





## WARNING - SLIDE RETRACTION



The slide should always be pulled rearward (“retracted”) while ensuring the pistol is pointed in a safe direction. **Always keep fingers away from the trigger!**



**Never put any part of your hands or body over the muzzle while retracting the slide** for loading, unloading, inspection or clearing a malfunction.

**KEEP HANDS  
AWAY FROM MUZZLE AND  
FINGER OFF TRIGGER**

## TO EXTRACT AND EJECT A CHAMBERED CARTRIDGE

If the shooter wishes to eject a chambered cartridge manually, follow the procedure “To Unload,” p. 24. When the slide is operated by hand, pull vigorously back on the slide to ensure the cartridge is extracted and ejected from the chamber. Otherwise, the cartridge may drop on top of the magazine or remain held to the breech-face by the extractor. Then, when the slide goes forward, the cartridge will be chambered again! Remember — always remove the magazine before clearing the chamber and visually check the chamber and the breech-face to ensure that no cartridges remain in the firearm.

## TO CLEAR A MALFUNCTION ("JAM" or "MISFIRE")

1. Be certain the muzzle is continually pointed in a safe direction. Keep fingers out of the trigger guard.
2. If the misfire is the result of a cartridge not firing or unusual report (either louder or quieter than normal), keep the pistol pointed in a safe direction for 30 seconds prior to ejecting the chambered round or retracting the slide.
3. If possible, remove the magazine. It may be necessary to manually remove a jammed cartridge that has only been partially stripped from the magazine. If so, use extreme care.
4. Lock the slide open with the slide stop before attempting to clear the jam. Drawing the slide fully to the rear may extract and eject the cartridge or casing. Keep your face away from the ejection port during this operation. When attempting to clear a jam, use only wood "tools" so that the cartridge will not be damaged or the primer ignited. A 3/16" wooden dowel with a point on one end is useful.
5. Visually check to make sure that all cartridges have been removed from the pistol. Safely dispose of any cartridges involved in a malfunction incident. Do not use damaged ammunition in any firearm.
6. Using a cleaning rod, inspect the bore and chamber to ensure that they are not obstructed. **Failure to detect and correctly remove a bore obstruction can result in serious injury!**

 <b>WARNING - MALFUNCTIONS</b>	
	<p>Any autoloading pistol may occasionally malfunction. If a cartridge hangs up, jams or binds when being chambered, do not attempt to force it into the chamber by pushing or striking the slide. Carefully remove it.</p> <p>Most failures of a cartridge to feed or to chamber properly are caused by a damaged magazine, incorrect firearm handling, insufficient lubrication or improper ammunition.</p> <p>Whatever the cause, the user of the pistol must, above all, recognize that any cartridge jam can result in a potentially very dangerous situation of a cartridge discharging before it is properly chambered. If this happens, the cartridge case may rupture and its fragments fly out of the ejection port of the pistol with sufficient force to cause serious injury. <b>Always wear shooting glasses!</b></p>
	<b>HITTING PRIMER CAN BURST CARTRIDGE</b>

## TO MINIMIZE MALFUNCTIONS ("JAMS" or "MISFIRES")

Alterations to the pistol or use of non-Ruger magazines and accessories may cause malfunctions. See "Warning – Alterations" on p. 11.

1. If it appears that the jam was caused by the type of ammunition being used, try another brand, type or lot number. Remember — use only factory ammunition of the correct caliber.
2. Frequently clean and lubricate the pistol according to the instructions on p. 34. Use a bristle brush and solvent to remove fouling, paying particular attention to the breech-face, extractor, and chamber. Be careful not to over-lubricate.
3. Frequently inspect the firearm for wear or damage according to the instructions on p. 31.
4. Clean and inspect the magazine according to the instructions on p. 19 or try a different GENUINE RUGER® FACTORY magazine.
5. Make sure you are following the correct loading and firing sequence as described in this manual. Try firing the pistol again using a firm two-handed grip.
6. If none of the above steps are effective, contact the Ruger Customer Service Department for additional assistance. See "Service and Parts Policy," p. 37.

## DISASSEMBLY

**Be sure the pistol is unloaded!**

An on-line video demonstrating the disassembly and reassembly of the **RUGER® LCP® MAX** pistol can be viewed by going to [Ruger.com/TechTip](http://Ruger.com/TechTip).

 <b>WARNING – DISASSEMBLY</b>	
	<p>Always unload a firearm before cleaning, lubrication, disassembly or assembly.</p>
	<p><b>UNLOAD BEFORE DISASSEMBLY</b></p>

1. **Keep pistol pointed in a safe direction.** Press the magazine latch and withdraw the magazine from butt of pistol (see Figure 15).



2. Pull slide to the rear and lock in the open position by pushing upward on the slide stop. (see Figure 16).



3. Inspect the chamber and verify that it is empty (see Figure 17).





4. Retract the slide slightly and release it (see Figure 18). This will disengage the slide stop and allow the slide to move fully forward.



5. Pry loose the takedown pin using a screwdriver or other flat, blunt tool (see Figure 19).



6. Remove the takedown pin completely (see Figure 20).



7. Move the slide assembly forward and separate it from the grip frame (see Figure 21).



8. Compress the recoil spring assembly slightly to disengage it from its seat against the barrel lug, and remove it completely (see Figure 22).



9. Remove the barrel. It will be necessary to move the barrel forward slightly and then down and back to extract it from the slide (see Figure 23).



10. The pistol is now disassembled for cleaning (see Figure 24).



**NOTE:** Do not attempt further disassembly of your firearm. The firearm can now be cleaned and lubricated. There are no user serviceable parts below this level. If further disassembly is required, contact Ruger Customer Service.

# INSPECTION, CLEANING and LUBRICATION

## Make Sure the Firearm is Unloaded!

Your new **RUGER® LCP® MAX** pistol arrived from the factory properly lubricated and ready to fire. You do not need to clean the pistol before using it for the first time. **BEFORE CLEANING, FIRST, BE SURE THERE IS NO AMMUNITION IN THE CHAMBER OR THE MAGAZINE AND KEEP THE PISTOL POINTED IN A SAFE DIRECTION!** (See “Unloading Warning,” p. 23)

Periodic inspection of any firearm is important to ensuring its safe operation. It is important to clean and inspect your firearm after each range session or whenever the pistol has been exposed to sand, dust, moisture, humidity, or other adverse conditions. Proper maintenance increases the longevity of your firearm and will allow early detection of worn or broken parts.

Visually inspect the firearm and its magazine to ensure no components are damaged, missing, loose, bent, cracked, chipped, or peened. If you observe excessive wear, you should stop using your pistol and contact customer service or a trained certified gunsmith to evaluate its condition and replace any worn parts if necessary.

**NOTE:** An on-line video demonstrating the cleaning of the **RUGER® LCP® MAX™** pistol can be viewed by going to [Ruger.com/TechTips](http://Ruger.com/TechTips).

To clean the pistol, proceed as follows:

1. Disassemble (fieldstrip) the pistol to the extent described on pages 27 - 30.
2. Using a cleaning rod, run a properly sized, solvent-wetted patch through the bore several times. Then attach a solvent-wetted bristle brush to a cleaning rod and run it back and forth the full length of the bore as many times as necessary to remove grease and dirt from the bore and chamber. Clean the bore with dry patches and examine. Bore fouling can contribute to reduced accuracy and grease accumulation in the chamber can interfere with proper feeding of cartridges from the magazine.
3. Using solvent on a clean patch or bristle brush, remove powder residue from all components of the pistol. After cleaning, run a dry patch through the bore, then follow with a patch that is very lightly oiled. Wipe all surfaces clean with cloth, then wipe all surfaces with a patch or cloth that has been very lightly oiled.
4. **NOTE:** Only a light application of oil is needed to provide adequate lubrication of moving parts and to prevent rust. Excess accumulations of oil tend to attract particles of dust and dirt and may congeal in cold weather, which can interfere with the safe and reliable function of the pistol.
5. Before firing, remove all oil and grease from the bore.



## WARNING - LUBRICATION



Firing a pistol with oil, grease or any other material even partially obstructing the bore may result in damage to the pistol and serious injury to the shooter and those nearby. Do not spray or apply lubricants directly on ammunition. If the powder of a cartridge is affected by the lubricant, it may not be ignited, but the primer firing may push the bullet into the bore where it may be lodged. **Firing a subsequent bullet into the obstructed bore may damage the pistol and cause serious injury or death to the shooter and those nearby.** Use lubricants properly. You are responsible for the proper care and maintenance of your firearms.

**IMPROPER LUBRICATION  
DESTROYS FIREARMS**

## REASSEMBLY

1. **Be certain the chamber and magazine are empty.**
2. With slide held upside down, replace the barrel and push it rearward into its locked position. (See Figure 25.)



Figure 25

3. With the slide and barrel upside down, place the guide rod/recoil spring assembly into position. The rear end of the guide rod seats against the barrel lug. (See Figure 26.)

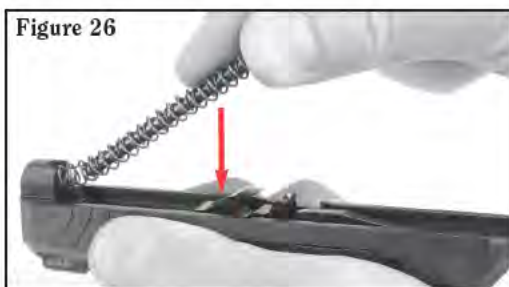

Figure 26



4. Reinstall the slide onto the frame (see Figure 27) and place the slide in its “closed” position, as if the pistol were fully assembled.

**NOTE:** The slide should never be installed on the frame without first installing the barrel and guide rod assembly into the slide.



5. Insert the takedown pin into the frame at a downward angle (about 45°) until its tip pushes down its retaining spring (see Figure 28). Then rotate the pin downward until it is aligned with its hole and insert it fully into the pistol frame.
6. Replace the empty magazine in the frame through the butt of pistol.



## CHECK YOUR PISTOL'S FUNCTION

Periodic inspection of any firearm is important to ensuring its safe operation. It is important to clean and inspect your firearm after each range session or whenever the firearm has been exposed to sand, dust, moisture, humidity, or other adverse conditions. Proper maintenance increases the longevity of your firearm and will allow early detection of worn or broken parts.

Prior to each use, visually inspect the firearm to ensure no components are damaged, missing, loose, bent, cracked, chipped, or peened. If you observe excessive wear, you should stop using your pistol and contact customer service or a trained certified gunsmith to evaluate its condition and replace any worn parts if necessary.

After any disassembly and reassembly, it is important to verify that the action is working correctly before any live firing is attempted.

**FIRST, BE SURE THERE IS NO AMMUNITION IN THE CHAMBER OR THE MAGAZINE AND KEEP THE PISTOL POINTED IN A SAFE DIRECTION!**

a. CHECK THE FUNCTION OF THE SLIDE AND SLIDE STOP:

- With the magazine removed from the pistol and the slide forward, pull the slide fully to the rear and let it move forward quickly two times.
- Insert an **EMPTY** magazine into the pistol. The magazine should latch into place securely. Briskly pull the slide fully to the rear and release it. The slide should move forward a fraction of an inch and remain open, held in place by the slide stop.
- Depress the magazine latch and remove the empty magazine. The slide should remain held open by the slide stop.
- With the magazine removed from the pistol, fully retract the slide and release it. The slide stop should disengage and the slide should fully close. The hammer should not fall.
- The slide should move freely without binding and close completely under the force of the recoil spring.

b. CHECK THE FUNCTION OF THE TRIGGER:

- With the magazine out of the pistol, cycle the slide open and closed to ensure the hammer is cocked. The end of the hammer is visible through the opening at the rear of the slide when cocked.
- With the magazine out of the pistol and the firearm pointed in a safe direction, pull the trigger fully to the rear to “dry fire” the pistol. The trigger should move rearward fully and the hammer should fall.
- Keeping the trigger pulled to the rear and no magazine in the firearm, cycle the slide to reset the hammer. Release the trigger. The trigger should move forward and you will hear/feel the trigger reset. The hammer should not fall and will be visible at the rear of the slide.

**If any of the above function checks fail or if you are uncertain, please consult a competent gunsmith or contact Ruger Customer Service at 336-949-5200 for further firearm inspection **before using the firearm.****

## SIGHT ADJUSTMENT

The **RUGER® LCP® MAX™** pistol is equipped with a rear sight which is adjustable for windage only.

**To adjust for windage**, the rear sight can be drifted laterally in its dovetail on the top of the slide by tapping it with a wooden or plastic headed hammer or similar implement. Move the rear sight in the direction you want the shot to move on the target.

Your **RUGER® LCP® MAX™** pistol may come equipped with self illuminating sights containing a small quantity of radioactive Hydrogen 3 (H3), commonly known as tritium, in gaseous form. Because tritium is a radioactive element, sights containing tritium will naturally dim over time. Sights containing tritium are marked "H3."



**WARNING:** Tritium is non hazardous so long as the tritium vials are unbroken. No attempt should be made to disassemble the sights or otherwise break the vial containing tritium. If you come into contact with a broken or leaking tritium vial, you should wash your hands carefully with soap and water and avoid ingesting or inhaling the gases. Additionally, great care should be taken to avoid flame in the presence of a broken or leaking tritium vial and you should not handle the damaged sights if you have open cuts or abrasions. Only handle sights with damaged or leaking tritium sights in a well ventilated area and avoid inhaling air near the damaged vial

## STORAGE

FIREARMS SHOULD NOT BE STORED LOADED!

**USE THE LOCKING DEVICE SUPPLIED WITH THE PISTOL TO  
RENDER IT INOPERATIVE FOR SAFE STORAGE.  
(SEE PAGE 9)**

*Do not* keep the pistol stored in a leather holster or case. Leather attracts moisture, even though the holster or case may appear to be perfectly dry.

 <b>WARNING – STORAGE</b>	
	<ul style="list-style-type: none"><li>• Never place or store any firearm in such a manner that it may be dislodged. Firearms should always be stored securely and unloaded, away from children and careless adults.</li><li>• Use the locking device supplied with the pistol for storage. The use of a locking device or safety lock is only one aspect of responsible firearms storage.</li><li>• For increased safety, firearms should be stored unloaded in a location that is both separate from their ammunition and inaccessible to children and any other unauthorized person.</li></ul>
<b>STORE SECURELY &amp; UNLOADED</b>	

## SERVICE AND PARTS POLICY

If you have any questions with regard to the performance of your **RUGER® LCP® MAX™** pistol please contact our Customer Service online at [Ruger.com](http://Ruger.com) or call the Customer Service Dept. at 336-949-5200. Fully describe all circumstances and conditions involved. If you should return your pistol to the factory for repair, or order parts for it, please comply with the following suggestions for prompt service:



**WARNING—BEFORE SHIPPING ANY FIREARM, BE ABSOLUTELY CERTAIN THAT THE FIREARM AND ITS MAGAZINE ARE UNLOADED. DO NOT SHIP CARTRIDGES WITH A FIREARM.**

### SHIPPING FIREARMS FOR REPAIR:

**NOTE:** You must obtain a Repair Authorization Number before returning your firearm. An authorization number can be obtained by contacting Customer Service online at [Ruger.com](http://Ruger.com) or calling the Customer Service Department at 336-949-5200. Firearms should be sent prepaid. We will not accept collect shipments. Any **RUGER® LCP® MAX™** pistol returned to the factory for repair should be sent to: Sturm, Ruger & Company, Inc., Customer Service Department, 271 Cardwell Road, Mayodan, NC 27027.

The Federal Gun Control Act, as well as the laws of most states and localities, do not prohibit an individual (who is not otherwise barred from purchasing or possessing a firearm) from shipping a firearm directly to the manufacturer for repair. However, before you ship your firearm to us, be certain that your state or locality does not have a law or regulation which will prohibit you from receiving the firearm (or any included magazines) from us after it has been repaired. If such receipt is prohibited, please have a federally licensed firearms dealer ship the firearm to us. If your firearm is sent to us by a dealer, it will be returned to that dealer after being repaired. If a handgun (pistol or revolver) is shipped by an individual who does not hold a Federal Firearms License, it must be shipped for overnight delivery via U.P.S., Federal Express, or other, similar private overnight service. **NOTE:** Handguns may not be shipped via U.S. Mail. Persons who do not hold a Federal Firearms License are prohibited by Federal law from shipping a handgun by Mail. Handguns mailed in violation of the law may be impounded or confiscated by the Post Office and the non-FFL may be subject to prosecution.

Please do not include holsters, custom grip panels, or accessories with a firearm being shipped to the factory for service. **DO NOT SEND FIREARM BOXES OR LITERATURE THAT YOU CONSIDER TO BE COLLECTOR'S ITEMS – THESE ARE INVARIABLY DAMAGED OR DESTROYED IN SHIPMENT.** Always insure your shipment.

Enclose a letter which includes your name, address, telephone number, firearm serial number and model, and repair authorization number. Describe in detail the trouble you have experienced with your firearm, or the work you wish to have done. Merely stating that the firearm “needs repair” is inadequate information. Please enclose copies of any previous correspondence.



All work performed is subject to a minimum labor charge and charges for shipping and handling. Most models can be reblued, but custom gunsmithing service or nonstandard alterations are NOT AVAILABLE from Ruger Customer Service Departments. Please contact the Customer Service Department for pricing information. In states that have a magazine capacity limitation, DO NOT RETURN so-called "high capacity" magazines as Ruger may not be able to return the magazine to you.

 <b>WARNING – PARTS PURCHASERS</b>	
	<ul style="list-style-type: none"><li>• It is the purchaser's responsibility to be absolutely certain that any parts ordered from the factory are correctly fitted and installed.</li><li>• Firearms are complicated mechanisms and <b>IMPROPER FITTING OF PARTS MAY RESULT IN A DANGEROUS MALFUNCTION, DAMAGE TO THE FIREARM, AND SERIOUS INJURY TO THE SHOOTER AND OTHER PERSONS.</b></li><li>• The purchaser and installer of parts must accept full responsibility for the correct adjustment and functioning of the firearm after such installation.</li></ul>
<b>PARTS MUST FIT CORRECTLY</b>	

## ORDERING PARTS

Please contact the Prescott, Arizona Customer Service Department for parts availability and current prices. All parts orders for the **RUGER® LCP® MAX™** pistols should be sent to: Sturm, Ruger & Company, Inc., Customer Service Department, 271 Cardwell Road, Mayodan, NC 27027, 336-949-5200. We cannot comply with open account or C.O.D. requests. Payment in full via credit card (Visa, MasterCard, or Discover only), money order or certified bank check (no personal checks or cash, please) is required before any service will be performed. Please provide your credit card number, your name as it appears on the credit card, the expiration date and the 3-digit security code. All parts orders are subject to a minimum charge and charges for shipping and handling. Order parts by **Part Name and specify the model and entire serial number** of the firearm for which the parts are being ordered. There is a minimum labor charge plus a shipping and handling charge if the parts are factory fit. All factory fit parts are fit on an exchange basis only. We will not return the replaced parts. Please contact the Customer Service Department for pricing information.

Because it is a serial numbered component, the **RUGER® LCP® MAX™** pistol frame insert is defined as a "firearm" by Federal law and is not sold as a separate component.

\*Parts designated by an asterisk must be factory fit. These parts are fit on an exchange basis only. We will not return the replaced parts. We will not return any part that is broken, malfunctioning, badly worn or has been modified. See "Warning - Parts Purchasers," above.



**WARNING: A firearm containing broken, malfunctioning or badly worn parts should not be fired!**

# RUGER® LCP® MAX

## PARTS LIST

Design, prices and specifications subject to change without notice.  
**SPECIFY MODEL, CALIBER, AND SERIAL NO. WHEN ORDERING**  
(See Exploded View on Page 41)

Key No.	Part Name
1	Grip Frame
2	Magazine Latch
3	Magazine Latch Spring
* 4	Slide
5	Rear Sight
6	Hammer
7	Hammer Pin
8	Hammer Spring
9	Hammer/Sear Pivot Pin, 2 Req'd
10	Hammer Spring Seat Pin
11	Hammer Spring Cap
12	Extractor
13	Firing Pin/Extractor Retaining Pin, 2 Req'd
14	Extractor Spring
15	Front Sight
16	Firing Pin
17	Firing Pin Spring
† 18	Frame Insert
19	Outer Trigger
20	Inner/Outer Trigger Pin
21	Inner Trigger
22	Inner Trigger Spring
23	Trigger Pivot Pin
24	Trigger Pivot

† The Frame Insert is a serial-numbered component and is defined as a “firearm” by Federal Law and is not sold as a separate component.

\* PARTS SO MARKED MUST BE FACTORY FIT

<b>Key No.</b>	<b>Part Name</b>
25	Trigger Spring
* 26	Trigger Bar
* 27	Sear
28	Sear Spring
29	Takedown Pin Detent
30	Slide Stop
31	Guide Rod
32	Inner Recoil Spring
33	Outer Recoil Spring
* 34	Barrel
35	Takedown Pin
36	Front Frame Pin
37	Magazine Assembly, 12-rd
38	Magazine Assembly, 10-rd
39	Pinky Extension Floorplate

\* PARTS SO MARKED MUST BE FACTORY FIT



# RUGER® LCP® MAX

## EXPLODED VIEW

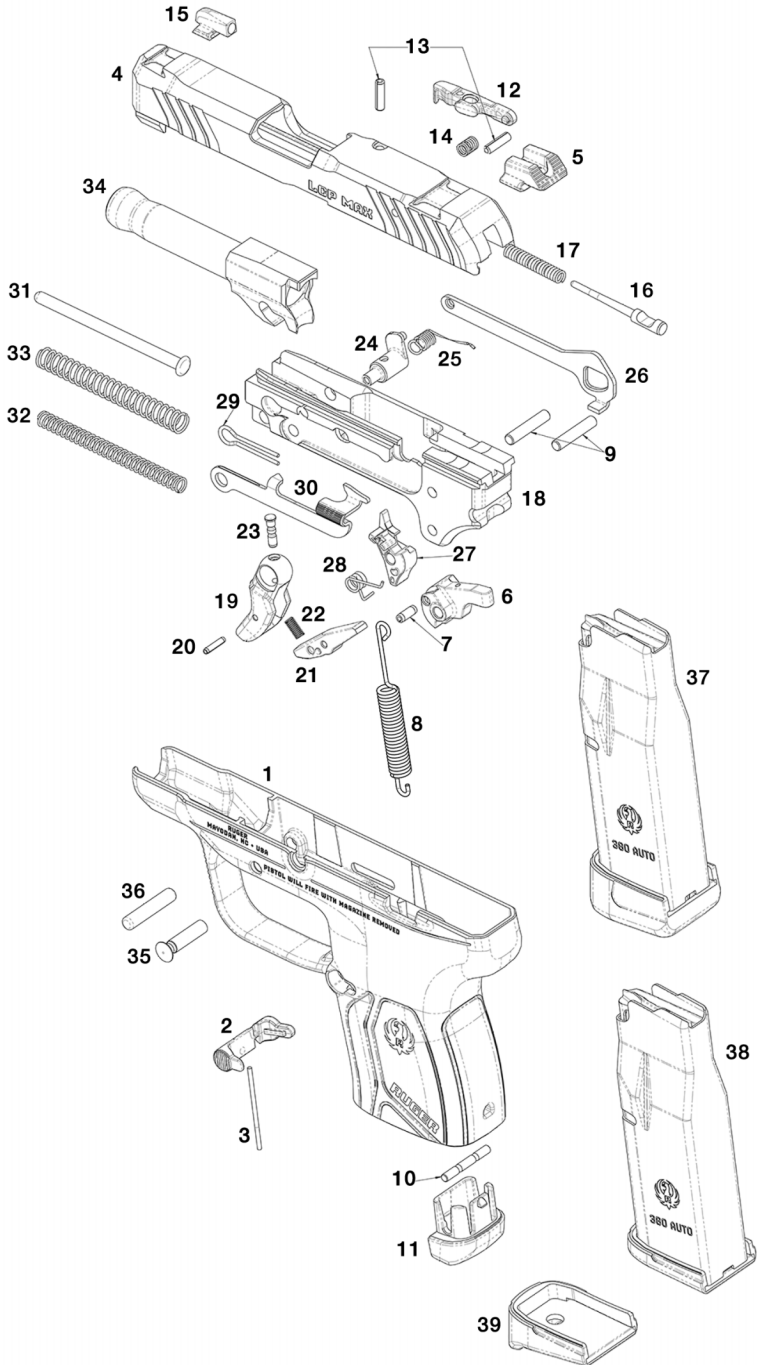

## THE BASIC RULES OF SAFE FIREARMS HANDLING

We believe that Americans have a right to purchase and use firearms for lawful purposes. The private ownership of firearms in America is traditional, but that ownership imposes the responsibility on the gun owner to use his firearms in a way which will ensure his own safety and that of others. When firearms are used in a safe and responsible manner, they are a great source of pleasure and satisfaction, and represent a fundamental part of our personal liberty.

Firearms do not cause accidents! Firearms accidents are almost always found to have been the result of carelessness or ignorance on the part of the shooter of the basic rules of safe gun handling.

The following rules must be observed by gun users at all times. Safe gun handling is not just desirable, it is absolutely essential to your safety, the safety of others, and the continuation of gun ownership and sport shooting as we know it today.

### 1. LEARN THE MECHANICAL AND HANDLING CHARACTERISTICS OF THE FIREARM YOU ARE USING.



Not all firearms are the same. The method of carrying and handling firearms varies in accordance with the mechanical provisions for avoiding accidental discharge and the various proper procedures for loading and unloading. No person should handle any firearm without first having thoroughly familiarized himself with the particular type of firearms he is using, and with safe gun handling in general.

### 2. ALWAYS KEEP THE MUZZLE POINTED IN A SAFE DIRECTION.



Be sure of the bullet stop behind your target, even when dry-firing. Never let the muzzle of a firearm point at any part of your body or at another person. This is particularly important when loading or unloading a firearm. In the event of an accidental discharge, no injury can occur as long as the muzzle is pointing in safe direction. A safe direction means a direction that will not permit a discharged bullet to strike a person, or to strike an object from which the bullet may ricochet.

A safe direction must take into account the fact that a bullet may penetrate a wall, ceiling, floor, window, etc., and strike a person or damage property. Make it a habit to know exactly where the muzzle of your gun is pointing whenever you handle it, and be sure that you are always in control of the direction in which the muzzle is pointing, even if you fall or stumble. Keep your finger off the trigger until you are ready to shoot.

### 3. FIREARMS SHOULD BE UNLOADED WHEN NOT IN USE.



Firearms should be loaded only when you are in the field or on the target range or shooting area, ready to shoot. Firearms and ammunition should be securely locked in safes, racks or cabinets, or by using the locking device supplied with the firearm when not in use. Ammunition should be safely stored separate from firearms. Store your firearms out of sight of visitors and children. It is the gun owner's responsibility to be certain that children and persons unfamiliar with firearms cannot gain access to firearms, ammunition, or components.

### 4. BE SURE THE BARREL IS CLEAR OF OBSTRUCTIONS BEFORE SHOOTING.

Even a bit of mud, snow or excess lubricating oil or grease in the bore may cause the barrel to bulge, or even burst on firing, and can cause injury to the shooter and bystanders. Be sure that you are using ammunition of the proper caliber and loading for the gun you are using. If the report or recoil on firing seems weak, or doesn't seem quite right, **CEASE FIRING IMMEDIATELY**, unload your firearm, and check to be sure that no obstruction has become lodged in the barrel. Never try to shoot an obstruction out!





### **5. BE SURE OF YOUR TARGET BEFORE YOU SHOOT.**

Don't shoot unless you know exactly where your bullet is going to strike. Be sure of the bullet stop behind your target, even when dry-firing with an unloaded gun. If you are in the field hunting, do not fire at a movement or noise. Take the time to be absolutely certain of your target before you pull the trigger.

### **6. WEAR SHOOTING GLASSES AND HEARING PROTECTION WHEN YOU SHOOT.**

All shooters should wear protective shooting glasses and adequate hearing protection when shooting. Exposure to shooting noise can damage hearing, and wearing adequate eye protection when shooting is essential.



### **7. NEVER CLIMB A TREE OR FENCE WITH A LOADED FIREARM.**

Put the firearm down carefully before climbing a fence, and unload it before climbing or descending a tree or jumping over a ditch or other obstruction. Never pull or push a loaded firearm toward yourself or another person. When in doubt, or whenever you are about to do anything awkward, unload your gun!



## 8. DON'T SHOOT AT A HARD SURFACE OR AT WATER.

Bullets can glance off many surfaces like rocks or the surface of water and travel in unpredictable directions with considerable velocity.



## 9. NEVER TRANSPORT A LOADED FIREARM.

Firearms should always be unloaded before being moved or placed in a vehicle. A suitable carrying case or scabbard should be used to carry an unloaded firearm to and from the shooting area.

## 10. AVOID ALCOHOLIC BEVERAGES WHEN SHOOTING.

Don't drink until the day's shooting is over. Handling firearms while under the influence of alcohol in any form, or medications that could affect your judgement or coordination, constitutes a criminal disregard for the safety of others.





## A BRIEF ACCOUNT OF AN EXTRAORDINARY ACHIEVEMENT: RUGER® FIREARMS

Sturm, Ruger & Company, Inc., had its beginning in a small machine shop occupying a rented frame building in Southport, Connecticut. In January, 1949, with an initial investment of only \$50,000 and an idea, William B. Ruger and Alexander M. Sturm started production of a .22 caliber autoloading pistol—a design which was so successful that it became the cornerstone upon which one of the most comprehensive lines of sporting firearms ever made in America was established. After Alex Sturm's death in 1951, William B. Ruger continued to direct the Company until his death in 2002. William B. Ruger, Jr. continued to provide guidance, which helped make this Company a sound and successful enterprise, until his retirement in 2006. The Company has continued to prosper, under new management and guidance from our Board, with new products and fresh perspectives.

Ruger, in this relatively short time, has established itself as a leading small arms design organization, developing a unique and broad line of fine quality sporting, military and police firearms to become one of the world's most famous producers of revolvers, pistols, rifles and shotguns. Since 1949, Ruger craftsmen have built many millions of firearms.

During its five decades of growth and progress under the leadership of William B. Ruger, the Company developed a business philosophy and implemented policies which represent a constructive influence in the life of modern America. From the beginning, Ruger played a positive role in conservation efforts and has supported the interests of shooters through such groups as the National Rifle Association, National Shooting Sports Foundation, and many regional sportsmen's organizations.

The Company has always endeavored to market its firearms for constructive and recreational purposes, to emphasize the traditional and responsible aspects of shooting, to render meaningful public services, and to encourage shooters in constructive, responsible, and safe participation in the shooting sports. Its motto, "Arms Makers For Responsible Citizens®," exemplifies this Company philosophy.

Today, Ruger® is particularly mindful of those elements which have contributed to the creation of its success, and extends heartfelt thanks to its many loyal employees and customers.

The firearms catalog, and instruction manuals for all Ruger® firearms, can be downloaded from our website at:

**Ruger.com**

# NOTES

## WHY NO WARRANTY CARD HAS BEEN PACKED WITH THIS NEW RUGER® FIREARM

The Magnuson-Moss Act (Public Law 93-637) does not require any seller or manufacturer of a consumer product to give a written warranty. It does provide that if a written warranty is given, it must be designated as "limited" or as "full" and sets minimum standards for a "full" warranty. Sturm, Ruger & Company, Inc. has elected not to provide any written warranty, either "limited" or "full", rather than to attempt to comply with the provisions of the Magnuson-Moss Act and the regulations issued thereunder. There are certain implied warranties under state law with respect to sales of consumer goods. As the extent and interpretation of these implied warranties varies from state to state, you should refer to your state statutes. Sturm, Ruger & Company wishes to assure its customers of its continued interest in providing service to owners of Ruger® firearms.



**STURM, RUGER & COMPANY, INC.**  
271 Cardwell Road  
Mayodan, North Carolina 27027 U.S.A.  
Ruger.com

**Arms Makers For Responsible Citizens®**

**A COPY OF THE INSTRUCTION MANUAL FOR ANY RUGER®  
FIREARM IS AVAILABLE FROM THE FACTORY FREE ON REQUEST, OR IT MAY BE  
DOWNLOADED FROM OUR WEBSITE AT RUGER.COM.  
THESE INSTRUCTION MANUALS CONTAIN IMPORTANT  
WARNINGS WHICH MUST BE UNDERSTOOD  
BEFORE USING THESE FIREARMS.**

**The Following are Sturm, Ruger & Co., Inc. Trademarks:** "All-Weather," "Bisley," "Gold Label," "I'm a Ruger American," "LC6," "LCR-357," "LC380CA," "Mark II," "Mark III," "Mark IV," "MAX-9," "Model 96," "P345," "P345D," "P345PR," "P85," "P89," "P90," "P91," "P93," "P94," "P95," "P97," "PC Carbine," "R.I.O.S.," "Ruger-57," "Ruger Marksman Adjustable," "Ruger 77/50," "Ruger 10/17," "Security-Six," "Service-Six," "77/357," "Single-Seven," "Speed-Six," "SR45," "SR-556C," "SR-556VT," "Super Bearcat," "Target Grey," "10/22-FS," "This is Ruger. This is America," "Tri-Flex," "22 Charger," "22/45," "22/45 RP," and "Your Next Handgun."

**The Following are Registered U.S. Trademarks Belonging to Sturm, Ruger & Co., Inc.:** "AC-556," "AR-556," "Arms Makers For Responsible Citizens," "Bearcat," "Blackhawk," "BX-15," "BX-25," "BX-Trigger," Eagle - solid logo design, Eagle Hard "R" logo holding gun, Eagle "R" - soft "R" & hard "R" logo design, Eagle w/"SR", Eagle w/soft "R" linear logo design, Eagle w/hard "R" linear logo design, Eagle w/soft "R" stacked logo design, Eagle w/hard "R" stacked logo design, Eagle w/soft "R" linear logo design & "Rugged, Reliable Firearms" below logo, Eagle w/hard "R" linear logo design & "Rugged, Reliable Firearms" below logo, "EC9s," "Elite 452," "GP100," "Hawkeye," "It's Mine and It's American," "It's Mine. And It's American," "LC380," "LC9," "LC9s," "LC9s Pro," "LCP," "LCR," "LCRx," "M77," "Match Champion," "Mini-14," "Mini Thirty," "9E," "Old Army," "Power Bedding," "Redhawk," "RUGER," "Ruger American," "Ruger American Pistol," "Ruger American Pistol" flag design, "Ruger American Rifle," "Ruger American Rimfire," "Ruger Custom Shop," "Ruger Hunting" - phrase & logo design, "Ruger Precision," "Ruger Precision Rifle" - phrase & logo design, "Ruger 77/17," "Ruger 77/22," "Ruger 77/44," "Ruger SP101," "Ruger 10/22 Takedown" phrase & logo design, "Ruger Titanium," "Ruger 22/45 Lite," "Ruger Vaquero," "Rugged, Reliable Firearms," "Security-9," "Silent-SR," "Single-Nine," "Single-Six," "Single-Ten," the "SR" Design, "SR9," "SR9c," "SR40," "SR40c," "SR-22," "SR22," "SR-556," "SR-556 Takedown," "SR-762," "SR1911," "Super Redhawk Alaskan," "10/22," & "Wrangler."