

**ELECTRO-OPTICS**



*SIERRA6BDX™ Shown*

**SIERRA**™

RIFLESCOPE WITH BALLISTIC DATA XCHANGE™

**OWNERS MANUAL**

**SIG SAUER**

## TABLE OF CONTENTS

Introduction.....	3
Features .....	3
Contents .....	4
Product Identification .....	4
Operation .....	6
Illumination Brightness level.....	7
Sight Adjustments.....	8
FAQ .....	24
Maintenance.....	25
Troubleshooting .....	25
SIG SAUER® Electro-Optics Infinite Guarantee™ .....	26
SIG SAUER Electronic & Tritium Component Limited 5-Year Warranty ..	27

Manual covers the following products:

- SOSBDX62111 SIERRA6BDX 2-12x40mm
- SOSBDX63111 SIERRA6BDX 3-18x44mm
- SOSBDX65111 SIERRA6BDX 5-30x56mm
- SOSBDX32111 SIERRA3BDX 2.5-8x32mm
- SOSBDX33111 SIERRA3BDX 3.5-10x42mm
- SOSBDX34111 SIERRA3BDX 4.5-14x44mm
- SOSBDX34112 SIERRA3BDX 4.5-14x50mm
- SOSBDX36111 SIERRA3BDX 6.5-20x52mm

Please visit [sigsauer.com](http://sigsauer.com) for Owners Manual downloads.

## INTRODUCTION

SIG SAUER demands the most of their products. The SIERRA™ series BDX® riflescope is no exception. Offering maximum light transmission and optical clarity, the SIERRA riflescope is built to withstand the rigors that modern shooters and hunters require.

## SIERRA™ FEATURES

- **BDX Ballistic Data Xchange.** A rangefinder and riflescope system that uses ballistics, environmental conditions and Bluetooth® to illuminate the exact holdover dot.
- **MOTAC™** (Motion Activated Illumination).
- **Digital Focal Plane™**, combining Second Focal Plane stadias, with an OLED illuminated ballistic holdover dot that automatically scales with zoom to subtend on target at any magnification level.
- **SPECTRACOAT™** ultra-wide broadband, anti-reflection lens coatings.
- **KinETHIC™** kinetic energy transfer indicator. KinETHIC indicates when energy on target drops below a threshold that can be set by the hunter using the SIG BDX App.
- **LEVELPLEX®** Digital Anti-Cant System.
- Dependable, waterproof (IPX-7 rated for complete immersion up to 1 meter) and fog-proof
- The SIERRA is covered by SIG SAUER's **INFINITE Guarantee™** and Electronics Limited Warranty, see website for full details.

**CONTENTS:**

- Rifle scope
- Two (2) CR2032 Batteries
- Quick Start Guide

**PRODUCT IDENTIFICATION**

- A** Objective Lens
- B** Main Tube
- C** Battery Port Cover
- D** Illumination Power Selector Ring/ Parallax Adjustment Ring (select models)
- E** Elevation Dial
- F** Windage Dial
- G** Power Selector Ring
- H** Bluetooth® Communication LED Indicator
- I** Diopter Adjustment Ring
- J** Ocular Lens

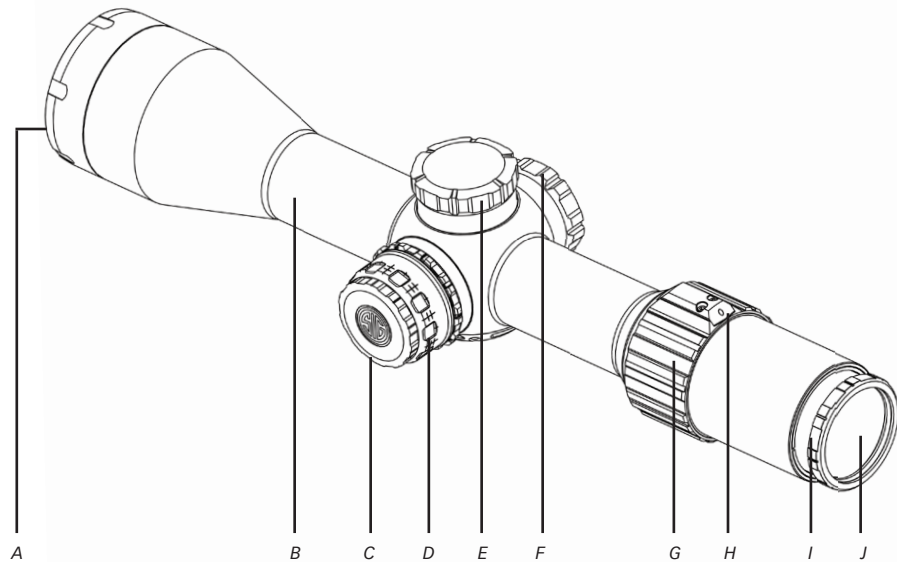

**! WARNING**

Before working on your SIERRA™ riflescope always ensure that the firearm is unloaded with the safety on.

**OPERATION****Installing the battery**

SIERRA riflescopes require two (2) CR2032 batteries. To install the battery, loosen the battery port cover on the left side of the riflescope turret. Place both batteries into the battery port with the plus side facing inward. Replace the battery port cover and tighten it down. Ensure that the cover is finger tight.

**ILLUMINATION BRIGHTNESS LEVEL**

- Select the illumination brightness level that suits your conditions the best
- Higher power settings, indicated by larger numbers, are better suited for brighter conditions
- Lower power settings, indicated by smaller numbers, are better suited for low light conditions

**MOUNTING THE RIFLESCOPE**

Choose rings and bases that correspond to your firearms action and the diameter of your riflescope's maintube. In order to maintain a comfortable cheek weld always mount your riflescope with the lowest possible ring height. Make sure that there is no interference with any of the moving parts of your firearm.

**Set proper eye relief**

Slightly loosen the riflescope rings and position the riflescope as far forward as it will mount. For adjustable power riflescopes select the highest possible power. Mount the rifle in a comfortable and repeatable, natural position. Adjust the position of the riflescope backwards until you have maximum field of view in your riflescope.

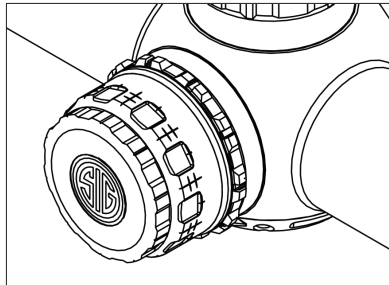

## Leveling your riflescope

LevelPlex® can be utilized as a mounting aid. Make sure that your firearm is level and activate LevelPlex. When the indicators show that the scope is level tighten your rings to the appropriate torque.

## SIGHT ADJUSTMENTS

### Focusing the reticle with the diopter

Aim the riflescope at a light object to maximize the contrast of the reticle. Turn the diopter until the reticle comes into focus.

### Adjusting Power

SIERRA™ riflescopes are variable power. In order to increase the power setting, rotate the power selector ring clockwise. Turn the power selector ring until the image is magnified to the desired range.

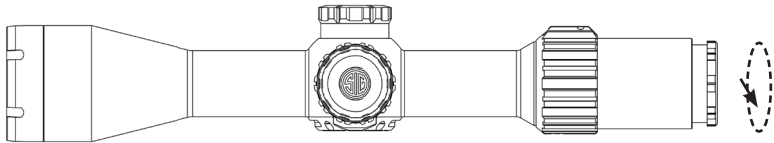

## Bore sighting

With the rifle in a firm rest, remove the bolt from your rifles action (with AR style rifles remove the rifles upper from its lower assembly and remove the bolt carrier). Look through the rifles barrel from the rear of the rifle and aim it so that your target is centered. Without moving the position of the barrel, use the elevation and windage adjustments of your riflescopes reticle so that it is also in the center of the target.

## Parallax Adjustment\*

When using your riflescope for longer range targets, parallax can become more noticeable. This can be noticed when it appears that your reticle is moving separate from the target when you move your head/eye from side to side. To adjust parallax, rotate the parallax dial clockwise for increased distances. Turn the dial until the parallax, is corrected.

\*Certain models offer adjustment on the left side of the turret.

## Point of Impact (POI) corrections

**It is recommended, but not required, to use a 100 yard/meter zero. This typically will put most of your impacts below the horizontal crosshair on your reticle. This ensures that the BDX® system will be able to provide the most accurate solution.**

POI corrections should be done using the center of a three shot group. If you are not able to get a consistent three shot group then you will need to troubleshoot your rifle further.

If your POI is located to the left of your point of aim (POA) then you need to adjust the windage to the right. The value of each click is marked on your riflescope. To move your POI to the right you will need to turn the windage turret counter-clockwise. To move your POI left, turn the windage turret clockwise.

If your POI is located below your POA then you need to adjust your elevation up. The value of each click is marked on your riflescope. To move your POI up you will need to turn the elevation turret counter-clockwise. To move your POI down, turn the elevation turret clockwise.

The goal of these adjustments is for your point of impact to match up with your point of aim. You will need to make windage or elevation adjustments in order to accomplish this.

## CONFIGURING AND USING SMARTBDC™

There are eight preestablished ballistic groups on your SIERRA™ riflescope. The first six groups are centerfire groups. Group 1 is the flattest shooting group with the least drop. As the group numbers increase, so does the bullet drop. Using the included Ballistic Groups card, locate your caliber from the provided list. If your rounds are impacting low then move to a higher numbered group. If your rounds are impacting high then move to a lower numbered group. Group 7 represents common muzzleloaders and Group 8 represents an average crossbow.

Once you have selected a ballistic group for your cartridge, turn your rifle scope's illumination control to "OFF" and rotate the power selector to the lowest level of magnification until it stops (counterclockwise). Next, rotate the illumination control to the number of the corresponding group you would like to use. Use 1 for Group 1, 2 for Group 2 etc. Once you've selected the group, rotate the power selector ring, clockwise, to the highest level of magnification, and back to the lowest. Repeat this cycling of the magnification three times to lock in your selection. The blue BDX® LED will blink to confirm your selection.

For fixed MOA holds, use the above process and select illumination control level 9. This will activate fixed hold points at zero, 5, 10, 15 and 20 MOA drops.

After confirming a ballistic group, the reticle will display 5 active hold points. The center point is your zero distance and each subsequent dot represents an additional 100 yards of drop out to 500 yards.

To disable ballistic groups, follow the above process and select illumination level 10. This will activate the illuminated center point only.

For a more precise group, please configure BDX smartphone app.

## Re-setting your zero - SIERRA™

To reset your zero on both the windage and elevation dials on your SIERRA riflescope, loosen the 2 mm hex screw on the top of the dial, align dial to zero and retighten to finger tightness. Be careful not to rotate the adjustments during this process. Replace the adjustment dial cover.

## BALLISTIC DATA XCHANGE – DOWNLOADING AND CONFIGURING THE FREE BDX® APP

In this section you will download the BDX App, pair the App with your SIERRA and create a custom bullet profile.

### 1. Turn Bluetooth on

Check in Settings on your Android or iOS device to make sure that Bluetooth is on. If Bluetooth is off, switch it on.

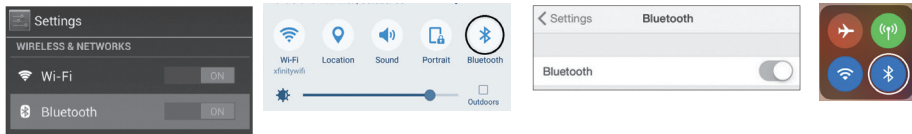

### 2. Download the BDX® App from the App Store / Google Play Store

Go to the App Store or the Google Play store and download the SIG SAUER BDX App. Search for the word SIG SAUER or BDX.



### 3. Launch the free SIG SAUER BDX® App and Pair with your SIERRA™

On your smartphone, open the BDX App, click on PAIRING, turn on your SIERRA by rotating the illumination brightness setting to any position and then press "Scan for Devices" on the App. Your SIERRA should be listed below the SIERRA icon and "Select Device". Your sight ID should be listed in white letters. Touch the ID in white. (continued on next page)

You will be prompted to rotate your illumination brightness settings to a new position. Once completed, press OK to complete the pairing operation. You will now see your SIERRA ID in blue listed below the SIERRA icon. You can now exit this screen. If you enter the incorrect PIN code you can restart this process over again. If you encounter any problems during this process close your App and let the SIERRA time out; restart the process over.

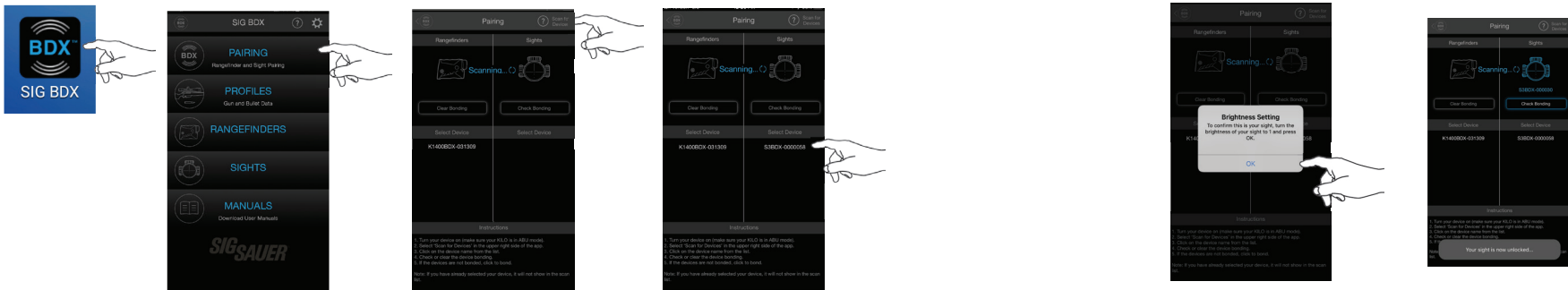



### 3a. Updating your SIERRA™ to the latest software during Pairing

You may be prompted to update the software on your SIERRA. These software updates are mandatory and allow SIG SAUER to ensure that your BDX® App and SIERRA perform optimally. Most updates take less than 1 minute. Ensure that your SIERRA is turned on and that your smartphone has at least 25% battery life remaining before installing any software updates. For best operation be sure to keep your smartphone awake during the entire installation process.

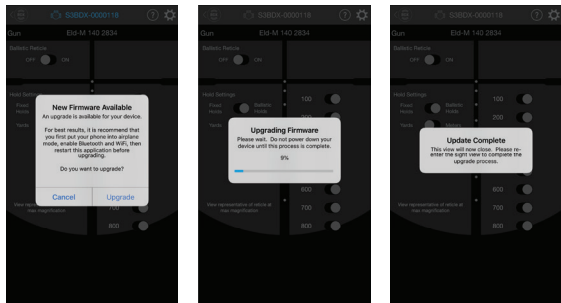

### 4. Configure up to 25 custom bullet profiles

The BDX® App allows you to create and modify up to 25 profiles. From the home screen of the App touch PROFILES. Only one profile can be active at any time and is denoted by the BDX Icon in blue to the right of the screen. The BDX App comes with one default 0.308 profile. You can edit this profile by touching “Profile 1” or create a new one by touching the “New Profile” in the upper right corner of the App. Next, touch LIBRARY then select a caliber and bullet manufacturer. On the Gun Profiles page you can rename the profile by touching on the “Custom Gun 1” and typing in a new name.

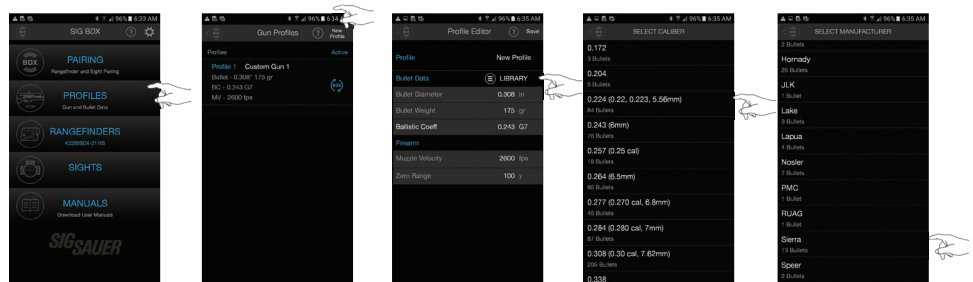

After selecting a bullet manufacturer, select the actual bullet you intend to use. Once selected you will return to the Gun Profile page where you will need to click on the sync icon to the right to activate this profile. In this example the new profile is called “.223 Sierra” – be sure to activate this profile.

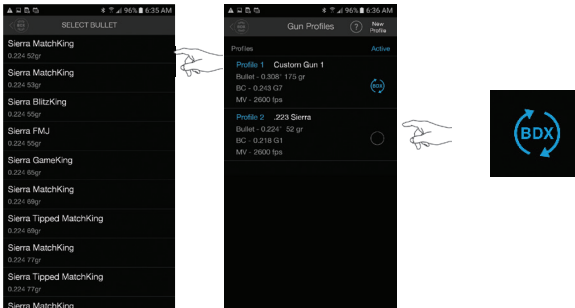

## CONFIGURING YOUR SIERRA™ RIFLESCOPE

Once you have paired your SIERRA with your app you can enter the Sights page and configure your riflescope. In the upper right hand corner of the sights page is the setting icon. SIERRA Settings Options (Defaults in BOLD)

### LevelPlex®

Off, **Auto** (Not available in Ballistic Reticle Mode), 0.5, 1.0, 2.0, 3.0  
This adjusts the sensitivity of your LevelPlex indicators. If you are paired to a BDX® rangefinder and in auto mode your LevelPlex indicators will vary based on the distance that is ranged. This allows for less sensitivity at closer distances and more sensitivity at further distances where precision is more important.

### MOTAC™ Timeout

Off, 1 Min, 2 Min, **5 Min**, 10 Min  
MOTAC will turn your sight off if your sight is motionless for this amount of time. MOTAC is very sensitive so your sight must be absolutely still in order to trigger MOTAC.

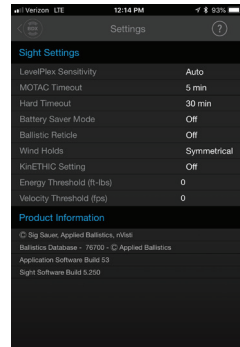

**Hard Timeout**

Off, **30 Min**, 60 Min, 2 Hours, 4 Hours, 8 Hours

The hard timeout setting will turn your sight off after this amount of time. Any change to the Illumination brightness setting or power selector magnification level will turn the sight back ON.

**Battery Saver Mode**

Off, On

The BDX® system remains fully functional with reticle update indicated in the rangefinder with a flashing Bluetooth symbol and with reticle animation in the sight. Only the Blue LED is powered off in battery saver mode.

**Ballistic Reticle Mode**

Off, On

This will toggle your ballistic reticle with multiple holdover dots on or off. You will need to configure your ballistic reticle from the sights page.

**Wind Holds**

Off, **Symmetrical**, Directional

Wind holds are only available when you are paired to a BDX rangefinder. These wind holds will correspond to the wind value that is selected for your BDX rangefinder on the rangefinder page. The symmetrical option will give you both left and right wind holds if you are shooting in varying conditions or in varying directions. Always hold into the wind. A directional wind hold will only give you one value for the direction that is selected on the rangefinder page.

**KinETHIC™ Setting**

Off, Energy, Velocity

KinETHIC will indicate if your terminal ballistics are below the threshold that you have chosen. If you select energy as your threshold and your bullet is below that threshold for the distance that has been ranged your SIERRA™ hold over point will flash twice and then stay solid for 2 seconds.

**Note:** If your ballistic hold over dot is flashing quickly at the bottom of your reticle that means that your true hold over is out of the field of view of your reticle. Reduce the magnification level of the riflescope. As your true ballistic hold over dot comes into your field of view it will light up solid. Using ABU your BDX® system will only provide ballistic solutions for 800 yards and closer. In ABE/ABX mode you are able to connect your BDX system to external ballistic calculators that provide solutions further than 800 yards.

## BDX-R1 Digital Ballistic Reticle

If you are not using a SIG SAUER BDX® rangefinder, you can choose to set up your riflescope with a custom Digital Ballistic Reticle (DBR). You can input your known ballistic holds or use a custom reticle made for you via the BDX app.

To turn on your DBR, toggle the DBR ON/OFF button on the sights page.

You have the option of using fixed holds or ballistic holds. If you choose fixed holds you can enter in your desired hold overs in either MILS or MOA. You have the ability to illuminate up to 8 hold over dots. If you choose ballistic holds you can choose up to 8 different distances to illuminate. These distances can be in either meters or yards. The default is 100 yard increments. To change these increments tap on the yardage you would like to change and enter your new value. You are able to toggle each hold over on and off. The ballistics for these hold overs correspond to the gun profile that you have chosen as active.

It is highly recommended that you verify your hold overs for the furthest distance that you plan to shoot. If you are not using a SIG SAUER BDX rangefinder you can choose to set up your riflescope with a custom Digital Ballistic Reticle (DBR). You can input your known ballistic holds or use a custom reticle made for you via the BDX app.

## Muzzle Velocity Calibration

In order to calibrate your muzzle velocity in the sights page, click on the “Calibrate Ballistic Reticle” button in the upper right hand corner of the sights page. Follow the prompts on the screen. Note: the distance that you need to calibrate your muzzle velocity at must be 300 yards or more. The furthest hold over that is toggled on will be the distance that the app calibrates at. If you are shooting at 400 yards toggle all further distances off.



## FAQ

### **Q: My hold over dot is flashing**

A: If your hold over dot is flashing twice and then staying lit for 2 seconds that means that your KinETHIC™ threshold has been triggered. If your hold over dot is flashing continuously and quickly that means that your true hold over is outside of the field of view of the reticle. Reduce the riflescopes magnification until the hold over dot is lit solid.

### **Q: My app cannot find my SIERRA™**

A: Make sure that your SIERRA is turned on and that your battery port cover is firmly tightened down. Make sure that the Bluetooth is turned on with your iOS/Android device. Make sure that your SIERRA is not connected to any other devices.

### **Q: My rangefinder will not communicate with my SIERRA**

A: Turn Ballistic Reticle OFF in sight settings, set rangefinder to ABU mode in rangefinder settings

## MAINTENANCE

Your SIG SAUER riflescope requires very low maintenance.

- If your riflescope came with turret caps make sure that they are installed when you are not making windage or elevation adjustments.
- Make sure that you turn the illumination control to one of the off positions when it is not in use.
- If the battery for your illuminated reticle is dead replace it by rotating the illumination battery port cap counter-clockwise. Replace the batteries with new CR2032 batteries with the positive side facing in.
- Keep your lenses clear by using a soft cloth or lens pen. The best way to maintain image quality is by keeping your lenses clear of dirt and dust that cause scratches.

## TROUBLESHOOTING

### **POI changes between groups**

- Check that all of your mounts are tightened to the correct torque spec
- Check/Clean your rifle
- Check for variations in ammunition

### **Illuminated reticle does not work**

- Check that the battery is installed correctly
- Replace battery
- Ensure that the illumination power selector ring is in an on position



### SIG SAUER Electro-Optics Infinite Guarantee™

SIG SAUER has manufactured the most rugged, dependable high-performance firearms for over two centuries. Our heritage of design, engineering and precision-manufactured quality predates the existence of any other optics company worldwide. We understand the importance of quality in the line of fire, at the shooting range or on your next hunt. SIG SAUER Electro-Optics had to earn the right to wear that badge and the Infinite Guarantee has your back, forever. Period.

We will repair or replace your SIG SAUER product in the event it becomes damaged or defective, at no charge to you. If we cannot repair your product, we will replace it with a product in perfect working order of equal or better physical condition. It doesn't matter how it happened, whose fault it was, or where you purchased it.

### SIG SAUER Infinite Guarantee™

- Unlimited Lifetime Guarantee
- Fully Transferable
- No Warranty Card Required
- No Receipt Required
- No Time Limit Applies
- No Charge

If you ever have a problem, no matter the cause, we promise to take care of you when it counts. Please note that our Infinite Guarantee does not provide coverage for intentional damage, misuse, cosmetic damage that does not affect the performance of the optic, loss, theft or unauthorized repair or modification. Excludes electronic components.



### SIG SAUER Electronic & Tritium Component Limited 5-Year Warranty

For components not included under the SIG SAUER® Infinite Guarantee™, this warranty covers any defects in materials and workmanship in the electronic and Tritium components of illuminated riflescopes/sights, pistol sights, electronic sights, flashlights, lasers, binoculars, spotting scopes, and rangefinders. This warranty lasts for five years from the date of manufacture. If, during that five-year period, these products are found

to have electronic or Tritium component defects in materials or workmanship, SIG SAUER will repair your product, at no charge to you. If we cannot repair your product, we will replace it with a product in perfect working order of equal or better physical condition.

**NOTICE:** Export restrictions may apply – this product may be controlled either by the ITAR or EAR.

**⚠ WARNING:** CANCER AND REPRODUCTIVE HARM – [www.P65Warnings.ca.gov](http://www.P65Warnings.ca.gov)





**FOR PRODUCT SERVICE ON THIS MODEL, PLEASE CALL 603-610-3000**

27100 SW Parkway Avenue, Wilsonville, OR 97070 USA