



**IMPORTANT INSTRUCTIONS FOR**

**MODEL 1892<sup>™</sup>**

**LEVER-ACTION AND**

**LEVER-ACTION**

**TAKEDOWN RIFLES**

---

This owner's manual is for Winchester<sup>®</sup> Model 1892<sup>™</sup> lever-action rifles only. Supplemental instructions for special edition Model 1892 rifles must be used in conjunction with the instructions found in this owner's manual. If your supplemental instructions are missing, contact us immediately for a free copy or download one online at [winchesterguns.com](http://winchesterguns.com).

Winchester Repeating Arms  
275 Winchester Avenue  
Morgan, UT 84050-9333  
(800) 945-5237  
[winchesterguns.com](http://winchesterguns.com)

Winchester is a registered trademark of Olin Corporation.

---

# WINCHESTER®

REPEATING ARMS

Important instructions for the

## Winchester® Model 1892™

### Lever-Action Rifle

Winchester Repeating Arms

Customer Service Department (United States)

275 Winchester Avenue

Morgan, Utah 84050-9333

Phone: (800) 945-5237

If you have any questions or comments regarding your new firearm, please feel free to write or call us. Use the space below to record information about your new firearm.

Model \_\_\_\_\_

Serial Number \_\_\_\_\_

Caliber \_\_\_\_\_

Grade \_\_\_\_\_

Purchase Price \_\_\_\_\_

Purchased From \_\_\_\_\_

Date of Purchase \_\_\_\_\_

Specifications within this owner's manual are correct at the time of printing and subject to change without notice.

# WINCHESTER®

REPEATING ARMS

CONTENTS	PAGE
State Warning.....	2
WARNING: You Are Responsible For Firearms Safety.....	2
General Description and Operation .....	10
Nomenclature .....	10
Serial Number.....	14
Initial Cleaning and Oiling.....	14
Operation of the “Safety” .....	15
Rebounding Hammer.....	17
Ammunition .....	19
Loading .....	20
Firing.....	24
Unloading .....	26
Sight Adjustment.....	27
Takedown Models.....	29
Cleaning and Maintenance Suggestions .....	37
Parts, Service, Repair and Questions .....	40
Website Information .....	42

The Model 1892™ was born from the incredible success of the Model 1886 when it became obvious that a smaller caliber version would be an extremely useful addition. Like its predecessor, the Model 1892 features dual, vertical locking lugs for impressive strength in a more compact, even faster handling size.

The popularity of the Model 1892 is legendary. Admiral Peary carried one on his quest for the North Pole. It was a favorite of Annie Oakley, and the first choice for the legendary actor John Wayne. Hundreds of thousands of ranchers and hunters have chosen the Model 1892 over the competition for over a century.

## STATE WARNING

According to state law, California requires that firearm manufacturers, distributors and retailers include conspicuous, specific warnings with firearms sold in that state.

### **WARNING**

Firearms must be handled responsibly and securely stored to prevent access by children and other unauthorized users.

California has strict laws pertaining to firearms, and you may be fined or imprisoned if you fail to comply with them. Visit the Web site of the California Attorney General at <https://oag.ca.gov/firearms> for information on firearm laws applicable to you and how you can comply.

Prevent child access by always keeping guns locked away and unloaded when not in use. If you keep a loaded firearm where a child obtains and improperly uses it, you may be fined or sent to prison.

### **ADVERTENCIA**

Las armas de fuego deben de ser manipuladas responsablemente y almacenadas en sitios seguros para prevenir el acceso a ellas por parte de niños y personas sin autorización.

California cuenta con leyes estrictas sobre las armas de fuego, y puede ser multado y encarcelado si no las obedece. Visite la página web de California Attorney General, <https://oag.ca.gov/firearms> para más información sobre cómo cumplir con las leyes de armas de fuego.

Prevenga el acceso de los niños a las armas de fuego manteniéndolas siempre en un lugar seguro, bajo llave y descargadas cuando no estén en uso. Si usted deja un arma cargada al alcance de un niño, y éste la utiliza indebidamente, usted podría ser multado e incluso enviado a la cárcel.

## WARNING: YOU ARE RESPONSIBLE FOR FIREARMS SAFETY

### **WARNING**

**FAILURE TO FOLLOW ANY OF THE FOLLOWING WARNINGS COULD RESULT IN SERIOUS INJURY OR DEATH.**

As a firearm owner, you accept a set of demanding responsibilities. How seriously you take these responsibilities can be the difference between life and death.

There is no excuse for careless or abusive handling of any firearm. At all times handle this firearm and all other firearms with intense respect for their power and potential danger.

Please read and understand all of the cautions, warnings, notices, proper handling procedures and instructions outlined in this owner's manual before using your new firearm.

**1 ALWAYS KEEP THE MUZZLE OF YOUR FIREARM POINTED IN A SAFE DIRECTION EVEN THOUGH YOU ARE CERTAIN IT IS UNLOADED.**

Never point any firearm at anything you do not intend to shoot. Be extremely alert and aware of all persons and property within the range of your ammunition.

**2 NEVER RELY TOTALLY ON YOUR FIREARM'S MECHANICAL "SAFETY" DEVICE. LIKE ANY MECHANICAL DEVICE, A "SAFETY" CAN SOMETIMES FAIL; IT CAN BE JARRED OR INADVERTENTLY MANIPULATED INTO AN UNSAFE CONDITION.**

The word "safety" describes a firearm's trigger block mechanism, sear block mechanism, hammer block mechanism or firing pin block mechanism. Mechanical "safeties" are designed to place your firearm in a safer status, and no guarantee can be made that the firearm will not fire even if the "safety" is in the on safe position. Mechanical "safeties" merely aid safe gun handling and are no excuse for pointing your firearm's muzzle in an unsafe direction. See "Operation of the "Safety" on pages 15-16 for instructions on the operation of this firearm's "safety."

Remember, safe gun handling does not stop with your firearm's mechanical "safety" devices, it starts there. Always treat this firearm with the respect due a loaded, ready-to-fire firearm.

Some firearms do not have a mechanical "safety." Many target firearms, lever-action firearms and pistols do not have manual "safety" mechanisms. Therefore it is critical to read and understand the owner's manual for every firearm which explains the safe operation of the firearm.

While it is a good idea to test your firearm's mechanical "safety" periodically for proper function, never test the "safety" while your firearm is loaded or pointed in an unsafe direction.

### **3 WHENEVER YOU HANDLE ANY FIREARM, OR HAND IT TO SOMEONE, ALWAYS OPEN THE ACTION IMMEDIATELY AND VISUALLY CHECK THE FIREARM'S CHAMBER TO MAKE CERTAIN THAT THE FIREARM IS COMPLETELY UNLOADED.**

Make certain the firearm does not inadvertently contain any ammunition. Remember, merely removing the magazine does not mean the chamber is unloaded. Always keep the chamber empty and the "safety" in the on safe position unless shooting is imminent.

### **4 ALWAYS WEAR EAR AND EYE PROTECTION WHEN SHOOTING.**

Unprotected, repeated exposure to gunfire can cause hearing damage. Wear hearing protection (shooting earplugs or muffs) to guard against such damage.

Wear shooting glasses to protect your eyes from flying particles. Allow proper distance (eye relief) between a scope and your eye when firing a scoped pistol, rifle or shotgun. Do not use unorthodox shooting methods that could cause the rearward travel of the slide or bolt of a firearm to contact your eyes, face or hands. Always keep a safe distance between the muzzle of your firearm and any persons nearby, as muzzle blast, debris and ejecting cartridges could inflict serious injury.

Always wear eye protection when disassembling and cleaning any firearm to prevent the possibility of springs, spring-tensioned parts, solvents or other agents from contacting your eyes.

### **5 KEEP ALL FIREARMS UNLOADED DURING TRANSPORT, EVEN WHEN STORED IN A HOLSTER, GUN CASE, SCABBARD OR OTHER CONTAINER.**

### **6 DROPPING OR JARRING A LOADED FIREARM CAN CAUSE ACCIDENTAL DISCHARGE.**

This can occur even with the "safety" in the on safe position. Be extremely careful while hunting or during any shooting activity to avoid dropping any firearm.

### **7 HUNTING FROM ELEVATED SURFACES SUCH AS TREESTANDS IS DANGEROUS.**

Doing so may increase the risk of mishandling a firearm. The following rules should always be observed by you and those you hunt with. Always make certain that the stand being used is safe and stable. Always make certain that your firearm is unloaded when it is being taken up and down from the stand. Always make certain that your firearm is not dropped from the stand, or dropped while it is being taken up or down from the stand. Remember, a loaded firearm may discharge when dropped, even with the “safety” in the on safe position.

### **8 STORE YOUR FIREARM AND AMMUNITION SEPARATELY, WELL BEYOND THE REACH OF CHILDREN.**

Take prudent safeguards to ensure your firearm does not become available to untrained, inexperienced or unwelcome hands. Store all firearms in secure, locked cases or a gun safe. Keep your firearm unloaded when not in use.

### **9 BEWARE OF BARREL OBSTRUCTIONS.**

Mud, snow and an infinite variety of other objects may inadvertently lodge in a barrel bore. It only takes a small obstruction to cause dangerously increased pressures that can damage your firearm and cause serious injury to yourself and others.

**BEFORE CHECKING FOR A BARREL OBSTRUCTION, BE CERTAIN YOUR FIREARM IS COMPLETELY UNLOADED, THERE IS NOT A LIVE CARTRIDGE IN THE CHAMBER AND THE “SAFETY” IS IN THE ON SAFE POSITION.**

After ensuring that the firearm is completely unloaded, open the breech or action and look through the barrel to be sure it is clear of obstructions. If an obstruction is seen, no matter how small it may be, clean the bore with a cleaning rod and patch as described on pages 37-40 of this owner’s manual.

**10 BE ALERT TO THE SIGNS OF AMMUNITION MALFUNCTION. IF YOU DETECT AN OFF SOUND OR LIGHT RECOIL WHEN A CARTRIDGE IS FIRED, DO NOT LOAD ANOTHER CARTRIDGE INTO THE CHAMBER.**

If your firearm fails to fire, keep the muzzle pointed in a safe direction for a minimum of 30 seconds. Carefully rotate the top of the firearm away from you, open the action and remove the cartridge from the chamber. If the primer is indented, the defective cartridge should be disposed of in a way that cannot cause harm. If the primer is not indented, your firearm should be examined by a qualified gunsmith and the cause of the malfunction corrected before further use. Glance down the barrel to make sure that no obstructions remain in the barrel. Completely clear the barrel before loading and firing again. Failure to follow these instructions can cause extensive damage to your firearm and possible serious injury to yourself and others.

**11 NEVER INSERT A CARTRIDGE OF THE INCORRECT CALIBER INTO ANY FIREARM.**

The caliber of your firearm is marked on the barrel. Store all cartridges of different calibers in completely separate and well-marked containers. Never store cartridges of mixed calibers in a common container or in your pockets. See pages 19-20 for more information on the correct ammunition for your firearm.

**12 EXAMINE EVERY CARTRIDGE YOU PUT IN YOUR FIREARM.**

We assume no responsibility for the use of unsafe or improper firearm and ammunition combinations or damage or injury caused by damaged ammunition. It is your responsibility to read and heed all warnings in this owner's manual and on ammunition boxes. See pages 19-20 for more information on the correct ammunition for your firearm.



## **13 USE ONLY SAAMI APPROVED AMMUNITION.**

The barrel and action of this firearm have been made with safety margins over the pressures established by the Sporting Arms and Ammunition Manufacturers' Institute (SAAMI) for Service Cartridges. However, we assume no responsibility for incidents which occur through the use of cartridges of nonstandard dimension or those developing pressures in excess of SAAMI established standards.

## **14 DISCHARGING FIREARMS IN POORLY VENTILATED AREAS, CLEANING FIREARMS OR HANDLING AMMUNITION MAY RESULT IN EXPOSURE TO LEAD AND OTHER SUBSTANCES KNOWN TO CAUSE BIRTH DEFECTS, REPRODUCTIVE HARM AND OTHER SERIOUS PHYSICAL INJURY. HAVE ADEQUATE VENTILATION AT ALL TIMES. WASH HANDS THOROUGHLY AFTER EXPOSURE.**

## **15 DO NOT SNAP THE FIRING PIN ON AN EMPTY CHAMBER; THE CHAMBER MAY NOT BE EMPTY!**

Treat every firearm with the respect due a loaded firearm, even though you are certain the firearm is unloaded.

## **16 KEEP YOUR FINGERS AWAY FROM THE TRIGGER WHILE LOADING AND UNLOADING UNTIL SHOOTING IS IMMINENT.**

## **17 BE SURE OF YOUR TARGET AND BACKSTOP, PARTICULARLY DURING LOW LIGHT PERIODS.**

Know the range of your ammunition. Never shoot at water or hard objects.

## **18 ALWAYS UNLOAD YOUR FIREARM'S CHAMBER BEFORE CROSSING A FENCE, CLIMBING A TREE, JUMPING A DITCH OR NEGOTIATING OTHER OBSTACLES.**

Never place your firearm on or against a fence, tree, car or other similar object.

## **19 BE DEFENSIVE AND ON GUARD AGAINST UNSAFE GUN HANDLING AROUND YOU AND OTHERS.**

Don't be timid when it comes to firearm safety. If you observe other shooters violating any of these safety precautions, politely suggest safer handling practices.

## **20 BE CERTAIN YOUR FIREARM IS UNLOADED BEFORE CLEANING.**

Special and extreme care should be taken to be sure your firearm is unloaded before disassembly, cleaning and reassembly.

Keep ammunition away from the cleaning location. Never test the mechanical function of any firearm with live ammunition.

## **21 TEACH AND SUPERVISE FIREARMS SAFETY TO ALL MEMBERS OF YOUR FAMILY, ESPECIALLY TO CHILDREN AND NON-SHOOTERS.**

Closely supervise newcomers to the shooting sports. Encourage enrollment in hunting and shooting safety courses.

## **22 NEVER DRINK ALCOHOLIC BEVERAGES OR TAKE ANY TYPE OF DRUGS BEFORE OR DURING SHOOTING.**

Your vision, motor skills and judgment could be dangerously impaired, making your gun handling unsafe to you and to others.

## **23 READ AND HEED ALL WARNINGS IN THIS OWNER'S MANUAL, ON AMMUNITION BOXES AND WITH ALL ACCESSORIES THAT YOU INSTALL ON YOUR FIREARM.**

It is your responsibility to secure the most up-to-date information on the safe handling procedures of your Winchester firearm. We assume no liability for incidents which occur when unsafe or improper firearm accessories or ammunition combinations are used.

## **24 PRACTICE PERIODIC MAINTENANCE, AVOID UNAUTHORIZED SERVICING.**

Your firearm is a mechanical device which will not last forever, and as such, is subject to wear and

requires periodic inspection, adjustment and service. Winchester firearms should be serviced by a Winchester Repeating Arms Authorized Repair Center or by our Service Facility in Arnold, Missouri. We assume no responsibility for injuries suffered or caused by unauthorized servicing, alterations or modifications of Winchester firearms.

**25 DO NOT, UNDER ANY CIRCUMSTANCES, ALTER THE TRIGGER, "SAFETY" OR OTHER PARTS OF THE FIRING MECHANISM OF THIS OR ANY OTHER FIREARM EXCEPT AS OTHERWISE DESCRIBED IN THIS MANUAL.**

We reserve the right to refuse service on firearms that have been altered, added to or substantially changed. Removal of metal from the barrel, or modifications of the firing mechanism and/or operating parts may lead to a refusal of service on such firearms. You will be charged for parts and labor to return the firearm to original specifications prior to servicing your firearm.

With respect to **AFTERMARKET PARTS OR COMPONENTS** (including, for example, aftermarket trigger systems, barrels, muzzle brakes, suppressors, magazines, etc.), **USE AT YOUR OWN RISK.**

Winchester firearms are designed and engineered to meet stringent safety standards. Winchester Repeating Arms is not responsible for personal injuries or property damage caused by alterations to a firearm. This includes the incorporation of aftermarket parts or components that may or may not satisfy Sporting Arms and Ammunition Manufacturers' Institute (SAAMI) standards (for example, an aftermarket trigger system may not satisfy SAAMI minimum trigger pull standards, etc.) or may create other dangerous conditions. These conditions may or may not be apparent to the user (for example, installing an aftermarket barrel may have the effect of altering critical firearm dimensions, including headspace, and may create an unsafe firing condition, etc.).

# WINCHESTER®

REPEATING ARMS

**FIGURE 1**

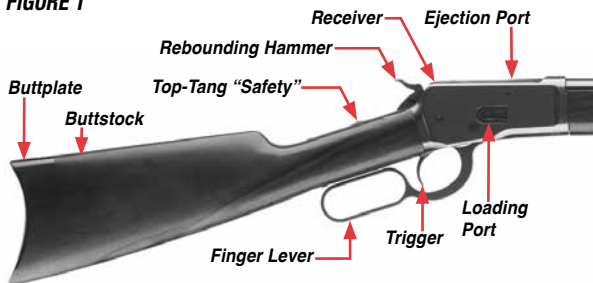

Aftermarket parts or components that do not satisfy SAAMI standards, or that could create other dangerous conditions, should not be used.

**FAILURE TO FOLLOW THIS WARNING COULD RESULT IN SERIOUS INJURY OR DEATH, AS WELL AS CAUSE DAMAGE TO YOUR FIREARM.**

## BE CAREFUL!

### GENERAL DESCRIPTION AND OPERATION

The Model 1892 rifle is one of the firearms that changed the face of America during the late 1800s. Conceived from the genius of John M. Browning, the lever-action Model 1892 is a scaled-down version of the powerful Model 1886. Cowboys and frontiersmen preferred a rifle that fired the same ammunition as their sidearms, and a smaller version of the rugged, reliable Model 1886 design was a natural choice. The Model 1892 features dual, vertical locking lugs for strength in a compact, faster handling size.

### NOMENCLATURE

Descriptions in this owner's manual generally refer to the firearm in the horizontal, normal firing position. For example, the muzzle is forward or front; the buttstock is rearward or rear; the trigger is downward or underneath; the sights are upward or on top.

Throughout this owner's manual the action refers to the mechanism of this rifle which loads and secures the cartridge in the chamber.

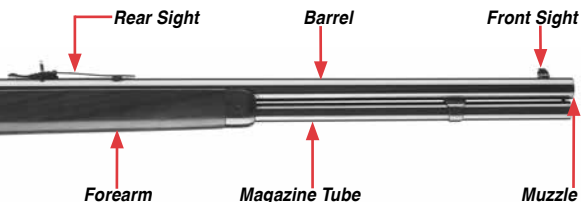

Refer to Figures 1, 2 and 3 (pages 10-11) for general part descriptions regarding your new rifle. Figure 4 (pages 12-13) covers the general features and benefits of the Model 1892 design.

**FIGURE 2**

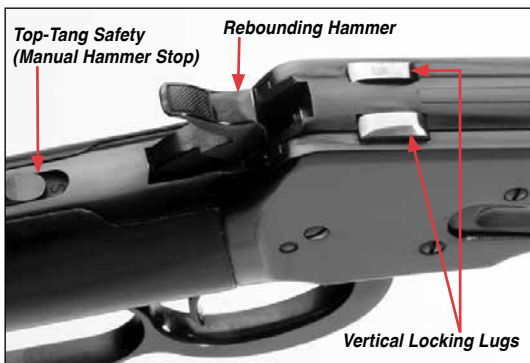

**FIGURE 3**

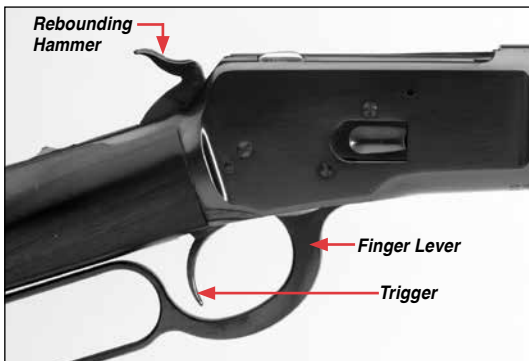

## FIGURE 4

### MODEL 1892 FEATURES

*The Model 1892 of today is a careful reproduction of one of the original configurations made over 100 years ago.*

*The Model 1892 design is visually exciting with its complex machining and hand finishing. These qualities are uncommon in most of today's mass produced guns. They are qualities that take more effort to build, something you will appreciate for years to come.*

*The two vertical locking lugs lock into matching recesses in the breech bolt for secure lockup.*

*Innovative rebounding hammer.*

*The convenient top-tang "safety" is easy to reach with the shooting hand.*

*Your Model 1892 has a beautiful stock and buttplate design patterned after classic versions popular more than a century ago.*

# WINCHESTER®

REPEATING ARMS

*Traditional open sights are easily adjustable for elevation and drift adjustable for windage.*

*The tubular magazine loads through a loading port in the right side of the receiver.*

*The Model 1892 receiver is a compact version of the revered Model 1886. Smaller, lighter and faster handling than the Model 1886, the Model 1892 shared the same cartridges as popular revolvers of the day. That meant the shooter had to carry only one caliber of ammunition to serve both the rifle and pistol. The design of the lever and link mechanisms are both clever and unique. These attributes made the compact Model 1892 a handy, fast-handling favorite.*

The appearance of your rifle may be slightly different, depending on the version you purchased.

You must become familiar with all the part names listed before proceeding with the rest of the instructions in this owner's manual.

### **SERIAL NUMBER**

The serial number of your Model 1892 can be found stamped on the bottom of the receiver, toward the front. Record the serial number at the front of this owner's manual for future reference.

### **INITIAL CLEANING AND OILING**

#### **▲WARNING**

**WEAR EYE PROTECTION WHEN ASSEMBLING AND DISASSEMBLING YOUR RIFLE TO PREVENT SPRINGS, SPRING-LOADED PARTS, SOLVENTS OR OTHER AGENTS FROM CONTACTING YOUR EYES, RESULTING IN INJURY.**

Various exposed metal parts of your new firearm have been coated at the factory with a rust preventative compound. Before firing your rifle, clean the anti-rust compound from the inside of the barrel, receiver and the action-chamber areas. A fine, light gun oil is ideal for removing this compound and for giving your new firearm its first lubrication. However, any quality firearm oil may be used. Clean the barrel using a cleaning rod and patch as explained under "Cleaning and Maintenance Suggestions" on pages 37-40. If your rifle is to be stored, it is acceptable to leave the rust preventative compound on the rifle and keep it in its original packaging.

Before the first firing of your Model 1892 you should wipe the mechanism completely clean. Clean the bore and apply a few drops of quality oil on the following surfaces (Figure 5, page 15):

- Along the breech bolt surface.
- Along the breech bolt rail surfaces.



**FIGURE 5**



- On all pivot points and bearing surfaces on the finger lever mechanism.

Avoid applying too much oil. Only a light film is necessary. Cleaning and Maintenance Suggestions should be followed before each oiling.

### OPERATION OF THE “SAFETY”

#### **▲WARNING**

**ALWAYS KEEP THE “SAFETY” IN THE ON SAFE POSITION AND THE HAMMER IN THE REBOUND POSITION UNLESS SHOOTING IS IMMINENT. ALWAYS KEEP THE MUZZLE POINTED IN A SAFE DIRECTION. FAILURE TO FOLLOW THESE WARNINGS COULD RESULT IN SERIOUS INJURY OR DEATH.**

The Model 1892 features a top-tang hammer block “safety.” When the “safety” has been placed in the on safe position it blocks the hammer from striking the firing pin. However, the “safety” does not prevent the hammer from falling when the trigger is pulled, even if the “safety” is in the on safe position. When the trigger is pulled, with the “safety” in the on safe position, the hammer drops to the rebound position without striking the firing pin. The “safety” has two positions:

**FIGURE 6**



**FIGURE 7**



- On Safe — This is the recommended position of the “safety” for all times except when firing is imminent.

To place the “safety” in the on safe position, point your rifle in a safe direction, then slide the “safety” fully to the rear with your thumb until the red warning dot is covered by the “safety” and the “S” is visible (Figure 6, page 16).

Moving the “safety” fully rearward and exposing the “S” blocks the hammer from striking the firing pin.

- Off Safe — When the “safety” is pushed all the way forward it is in the off safe position (Figure 7, page 16). In this position, when the trigger is pulled, the cocked hammer will fall and strike the firing pin. If a cartridge is in the chamber the firing pin will strike the primer and fire the cartridge.

To place the “safety” in the off safe position, point your rifle in a safe direction, then slide the “safety” fully forward, covering the “S” inscribed on the rifle, and exposing the red warning dot. When the red warning dot is visible the “safety” is in the off safe position.

The “safety” can be actuated with the hammer in the rebound or cocked position.

**FIGURE 8**

*The hammer in the rebound position.*

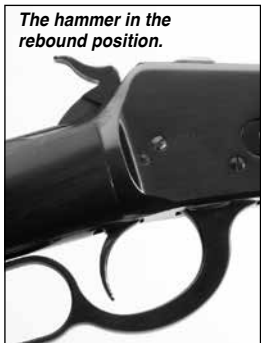

**FIGURE 9**

*The hammer in the fully-cocked position.*



### REBOUNGING HAMMER

The Model 1892 features a rebounding hammer designed to prevent the hammer from moving forward and striking the firing pin unless the trigger is pulled.

After firing your rifle the hammer immediately moves to the rebound position. The hammer can also be manually lowered from full-cock to the rebound position as detailed on pages 18 and 19 under “Lowering the Hammer.”

### HAMMER POSITIONS

The rebounding hammer on the Model 1892 has two positions:

- Rebound Position — This position (Figure 8, page 17) takes the place of the dropped and half-cock positions found on the original Model 1892 rifles.

The rebounding feature of the hammer essentially eliminates the dropped hammer position. The hammer only travels to the dropped position momentarily after the trigger has been pulled with the hammer fully-cocked. The hammer then automatically moves to the rebound position.

The rebound position is the recommended position of the hammer at all times and should be in that position except (1) when firing is imminent (2) or immediately after the action has been cycled.

- Full-Cock Position — This is the position that the hammer is moved to when firing is imminent (Figure 9, page 17). It is also the position the hammer moves to when the action is cycled using the finger lever.

**▲WARNING**

**ALWAYS KEEP THE “SAFETY” IN THE ON SAFE POSITION WHEN THE HAMMER IS IN THE FULL-COCK POSITION UNLESS FIRING IS IMMINENT. ALWAYS KEEP THE MUZZLE POINTED IN A SAFE DIRECTION. FAILURE TO FOLLOW THESE WARNINGS COULD RESULT IN SERIOUS INJURY OR DEATH.**

### *LOWERING THE HAMMER*

At any time the hammer can be moved to the full-cock position either manually or by cycling the finger lever fully. Unless shooting is imminent it is important to keep the hammer in the rebound position. To lower the hammer from the full-cock position to the rebound position, perform the following operation.

**▲WARNING**

**WHEN LOWERING THE HAMMER TO THE REBOUND POSITION, ALWAYS KEEP THE MUZZLE POINTED IN A SAFE DIRECTION. ALWAYS KEEP THE “SAFETY” IN THE ON SAFE POSITION. FAILURE TO FOLLOW THESE WARNINGS COULD RESULT IN SERIOUS INJURY OR DEATH.**

1. Place the “safety” in the on safe position.
2. Place your thumb on the hammer spur and firmly hold the hammer back slightly with your thumb.
3. While holding the hammer back, apply just enough pressure on the trigger to release the hammer from the full-cock position (Figure 10, page 19). Immediately remove your finger from the trigger, then slowly and carefully allow the hammer to lower into the rebound position (Figure 11, page 19).

**FIGURE 10**

*Hold the hammer firmly and pull the trigger.*



**FIGURE 11**

*Carefully lower the hammer to the rebound position.*



### ADDITIONAL INFORMATION

- Keep the action open (finger lever down) when your rifle is laying on a bench or table at a shooting range or other facility, and at all other times except when you are in the field and shooting is imminent or the rifle is completely unloaded and to be securely stored.

### AMMUNITION

#### **▲WARNING**

**DISCHARGING FIREARMS IN POORLY VENTILATED AREAS, CLEANING FIREARMS OR HANDLING AMMUNITION MAY RESULT IN EXPOSURE TO LEAD AND OTHER SUBSTANCES KNOWN TO CAUSE BIRTH DEFECTS, REPRODUCTIVE HARM AND OTHER SERIOUS PHYSICAL INJURY. HAVE ADEQUATE VENTILATION AT ALL TIMES. WASH HANDS THOROUGHLY AFTER EXPOSURE.**

**DO NOT USE AMMUNITION OTHER THAN WHAT IS INSCRIBED ON THE LEFT SIDE OF THE BARREL. EXAMINE EVERY CARTRIDGE YOU PUT IN YOUR FIREARM.**

**USE ONLY AMMUNITION SUITABLE FOR USE IN A CENTERFIRE RIFLE WITH A TUBULAR MAGAZINE. USE ONLY FLAT NOSE, HOLLOW POINT, ROUND NOSE FLAT POINT OR SIMILAR BULLETS. NEVER USE**

# WINCHESTER®

REPEATING ARMS

**POINTED OR CONICAL POINT BULLETS IN A CENTERFIRE RIFLE WITH A TUBULAR MAGAZINE. FAILURE TO FOLLOW THESE INSTRUCTIONS COULD RESULT IN INJURY TO YOURSELF OR OTHERS, AND CAUSE DAMAGE TO YOUR FIREARM.**

The Model 1892 is designed to shoot modern factory cartridges only. The caliber of your new Model 1892 is inscribed on the top of the barrel, just in front of the receiver. Make sure you use only the exact ammunition/caliber as listed on the barrel.

The barrel and action of this firearm have been made with safety margins over the pressures established by the Sporting Arms and Ammunition Manufacturers' Institute (SAAMI) for Service Cartridges. However, we assume no responsibility for incidents which occur through the use of cartridges of nonstandard dimension or those developing pressures in excess of SAAMI established standards.

## LOADING

### **▲WARNING**

**WHEN LOADING YOUR RIFLE ALWAYS KEEP THE MUZZLE POINTED IN A SAFE DIRECTION, ALWAYS PLACE THE "SAFETY" IN THE ON SAFE POSITION AND PLACE THE HAMMER IN THE REBOUND POSITION. KEEP YOUR FINGERS AWAY FROM THE TRIGGER. FAILURE TO FOLLOW THESE WARNINGS COULD RESULT IN SERIOUS INJURY OR DEATH.**

**DO NOT CARRY YOUR RIFLE WITH A CARTRIDGE IN THE CHAMBER TO AVOID ACCIDENTAL DISCHARGE. WHEN FIRING IS NO LONGER IMMINENT, MAKE SURE THE "SAFETY" IS IN THE ON SAFE POSITION, UNLOAD THE CHAMBER AND MAKE SURE THE HAMMER IS IN THE REBOUND POSITION. FAILURE TO FOLLOW THESE WARNINGS COULD RESULT IN SERIOUS INJURY OR DEATH.**

### LOADING THE MAGAZINE

The magazine is loaded through a port on the right side of the receiver.

1. With the action closed and the “safety” in the on safe position and the hammer in the rebound position, press the spring cover inward with the bullet tip of the first cartridge until all but the rim has entered the loading port (Figures 12 and 13, page 22).
2. Insert the next cartridge in the same manner, using it to push the preceding cartridge into the magazine.
3. Repeat this procedure with each cartridge, pushing the last cartridge past the end of the spring cover and allowing the cover to snap closed (Figure 14, page 22). Do not exceed the recommended capacity of the magazine.

### **LOADING DIRECTLY TO THE CHAMBER**

The chamber of your rifle may be loaded by placing a cartridge directly into the chamber through the opened action, or by transferring a cartridge that was previously loaded into the magazine to the chamber by operating the finger lever.

1. Place the “safety” in the on safe position.
2. To load a cartridge directly into the chamber, open the action by pulling the finger lever downward and fully forward.
3. Insert a cartridge directly into the chamber.
4. Close the action by pulling the finger lever upward. Keep your fingers away from the trigger.

### **▲WARNING**

**THE RIFLE IS NOW READY TO FIRE BY SIMPLY MOVING THE “SAFETY” TO THE OFF SAFE POSITION AND PULLING THE TRIGGER.**

Immediately move the hammer to the rebound position as explained on pages 17-19.

5. Load the magazine as previously explained.

### **LOADING THE CHAMBER FROM THE MAGAZINE**

1. Place the “safety” in the on safe position.
2. Load the magazine as explained on pages 20-21.

**FIGURE 12**

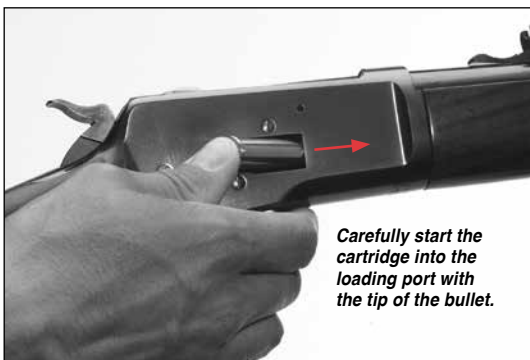

**FIGURE 13**

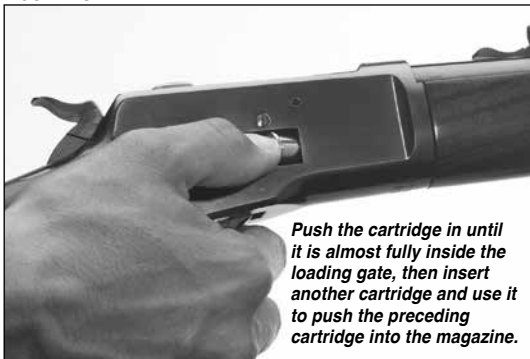

**FIGURE 14**

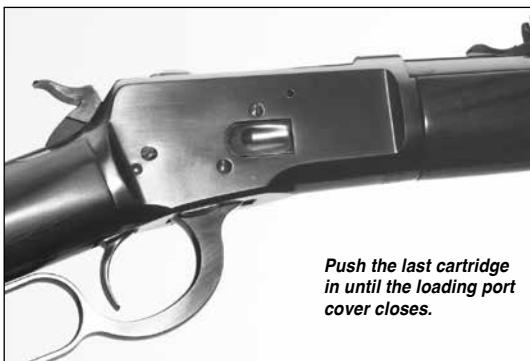
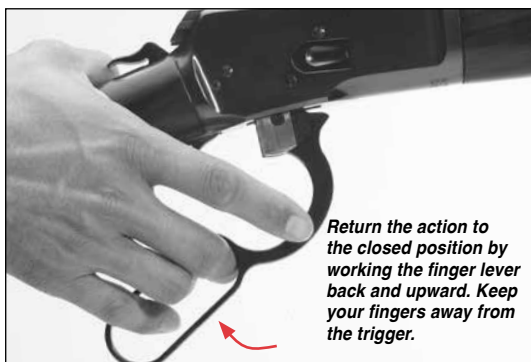



**FIGURE 15**



**FIGURE 16**



3. Open the action by pulling the finger lever downward and fully forward (Figure 15, page 23).
4. Close the action by pulling the finger lever back and upward (Figure 16, page 23). This transfers a cartridge from the magazine into the chamber. Keep your fingers away from the trigger.

**▲WARNING**

**THE RIFLE IS NOW READY TO FIRE BY SIMPLY MOVING THE “SAFETY” TO THE OFF SAFE POSITION AND PULLING THE TRIGGER.**

**FIGURE 17**

*When firing is imminent pull the hammer back to the full-cock position.*



Immediately move the hammer to the rebound position as explained on pages 17-19.

5. You may now load a single cartridge into the magazine to fill it to maximum capacity.

## **FIRING**

### **▲WARNING**

**NEVER CHAMBER A CARTRIDGE, MOVE THE “SAFETY” FROM THE ON SAFE POSITION OR COCK THE HAMMER UNLESS SHOOTING IS IMMINENT. ALWAYS KEEP THE MUZZLE POINTED IN A SAFE DIRECTION. FAILURE TO FOLLOW THESE WARNINGS COULD RESULT IN SERIOUS INJURY OR DEATH.**

1. Load the chamber of the rifle as explained previously.
2. Firmly position your thumb on the hammer and draw the hammer back to the full-cock position (Figure 17, page 24).

### **▲WARNING**

**THE RIFLE IS NOW READY TO FIRE BY SIMPLY MOVING THE “SAFETY” TO THE OFF SAFE POSITION AND PULLING THE TRIGGER.**

3. Place the “safety” in the off safe position.

4. Take aim, and when on target, squeeze the trigger. After firing, release the trigger to the fully forward position.
5. Swing the finger lever fully down, extracting and ejecting the fired cartridge case from the chamber.

### **▲WARNING**

**ALWAYS KEEP YOUR RIFLE SHOULDERED WHEN EJECTING AN EMPTY CARTRIDGE CASE. EJECTION IS UP AND SLIGHTLY TO THE RIGHT. IF YOU EJECT A CARTRIDGE CASE WITH THE RIFLE LOWERED AND THE ACTION DIRECTLY IN FRONT OF YOUR FACE, IT IS POSSIBLE THAT THE EJECTED CARTRIDGE CASE COULD STRIKE YOU IN THE FACE, OR STRIKE A BYSTANDER. FAILURE TO FOLLOW THIS WARNING COULD RESULT IN SERIOUS INJURY.**

When an empty cartridge case is correctly ejected it will fall to the ground in an area behind and to the right of the shooter.

6. Close the action by returning the finger lever upward. The closing of the action will transfer a new cartridge from the magazine to the chamber, leaving the hammer in the full-cock, ready-to-fire position.

If you wish to continue shooting, repeat steps 3-5. If you are finished shooting go immediately to step 7.

You may continue shooting until the magazine is empty, at which time you will need to either reload the magazine with cartridges (if shooting is imminent), or fully unload your rifle (if shooting is completed).

7. When firing is completed or when shooting is no longer imminent, immediately place the “safety” in the on safe position and move the hammer to the rebound position. Under no circumstances should you move on or continue to hunt with the hammer in the full-cock position or the “safety” in the off safe position.

## **▲WARNING**

**AFTER FIRING, OR WHEN SHOOTING IS NO LONGER IMMINENT, IMMEDIATELY PLACE THE “SAFETY” IN THE ON SAFE POSITION AND MOVE THE HAMMER TO THE REBOUND POSITION. FAILURE TO FOLLOW THESE WARNINGS COULD RESULT IN SERIOUS INJURY OR DEATH.**

## **UNLOADING**

---

## **▲WARNING**

**WHEN UNLOADING YOUR RIFLE ALWAYS PLACE THE “SAFETY” IN THE ON SAFE POSITION. KEEP THE MUZZLE POINTED IN A SAFE DIRECTION AND YOUR FINGERS AWAY FROM THE TRIGGER. FAILURE TO FOLLOW THESE WARNINGS COULD RESULT IN SERIOUS INJURY OR DEATH.**

**ALWAYS INSPECT THE CHAMBER, BARREL, FEED MECHANISM AND MAGAZINE CAREFULLY AFTER UNLOADING TO BE SURE ALL LIVE CARTRIDGES ARE CLEARED FROM THE FIREARM.**

Completely unloading your rifle during storage and other appropriate situations is essential to safe gun handling. The “safety” on the Model 1892 is of utmost importance during unloading. When the “safety” is in the on safe position, it allows you to cycle the action and eject loaded cartridges from the magazine with the hammer blocked and unable to strike the firing pin.

1. Place the “safety” in the on safe position.
2. Swing the finger lever completely downward. This will extract any cartridge from the chamber and eject it. Capture the cartridge and return the finger lever fully upward.
3. Continue to operate the finger lever in the same manner transferring all the remaining cartridges from the magazine to the chamber and then ejecting them out.
4. When cartridges no longer eject when you cycle the action, further ensure that no cartridges remain

**FIGURE 18**

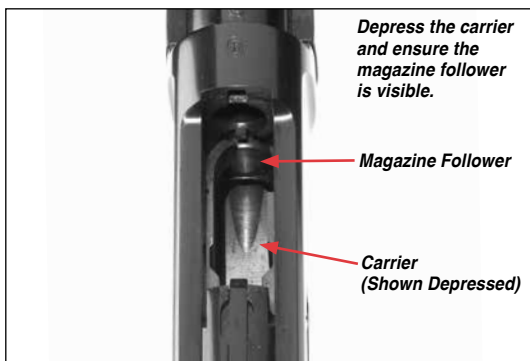

by opening the action, depressing the carrier and visually checking the chamber, feed mechanism and magazine follower to be certain that the rifle is completely unloaded (Figure 18, page 27). After the last live cartridge is moved out of the magazine and ejected, immediately lower the hammer to the rebound position as explained previously.

### SIGHT ADJUSTMENT

#### **⚠ WARNING**

**BEFORE ADJUSTING THE SIGHTS, PLACE THE "SAFETY" IN THE ON SAFE POSITION. OPEN THE ACTION AND MAKE CERTAIN YOUR RIFLE IS COMPLETELY UNLOADED. CLOSE THE ACTION AND MOVE THE HAMMER TO THE REBOUND POSITION. KEEP THE MUZZLE POINTED IN A SAFE DIRECTION. FAILURE TO FOLLOW THESE WARNINGS COULD RESULT IN SERIOUS INJURY OR DEATH.**

The Model 1892 is fitted with adjustable open sights. The proper procedure is to shoot a group with the sights set as they come from the factory (intermediate position on both elevation and windage), and then make incremental adjustments to move the sight blade and blade holder to position the group on your target.

**FIGURE 19**

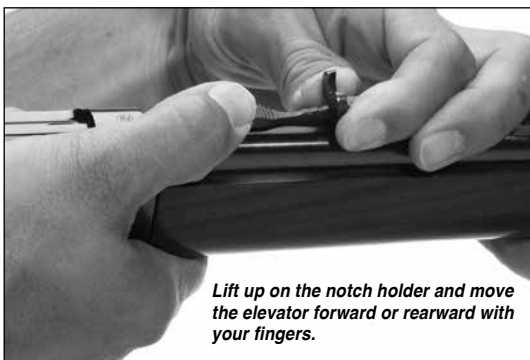

## UP OR DOWN ELEVATION ADJUSTMENTS

Adjusting elevation on most Model 1892 sights requires you to lift up the rear blade on your rifle's rear sight with your fingers and move the notched elevator either forward or backward (Figure 19, page 28).

To raise point of impact, use your fingers to lift up on the blade and slide the elevator rearward. Adjusting the sight to make your gun shoot lower is just the opposite, move the elevator forward.

- Move the rear sight blade and elevator up to shoot higher on the target.
- Move the rear sight blade and elevator down to shoot lower on the target.

## RIGHT OR LEFT WINDAGE ADJUSTMENTS

On most Model 1892 sights, the rear sight base is dovetailed in the rear of the barrel. To adjust for windage, gently move the rear sight base to the right or left by tapping the sight base at the dovetail using a wood or fiber dowel or hammer that will not mar the sight (Figure 20, page 29).

- Move the rear sight base to the right to shoot farther to the right on the target.
- Move the rear sight base to the left to shoot farther to the left on the target.

**FIGURE 20**

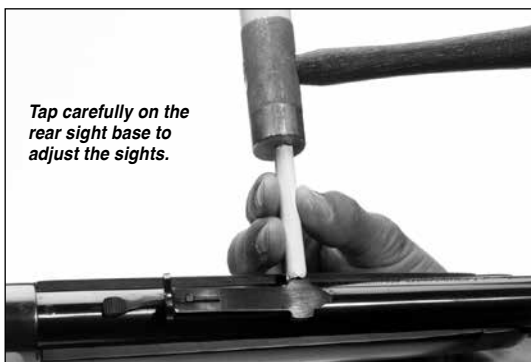

Care should be taken not to mar the finish or bend sight components when adjustments are made.

All sight adjustments are a matter of trial and error. Remember, it is usually necessary to adjust your sights when you change type or even brand of ammunition.

### **TAKEDOWN MODELS**

The Model 1892 rifle is also available as a takedown model. These rifles have a mechanism that allows you to separate the barrel/forearm half of the rifle from the receiver half of the rifle. The takedown design utilizes an interrupted thread system on the barrel extension and receiver, and a special mechanism on the end of the magazine tube which allows you to disengage the barrel from the receiver. For terminology related to the Model 1892 Takedown rifle refer to Figures 21, 22 and Figure 23 (page 30).

The full serial number of the rifle is located on the receiver half of the rifle, on the bottom of the receiver, toward the front. The last four digits of the number portion of the serial number are also on the receiver extension just forward of where it meets the receiver. Record the full serial number on the receiver at the front of this owner's manual for future reference.

**FIGURE 21**

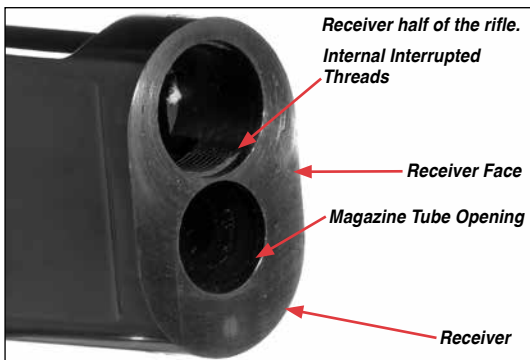

**FIGURE 22**

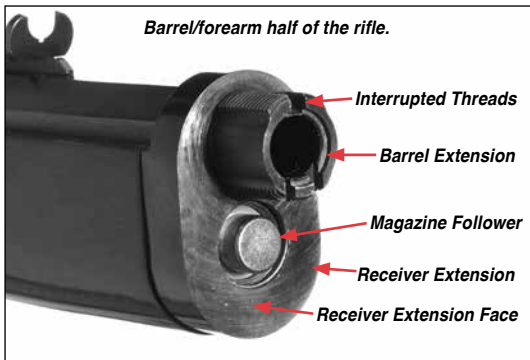

**FIGURE 23**

Takedown lever shown in the closed position.





## **NOTICE**

**THE BARREL/FOREARM HALF OF THE RIFLE MUST ONLY BE USED WITH THE RECEIVER HALF OF THE RIFLE IT WAS SOLD WITH. BARRELS ARE NOT INTERCHANGEABLE WITH ANY OTHER CURRENT OR OLDER MODEL 1892 RIFLE.**

### *TAKEDOWN PROCEDURE*

## **⚠ WARNING**

**BEFORE PERFORMING DISASSEMBLY PROCEDURES, PLACE THE "SAFETY" IN THE ON SAFE POSITION. COMPLETELY UNLOAD THE RIFLE BY REMOVING ALL CARTRIDGES FROM THE CHAMBER, MAGAZINE AND ACTION-FEED AREAS. KEEP THE MUZZLE POINTED IN A SAFE DIRECTION. FAILURE TO FOLLOW THESE WARNINGS COULD RESULT IN SERIOUS INJURY OR DEATH, AND CAUSE DAMAGE TO YOUR FIREARM.**

With the rifle fully assembled, use the following procedure to take it down into two parts.

1. Completely unload the rifle as explained previously.

## **NOTICE**

**THE RIFLE CANNOT BE TAKEN DOWN IF THERE IS A CARTRIDGE IN THE MAGAZINE. DAMAGE CAN OCCUR TO THE RIFLE IF YOU ATTEMPT TO TAKE DOWN THE RIFLE WITH A CARTRIDGE IN THE MAGAZINE.**

2. Open the action completely by working the finger lever completely downward.

## **NOTICE**

**THE RIFLE CANNOT BE TAKEN DOWN UNLESS THE ACTION IS OPEN. DAMAGE CAN OCCUR TO THE BOLT COMPONENTS IF YOU ATTEMPT TO TAKE DOWN THE RIFLE WITH THE ACTION CLOSED.**

**FIGURE 24**

*Pull the takedown lever completely outward.*



**FIGURE 25**

*Turn the takedown lever counterclockwise at least five turns as shown.*



3. Lift the takedown lever on the end of the magazine tube fully outward, away from the magazine (Figure 24, page 32).
4. Rotate the takedown lever counterclockwise at least five full turns to disengage the magazine tube and magazine follower from the receiver (Figure 25, page 32).
5. With one hand grasp the pistol grip of the rifle, and with the other hand grasp the barrel/forearm half of the rifle.
6. While securely holding the pistol grip, rotate the barrel/forearm half clockwise 90° to unlock the barrel/forearm from the receiver (Figure 26, page 33).

**FIGURE 26**



**FIGURE 27**



**NOTICE**

**IF THE BARREL/FOREARM WILL NOT ROTATE WITH RESPECT TO THE RECEIVER DO NOT APPLY EXTRA FORCE UNTIL YOU CONFIRM THE ACTION IS OPEN AND THE TAKEDOWN LEVER HAS BEEN TURNED SUFFICIENTLY TO DISENGAGE THE MAGAZINE TUBE AND MAGAZINE FOLLOWER FROM THE RECEIVER. APPLYING UNDUE FORCE WITH THE ACTION CLOSED COULD DAMAGE THE RIFLE.**

7. Carefully pull the barrel/forearm half of the rifle away from the receiver (Figure 27, page 33).

**FIGURE 28**

*Be certain the magazine tube and magazine follower are completely retracted into the receiver extension.*

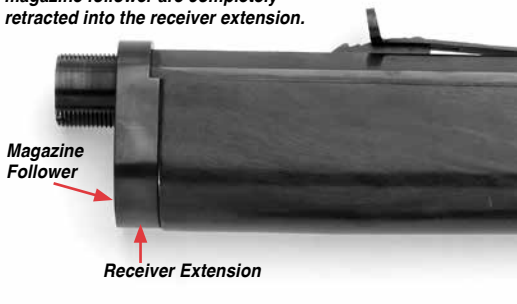

Your rifle is now taken down. To case or store the two halves of your rifle, return the finger lever to the closed position, return the takedown lever to the folded-down position flush with the bottom of the magazine, centered on the bottom of the magazine tube.

## ASSEMBLY PROCEDURE

### **▲WARNING**

**BEFORE PERFORMING ASSEMBLY PROCEDURES, PLACE THE "SAFETY" IN THE ON SAFE POSITION. COMPLETELY UNLOAD THE RIFLE BY REMOVING ALL CARTRIDGES FROM THE CHAMBER, MAGAZINE AND ACTION-FEED AREAS. KEEP THE MUZZLE POINTED IN A SAFE DIRECTION. FAILURE TO FOLLOW THESE WARNINGS COULD RESULT IN SERIOUS INJURY OR DEATH, AND CAUSE DAMAGE TO YOUR FIREARM.**

Perform the following procedure to assemble the rifle.

1. Open the action completely by working the finger lever completely downward.

### **NOTICE**

**THE RIFLE CANNOT BE ASSEMBLED UNLESS THE ACTION IS OPEN. DAMAGE CAN OCCUR TO THE BOLT**

**FIGURE 29**



### **COMPONENTS IF YOU ATTEMPT TO ASSEMBLE THE RIFLE WITH THE ACTION CLOSED.**

2. Lift the takedown lever on the end of the magazine tube fully outward, away from the magazine. Make certain the magazine tube and magazine follower are not protruding from the receiver extension (Figure 28, page 34) by rotating the takedown lever counterclockwise.
3. With one hand grasp the pistol grip of the rifle, and with the other hand grasp the barrel/forearm half of the rifle.
4. While securely holding the pistol grip, position the barrel/forearm half of the rifle 90° to the left of the receiver (Figure 29, page 35).
5. Insert the threaded barrel extension into the receiver. Verify the receiver extension and receiver are lightly making contact. The barrel extension is now fully inserted.
6. With the barrel extension fully inserted, rotate the barrel/forearm half clockwise 90° to secure the halves of the rifle. Very little force should be required to rotate the barrel/receiver into position.

**FIGURE 30**

*Completely tighten the locking lever and return it to the folded position under the magazine tube.*



## **NOTICE**

**IF THE BARREL/FOREARM WILL NOT ROTATE WITH RESPECT TO THE RECEIVER DO NOT APPLY EXTRA FORCE UNTIL YOU CONFIRM THE ACTION IS OPEN AND THE TAKEDOWN LEVER HAS BEEN TURNED SUFFICIENTLY TO ALLOW THE MAGAZINE TUBE AND MAGAZINE FOLLOWER TO CLEAR THE RECEIVER. APPLYING UNDUE FORCE COULD DAMAGE THE RIFLE.**

If the barrel/forearm will still not rotate, ensure there is no foreign matter (dirt, grit, etc.) between the faces on the receiver extension and receiver. Clean both surfaces and lightly oil them.

7. Once the barrel/forearm are rotated into position, extend the takedown lever and secure the magazine tube into the receiver by turning the takedown lever clockwise. Tighten the magazine tube until it is snug. Do not overtighten.
8. When the takedown lever is secured, fold the takedown lever over until it lays along the bottom of the magazine tube (Figure 30, page 36). If the takedown lever is not centered on the magazine tube, rotate it into alignment. Your rifle is now assembled.

## CLEANING AND MAINTENANCE SUGGESTIONS

### **▲WARNING**

**BEFORE PERFORMING CLEANING PROCEDURES, PLACE THE “SAFETY” IN THE ON SAFE POSITION. OPEN THE ACTION AND MAKE CERTAIN YOUR RIFLE IS COMPLETELY UNLOADED. KEEP THE MUZZLE POINTED IN A SAFE DIRECTION. FAILURE TO FOLLOW THESE WARNINGS COULD RESULT IN SERIOUS INJURY OR DEATH.**

### **▲WARNING**

**WEAR EYE PROTECTION WHEN DISASSEMBLING AND CLEANING YOUR RIFLE TO PREVENT SPRINGS, SPRING-LOADED PARTS, SOLVENTS OR OTHER AGENTS FROM CONTACTING YOUR EYES, RESULTING IN INJURY.**

### **▲WARNING**

**KEEP ALL AMMUNITION AWAY FROM THE CLEANING AREA. NEVER TEST THE MECHANICAL FUNCTION OF YOUR RIFLE WITH LIVE AMMUNITION. FAILURE TO FOLLOW THESE WARNINGS COULD RESULT IN SERIOUS INJURY OR DEATH.**

### CLEANING PROCEDURES

Your Model 1892 will function better and more reliably over a longer period of time if it is properly maintained and kept clean. Clean your firearm after each day of shooting and more often if it becomes excessively dirty. A minimum cleaning includes wiping down the action and oiling key parts. Regular maintenance will also include cleaning the barrel.

If you encounter a function problem be sure to give your firearm a thorough cleaning to see if it solves the problem before seeking the services of a Winchester Repeating Arms Authorized Repair Center or our Service Facility in Arnold, Missouri, or a qualified gunsmith.

1. Open the action by completely lowering the lever.

2. Use a cleaning rod with a tip and patch large enough for a snug fit in the bore. Insert the rod and patch into the barrel at the muzzle end and run it back and forth several times. Care should be exercised to ensure that neither the cleaning rod nor the handle strikes the crown of the muzzle, as damage to this area can adversely affect the accuracy of the rifle. A muzzle protector can be purchased separately from your local firearms dealer to help protect the muzzle crown while cleaning the barrel of your rifle. If your rifle is a takedown model you may disassemble it, as explained on pages 29-34, for cleaning and maintenance.
3. Inspect the chamber and bore for brass, copper and powder fouling. A normal amount of powder residue can be expected and is not serious. It can usually be removed by repeating step 2, using a patch saturated with solvent. If, or when, fouling should become heavy, it can be removed with a brass bore brush. Dip or spray the brush with solvent and scrub the chamber and bore until the fouling is removed. To prevent brass bristles from breaking off, the brush should be pushed completely through the bore before being withdrawn. Your rifle will operate more smoothly and reliably with a clean bore and chamber.
4. To maintain the utmost accuracy of your rifle it is recommended you clean the bore with a copper solvent. Modern bullet jackets are made mainly of copper and zinc. Copper and zinc residue sticks to the bore and require more frequent cleaning. Swab the bore of your rifle with a good copper solvent using the product manufacturer's recommended procedure.
5. After fouling has been removed, wipe the bore dry. Then pass a lightly oiled patch through the barrel for preservation. A fine, light gun oil is recommended. The barrel and action should be inspected thoroughly to be certain no cleaning patches have been inadvertently left in them.



6. The interior of the receiver and the bolt should periodically be wiped with a clean rag. Any dried oil in these areas or on the magazine follower should be removed. Follow this cleaning by applying a very light film of oil on the affected parts.
7. Lightly oil your firearm at the points described under “Initial Cleaning and Oiling” on pages 14-15. Ordinary good judgment will, of course, indicate that the metal of the gun should receive a light film of oil any time the rifle has been exposed to weather or handling. Remember, the polished, finely fitted surfaces of the receiver and action mechanisms must always have a thin film of oil. Make sure that the surfaces of the breech block, lever components and feed mechanism parts are especially clean and lightly oiled with a high quality gun oil.

If your rifle is a takedown model and was taken down for cleaning and maintenance, you may now assemble it as explained on pages 34-36.

### **NOTICE**

**DO NOT POUR LARGE QUANTITIES OF OIL INTO THE RECEIVER OR OTHER PARTS. IT CAN DRAIN DOWN TO THE WOOD AND SOFTEN IT, CAUSING PERMANENT DAMAGE AND LOOSENING OF THE STOCK.**

8. Wipe all exposed metal surfaces of the receiver, forearm and barrel with a clean rag. Finger marks should be removed because they provide a place where moisture can accumulate. Any dried oil in the receiver area should also be removed.
9. Inspect the barrel and chamber. Make certain that no patches have been inadvertently left in them. Remove any that remain.
10. The wood surfaces of your rifle can also be wiped lightly with fine oil, or you can apply a quality wood or furniture polish to the stock and forearm. Using one of these methods (not both), will enhance the beauty and durability of your rifle.

## ADDITIONAL SUGGESTIONS

- When transporting your rifle, store it in a quality protective case to prevent scratches and dents. Store your rifle in a cool, dry place to prevent corrosion. Store your rifle and ammunition separately, away from children.
- After extended periods of heavy use, your gun should be taken to a qualified gunsmith to have the action disassembled for professional cleaning and lubrication.

### **NOTICE**

**NEVER ATTEMPT TO TAKE YOUR FIREARM APART FURTHER THAN EXPLAINED IN THIS OWNER'S MANUAL. YOUR FIREARM IS A SPECIALIZED, FINELY FITTED MECHANISM. YOU MAY PERMANENTLY DAMAGE IT BY ATTEMPTING TO DISASSEMBLE THE INNER MECHANISM. IF FURTHER DISASSEMBLY FOR SERVICE OR CLEANING IS REQUIRED, TAKE YOUR FIREARM TO A QUALIFIED GUNSMITH, OR CONTACT OUR ARNOLD, MISSOURI SERVICE FACILITY AS EXPLAINED ON PAGES 40 AND 41 UNDER "PARTS, SERVICE, REPAIR AND QUESTIONS."**

## PARTS, SERVICE, REPAIR AND QUESTIONS

If your Winchester firearm should require service or repair, we suggest first contacting a Winchester Repeating Arms Authorized Repair Center. To locate an Authorized Repair Center visit [winchesterguns.com](http://winchesterguns.com), contact our customer service department or ask your local Winchester Repeating Arms dealer. You may also send your firearm to the Winchester Repeating Arms Service Facility in Arnold, Missouri. In order to avoid service delays, do not send your firearm directly to our service facility without authorization from one of our service specialists.

Parts listings, a list of Authorized Repair Centers, service procedures, service/repair form and general product information are on the web at [winchesterguns.com](http://winchesterguns.com).

# **WINCHESTER**<sup>®</sup>

REPEATING ARMS

When returning your firearm for servicing, you must do the following:

1. Be sure it is completely unloaded.
2. Remove any optics, optic mounts or other accessories.
3. Package it securely in a cardboard container.
4. Enclose the service/repair form available at [winchesterguns.com](http://winchesterguns.com) or a letter that clearly describes the trouble experienced, the ammunition used and the repairs desired. Also include your name, email address (if possible) and a daytime phone number where you can be reached.
5. Never return ammunition with your firearm. It is against postal and most commerce regulations.

## **PARTS, SERVICE, REPAIR STATUS AND TECHNICAL QUESTIONS**

### **Winchester Repeating Arms**

#### **Parts and Service**

3005 Arnold Tenbrook Road  
Arnold, MO 63010-9406  
(800) 322-4626

## **GENERAL PRODUCT AND HISTORICAL QUESTIONS**

### **Winchester Repeating Arms**

#### **Customer Service**

275 Winchester Avenue  
Morgan, UT 84050-9333  
(800) 945-5237  
[customersupport@winchesterguns.com](mailto:customersupport@winchesterguns.com)

#### **▲WARNING**

**PARTS ARE MADE FOR WINCHESTER BRAND FIREARMS MANUFACTURED BY OR FOR WINCHESTER REPEATING ARMS, AND SHOULD NOT BE USED IN OTHER FIREARMS, EVEN THOUGH MODELS MAY BE SIMILAR. IMPROPERLY FITTED PARTS MAY BE DANGEROUS. FAILURE TO FOLLOW THIS WARNING MAY CAUSE INJURY OR DEATH AND CAUSE DAMAGE TO YOUR FIREARM.**

## **WEBSITE INFORMATION**

---

An information resource for Winchester Repeating Arms can be found online at [winchesterguns.com](http://winchesterguns.com).

- List of Authorized Repair Centers.
- Customer Service information.
- Firearm Service/Repair Form.
- Answers to many technical and historical questions.
- Links to helpful sites.

**WINCHESTER®**

REPEATING ARMS

**NOTES**

---



Winchester Repeating Arms  
275 Winchester Avenue  
Morgan, UT 84050-9333  
(800) 945-5237  
[winchesterguns.com](http://winchesterguns.com)

Winchester is a registered trademark of Olin Corporation.

AO2010/20309