

# Owner's Manual

Instruction Book for:  
MODEL M770™ M710™ M715™  
BOLT ACTION RIFLES



## Remington

### IMPORTANT!

This manual contains operating, care, and maintenance instructions. To assure safe operation, any user of this firearm must read and understand this manual before using the firearm. Failure to follow the instructions and heed the warnings in this manual can cause property damage, personal injury, and/or death.

This manual should always accompany this firearm, and be transferred with it upon change of ownership.

**WARNING** Keep this firearm out of the reach of children, unauthorized individuals, and others unfamiliar with safe handling of firearms.



PAGE 2	.....	THE TEN COMMANDMENTS OF IREARM SAFETY
PAGE 7	.....	IMPORTANT PARTS OF THE IREARM
PAGE 11	.....	TO LOAD THE IREARM
PAGE 13	.....	HOW TO UNLOAD THE IREARM
PAGE 1	.....	IDENTIFICATION AND MAINTENANCE
PAGE 19	.....	HOW TO FUNCTION TEST THE IREARM
PAGE 23	.....	PARTS LIST
PAGE 2	.....	HOW TO OBTAIN PARTS AND SERVICE

## A Tradition of Performance and Safety.

In 1816 Eliphalet Remington was confident he could make a flintlock that was as good or better than any he could buy. His confidence was well founded. The barrel he handcrafted set a new standard for firearm accuracy and spawned generations of products that have made Remington® Arms America's leading gunmaker. While performance and style are certainly hallmarks of Remington firearms, one factor ultimately drives their performance. Safety. Eliphalet Remington never lost sight of the fact that his rifles were potentially lethal and could kill someone if handled improperly. And after more than 190+ years the same holds true for any firearm, including your new Remington. Eliphalet Remington's first flintlock launched a proud tradition of accuracy and responsibility.



*Eliphalet Remington's first flintlock launched a proud tradition of accuracy & responsibility*

## Safety is Critical to Performance.

A superbly crafted firearm is only as good as the hands that hold it. You can never be too careful. Shooting accidents are often caused by careless oversights such as failing to control the direction of the muzzle, failing to fully engage the safety, leaving ammunition in the chamber or using improper loads. These oversights can result in the destruction of life, limb or property. There's no calling back a bullet once it's been fired, so it's critical that you know the principles of safe firearm handling and storage before you ever take your new Remington firearm out of the box.

The proper use and performance of your firearm depends on correct assembly and maintenance, so it's critical that you familiarize yourself with the information in this instruction book. Even if you're a veteran shooter with a collection of Remington firearms, take the time to read this literature. Not all firearms are the same. That means the first step in safe handling is to learn the features and requirements of your new Remington.

## THE TEN COMMANDMENTS OF FIREARM SAFETY

The Ten Commandments of Firearm Safety should be etched in your memory forever. Let them govern your action wherever and whenever you're involved with firearms. In the field. On the range. Or in your home. Please take the time to review and understand these rules.

### 1st C O M M A N D M E N T

#### **ALWAYS KEEP THE MUZZLE POINTED IN A SAFE DIRECTION.**

*This is the most important firearm safety rule.* A safe direction is one in which an accidental discharge will not cause injury to yourself or others. Never allow your firearm to point at anything you don't intend to shoot. Be especially careful when you're loading or unloading. Treat every firearm as if it were loaded. And make it a habit to know where the muzzle is pointed at all times, even when your firearm is un-loaded. No one will be injured by an accidental discharge if you keep your firearm pointed in a safe direction. It's as simple as that.

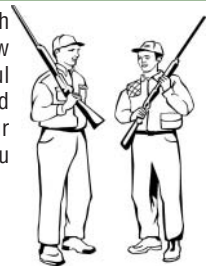

### 2nd C O M M A N D M E N T

#### **Firearms should be Unloaded When Not Actually in Use.**

*Load your firearm only* when you're in the field or on the target range and ready to fire. Never let a loaded firearm out of your sight or out of your hands. Unload it as soon as you're finished shooting - before you bring it into your car, camp or home. Remember, unloading your firearm means unloading it completely, so there is no ammunition in the chamber or in the magazine. Before handling a firearm or passing it to someone else, visually check the chamber, receiver and magazine to be certain they do not contain ammunition. Always keep the firearm's action open when not in use. Never assume a firearm is unloaded even if you were the last person to use it. Always check for yourself.

- *Let common sense rule* when you carry a loaded firearm. If you're in a situation that could risk accidental discharge - such as crossing a fence, wading through a stream or climbing a tree - always unload your firearm. Never pull or push a loaded firearm toward yourself or another person. Never carry a loaded firearm in a scabbard, detached holster or gun case.



*Firearms should be stored in a secure place where children cannot access them. A gun safe is an ideal way to secure your firearm*

- *Certain firearms* (including some Remington® rifles and shotguns) are equipped with internal security devices to prevent unauthorized use. In addition, some firearms owners use external devices, such as cable locks and trigger blocks, for the same purpose. Even if you use such a device, you should still keep your firearm unloaded when stored or not in use. And using internal or external devices cannot substitute, however, for securing your firearms and ammunition in a separate, locked location.

- *Safe storage* of firearms is just as critical as safe handling. Never store firearms loaded. Be sure to keep your firearms in a secure place where unauthorized persons cannot get their hands on them without your knowledge.

- *Take special care* if there are children around. Children are fascinated by firearms. It's a natural curiosity that can have tragic consequences when not properly supervised. Store your firearms in a locked gun safe or some other location that physically bars a child from gaining access.

- *Ammunition* should be stored and locked in a location separate from your firearm. Never leave an unsecured firearm or ammunition in a closet, dresser drawer or under the bed. Remember, it is your responsibility to make sure that children and others unfamiliar with firearms cannot get access to your firearm and ammunition.

### 3rd C O M M A N D M E N T

#### DON'T RELY ON YOUR FIREARM'S SAFETY

*Treat every Firearm* as if it can fire at any time, whether or not there's pressure on the trigger. Your firearm has been carefully designed to maximize performance and safety. However, because a firearm's safety is a mechanical device, it could fail.

*Human error* is a more likely reason for a firearm safety to fail. By mistake, you may think the safety is on when it really isn't. Or the safety may have been disengaged without your knowledge. Or you could think your firearm is unloaded when there's actually a cartridge or shell in it. A mechanical safety is not a substitute for common sense. It's merely a supplement to your proper handling of a firearm.

*Never touch* the trigger on a firearm until you are ready to shoot. Keep your fingers away from the trigger when you're loading or unloading. And don't pull the trigger when the safety is engaged or positioned between safe and fire.

*Before using your firearm*, read this instruction book to understand the exact location and operation of your firearm's safety. Even when the safety is on, maintain control of your loaded firearm and control the direction of the muzzle. In other words, don't rely on your safety to justify careless handling. If your firearm's internal mechanisms are broken or have been altered, your firearm may fire even when the safety is on. Remember, you and your safe firearm handling practices are your firearm's best safety.

### 4th C O M M A N D M E N T

#### BE SURE OF YOUR TARGET AND WHAT'S BEYOND IT.



You can't stop a shot in mid-air, so never fire unless you know exactly where your shot is going and what it will strike.

Never fire at a sound, a movement or a patch of color. A hunter in camouflage can easily be mistaken for a target by an impulsive shooter. Before you pull the trigger be absolutely sure of your target and what's behind it. Make sure the shot has a backstop such as

a hillside or dense material like sand. Remember, bullets can travel great distances with tremendous velocity. Know how far your shot will go if you miss your target or the bullet ricochets.



# 5th C O M M A N D M E N T

## Use Proper Ammunition

Every firearm is designed to use a certain caliber or gauge of ammunition. Using the wrong ammunition, mixing ammunition or using improperly reloaded ammunition can cause serious personal injury or death. And it only takes one cartridge or shotshell of the incorrect caliber or gauge, or which has been improperly reloaded, to destroy your firearm. It's your responsibility to make sure the ammunition you use exactly matches the caliber or gauge of your firearm. Refer to this instruction book to find out the specific requirements of your firearm. Always read and heed the instructions on ammunition boxes.

*Confusing shells* or cartridges can cause serious personal injury or death and destroy your firearm. Examine your shells or cartridges closely and use only the precise caliber or gauge for your specific firearm. For example, suppose you accidentally loaded a 20 ga. shell into a 12 ga. shotgun. Because the 20 ga. shell is too small for the chamber, the 20 ga. shell could travel down the barrel and get lodged in the bore. If you then loaded a standard 12 ga. shell behind it and fired, the 12 ga. shot will slam into the lodged 20 ga. shell and may cause the barrel to explode right in your hand. This is commonly called a 12/20 burst, and it can kill you.

*Check all ammunition* before you load it to make sure it matches your firearm's requirements. Every Remington® cartridge and shell is head-stamped with its caliber or gauge for easy identification. Likewise, you'll find the caliber or gauge of your new Remington firearm imprinted on the barrel.

### Reloading Requires Extra Diligence.

*If you're an ammunition reloader*, you are responsible for personally assuring that the loads and components of your reloaded ammunition meet your firearm's factory-tested standards. Never use ammunition, which has been reloaded by someone else!

*Many shooters handload* as a hobby or to save money on commercial, factory-made ammunition. However, it requires a thorough knowledge of reloading procedures and a deep respect for the explosive potential of gunpowder.

*Firearms are designed*, manufactured and proof-tested to standards based on factory-loaded ammunition. Handloaded or reloaded ammunition that deviates, either intentionally or accidentally, from load or component recommendations can be very dangerous.

Reloaders must observe all possible safety precautions and practices related to the proper handling of explosives. Whether you're a seasoned reloader or just starting out, you should study the subject, watch reloading demonstrations and talk to experienced reloaders.

*The first rule of reloading* is to always follow the manufacturer's instructions for the components you're using. They'll tell you to follow certain guidelines. Namely:

1. Don't mix or substitute powders or primers.
2. Don't use unknown or substandard components.
3. Use only suitable components that have been factory-tested by reputable ammunition, powder and bullet manufacturers.
4. Always be sure to use the manufacturer's recommended recipe when reloading.

*Not following these guidelines* could result in severe injury to yourself or severe damage to your firearm. Dangerously high pressure and explosions can result from an overcharge of powder or other deviations from established reloading guidelines. Be very careful. The process of reloading exposes you to environmentally hazardous material. Lead, which is known to cause cancer and birth defects, is the most common substance in bullets and shot. It is important to handle lead bullets and shot with extreme care. Work only in a well-ventilated area and always wash your hands after exposure and before eating. Never smoke while reloading.

*Primers and powders* are also highly toxic and flammable. So after reloading be sure to clean up all materials from your work area. Don't leave primer or powder spills anywhere on the floor or bench top. Dispose of all waste material in accordance with the manufacturer's recommendations.

*Finally, when reloading* or handloading concentrate on what you're doing at all times. Do not be distracted by talking to others, listening to the radio or watching TV while reloading. Never reload after consuming alcoholic beverages or drugs of any kind. You are working with extremely hazardous materials and you can't risk even a few seconds of distraction. Remember, if you reload, you are the ammunition manufacturer and you are responsible for the performance and safety of your reloaded ammunition.





## 6th C O M M A N D M E N T

**IF YOUR FIREARM FAILS TO FIRE WHEN THE TRIGGER IS PULLED, HANDLE WITH CARE.**

If for some reason the ammunition doesn't fire when you pull the trigger, stop and remember the 1st Commandment of Firearm Safety - always keep the muzzle pointed in a safe direction. Keep your face away from the breech, then put the safety on, carefully open the action, unload the firearm and dispose of the cartridge safely. Remember that anytime there's a shell in the chamber, your firearm is loaded and ready to use. Even if you tried to shoot and your firearm didn't fire, treat your firearm as if it could still discharge.



## 7th C O M M A N D M E N T

**ALWAYS WEAR EYE AND EAR PROTECTION WHEN SHOOTING.**

Your sight and hearing risk injury from shooting and should be protected at all times. Wear protective shooting glasses to guard against falling shot, clay target chips, powder residue, ruptured cartridge cases and even twigs and branches in the field. Also be sure to wear eye protection when you're disassembling or cleaning a firearm so that tensioned parts (like springs) and cleaning solvents don't come in contact with your eyes. Continued exposure to shooting noise can permanently damage your hearing. On the range, where shooting volume is the loudest, be sure to use the maximum protection of a headset. Learn to use ear protection at all times.



## 8th C O M M A N D M E N T

**BE SURE THE BARREL IS CLEAR OF OBSTRUCTIONS BEFORE SHOOTING.**

Before loading your firearm, open the action and make sure there's no ammunition in the chamber or magazine. Check the barrel for any obstructions or debris. Even a small amount of snow, mud, excess lubricant or grease in the bore can dangerously increase pressure and cause the barrel to bulge or burst when firing. Use a cleaning rod and patch to wipe away anti-rust compounds or any other residues or obstructions in the barrel. Never try to shoot out an obstruction by loading another shell and firing!

When firing, rely on your instincts. If the noise or recoil of your firearm seems weak, stop everything, unload your firearm and be sure nothing is lodged in the barrel. Remember the 12/20 burst? That's what can happen when the barrel is obstructed. Always be sure you're using the correct ammunition in your firearm and that it's free of obstructions.



## 9th C O M M A N D M E N T

**DON'T ALTER OR MODIFY YOUR FIREARM AND HAVE IT SERVICED REGULARLY.**

Your firearm has been designed to operate according to certain factory specifications. You'll jeopardize your safety and that of others around you by attempting to alter its trigger, mechanical safety or other mechanisms. So never alter or modify your firearm in any way.



Like any mechanical device, a firearm is subject to wear. It must be maintained and periodically serviced to assure optimum safety and performance. Only a qualified service facility should service, repair or modify your Remington firearm. Consult your instruction book for instructions on how to send your firearm to the factory or for the location of the nearest Remington authorized repair station.

Proper cleaning and lubrication are also important to firearm maintenance and are necessary to assure accuracy, safety and reliability. Before cleaning, always make sure that your firearm is completely unloaded. And

always clean the barrel from the chamber end to the muzzle when possible.

Make it a practice to clean your bore every time you're going to shoot. Be sure to clean your entire firearm before and after long-term storage and no less than once a year. It's also important to clean your firearm whenever it's been exposed to adverse conditions such as rain, dirt, mud, snow, sleet or saltwater.

For safe and dependable operation of your firearm, all parts of your firearm must be properly cleaned and lubricated. Periodically inspect the internal workings of your firearm to be sure they're clean and free of rust, unwanted dirt and debris.

Use recommended lubricants on your firearm and do not over-lubricate. Excessive use of a non-recommended lubricant could adversely affect the function and safe operation of your firearm. Remember, you are responsible for the proper care and maintenance of your firearm. Failure to properly maintain your firearm cannot only damage or ruin your firearm, it can expose you and others to unnecessary risks of personal injury or death.

Remington® has a wide range of firearm care products and resources for best results when cleaning your firearm. Everything from solvents and lubricants to rods and patches. They're all available from your Remington dealer.

## 10th C O M M A N D M E N T

### LEARN THE MECHANICS AND HANDLING CHARACTERISTICS OF YOUR FIREARM.

Not all firearms are alike. They have different mechanical characteristics that dictate how you should carry and handle them. Anyone who plans to use a firearm should first become totally familiar with the type of firearm it is and the safe handling procedures for loading, unloading, carrying, shooting and storing it.

Before you even unpack your new Remington firearm, read this instruction book from cover to cover and familiarize yourself with the different component parts of the firearm. Then read, understand and follow the Ten Commandments of Firearm Safety in this manual.

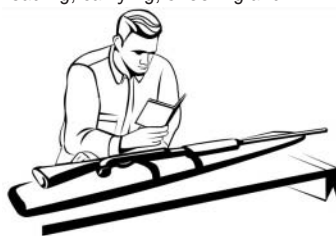

**WARNING!** Discharging firearms in poorly ventilated areas, cleaning firearms or handling ammunition may result in exposure to lead, a substance known to cause birth defects, reproductive harm, cancer and other serious physical injury. Have adequate ventilation at all times. Wash hands thoroughly after exposure.

### **SHOOT SOBER!!**

There's one other rule that must be followed when handling firearms. In fact, respect for this rule is necessary in order to effectively practice the Ten Commandments of Firearm Safety. The rule is: SHOOT SOBER! Firearms and alcohol or drugs make a deadly combination. Never consume anything that would mildly impair your judgment or physical coordination when you're using a firearm. A staggering percentage of the shooting accidents that occur every year involve alcohol or drugs. Be smart. Always shoot sober and stay alive.

**WARNING!** Failure to follow any of these safety rules may cause personal injury or death to the shooter or bystander and damage to property. Do not use a firearm until you fully understand and practice the Ten Commandments of Firearm Safety. If you have any questions about the safe use of a Remington firearm, write to us at Remington Arms Company, LLC Consumer Service, P.O. Box 700, Madison, NC 27025-0700, or call us at 1-800-243-9700.

### **DON'T KEEP THIS TO YOURSELF.**

Now that you're a firearm owner you have the obligation to help ensure that shooting sports are safe for everyone - participants and bystanders alike. You can do that by practicing these principles of firearm safety and passing them on to others - especially new shooters. Set an example for beginners. Be a guide to their safe entry into the exciting world of shooting sports. Invest your time and patience for the love of the sport and for its future. After all, it's your love of the sport that led you to buy a new Remington.

Firearm ownership is a right and privilege. It's a right guaranteed in this nation's Constitution. It's a privilege, which carries with it a personal responsibility to use your firearm in a way which will ensure your safety and the safety of others. The preservation of this right and privilege depends on the personal commitment of you and your fellow shooters to the safe and responsible use of firearms. Let the Ten Commandments of Firearm Safety outlined in the book guide you at all times. Teach and promote these rules whenever you can. Remember, firearm safety depends on you! That's the only way to really enjoy your new Remington firearm and to preserve sport shooting as we know it today.

# Remington® Model 710™, 715™ 770™ Bolt Action Rifles

*Congratulations on your choice of a Remington®. With proper care, it should give you many years of dependable use and enjoyment. For best results, we recommend that you use Remington Ammunition - the ammunition used in factory testing your firearm against our rigorous function and performance standards.*

**PICTURE 1** This picture shows the main parts of a REMINGTON® Bolt Action Rifle. The picture will aid in understanding the instructions.

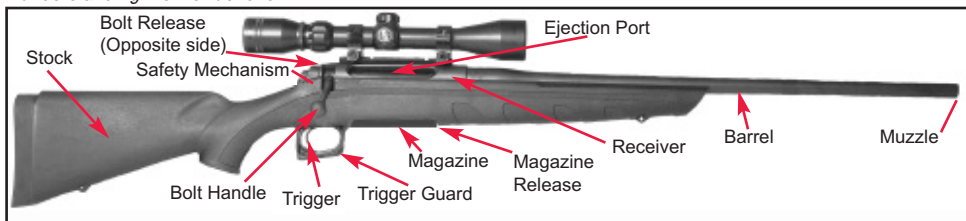

## General Operation

All Remington® centerfire bolt actuated rifles operate the same. The firearm is capable of firing multiple shots after each pull of the trigger and cycle of the bolt. At the start of the firing cycle after the trigger has been pulled, a cartridge has been discharged, and the safety engaged; the action is unlocked and the firing pin is cocked by rotating the bolt handle upward. As the bolt moves rearward, the spent cartridge case is pulled from the chamber. When the spent cartridge clears the chamber the cartridge is expelled from the firearm through the ejection port. As the bolt moves forward a new cartridge is stripped from the magazine and is placed into the chamber. The cycle is completed by rotating the bolt fully downward, locking the bolt and cartridge into the firing position.

## Important Parts of the Firearm

### Serial Number and Cartridge Designation:

The serial number is located on the shooter's left side of the receiver. See Picture 2.

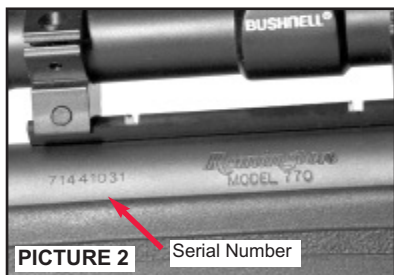

Specifications for the correct caliber and cartridge intended for use in your firearm is located on the shooter's left side of the barrel. See Picture 3

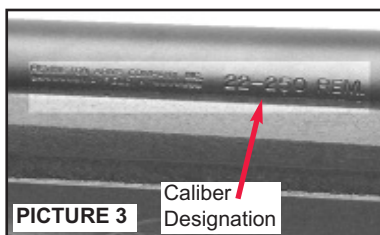

**WARNING!** Only use the specified cartridge type and caliber of ammunition specified for your firearm as designated on the barrel. See "To Load Your Firearm", page 11.

### The Safety Mechanism

The manual safety mechanism of your bolt action firearm provides protection against accidental or unintentional discharge under normal usage when properly engaged and in good working order.

This safety mechanism is not a substitute for following the rules of safe firearm handling. The safety mechanism lifts the sear and blocks the trigger, preventing the trigger from being pulled when fully engaged in the "S" or "SAFE" position.

The safety mechanism is located on the shooter's right towards the rear of the receiver. To engage the safety mechanism, pull the safety lever fully to the rear toward the "S" position until the safety arm stops. See Picture 4.

PICTURE 4



*Do not touch the trigger while moving the safety mechanism. Your fingers and all other objects should be kept outside of the trigger guard and away from the trigger until you are actually ready to FIRE.*

*Never attempt to pull the trigger when the Safety Mechanism is activated in the "S" or "SAFE" position.*

**WARNING!** The firearm will fire when the trigger is pulled and the *safety mechanism* is OFF or in the "F" or "FIRE" position.

*Even when the safety is engaged in the "S" or "SAFE" position, careless handling can cause the firearm to discharge. See the "Ten Commandments of Firearm Safety", on page 2.*

**WARNING!** Do not alter, modify, bypass, or render the safety features inoperative.

*Always engage the safety mechanism by moving the safety lever fully rearward before handling, loading or unloading the firearm.*

When you are ready to FIRE the firearm, disengage the Safety Mechanism by pushing the safety arm forward to the "FIRE" position, marked with a "F". You have now disengaged the Safety Mechanism and the firearm is ready to FIRE. See Picture 5.

## The Locking Device

This firearm was originally sold with a key-operated locking device or an integrated security system (ISS) to assist the owner in protecting against unauthorized use. These are storage locking devices. The firearm should be completely unloaded when stored or not in use.

**These locking devices DO NOT eliminate the need for safe firearm handling and storage, including keeping this and every firearm unloaded and locked in a secure place when not in use. Read and follow these and other safety rules in this instruction manual. Failure to read, understand, and obey these rules can result in serious personal injury or death. See the "Ten Commandments of Firearm Safety", on page 2.**

*Keep your locking device engaged when your firearm is not in use. Keep the keys in a secure place, inaccessible to others. DO NOT leave your keys or any ammunition with your firearm, which should be kept unloaded and locked in a safe place.*

To secure your firearm with an external locking device, See instructions provided in packaging.

PICTURE 5

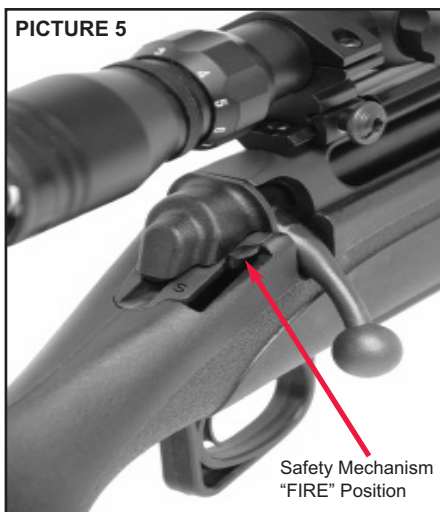



## The Integrated Security System

Some 710™ Models are equipped with an integrated security system (ISS). When activated the bolt can not be closed in the firing position.

The ISS is located on the left side of the bolt assembly in the bolt plug. See Picture 6.

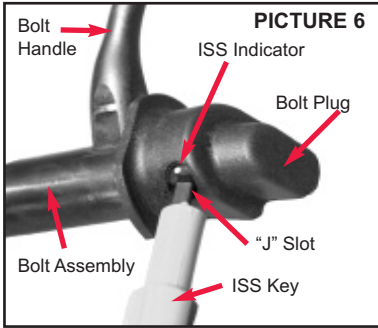

The "J" shaped slot is the key hole for engaging and disengaging the security system. The red and white indicator dots indicates whether the security system is disengaged (Red) or engaged (White). View the indicator dots from the top of the bolt assembly.

### To Engage the Integrated Security System:

1. Always keep the firearm pointed in a safe direction.
2. Verify the firearm is unload. See instructions "How to Unload the Firearm" on page 13.
3. The bolt must be installed in the firearm before engaging the Integrated Security System. See instructions "To Install the Bolt Assembly" on page 9.
4. Slide the bolt half way in the receiver.

**WARNING!** Do not attempt to engage the Integrated Security System when the bolt is closed and locked in the firing position.

5. Push the key fully into the "J" slot.
6. Turn the key clockwise until it stops and white indicator (engaged) dot is visible.
7. Remove the key by pulling it outward. **The system is now engaged. The bolt CANNOT be locked into the firing position.**

### To Disengage the Integrated Security System (ISS):

1. Always keep the firearm pointed in a safe direction.
2. With the white indicator dot visible, insert key until it stops.
3. Disengage the system by turning the key counter-clockwise until it stops and the red indicator (disengaged) dot is visible.
4. Remove the key by pulling outward. **The system is now disengaged. The bolt assembly CAN be locked in the firing position.**

*While operating the integrated security system, NEVER use excessive force to turn the key. If the key will not turn freely, contact a Remington® Authorized Repair Center.*

*If you lose the key, DO NOT attempt to disengage the security system using a foreign object. This will damage your firearm. Contact your Remington Authorized Repair Center for a replacement key. See page 24 for instructions to locate the nearest Authorized Repair Center.*

### To Install the Bolt Assembly:

1. Always keep the firearm pointed in a safe direction.
2. Engage the safety mechanism by moving the safety arm fully rearward to the "SAFE" or "S" position.
3. Before inserting the bolt assembly into the receiver, make sure the firing pin assembly is cocked. When cocked, the firing pin cocking arm will be located in the small cocked notch. See Picture 7.

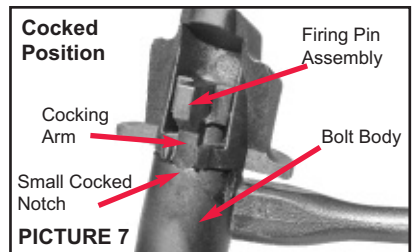

4. If the firing pin assembly is NOT cocked (as shown in Picture 7a), cock the assembly by holding the bolt body steady while turning the firing pin assembly clockwise until the cocking arm is resting in the small cocked notch as in Picture 7.

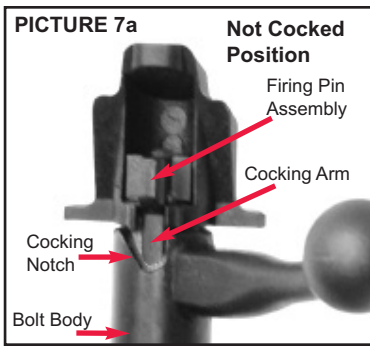

- If your firearm is equipped with an integrated Security System, make sure the system is disengaged and the red indicator dot is visible. See page 9 for engagement and disengagement instructions.
- Before installing the bolt assembly, make sure the bolt head pin is installed. See Picture 7b.

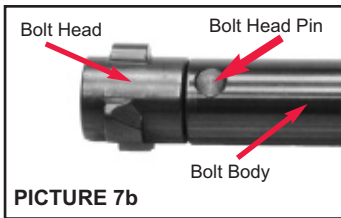

- If the bolt head pin is **NOT** installed, see “To Reassemble the Bolt Assembly”, page 17.

**WARNING!** When the bolt head pin is **NOT** installed in the bolt assembly; the firearm is **NOT** safe to use. Leaving the bolt head pin out of the assembly may cause property damage, personnel injury and/or death to you and/or others.

- Ensure the bolt stop lever, located on the shooter’s left of the receiver, is disengaged by rotating it counter-clockwise to the vertical (up) position. See Picture 8.



- Align the bolt lugs with receiver’s lug cuts then slide the bolt assembly forward.
- Lock the bolt assembly into the receiver by pushing the bolt stop downward, rotating it clockwise until it snaps into the horizontal position. See Picture 9.

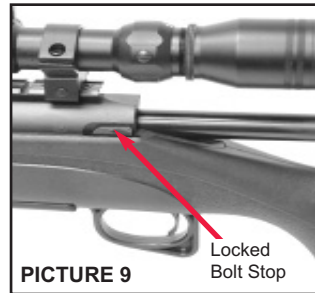

**WARNING!** When the bolt assembly is in the closed position and the *safety mechanism* is in the “**FIRE**” or “**F**” position, the firearm can be discharged by pulling the trigger.

### To Remove the Bolt Assembly:

- Always keep the firearm pointed in a safe direction.
- Engage the safety mechanism by moving the safety arm fully rearward to the “**SAFE**” or “**S**” position.
- Keep fingers and other obstructions away from the trigger.
- Open the action by raising the bolt handle.
- Disengage the bolt stop by rotating the bolt stop lever until the lever is in the vertical position. See Picture 8.
- Slide the bolt assembly rearward until it clears the receiver.
- Look into the ejection port, visually check the chamber and magazine to make sure the firearm is completely unloaded.

### The Trigger Assembly

**Pulling the trigger DISCHARGES the firearm.**

The trigger assembly of your firearm has been set at the Remington factory. The trigger assembly is not adjustable. All repairs to the trigger assembly must be made by the factory or a Remington Authorized Repair Center.



**WARNING!** Never place your finger on the trigger unless you are ready to discharge or fire the firearm.

**WARNING!** Never manipulate, adjust or change any of the internal components of your firearm unless specifically directed to do so in this instruction manual. Improper manipulation of any internal component may affect the safety and reliability of your firearm and may cause serious injury or death.

## The Barrel

**WARNING!** The inside of the barrel must be clean and free of any obstructions. See the “Ten Commandments of Firearm Safety”, on page 2.

### To Check the Barrel for Obstructions:

1. Always keep the firearm pointed in a safe direction.
2. Engage the safety mechanism by moving the safety arm fully rearward to the “SAFE” or “S” position.
3. Remove the magazine from the firearm. See page 13, “How To Unload Firearm”.
4. Open the action by raising the bolt handle.
5. Pull the bolt fully rearward.
6. Look into the ejection port, visually check the chamber and magazine to make sure the firearm is completely unloaded.
7. Remove the bolt assembly from the receiver by rotating the bolt stop lever counterclockwise until the lever is in the vertical position. See Picture 8.
8. Pull the bolt rearward, sliding the bolt assembly from the receiver.
9. To check for an obstruction look through the receiver and barrel from the chamber end.

### To Remove a bore Obstruction:

**WARNING!** NEVER try to remove an object from the barrel by loading another cartridge and firing. This may cause serious personal injury or death.

1. Always keep the firearm pointed in a safe direction.
2. From the chamber end of the barrel, insert a correct size cleaning rod until the obstruction is detected.
3. Lightly tap the cleaning rod against the obstruction to free the object from the barrel.

4. Push the rod completely through the barrel until the rod can be seen at the muzzle.
5. If an object cannot be easily pushed out of the barrel with a cleaning rod, return the firearm to the factory or to a Remington Authorized Repair Center.

**Note:** To clean the barrel follow instructions shown on page 14, “To Clean the Barrel”.

**WARNING!** Before loading the firearm, make sure the inside of the barrel is free of dirt, oil, or other obstructions.

## To Load the Firearm:

**WARNING!** The Model 710™, 715™ and 770™ centerfire bolt action firearms are manufactured in a variety of centerfire calibers. The specific caliber of centerfire ammunition suitable for use in your firearm is marked on the barrel of your firearm. Only use the specific caliber of centerfire ammunition which is designated on the barrel of your firearm. Different calibers of centerfire ammunition are not interchangeable. Do not use any ammunition other than what is designated for your firearm. **Using incorrect ammunition in your firearm can result in a severe malfunction of your firearm and/or ammunition leading to personal injury or death. See the “Ten Commandments of Firearm Safety”, on page 2.**

## Ammunition:

Always check the cartridge for the correct designation before loading the firearm. To find additional ammunition information, see the Remington Arms catalog or visit the Remington website at [www.remington.com](http://www.remington.com).

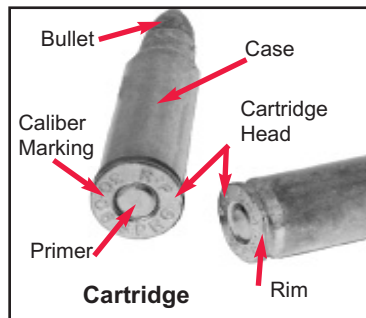

**WARNING!** Do not apply oil, grease or any lubricants to cartridges.

## To Fully Load the Firearm:

**WARNING!** Always check the cartridge for the correct designation before loading the firearm.

**Caution:** The bore should be cleaned before loading the firearm the first time. Follow the cleaning instructions shown on Page 14, "To Clean Barrel".

1. Always keep the firearm pointed in a safe direction.
2. Engage the safety mechanism by moving the safety arm fully rearward to the "SAFE" or "S" position.
3. Open the action by raising the bolt handle, then pulling the bolt fully rearward.
4. Look into the ejection port, visually check the chamber and magazine to make sure the firearm is completely unloaded. If the chamber is not empty, see page 13, "How To Unload the Firearm".
5. Make sure the barrel is free of obstructions, see page 11, "To Check the Barrel for Obstructions".

## I. To Load the Chamber:

6. With an empty magazine installed, place one cartridge of the correct caliber through the ejection port onto the magazine follower. See Picture 10.



7. Slide the bolt assembly fully forward, pushing the cartridge into the chamber.
8. Once the cartridge is chambered, rotate the bolt handle down, locking the cartridge in the chamber.

**WARNING!** The firearm is Now loaded with a cartridge in the chamber. Removing the magazine from the firearm does **NOT** prevent the firearm from being discharged. If a cartridge is in the chamber and the safety mechanism is in the "FIRE" or "F" position, the cartridge in the chamber can be discharged by pulling the trigger.

## II. To Load the Magazine:

**WARNING!** Always check the cartridge for the correct caliber before loading the firearm. Do not attempt to exceed the cartridge capacity of the magazine box.

9. Remove the magazine from the firearm by pressing the magazine latch release then pulling the magazine box from the magazine well. See Picture 11.

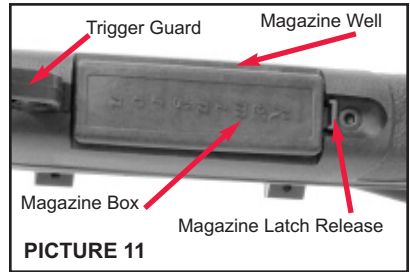

10. Push up to four (4) cartridges of the correct type and caliber, one at a time, sliding the cartridge under the magazine retaining lips until the cartridge head is against the rear wall of the magazine. Keep the cartridge bullet pointing toward the chamber. See Picture 12.

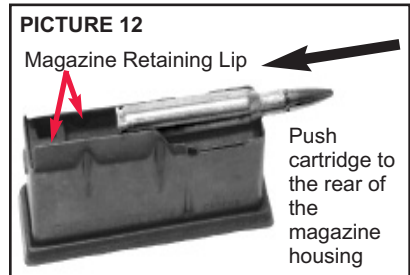

11. Push the full magazine box into the magazine well of the firearm.
12. Make sure the magazine box is fully and securely latched into position.

**Both the chamber and magazine are now fully loaded!**

**WARNING!** The firearm is now cocked and fully loaded. Make sure the safety mechanism is still engaged in the “SAFE” or “S” position. Always keep the firearm pointed in a safe direction.

### To Load the Chamber From the Magazine:

1. Always keep the firearm pointed in a safe direction.
2. Engage the safety mechanism by moving the safety arm fully rearward to the “SAFE” or “S” position.
3. Open the action by raising the bolt handle, then pulling the bolt fully rearward.
4. Look into the ejection port, visually check the chamber and magazine to make sure the firearm is completely unloaded. If the chamber is not unloaded, see page 13, “How To Unload the Firearm”.
5. Make sure the barrel is free of obstructions, see page 11, “To Check the Barrel for Obstructions”.
6. Push a full magazine box (see “To Load the Magazine”, page 12) into the magazine well of the firearm.
7. Make sure the magazine box is fully and securely latched into position.
8. Slowly slide the bolt assembly forward stripping one cartridge from the magazine box.
9. Once the bolt is fully forward, rotate the bolt handle down, locking the cartridge in the chamber.

**WARNING!** The firearm is now cocked and loaded. Make sure the safety mechanism is still engaged in the “SAFE” or “S” position. Always keep the firearm pointed in a safe direction.

### To Discharge the Firearm:

**WARNING!** Always wear eye and hearing protection when discharging your firearm. See “The Ten Commandments of Firearm Safety”, on page 2.

1. Point the muzzle at your intended target.
2. Disengage the safety mechanism by moving the safety lever to the “FIRE” or “F” position.
3. With the butt of the firearm firmly mounted against your shoulder and target acquired, pull the trigger. The firearm will discharge each time the trigger is pulled and the action is cycled



until the magazine and chamber are empty.

4. Engage the safety mechanism by moving the safety lever rearward to the “SAFE” or “S” position.
5. Open the action by raising the bolt handle, then pulling the bolt fully rearward.
6. Look into the ejection port, visually check the chamber and magazine making sure the firearm is completely unloaded.

### How To Unload the Firearm

**WARNING! NEVER** assume your firearm is unloaded to justify careless handling. Always control the direction of the muzzle of your firearm, even if you think it is completely unloaded.

1. Always keep the firearm pointed in a safe direction.
2. Engage the safety mechanism by moving the safety arm fully rearward to the “SAFE” or “S” position.
3. Remove the magazine box from the firearm by pressing the magazine latch release lever then pulling the magazine box from the magazine well. See Picture 11.

**WARNING!** This firearm does NOT incorporate a magazine disconnect. The firearm can discharge with the magazine removed!

4. Open the bolt by raising the bolt handle, then pull the bolt fully rearward until the cartridge clears the chamber.
5. Lift the cartridge outward and remove from the receiver through the ejection port.
6. With the bolt open, visually check the chamber to make sure the firearm is completely unloaded and free of obstructions.

### To Unload the Magazine:

7. While holding the magazine separate and apart from the firearm, slide the top cartridge forward and out of the magazine. Repeat until the magazine is completely empty.

**WARNING!** Cartridges in magazine are under spring compression. Wear eye protection to avoid possible serious personal injury.



## Telescopic Sights

A telescopic sight mount has been installed on your Model 710™, 715™, 770™ receiver. All models with telescopic sights are adjusted at the factory to hit a target at 100 yards. If your telescopic sight requires adjustment, see the telescopic instruction sheet provided in the packaging.

**WARNING!** Before mounting or adjusting any telescopic sight, make sure the firearm is completely unloaded and the safety mechanism is engaged by placing the safety in the “SAFE” or “S” position.

**NOTE:** For ballistics and trajectory information, see the Remington catalog or visit the Remington website at [www.remington.com](http://www.remington.com).

## Cleaning, Lubrication and Maintenance

**WARNING!** Before cleaning, make sure your firearm is completely unloaded (both the chamber and the magazine) and engage the safety mechanism by placing the safety lever in the “S” or “SAFE” position.

**WARNING!** After each use, follow the lubrication and maintenance directions in this Owner's Manual. If the firearm is immersed in water, it must be thoroughly cleaned and lubricated as soon as possible. In case of saltwater immersion, first flush all parts with fresh water, then dry, clean and lubricate the firearm. If the firearm does not function properly, have it checked and corrected by a Remington Authorized Repair Center before further use. Failure to follow these instructions may lead to firearm malfunctions which could result in serious personal injuries or death.

**Caution:** The chamber and bore should be cleaned before loading and firing the firearm the first time.

## Lubrication:

**Over-lubrication** should be avoided at all times. A light application of Rem™ Oil helps to prevent rusting.

**WARNING!** Excessive use of a lubricant could adversely affect the function and safe operation of your firearm. Failure to properly maintain your firearm can not only damage your firearm, it can expose you and others to unnecessary risks of personal injury or death.

When the firearm is to be stored, it should be carefully cleaned and thoroughly oiled. Outside metal surfaces should be wiped with Rem™ Oil occasionally. When the firearm is to be reused, all excess lubrication must be removed. The chamber and bore must be thoroughly wiped dry.

For safe and dependable operation of your firearm, the barrel and action must be cleaned periodically.

**NOTE:** Remington's Rem™ Oil is available from your local dealer. If your dealer is out of stock, ask him to order Rem™ Oil from his Remington Distributor.



## To Clean the Barrel:

**WARNING!** Unload the firearm before cleaning. Look into the ejection port and visually check the chamber and magazine to make sure there are no cartridges in the firearm. Always wear eye protection when handling, disassembling and reassembling the firearm.



1. Always keep the firearm pointed in a safe direction.
2. Engage the safety mechanism by moving the safety arm fully rearward to the “SAFE” or “S” position.
3. Remove the magazine box from the firearm by pressing the magazine latch release lever then pulling the magazine box from the magazine well. See Picture 11.

4. Open the action by raising the bolt handle.
5. Disengage the bolt stop by rotating the bolt stop lever until the lever is in the vertical position. See Picture 8.
6. Pull the bolt rearward, sliding the bolt assembly from the firearm.
7. Look into the ejection port, visually check the chamber and magazine to make sure the firearm is completely unloaded.
8. Use the instructions and equipment provided in a quality cleaning kit such as a Remington Cleaning Kit. For recommendations, see your dealer or a Remington Authorized Service Center.
9. Saturate cleaning patch with Brite Bore™ or equivalent.
10. Attach the patch to a cleaning rod tip.
11. Pass the patch through bore from the chamber end to the muzzle several times removing loose residue and fouling.
12. Select the correct caliber cleaning brush and attach a brush to the cleaning rod.
13. Spray bore brush with Brite Bore.
14. Push the cleaning rod through the barrel several times.
15. Remove the brush from the rod and attach a tip with a cleaning patch.
16. Push the cleaning patch through the bore.
17. Repeat several times using a new cleaning patch each time until the patch is removed from the barrel without fouling residue.
18. Push a clean patch saturated with Rem™ Oil through the barrel.
19. Push a clean dry patch through the barrel to remove excess lubricant.
20. Apply a light application of Rem™ Oil to the outside of the barrel with a soft clean cloth.

**WARNING!** After cleaning, Make sure the barrel is free of obstructions. See page 11, "To Check the Barrel for Obstructions."

## To Disassemble and Clean the Firearm:

**CAUTION:** The Model 710™, 715™, 770™ firearms should **NOT** be disassembled beyond what is described in this manual, except by the factory or a Remington Authorized Repair Center.

**WARNING!** Unload the firearm before cleaning. Look into the ejection port and visually check the chamber and magazine to make sure there are no cartridges in the firearm. Always wear eye protection when handling, disassembling and reassembling the firearm.



1. Always keep the firearm pointed in a safe direction.
2. Engage the safety mechanism by moving the safety arm fully rearward to the "SAFE" or "S" position.
3. Remove the magazine box from the firearm by pressing the magazine latch release lever then pulling the magazine box from the magazine well. See Picture 11.
4. Open the action by raising the bolt handle.
5. Disengage the bolt stop by rotating the bolt stop lever until the lever is in the vertical position. See Picture 8.
6. Pull the bolt rearward, sliding the bolt assembly from the firearm.
7. Look into the ejection port, visually check the chamber and magazine to make sure the firearm is completely unloaded.
8. Remove the barreled/action from the stock by removing the three takedown screws, using a 1/8" and 1/16" Allen Wrench. See Picture 13.

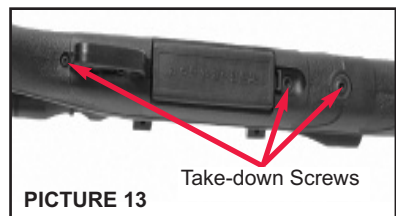

9. Lift the barreled/action from the stock.

## To Clean the Receiver:

10. Thoroughly spray then brush all components inside the receiver using Rem™ Action Cleaner.
11. Air dry or use compressed air to thoroughly dry the receiver assembly.
12. Apply a light application of Rem™ Oil to the inside and outside of the receiver.

## To Clean and Lubricate the Trigger Assembly:

**NOTE:** Clean and lubricate the receiver and trigger assemblies as a unit.

Do not remove the trigger assembly from the receiver.

13. Thoroughly spray inside the trigger assembly at the four points specified in Picture 14 with Rem™ Action Cleaner.

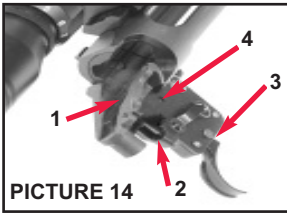

14. Disengage the safety by moving the safety mechanism to the "F" or "FIRE" position. Pull the trigger rearward and release multiple times.
15. Pull and hold the trigger rearward. While using a small punch or screwdriver, depress the sear (Lubrication Point 1, see Picture 14) and release multiple times. See Picture 15.

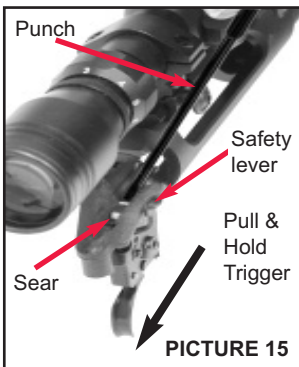

16. Release the trigger and operate the safety lever from the "FIRE" to the "SAFE" position multiple times.

17. Again thoroughly spray inside the trigger assembly at the four points specified in Picture 14 with Rem™ Action Cleaner. Air dry or use compressed air to thoroughly dry the trigger assembly.
18. Place one drop of Rem™ Oil in each of the four (4) points in the trigger assembly specified in Picture 14.
19. Disengage the safety by placing the safety arm in the "F" or "FIRE" position. Pull the trigger rearward and release multiple times. Ensure the trigger returns completely to the forward position each time.

**WARNING!** If the trigger does not fully return to the forward position each time it is released, then your firearm is **NOT** in a safe operating condition and it must **NOT** be used until you have had it repaired by a Remington Authorized Repair Center.

20. If the trigger completely returns as specified in step 19, pull and hold the trigger rearward while using a small punch or screwdriver to depress and release the sear multiple times. See Picture 15.

**WARNING!** If the sear does not return to the full upward position without hesitation, then your firearm is **NOT** in a safe operating condition and it must **NOT** be used until you have had it inspected and repaired by a Remington Authorized Repair Center.

21. If the sear freely returns to the full upward position as specified in step 20, release the trigger and operate the safety mechanism from the "FIRE" to the "SAFE" position multiple times. The safety mechanism must operate freely. The safety arm or lever must be positioned fully in the "S" or "SAFE" position. The safety should **NOT** remain in a position anywhere between the "SAFE" and "FIRE" position. If the safety mechanism does not freely return to the full "SAFE" or "FIRE" position, repeat steps 13 thru 21. **If the safety mechanism does not freely return to the "SAFE" or "FIRE" position after repeating operations 13 thru 21, return the firearm to a Remington Authorized Repair Center for an inspection of the safety and trigger assembly.**

- Place the safety in the "S" or "SAFE" position and lightly spray Rem™ Oil on all the external surfaces of the trigger assembly and receiver. Wipe off excess oil.

## To Disassemble the Bolt Assembly:

- With the bolt assembly removed from the firearm (see "To Remove the Bolt Assembly", page 10), compress the firing pin spring by placing pliers on the firing pin head and bolt plug as shown in Picture 16.

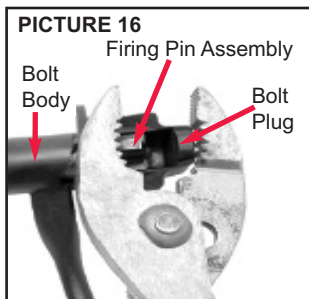

- Rotate the bolt plug and firing pin assembly clockwise 1/8th of a turn. See Picture 17.

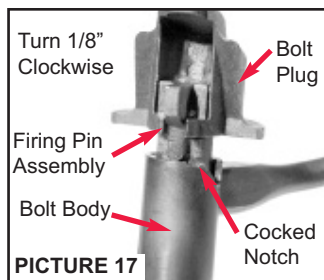

- Remove the firing pin assembly from the bolt body by pulling the bolt plug outward.
- Remove the bolt head from the bolt body by removing the bolt head pin with a punch. See Picture 18.

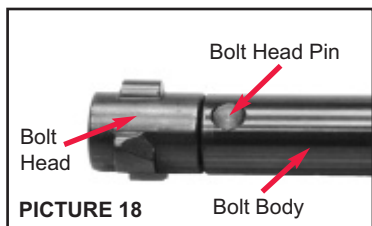

## To Clean the Bolt and Firing Pin Assemblies:

**Caution!** Clean the firing pin assembly as a unit. Do not disassemble.

- Thoroughly spray and brush all bolt assembly components including the firing pin assembly using Rem™ Action Cleaner.
- Air dry or use compressed air to thoroughly dry all components in the bolt assembly.
- Apply a light application of Rem™ Oil to all surfaces of the bolt assembly.
- If desired, apply grease to the cocking notch.

## To Reassemble Bolt Assembly:

- Push the bolt head into the bolt body. Align the bolt head pin and bolt body holes as shown in Picture 19. Orient the bolt handle 180 degrees from the ejector, as viewed from the front.

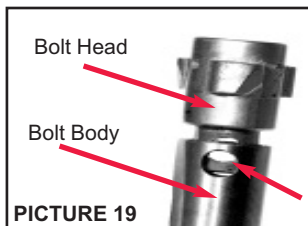

**WARNING!** When the bolt head pin is **NOT** in the bolt assembly, the firearm is **NOT** safe to use. Leaving the bolt head pin out of the assemble can cause serious personnel injury or death to you and others.

- Insert the bolt head pin through the bolt body and bolt head. If assembled correctly, the bolt handle will be 180 degrees from the ejector, as viewed from the front. See Picture 20.

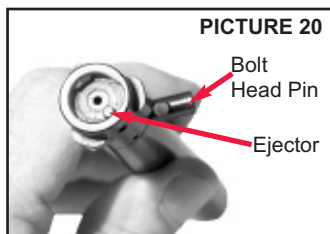

- Insert the firing pin assembly in the bolt body, with the firing pin head approximately 1/8 of a turn clockwise from the small cocked notch. See Picture 21.

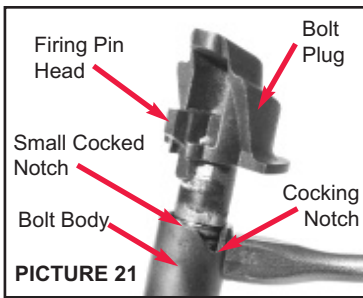

4. Compress the bolt plug, then rotate 1/8 turn counter-clockwise until the cocking arm is located in the small cocked notch. See Picture 22.

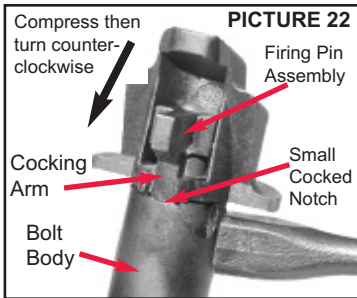

**NOTE:** While your bolt action firearm has been designed and manufactured to provide improved corrosion protection, only proper care will keep your firearm in good operating condition and maintain its appearance. After extensive use, the protective coating on plated parts may be worn sufficiently reducing the corrosion protection. Such worn parts should be replaced to assure the integrity of the corrosion protection.

## To Disassemble Magazine:

**NOTE:** For instruction how to remove the magazine from the firearm, see “To Load the Magazine”, page 12.

**WARNING!** Use extreme care when removing the magazine bottom, as the magazine spring is under compression. Wear eye protection to avoid serious personal injury.

1. Remove the magazine bottom from housing by placing a small flat screw driver blade between the magazine housing locking tab and magazine bottom. Gently pry the two components apart. See Picture 23.

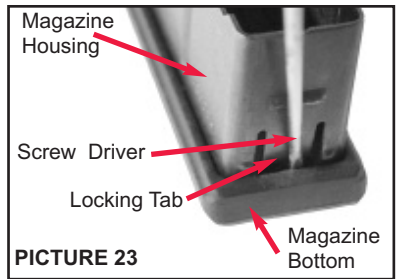

2. Remove the magazine bottom, spring, and follower from magazine housing.

## To Clean the Magazine:

1. Thoroughly spray and brush all magazine assembly components using Rem™ Action Cleaner.
2. Air dry or use compressed air to thoroughly dry the magazine assembly components.
3. Apply a light application of Rem™ Oil to all metal surfaces.

## To Reassemble the Magazine:

1. Insert the follower into the magazine housing from the bottom. Orient the follower's cartridge bias in the rear of the housing.
2. For Short Action magazine housings, insert the “short action” spacer in the rear of the magazine housing.
3. Place the short leg of the magazine spring into the magazine housing. The last bend in the spring should be oriented toward the rear of the magazine box. See Picture 24.

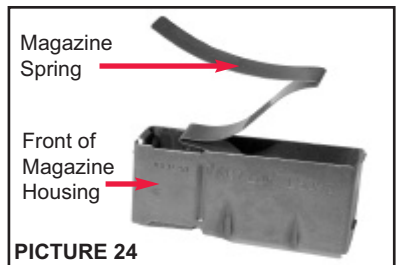

4. Place the magazine bottom on to the magazine spring with the Remington “R” at the front of the magazine box. See Picture 25.



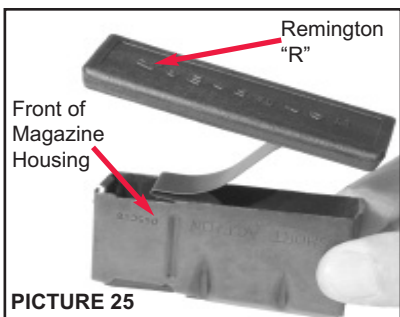

PICTURE 25

5. Compress the spring with the magazine bottom on to the magazine housing until the bottom snaps into place.
6. Ensure the follower moves freely.
7. Reassemble if follower does not move freely without hesitation.

## To Reassemble the Barreled Action to Stock:

1. With the bolt assembly and magazine removed, place the barrel/action into the stock.
2. Replace and tighten (clockwise) the takedown screws to the following torque specifications:  
Front Screw: 55 to 60 inch pounds  
Middle Screw: 40 to 45 inch pounds  
Rear Screw: 15 to 20 inch pounds.  
See Picture 13 on page 15.

**WARNING!** Before replacing the bolt assembly, make sure the barrel is free from obstructions. See "To Check for Barrel Obstructions", on page 11.

3. Install the bolt assembly. See instruction on page 9, "To Install the Bolt Assembly".
4. Push the magazine box into the receiver's magazine well until the latch fully engages.
5. Ensure the safety is engage by placing the safety mechanism in the "Safe" or "S" position.

## To Function Test the Firearm:

When the firearm is fully reassembled, a short function test should be conducted to ensure proper operation before loading or discharging the firearm. If the firearm does not function as described in any part of the Function Test procedure, then the firearm should be reassembled and function tested again. Do **NOT** discharge the firearm. If the firearm fails the Function Test again, DO **NOT** discharge the

firearm. The firearm should be sent to a Remington Authorized Repair Center or call: 1-800-243-9700, Mon - Fri., 9:00AM-5:00PM Eastern Time.

**WARNING!** Completely unload the firearm before Function Testing. Look into the ejection port and visually check the chamber and magazine to make sure there are no cartridges in the firearm. Always wear eye protection when handling the firearm.

1. Always keep the firearm pointed in a safe direction throughout the Function Testing process.
2. Engage the safety mechanism by moving the safety arm fully rearward to the "SAFE" or "S" position.
3. Open the action by raising the bolt handle, then pulling the bolt fully rearward. The bolt should stop on the bolt stop at the rear of the stroke.
4. Look into the ejection port, visually check the chamber and magazine to make sure the firearm is completely unloaded. Also make sure the barrel is free of obstructions.
5. Verify the bolt head pin is present. See Picture 26.

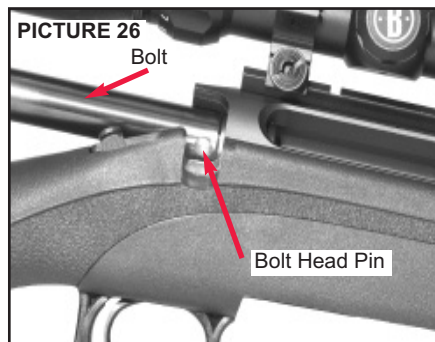

**WARNING!** If bolt head pin is missing; do **NOT** use the firearm. The firearm is **NOT** safe. Using the firearm without a bolt head pin may lead to firearm malfunctions which could result in serious personal injuries or death.

6. Remove the magazine by disengaging the magazine latch while pulling the magazine from the firearm. See Picture 11.
7. Slide the bolt forward, then push the bolt handle down, locking the bolt into the firing position.

8. With the safety engaged, pull the trigger rearward and release. The firing pin should not release.
9. Disengage the safety mechanism by moving the safety arm fully forward to the “F” or “FIRE” position.
10. Pull the trigger rearward and release. The firing pin should release.
11. Ensure the trigger returns completely to the forward position each time the trigger is pulled.
12. Cycle the bolt and repeat steps 10 and 11 multiple times.

**WARNING!** If the trigger does not fully return to the forward position each time it is released, then your firearm is **NOT** in a safe operating condition and it must **NOT** be used until you have it inspected and the problem corrected by a Remington Authorized Repair Center.

13. If the trigger completely returns as specified in step 11, remove the bolt. See page 10, “To Remove the Bolt Assembly”.
14. With the safety disengaged, pull and hold the trigger rearward while using a small punch or screwdriver to depress the sear then releasing multiple times. The sear must return to the full upward position without hesitation. See Picture 27.

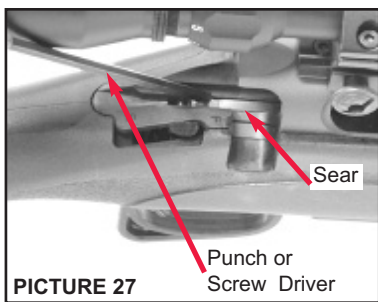

**WARNING!** If the sear does not return to the full upward position without hesitation, then your firearm is **NOT** in a safe operating condition and must **NOT** be used until you have it inspected and the problem corrected by a Remington Authorized Repair Center.

15. If the sear freely returns to the full upward position as specified in operation 14, release the trigger and operate the safety from the Fire “F” to

the Safe “S” position multiple times. The safety must operate freely. The safety arm must be positioned in the full Safe “S” or full Fire “F” position.

16. Repeat steps 14 and 15 multiple time.

**WARNING!** If the safety does **NOT** freely return to the full Safe “S” or full Fire “F” position after repeating steps 14 thru 15 multiple times, then your firearm is **NOT** in a safe operating condition and it must **NOT** be used until you have had it inspected and corrected by a Remington Authorized Repair Center.

17. Engage the safety mechanism by moving the safety arm fully rearward to the “SAFE” or “S” position.
18. Install the bolt assembly into the receiver. See page 9, “To Install the Bolt Assembly”.
19. Pull the trigger fully rearward. The firing pin must **NOT** release.
20. Place the empty magazine into the magazine well until it is latched fully.
21. Disengage the safety by placing the safety mechanism in the “FIRE” or “F” position.
22. Close the action smartly (with force) by moving the bolt assembly fully forward quickly. Once fully forward, push down on the bolt handle, coming the bolt into the locked position.
23. The firing pin must **Not** release and the empty magazine should remain latched in position.
24. To check if firing pin released, (with the safety mechanism disengaged), pull the trigger fully rearward. The firing pin should release.
25. Repeat steps 21 thru 24 multiple times.

**WARNING!** If the firing pin does **NOT** remain cocked when the bolt is closed smartly, the firearm is **NOT** safe to use. Return the firearm to the factory or to a Remington Authorized Repair Center.

26. Engage the safety mechanism by moving the safety arm fully rearward to the “SAFE” or “S” position.



# MODEL 710™, 715™, 770™

## Bolt Action Centerfire Rifle

### Exploded View

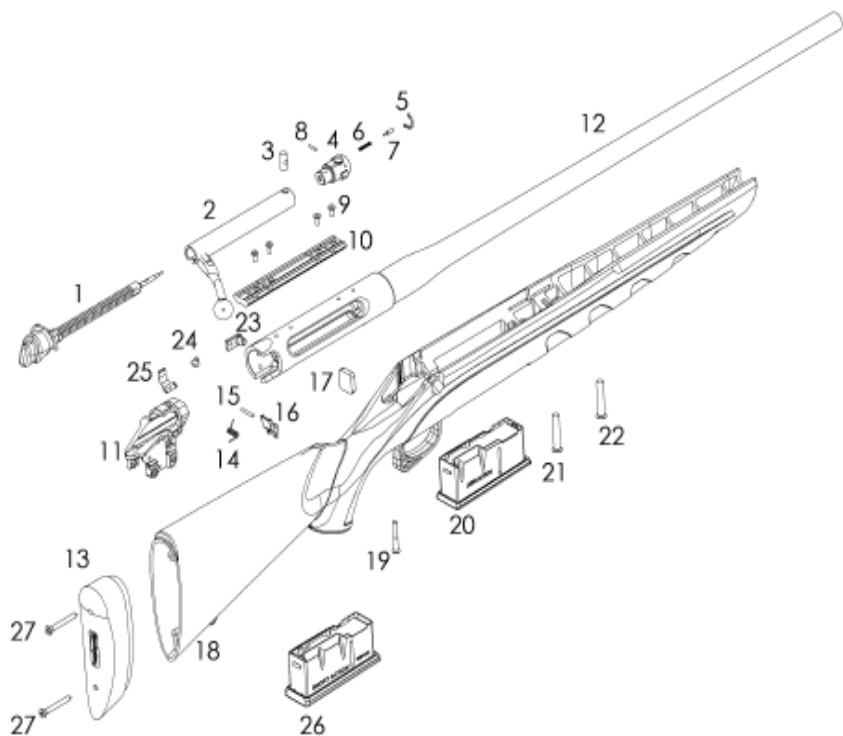

Schematic is provided for part identification only and should not be used as a guide to assemble the firearm.

# MODEL 710™, 715™, 770™

## Bolt Action Centerfire Rifle

### PARTS LIST

Note: Parts are subject to change without notice.

ITEM NO.	PART NAME	ITEM NO.	PART NAME
1	Firing Pin Assembly	14	Latch Spring
2	Bolt Body Assembly	15	Latch Pivot Pin
3	Bolt Assembly Pin	16	Magazine Latch
4	Bolt Head	17	Recoil Bracket
5	Extractor	18	Stock
6	Ejector Spring		Stock Assembly Complete
7	Ejector	19	Rear Take-Down Screw
8	Ejector Pin	20	Magazine Assembly; LA
	Bolt Assembly Complete	21	Middle Take-Down Screw
9	Scope Rail Screw (4)	22	Front Take-Down Screw
10	Scope Rail	23	Bolt Stop
	Scope (Not Shown)	24	Support Screw
11	Receiver Insert Assembly	25	Bolt Stop Spring
12	Barrel Assembly	26	Magazine Assembly; SA
13	Recoil Pad	27	Recoil Pad Screw (2)



# How to Obtain Parts and Service From Remington® Arms Co.

## To Order Parts:

To order parts please visit [www.remingtonpartsstore.com](http://www.remingtonpartsstore.com) or call 1-800-243-9700. For additional information on service enhancements, upgrades, repair, additional barrels, and specialty parts visit [www.remington.com](http://www.remington.com).

To place an order or for additional information on service enhancements, up grades, and additional barrels, please call us toll free consumer service number, 1-800-243-9700, Mon.-Fri., 9:00 AM-5:00 PM Eastern time.

1. Fax completed order form (from the web site) to 1-336-548-7801.
2. To order by phone without the order form call 1-800-243-9700.

## Please have the following information ready before you call.

- Firearm model and serial number.
- Part description and quantity. Part descriptions can be found on the parts listing page 23 in this manual.
- Your complete mailing address (P.O. Box and Street Address) including zip code, telephone number and e-mail address.
- Method of payment: MasterCard, Visa, Amex or Discover card number and expiration date. A quote may be made to you over the phone. (Sorry, no C.O.D.s.)

**WARNING!** Use only Remington parts in Remington's firearms.

**NOTE:** Some parts may be restricted. See parts list for details. Owner's manuals/instruction books may be requested via our web site at: [www.remington.com](http://www.remington.com) or by calling 1-800-243-9700.

## Repair Services

If there is a defect with your Remington firearm that (i) you believe is, or should be, covered by the Warranty, (ii) you would like Remington to address at your cost and expense, or (iii) you would otherwise like to discuss with Remington, please contact Remington Consumer Services at 1-800-243-9700, Mon.-Fri 9:00AM – 5:00PM. Please do not send your firearm or other item to Remington without first (a) calling this number, (b) receiving instructions from the Remington representative, and (c) obtaining a Service Request document containing your Service Repair Number. With regards to the Service Request document, Remington will either e-mail this document to you or, if you do not have an e-mail address Remington will mail it to you. Please be sure to store your Service Request document in your records so that it is both safe and accessible. Finally, to the extent you seek Warranty coverage, please review the Warranty for your Remington firearm and note that you may void your Warranty by taking action without first contacting Remington.

If shipment of your firearm is required, a SRN must be obtained prior to shipment and please follow the following instructions:

- Record the serial number of your firearm before shipping.
- Pack your firearm for safety and to prevent further damage in shipping and handling
- Remove all accessories from the firearm to prevent loss or damage.
- Place your approved Service Repair Number (SRN) on the shipping label.
- Check your government guidelines before shipping.
- Remington is not responsible for damage or loss during shipment. You may elect to purchase insurance from your carrier.

**WARNING!** Do not send live or spent shells in your firearm or in the same box with the firearm. This is a violation of federal law. If you feel you must send spent shells, please send them in a separate package and include name, address (with zip code), telephone number, model and serial number of your firearm.

# Firearm Owner's Record

Model: \_\_\_\_\_

Serial # \_\_\_\_\_

Date Purchased: \_\_\_\_\_

Purchased From: \_\_\_\_\_

Price Paid: \_\_\_\_\_

Remember to complete and return the Firearm Warranty Registration Card in order to obtain full benefit of your Limited Two Year Firearm Warranty.

## **A WORD ON THE MAINTENANCE AND CARE OF YOUR REMINGTON FIREARM**

### **Don't Alter or Modify Your Firearm and Have it Serviced Regularly.**

*Your firearm* has been designed to operate according to certain factory specifications. You'll jeopardize your safety and that of others around you by attempting to alter its trigger, mechanical safety or other mechanisms. Never alter or modify your firearm in any way.

*Like any mechanical device*, a firearm is subject to wear. It must be maintained and periodically serviced to assure optimum safety and performance. Only a qualified service facility should service, repair or modify your Remington firearm. Consult your instruction manual for location of the nearest Authorized Remington Repair Center.

Remington recommends that you have your firearm professionally serviced annually. You should also have your firearm professionally serviced after prolonged storage, or if there is ever any question pertaining to the proper functioning characteristics of your firearm.

*Proper cleaning and lubrication* are also important to firearm maintenance and are necessary to assure accuracy, safety, and reliability. Before cleaning, always make sure that your firearm is completely unloaded. And always clean the barrel from the chamber end to the muzzle when possible.

### **Firearm Sale or Transfer:**

If your firearm has been adjusted or changed in any way and you intend to sell or otherwise transfer possession of your firearm, you must: 1) provide a complete service record, (2) warn the purchaser or recipient of your firearm that it has been adjusted or modified, and (3) give the purchaser or recipient this owner's manual for review and reference. If you do not wish to sell or transfer your firearm in an adjusted condition (recommended), return it to a Remington Authorized Repair Center for restoration of your firearm to the original factory conditions. Do Not attempt to restore the firearm to factory conditions yourself.

**WARNING!** NEVER alter or modify any part of the firearm. Improper alterations can make the firearm unsafe and result in personal injury or death to you or others.

This firearm should not be sold where prohibited by federal, state or local laws.



**MODEL 710™, 715™, and 770™  
Bolt Action Centerfire Rifles**

*Remington*®

REMINGTON IS A TRADEMARK REGISTERED IN THE UNITED STATES PATENT  
AND TRADEMARK OFFICE BY REMINGTON ARMS COMPANY, LLC

PRINTED IN THE U.S.A.

302391 7.15 REV.