

**1873
SINGLE ACTION
REVOLVERS**



F.LLI PIETTA

HISTORICAL WEAPONS
REPRODUCTION



Made in Italy by



F.LLI PIETTA

F.A.P. Fabbrica Armi F.lli PIETTA
di Pietta Giuseppe & C. srl

Via Mandolossa, 102
25064 GUSSAGO (BS) Italy
Cod. Fisc. P.Iva IT0027440025
Fax 39 030 37 37 100

www.pietta.it

e-mail: customerservice@pietta.it

**Manuale di istruzioni
e di sicurezza
per i Revolvers
1873 Single Action**

*Instruction and
Safety Manual for
1873 Single Action
Revolvers*



**LEGGERE ATTENTAMENTE LE ISTRUZIONI E LE AVVERTENZE CONTENUTE IN QUESTO MANUALE PRIMA DI MANEGGIARE, CARICARE O SPARARE CON QUEST'ARMA!!
READ THE INSTRUCTIONS AND WARNINGS IN THIS MANUAL CAREFULLY AND THOROUGHLY BEFORE HANDLING, LOADING OR SHOOTING THIS FIREARM!!**

1873 SINGLE ACTION REVOLVERS

ENGLISH

INDEX

THIS MANUAL CONTAINS	26
SAFETY PRECAUTIONS & WARNING	28
HANDLING WITH SAFETY MANUAL	32
INSTRUCTIONS FOR THE USE OF THE MANUAL SAFETY	33
COCKING WITH SAFETY TRANSFER BAR	35
INSTRUCTIONS FOR THE USE OF THE TRANSFER BAR SAFETY	36
DECOCKING (UNCOCKING) THE REVOLVER	39
LOADING AND FIRING	41
UNLOADING	43
CARE AND CLEANING	44
STORAGE	46
LEAD EXPOSURE	47
STATE WARNINGS	48
1873 SINGLE ACTION REVOLVERS NOMENCLATURE	51

THIS MANUAL CONTAINS

- ▶ Important warnings which should be read and understood before using this firearm.
- ▶ Directions and procedures for handling, loading, firing and unloading.
- ▶ Instructions for care and cleaning.
- ▶ **This instruction and safety manual is designed to help you in learning how to properly use and care for your F.lli Pietta 1873 Single Action Revolver. Only when you are certain you have fully familiarized yourself with the function of your firearm should you practice loading, unloading and firing with live rounds of ammunition.**

This instruction manual should always accompany this firearm, and be transferred with it upon change of ownership.

WARNING: DISCLAIMER OF LIABILITY

F.LLI PIETTA SRL SHALL NOT BE RESPONSIBLE FOR PRODUCT MALFUNCTIONING OR FOR PHYSICAL INJURY, DEATH OR DAMAGE TO PROPERTY RESULTING FROM EITHER INTENTIONAL OR ACCIDENTAL DISCHARGE OF THIS FIREARM, ITS CRIMINAL OR NEGLIGENT USE, IMPROPER OR CARELESS HANDLING, UNAUTHORIZED MODIFICATIONS OR ALTERATION, USE OF DEFECTIVE OR IMPROPER OR HAND-LOADED OR RELOADED AMMUNITION, OR FROM ITS USE FOR PURPOSES OR SUBJECTION TO TREATMENT FOR WHICH IT WAS NOT DESIGNED. **F.LLI PIETTA SRL** WILL NOT HONOR CLAIMS MADE BY THE SECOND OR SUBSEQUENT OWNER OF THE FIREARM.



CAUTION:

PRIOR TO REMOVING THIS GUN FROM ITS PACKAGING, AND PRIOR TO LOADING AND FIRING, CAREFULLY AND THOROUGHLY READ THE ENTIRE INSTRUCTION MANUAL WHICH GIVES ADVICE ON THE GUN'S PROPER HANDLING AND FUNCTIONING. HOWEVER YOUR SAFETY AND THAT OF OTHERS (INCLUDING YOUR FAMILY) DEPENDS ON YOUR RESPONSIBLE COMPLIANCE WITH THAT ADVICE. IF UNFAMILIAR WITH FIREARMS, SEEK SUPERVISED INSTRUCTIONS. FIREARM SAFETY IS YOUR RESPONSIBILITY.



WARNING: A FULLY LOADED UNCOCKED GUN, CAN FIRE!

WHEN THE HAMMER IS UNCOCKED, IT IS RESTING DIRECTLY ON THE CARTRIDGE WHEN FULLY LOADED. A BLOW TO THE HAMMER RESULTING FROM A FALL/DROPPING OF THE GUN CAN CAUSE THE GUN TO DISCHARGE. TO PREVENT ACCIDENTAL DISCHARGES CAUSED BY A BLOW TO THE HAMMER: **ALWAYS** CARRY ALL REVOLVERS WITH THE HAMMER DOWN ON AN EMPTY CHAMBER.



IMPORTANT

TO ENSURE THE SHOOTER A BETTER PROTECTION, ALL FIREARMS MARKED F.LLI PIETTA ARE SUBMITTED TO SEVERE FIRE TESTS EVIDENCED BY RELEVANT MARKINGS, MADE BY THE ITALIAN NATIONAL PROOF HOUSE OF GARDONE V.T. - BRESCIA - ITALY.



WARNING - LEAD EXPOSURE

DISCHARGING FIREARMS IN POORLY VENTILATED AREAS, CLEANING FIREARMS, OR HANDLING AMMUNITION MAY RESULT IN EXPOSURE TO LEAD AND OTHER SUBSTANCES KNOWN TO THE STATE OF CALIFORNIA TO CAUSE BIRTH DEFECTS, REPRODUCTIVE HARM, AND OTHER SERIOUS PHYSICAL INJURY. HAVE ADEQUATE VENTILATION AT ALL TIMES. WASH HANDS THOROUGHLY AFTER EXPOSURE.

SHOOTING OR CLEANING GUNS MAY EXPOSE YOU TO LEAD.

SAFETY PRECAUTIONS & WARNING

1 CARELESS AND IMPROPER HANDLING OF THIS GUN COULD RESULT IN UNINTENDED DISCHARGE CAUSING INJURY, DEATH OR PROPERTY DAMAGE.

Safety must be the first and constant consideration when handling a firearm and ammunition. F.lli Pietta srl shall not be responsible for product malfunctioning or for physical injury, death or damage to property resulting from either intentional or accidental discharge of this firearm, its criminal or negligent use, improper or careless handling, or from its use for purposes or subsection to treatment for which it was not designed.

2 NEVER alter any part or add or replace parts not supplied by F.lli Pietta s.r.l. This product was designed to function properly in its original condition. F.lli Pietta srl shall not be responsible for product malfunctioning or for physical injury, death or damage to property resulting from unauthorized modifications or alterations.

3 ALWAYS carry revolvers with the hammer down on an empty chamber to prevent accidental discharges caused by a blow to the hammer or with the hammer set on the proper safety position.

4 Death, serious injury and damage can result from the use of wrong ammunitions. For your safety use ONLY factory original high quality ammunitions in good conditions which are appropriate to the caliber of your gun.

F.lli Pietta s.r.l. shall not be responsible for product malfunctioning, damages, death, injury resulting from the use of defective or improper or hand loaded or reloaded ammunition.

5 ALWAYS handle and treat your gun as if it were loaded so you never fire it accidentally when you think it is unloaded. NEVER think it is unloaded. NEVER take anyone's word it is unloaded. ALWAYS check it yourself with your fingers off the trigger and the gun pointed in a safe direction at all times, including while loading. NEVER lean over the muzzle.

6 NEVER keep or carry any revolver with the hammer cocked. Cocking the gun or pulling the trigger should only be done when you are ready to shoot immediately.

This way, your gun cannot be unintentionally fired.

7 ALWAYS leave your fingers out of the trigger until you start firing. Note: safety devices on guns are extras and do not substitute for safe handling.

8 NEVER perch the gun on the half-cock notch as it may fall and discharge, causing damage to property, injury or death. The half cock position provides only partial security from accidental discharges. If damaged or modified it provides NO Safety. NEVER depend on this device to prevent accidental discharge!

9 ALWAYS keep the muzzle pointed in a safe direction. This way, if it fires accidentally, personal injury, death or damage to property can be prevented. This is especially important when loading and unloading your gun. NEVER let the muzzle of the firearm point at any part of your body or at another person or at anything you do not intend to shoot, even if you think it is unloaded. ALWAYS be certain of your target before firing.

10 ALWAYS unload all firearms when not in use. NEVER store or transport a loaded firearm. Firearms and ammunition should be safely stored separately in locked receptacles minimizing the risk that the gun and ammunition could be easily available for loading and firing.

11 ALWAYS store your firearms out of sight and reach of children or visitors.

12 ALWAYS make sure your gun is not loaded before cleaning, storing or travelling or before laying it down, or handing it to another person for use.

13 NEVER climb a tree, fence or wall while carrying a loaded firearm. NEVER leave a loaded gun unattended or resting against a tree, fence or wall. Someone, especially a child, may fire it and cause injury, death or damage to property.

14 NEVER shoot at a hard surface or at water. A bullet may ricochet and travel in unpredictable directions to strike you or an object you cannot see, causing injury, death or damage to property.

15 NEVER fire your gun near an animal as the animal's startled reaction could result in injury or accidents.

16 Firearms and alcohol don't mix. NEVER drink alcoholic beverage or take drugs before or during shooting sessions, as this constitutes criminal disregard for your safety and that of others. NEVER use a gun while you are taking medication unless you have checked with your doctor to ensure your fitness to handle your gun safely.

17 Be particularly careful when unloading the revolver to check the cylinder to be certain a live round does not remain in it.

18 Keep all persons nearby to the rear of the shooter. Standing beside or in front of the shooter is not safe. Flames, hot gases and fragments might fly from the side of the gun causing serious injury.

19 If you have any doubts about your ability to handle or use this gun safely DO NOT handle or use this gun. You must seek supervised instruction before doing so.

20 Horseplay has no place around firearms. Guns can't think, you can.

21 REMEMBER, SAFETY IS YOUR RESPONSIBILITY. BE A SAFE SHOOTER AND USE COMMON SENSE AT ALL TIMES.



WARNING:

DEATH, SERIOUS INJURY, AND PROPERTY DAMAGE CAN RESULT FROM THE USE OF WRONG AMMUNITION, BORE OBSTRUCTIONS, POWDER OVERLOADS, OR INCORRECT COMPONENTS!

22

Death, serious injury and damages can result from the use of wrong caliber ammunition. F.lli Pietta srl shall not be responsible for physical injury, death or damage to property resulting from the use of wrong ammunition.

23

Water, snow, mud, excess of lubricant oil or grease or any other material can obstruct the barrel of your gun and cause injury or fatality. ALWAYS check the barrel of your firearm for obstruction before loading and firing. If you observe any obstruction, IMMEDIATELY clean the gun to ensure your gun will function correctly and safely.



WARNING:

FAILURE TO WEAR EYE PROTECTION CAN RESULT IN EYE INJURY!

24

ALWAYS wear safety glasses while shooting to protect your eyes from injury by gun powder, hot gases, lubricant, dirt or metallic particles, carbon residue, sparks or other debris. Omit wearing safety glasses can cause injury to your eyes. ALWAYS wear safety glasses when disassembling and cleaning any gun to prevent the possibility of springs, spring tension parts, solvents, or other agents from entering and irritating your eyes.



WARNING:

EXPOSURE TO SHOOTING NOISE CAN RESULT IN PERMANENT HEARING LOSS!

25

ALWAYS use the due cautions. ALWAYS wear and encourage others near you to wear ear protection when shooting, especially on a range. Without ear protection, the noise from your gun, and other guns close to you, could leave a "ringing" in the ears for some time after firing. Repeated exposure to shooting noise could result in permanent hearing loss.

HANDLING WITH SAFETY MANUAL

The term "Single Action" means that the hammer of your revolver must be manually drawn **fully** rearward, or "cocked", before firing each shot. In the process of cocking your revolver, you should note that there are three separate hammer positions, each one having its purpose.

- 1 BASIC SAFETY AND "AT REST" CARRYING POSITION**
 Draw the hammer backward of about 1/4 "and you will feel the hammer "clicks" into its safety notch. (if you listen carefully, you can hear it). In doing this you are engaging its normal internal safety notch. Your revolver must be in this "at rest" position whenever you are not actually shooting (see fig. n°1).
 For instructions how to activate the two manual safeties of our versions of Single Action, see pag n°29, section "INSTRUCTIONS FOR THE USE OF THE MANUAL SAFETIES".

- 2 LOADING/UNLOADING (HALF COCK) POSITION**
 Draw the hammer back to the next second-notch position (you can also hear this click if you listen carefully). In doing this, you actually disengage the cylinder of your revolver and allow it to freely rotate in the direction of the loading gate. This permits you to load or unload your revolver when you open the loading/unloading gate on the right rear side of the frame (see fig. 2).

- 3 FIRING (FULL COCK) POSITION**
 Draw the hammer fully rearward to its full-cock notch. Make sure it clicks into this rearmost position. Your revolver is now ready to fire (see fig. 3).

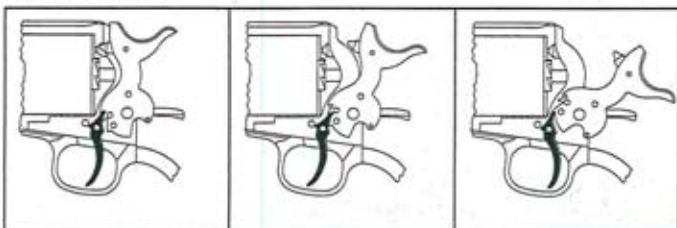

FIG. 1

FIG. 2

FIG. 3

CAUTION:

NEVER ATTEMPT TO FIRE YOUR REVOLVER IN ANY POSITION EXCEPT THE FULL-COCK POSITION. ATTEMPTING TO PULL THE TRIGGER IN THE SAFETY POSITION OR HALF-COCK POSITION WILL STRAIN THE MECHANISM AND POSSIBLY MAKE IT UNSAFE. (IT MIGHT EVEN BREAK IF YOU ARE STRONG ENOUGH).

INSTRUCTIONS FOR THE USE OF THE
MANUAL SAFETY

To activate the manual safety, place the hammer in the loading/unloading position. This way the cylinder will rotate freely.

- 1 Mod. n°1: Safety pin for S.A. 2nd Generation**
 Push the button that holds the cylinder pin (part n°3) towards the frame and push down the cylinder pin (part n°2) slightly down toward the hammer (part n°22). Release the button and keep pushing down the cylinder pin towards the hammer until the button will automatically come back in the initial position; this occurs because the button goes into the safety notch. If this does not happen, check that the cylinder pin has not been pushed too inside or that it is not slightly rotated and repeat the step, drawing back the cylinder pin.

MOD. 1

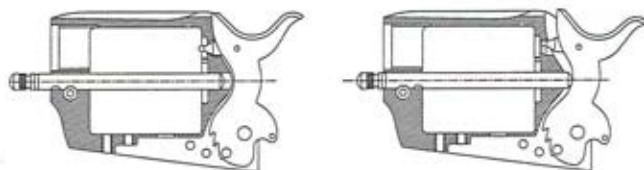

2 Mod. n°2: Safety Screw for S.A. Old model 1st Generation

Unscrew the screw that holds the cylinder pin. Then push the cylinder pin (part n°2) towards the hammer (the small depression in the cylinder pin is in line with the frame). Now, tighten the screw: the screw head must totally get into the frame as you found it at the beginning. The screw will stick against the cylinder pin. If the screw does not go down easily or the screw head is not totally inside in the frame, check the notch on the cylinder pin: the notch could be slightly up or down, or slightly rotated. The cylinder pin must be fixed.

After having performed these operations, cock the hammer. Holding the hammer with the thumb, and pulling the trigger with the forefinger, take the hammer against the cylinder pin. You'll see that the gap between the hammer and the frame is about 6/8mm.

MOD. 2

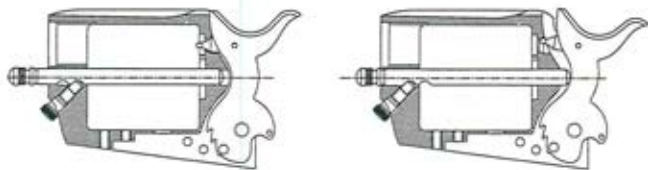
**COCKING WITH SAFETY TRANSFER BAR**

The term "Single Action" means that the hammer of your revolver with transfer bar must be manually drawn fully rearward, or "cocked", before firing each shot. In the process of cocking your revolver, you should note that there are two separate hammer positions, each one having its own purpose.

1 LOADING/UNLOADING POSITION (HALF COCK)

By pulling back the hammer of your transfer bar revolver, you will feel the hammer "click" into its first notch position (if you listen carefully, you can hear a click). In this position the cylinder of your revolver freely rotates clockwise. This allows you to load and unload your revolver by opening the gate that is located on the right rear side of the frame. (see position # 1)

FIRING POSITION

2 By pulling completely back the hammer you get to the firing full cock position. Make sure that the hammer is locked in this position !! Your revolver is now ready to fire. (see position # 2)

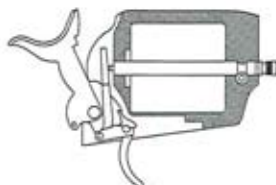

POSITION 1

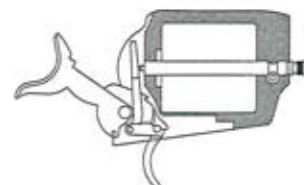

POSITION 2

**WARNING!**

NEVER ATTEMPT TO FIRE YOUR REVOLVER IN ANY OTHER POSITION THAN THE FULL COCK. ATTEMPTING TO PULL THE TRIGGER WHEN YOUR REVOLVER IS IN THE LOADING POSITION MAY DAMAGE THE MECHANISM AND MAKE THE GUN UNSAFE. (IF YOU ARE STRONG ENOUGH YOU MIGHT EVEN BREAK THE TRIGGER) THE STANDARD TRIGGER PULL WEIGHT IS MAX 1.5Kg/3.30 LBS.

INSTRUCTIONS FOR THE USE OF THE TRANSFER BAR SAFETY

The transfer bar mechanism allows you to load the cylinder's chambers in complete safety. It differs from the original one for the insertion of a lever that interposes between the hammer and the firing pin upon firing only when the trigger is actuated and logically when the hammer is cocked. This means that unless the trigger is pulled, the lever does not rise. The transfer bar mechanism provides maximum security against accidental discharge. It is an automatic safety always active. It consists in a lever (part # 109) connected to the trigger (part # 108) that interposes between the hammer (part # 104) and the firing pin (part # 101). When this lever is not activated, therefore only in case of accidental discharge, the hammer cannot hit the firing pin. The gun remains dangerous and must be treated with extreme caution even in the presence of an automatic safety as that fitted on this Pietta revolver.

It is a safety system that prevents firing also in case of accidental drops or in the event of trigger breakage. In traditional single-action revolvers the firing pin is directly linked to the hammer and it hits the cartridge primer every time the hammer falls on the loaded chamber. With the transfer bar mechanism the firing pin is independent from the hammer and thanks to this lever it transfers the hammer percussion time on the firing pin.



WARNING!

LIKE ALL SAFETY DEVICES THE TRANSFER BAR DOES NOT REPLACE THE SAFETY STANDARDS AND PROPER HANDLING. THE SAFEST WAY BY FAR TO KEEP OR CARRY ANY REVOLVER IS TO HAVE THE HAMMER UNCOCKED AND THE CARTRIDGE CHAMBER EMPTY



WARNING!

THE EXCESSIVE PRESSURE ON THE TRIGGER, WHEN THE HAMMER IS ON THE LOADING NOTCH, MAY DAMAGE OR BREAK THE TRIGGER AND CAN RESULT IN AN ACCIDENTAL DISCHARGE. THE STANDARD TRIGGER PULL WEIGHT IS MAX. 1.5 KG./3.30 LBS

SINGLE ACTION

HAMMER ON THE UNLOADED POSITION

After firing, the hammer remains in fully lowered position. In this position, if a cartridge is placed into the chamber in front of the hammer, the firing pin remains in contact with the cartridge primer for all the time the trigger is pulled (Fig. # 1). The transfer bar mechanism ensures that the firing pin gets in contact with the cartridge primer only if the hammer falls due to the activation of the trigger. When this latter is being released, the transfer bar lowers and disengages. This prevents the hammer from being in contact with the firing pin. (Fig. # 2)

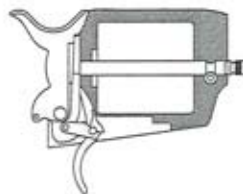

FIG.#1

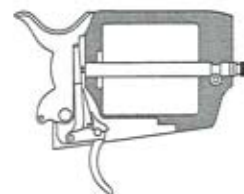

FIG.#2

HAMMER ON THE LOADING POSITION NOTCH

Pulling back the hammer in this position you will hear a net "click" when it engages to the loading position notch. This actually disengages the cylinder notches and allows the cylinder to rotate freely, allowing you to load or unload the revolver. (Fig. # 3)

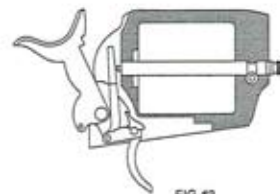

FIG.#3



WARNING!

THIS HAMMER POSITION IS NOT SAFE. FOLLOWING A BUMP THE HAMMER CAN FALL ON THE FIRING PIN AND CAUSE AN ACCIDENTAL DISCHARGE.

COCKED/FIRING POSITION HAMMER

Pulling back the hammer on the firing position you will hear a net "click" when fully cocked. The hammer is now in the firing position. Pulling the trigger will fire the revolver. (Fig. # 4)

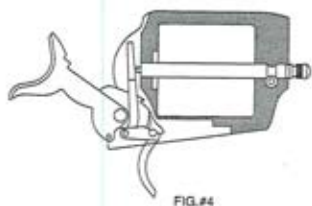

FIG.#4

WARNING!

MAKE SURE YOU ALWAYS HAVE THE GUN POINTED IN A SAFE DIRECTION. KEEP YOUR FINGER OFF THE TRIGGER AND OUTSIDE THE TRIGGER GUARD UNTIL YOU HAVE ALIGNED THE FRONT SIGHT AND REAR SIGHT ON A SAFE TARGET AND YOU ARE READY TO SHOOT

DECOCKING (UNCOCKING) THE REVOLVER

If you have your revolver in the full-cock position and change your mind and don't want to shoot, carefully follow these steps:

- 1 Make certain that the revolver is pointing in a safe direction.
- 2 Make certain both hands are dry and not impeded in any way-gloves, bandages, cold, etc.
- 3 Fully draw the hammer back with your thumb and continue holding it fully rearward while pulling the trigger backward. Hold the trigger and hammer back in this position.
- 4 While holding the trigger back, **slowly** lower the hammer downward, past its half-cock notch. **REMEMBER, YOU ARE LOWERING IT TOWARD A LIVE ROUND!** Be careful and keep it pointed in a safe direction.
- 5 When past the half-cock notch, release pressure on the trigger and take your finger out of the trigger guard.
- 6 Continue to lower the hammer to its safety notch position.

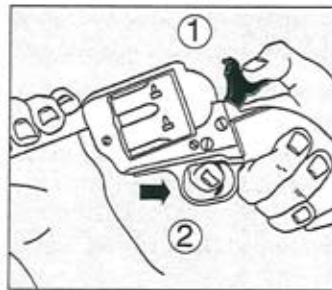

FIG. A

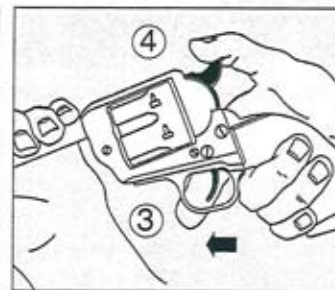

FIG. B

Fig. A - With the thumb controlling the hammer as shown above, (1) squeeze trigger to permit hammer to break free (2).

Fig. B - When hammer is free, immediately release trigger (3). Then lower hammer slowly to its resting position completely down against frame (4).



CAUTION:

YOU SHOULD PRACTICE THIS IMPORTANT GUN HANDLING SKILL WITH AN UNLOADED REVOLVER UNTIL YOU HAVE DEVELOPED THE PROPER CONTROL AND "TOUCH" TO DECOCK YOUR REVOLVER SAFELY.



CAUTION:

USE EXTREME CARE WHEN ATTEMPTING TO DECOCK THE REVOLVER. AS THE THUMB SLIPPLING DURING THIS PROCESS CAN RESULT IN AN ACCIDENTAL DISCHARGE IF THE TRIGGER IS HELD TO THE REAR.



CAUTION:

REMEMBER, WHEN YOU FULLCOCK YOUR REVOLVER TO SHOOT IT AGAIN, YOU ROTATE THE CYLINDER. WHEN YOU DECOCKED YOUR REVOLVER AND DECIDED NOT TO FIRE, THAT ROUND IS STILL LIVE IN THE CYLINDER AND WILL ROTATE BACK TOWARDS THE FIRING PIN POSITION WITH EACH COCKING.

DO NOT FORGET ABOUT THIS ROUND. If you fired rounds prior to the decocking operation and start firing again, the hammer will fall on one or more empty chambers and still will fall on the live round. **Be extremely careful of this live round.**

SINGLE ACTION

LOADING AND FIRING

Although the Single Action Revolvers are often referred to as "Six-shooters" it was customary in the Old West to only load five rounds in the gun and leave the chamber under the hammer empty. This is by far the safest way to load a single action revolver.



CAUTION:

WE STRICTLY RECOMMEND TO ONLY LOAD FIVE ROUNDS AND LEAVE THE CHAMBER UNDER THE FIRING PIN EMPTY. IF THE REVOLVER IS LOADED PROPERLY IN THIS MANNER, IT WOULD BE IMPOSSIBLE FOR THE GUN TO ACCIDENTALLY FIRE SHOULD IT BE DROPPED ON THE HAMMER.



CAUTION:

DO NOT LOAD THE REVOLVER UNTIL YOU ARE READY TO USE IT. READ SAFETY PRECAUTIONS. KEEP GUN POINTING IN A SAFE DIRECTION. ALWAYS KEEP YOUR FINGERS AWAY FROM THE TRIGGER WHENEVER YOU DO NOT INTEND TO FIRE.



WARNING!

USE ONLY FACTORY MADE AMMUNITION. THE MATERIALS OF THIS FIREARM HAVE BEEN SELECTED ACCORDING TO THE FACTORY MADE AMMUNITION PRESSURES. THE RIFLING AND THE CHAMBER SIZE OF THIS FIREARM HAVE BEEN SELECTED ACCORDING TO THE FACTORY MADE AMMUNITION SIZE.

1

Keeping your fingers out of the trigger guard and off the trigger, draw the hammer back to the half cock position which makes the cylinder free to rotate.

2

Open the loading gate as far as it will go. This will expose each chamber, one at a time, as you rotate the cylinder.

SINGLE ACTION

UNLOADING

CAUTION:

ALWAYS KEEP THE REVOLVER POINTED IN A SAFE DIRECTION. IF THE HAMMER IS COCKED IT MUST FIRST BE DECKED. DO NOT TOUCH TRIGGER AND ALWAYS KEEP HANDS AWAY FROM MUZZLE.

- 1 Draw the hammer to its half-cock position and open the loading gate on the right rear part of the frame.
- 2 Push out each cartridge or empty case with the ejector rod located under the barrel. Operate the ejector rod in each chamber to its full length to assure full length case ejection.
- 3 Check to be certain that all cartridges have been removed, then close the gate.

CAUTION:

DO NOT EJECT UNFIRED CARTRIDGES ONTO ANY SURFACES WHERE THE CARTRIDGE PRIMER MIGHT STRIKE A SOLID OBJECT AND DISCHARGE THE CARTRIDGE.

3 Make sure you have the exact caliber cartridges matching the exact caliber of the revolver. Then load one cartridge in each chamber.

4 Close the loading gate which, as you can see, becomes part of the recoil shield.

5 Place the hammer in the safety notch position by drawing it back slightly to disengage it from its half-cock notch position, carefully pull the trigger back, and, holding it back, allow the hammer to travel slowly forward but only far enough to pass its half-cock notch.

NOTE: You will not hear a click as the hammer moves through the half-cock notch. Then release the pressure on the trigger and continue to slowly lower the hammer forward until it clicks into its safety position. **AGAIN, YOU SHOULD PRACTICE THIS LOADING FUNCTION WITHOUT ANY CARTRIDGES UNTIL YOU ARE COMFORTABLE WITH HANDLING THE HAMMER AND ARE FAMILIAR WITH ITS RESPECTIVE NOTCHES.**

6 To fire the revolver, the hammer must first be manually cocked. When cocking the hammer, have a firm hold on the grip with the shooting hand and **DO NOT TOUCH THE TRIGGER WHILE COCKING THE HAMMER. TOUCH THE TRIGGER ONLY WHEN YOU ARE READY TO FIRE.** With the fore portion of your thumb firmly on the hammer spur, draw the hammer fully to the rear until it stops. Then permit the hammer to move backward slightly until the trigger engages in the hammer at full cock.

7 Once the hammer has been cocked, a light pressure on the trigger will disengage the trigger from the hammer. The hammer will fall forward and the revolver will fire.

After firing, the hammer will remain down. To fire subsequent shots, fully release the trigger and repeat steps 6 & 7 above for each shot.

CARE AND CLEANING

**CAUTION:**

ALWAYS MAKE SURE THE REVOLVER IS COMPLETELY UNLOADED BEFORE CLEANING. WEAR SAFETY GLASSES IN CASE YOU LOSE CONTROL OF SOME SPRING-LOADED COMPONENT WHICH COULD INJURE YOUR EYES.

At regular intervals or when the revolver has been exposed to sand, water or other adverse conditions, disassemble, clean and oil it.

Remove the cylinder using the following steps:

- 1** Open the loading gate.
- 2** Place the hammer in its half-cock notch.
- 3** Depress the base pin catch. This is the spring loaded plunger located on the left front side of the frame. Keep it depressed.
- 4** Slide the base pin all the way out. The base pin is the heavy pin around which the cylinder rotates (and provides a bearing surface for the cylinder). It should always be clean and lubricated.
- 5** Remove cylinder toward the loading gate. The cylinder is made to fit your revolver precisely and can be removed and replaced easily, but carefully. It is a close fit, so don't force it to move in any direction.

To reassemble, simply reverse the steps above.

When you reassemble the base pin, make sure the base pin catch snaps back in its regular position. You can test this by making sure the plunger is free to move when you depress it and it returns under its own spring pressure.

Use a wood, aluminum or brass cleaning rod (not steel), a brass bristle brush and patches appropriate to your revolver's caliber to clean it. Use a good quality cleaning solution to swab the bore and each cylinder. While swabbing the bore always brush all the way through the bore; never try to reverse direction while the brush is actually in the barrel or chamber. After swabbing, run clean patches through the bore and chambers until they come out clean. Then completely, but lightly, oil the entire revolver. Use a good quality brass polish on the backstrap and triggerguard (if made of brass). The brass parts are solid brass and, as such, will tarnish, reflecting their good quality. It is easily removed with any good quality brass polish.

**CAUTION:**

FIRING A REVOLVER WITH OIL, GREASE, OR ANY OTHER MATERIAL EVEN PARTIALLY OBSTRUCTING THE BORE MAY RESULT IN DAMAGE TO THE REVOLVER AND SERIOUS INJURY TO THE SHOOTER AND THOSE NEARBY. DO NOT SPRAY OR APPLY LUBRICANTS DIRECTLY ON AMMUNITION. IF THE POWDER CHARGE OF A CARTRIDGE IS AFFECTED BY THE LUBRICANT, IT MAY NOT BE IGNITED, BUT THE ENERGY FROM THE PRIMER MAY BE ENOUGH TO PUSH THE BULLET INTO THE BORE WHERE IT MAY BECOME LODGED. FIRING A SUBSEQUENT BULLET INTO THE OBSTRUCTED BORE MAY DAMAGE THE REVOLVER AND CAUSE SERIOUS INJURY OR DEATH TO THE SHOOTER AND THOSE NEARBY. USE LUBRICANTS PROPERLY. YOU ARE RESPONSIBLE FOR THE PROPER CARE AND MAINTENANCE OF YOUR FIREARM.

STORAGE

Always unload your gun and store it and ammunition separately in a locked receptacle out of children's reach and sight, minimizing the risk that the gun and ammunition could be easily available for loading and firing.

USE YOUR REVOLVER CAREFULLY AND SAFELY.

**WARNING:**

www.pietta.it

**UNLOAD MANUALS' UPDATES
FROM OUR SITE**

**PLEASE HAVE A LOOK AT OUR WEBSITE
FOR ORIGINAL F.LLI PIETTA
SPARE PARTS DISTRIBUTORS**

LEAD EXPOSURE**REDUCING EXPOSURE:**

Lead contamination in the air, in dust and on your skin is invisible. **Keep children and pregnant women away** during use and until cleanup is complete. Risk can be reduced-but not eliminated- with strong ventilation; washing hands immediately after use of these products before eating or smoking and careful cleaning of surfaces and floors with disposable wipes, after lead dust has had a chance to settle. Use a lead specific cleaner with EDTA or a high-phosphate detergent (like most detergents sold for electric dishwashers) and big wipes for disposal.

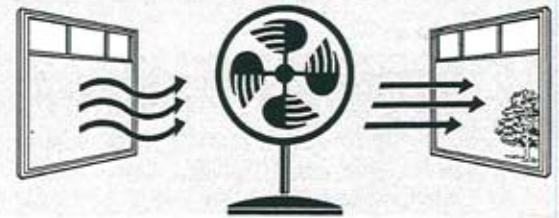

Use strong ventilation

Discharging firearms in poorly ventilated areas, cleaning firearms or handling ammunition may result in exposure to lead and other substances known to the State of California to cause birth defects, reproductive harm and other serious physical injury. Have adequate ventilation at all times. Wash hands thoroughly after exposure. Shooting or cleaning guns may expose you to lead.

STATE WARNINGS

Certain states require by law that the manufacturer, distributor, or retail dealer provide specific-warning notices with firearms sold in that state. To comply with these laws and regulations, F.LLI Pietta includes the following warnings:



WARNING:

"CHILDREN ARE ATTRACTED TO AND CAN OPERATE FIREARMS THAT CAN CAUSE SEVERE INJURIES OR DEATH. PREVENT CHILD ACCESS BY ALWAYS KEEPING GUNS LOCKED AWAY AND UNLOADED WHEN NOT IN USE. IF YOU KEEP A LOADED FIREARM WHERE A CHILD OBTAINS AND IMPROPERLY USES IT, YOU CAN BE FINED OR SENT TO PRISON."



WARNING:

"A LOS NIÑOS LOS ATRAEN LAS ARMAS DE FUEGO Y LAS PUEDEN HACER FUNCIONAR. ELLOS PUEDEN CAUSARSE LESIONES GRAVES Y LA MUERTE. EVITE QUE LOS NIÑOS TENGAN ACCESO A LAS ARMAS DE FUEGO GUARDÁNDOLAS SIEMPRE CON LLAVE Y DESCARGADAS CUANDO NO LAS ESTÉ UTILIZANDO. SI USTED TIENE UN ARMA DE FUEGO CARGADA EN UN LUGAR EN QUE UN NIÑO TIENE ACCESO A ELLA Y LA USA INDEBIDAMENTE, LE PUEDEN DAR UNA MULTA O ENVIARLO A LA CARCEL."

Connecticut:

"UNLAWFUL STORAGE OF A LOADED FIREARM MAY RESULT IN IMPRISONMENT OR FINE."

Florida:

"IT IS UNLAWFUL, AND PUNISHABLE BY IMPRISONMENT AND FINE, FOR ANY ADULT TO STORE OR LEAVE A FIREARM IN ANY PLACE WITHIN THE REACH OR EASY ACCESS OF A MINOR UNDER 18 YEARS OF AGE OR TO KNOWINGLY SELL OR OTHERWISE TRANSFER OWNERSHIP OR POSSESSION OF A FIREARM TO A MINOR OR A PERSON OF UNSOUND MIND."

Maine:

"ENDANGERING THE WELFARE OF A CHILD IS A CRIME. IF YOU LEAVE A FIREARM AND AMMUNITION WITHIN EASY ACCESS OF A CHILD, YOU MAY BE SUBJECT TO FINE, IMPRISONMENT OR BOTH. KEEP FIREARMS AND AMMUNITION SEPARATE. KEEP FIREARMS AND AMMUNITION LOCKED UP. USE TRIGGER LOCKS."

Maryland:

"WARNING: CHILDREN CAN OPERATE FIREARMS WHICH MAY CAUSE DEATH OR SERIOUS INJURY. IT IS A CRIME TO STORE OR LEAVE A LOADED FIREARM IN ANY LOCATION WHERE AN INDIVIDUAL KNEW OR SHOULD HAVE KNOWN THAT AN UNSUPERVISED MINOR WOULD GAIN ACCESS TO THE FIREARM. STORE YOUR FIREARM RESPONSIBLY!"

Massachusetts:

"WARNING FROM THE MASSACHUSETTS ATTORNEY GENERAL: THIS HANDGUN IS NOT EQUIPPED WITH A DEVICE THAT FULLY BLOCKS USE BY UNAUTHORIZED USERS. MORE THAN 200,000 FIREARMS LIKE THIS ONE ARE STOLEN FROM THEIR OWNERS EVERY YEAR IN THE UNITED STATES. IN ADDITION, THERE ARE MORE THAN A THOUSAND SUICIDES EACH YEAR BY YOUNGER CHILDREN AND TEENAGERS WHO GET ACCESS TO FIREARMS. HUNDREDS MORE DIE FROM ACCIDENTAL DISCHARGE. IT IS LIKELY THAT MANY MORE CHILDREN SUSTAIN SERIOUS WOUNDS, OR INFLICT SUCH WOUNDS ACCIDENTALLY ON OTHERS. IN ORDER TO LIMIT THE CHANCE OF SUCH MISUSE, IT IS IMPERATIVE THAT YOU KEEP THIS WEAPON LOCKED IN A SECURE PLACE AND TAKE OTHER STEPS NECESSARY TO LIMIT THE POSSIBILITY OF THEFT OR ACCIDENT. FAILURE TO TAKE REASONABLE PREVENTIVE STEPS MAY RESULT IN INNOCENT LIVES BEING LOST, AND IN SOME CIRCUMSTANCES MAY RESULT IN YOUR LIABILITY FOR THESE DEATHS."

"IT IS UNLAWFUL TO STORE OR KEEP A FIREARM, RIFLE, SHOTGUN OR MACHINE GUN IN ANY PLACE UNLESS THAT WEAPON IS EQUIPPED WITH A TAMPER-RESISTANT SAFETY DEVICE OR IS STORED OR KEPT IN A SECURELY LOCKED CONTAINER."



New Jersey:

"IT IS A CRIMINAL OFFENSE TO LEAVE A LOADED FIREARM WITHIN EASY ACCESS OF A MINOR."

New York City:

"THE USE OF A LOCKING DEVICE OR SAFETY LOCK IS ONLY ONE ASPECT OF RESPONSIBLE WEAPONS STORAGE. ALL WEAPONS SHOULD BE STORED UNLOADED AND LOCKED IN A LOCATION THAT IS BOTH SEPARATE FROM THEIR AMMUNITION AND INACCESSIBLE TO CHILDREN AND ANY OTHER UNAUTHORIZED PERSONS."

North Carolina:

"IT IS UNLAWFUL TO STORE OR LEAVE A FIREARM THAT CAN BE DISCHARGED IN A MANNER THAT A REASONABLE PERSON SHOULD KNOW IS ACCESSIBLE TO A MINOR."

Texas:

"IT IS UNLAWFUL TO STORE, TRANSPORT, OR ABANDON AN UNSECURED FIREARM IN A PLACE WHERE CHILDREN ARE LIKELY TO BE AND CAN OBTAIN ACCESS TO THE FIREARM."

Wisconsin:

"IF YOU LEAVE A LOADED FIREARM WITHIN THE REACH OR EASY ACCESS OF A CHILD YOU MAY BE FINED OR IMPRISONED OR BOTH IF THE CHILD IMPROPERLY DISCHARGES, POSSESSES, OR EXHIBITS THE FIREARM."

Please also check with your licensed retailer or state police for additional warnings which may be required by local law or regulation. Because such regulations are subject to change, local authorities are in the best position to advise you on such legal matters.

NOMENCLATURA-NOMENCLATURE

1873 SINGLE ACTION OLD MODEL, 1ST GENERATION

1 CASTELLO FRAME	16 TUBETTO ESPULSORE EJECTOR HOUSING	30 VITE CANE HAMMER SCREW	47 VITE SICURA MANUALE MANUAL SAFETY SCREEN
2 PERNO CASTELLO BASE PIN	17 VITE FISSAG. TUBETTO ESPULSORE EJECTOR HOUSING SCREW	31 GRILLETTO TRIGGER	48 GUIDA MOLLA RICHIAMO LEVA ROTAZIONE TAMBURRO BOLT RECALL SPRING GUIDE
6 TUBETTO GUIDA TAMBURRO BASE PIN BUSHING	18 BUSSOLA ANCORAGGIO TUB. ESP. EJECTOR HOUSING SCREW BUSHING	32 NOTTOLINO BOLT	49 MOLLA RICHIAMO LEVA ROTAZIONE TAMBURRO BOLT RECALL SPRING
7 TAMBURRO CYLINDER	19 MANETTINO ESPULSORE EJECTOR HEAD	33 MOLLA GRILLETTO/NOTTOLINO TRIGGER & BOLT SPRING	50 INSERTO BASCULA FIRING PIN RECOIL SHIELD
8 SOTTOGUARDIA TRIGGER GUARD	20 ASTA ESPULSORE EJECTOR ROD	34 VITE DEL GRILLETTO TRIGGER SCREW	
9 FASCETTA BACKSTRAP	21 MOLLA ESPULSORE EJECTOR SPRING	35 VITE DEL NOTTOLINO BOLT SCREW	
10 SPORTELLO GATE	22 CANE HAMMER	36 VITE MOLLA GRILLETTO TRIGGER SPRING SCREW	
11 PERNO CONTRASTO SPORTELLO GATE CATCH	23 SPINA PERCUSSORE FIRING PIN RIVET	37 MOLLA CANE MAINSRING	
12 MOLLA PERNO SPORTELLO GATE SPRING	24 PERCUSSORE FIRING PIN	38 VITE MOLLA CANE MAINSRING SCREW	
13 GRANO SPORTELLO GATE CATCH SCREW	25 SPINA RONDELLA CANE HAMMER ROLLER PIN	39 VITE FASCETTA/SOTT. LUNGA BACKSTRAP REAR SCREW	
14 CANNA BARREL	26 RONDELLA CANE HAMMER ROLLER	41 VITE FASCETTA/SOTT. CORTA BACKSTRAP FRONT SCREW	
15 MIRINO FRONT SIGHT	28 LEVA ROTAZIONE TAMBURRO HAND	42 GUANCINA GRIP	

SI PREGA DI SPECIFICARE SEMPRE IL CALIBRO E IL TIPO DI FINITURA DELL'ARMA.

WHEN PLACING YOUR ORDER FOR SPARE PARTS, PLEASE MENTION THE REFERENCE CODE AND CALIBER OF THE GUN.

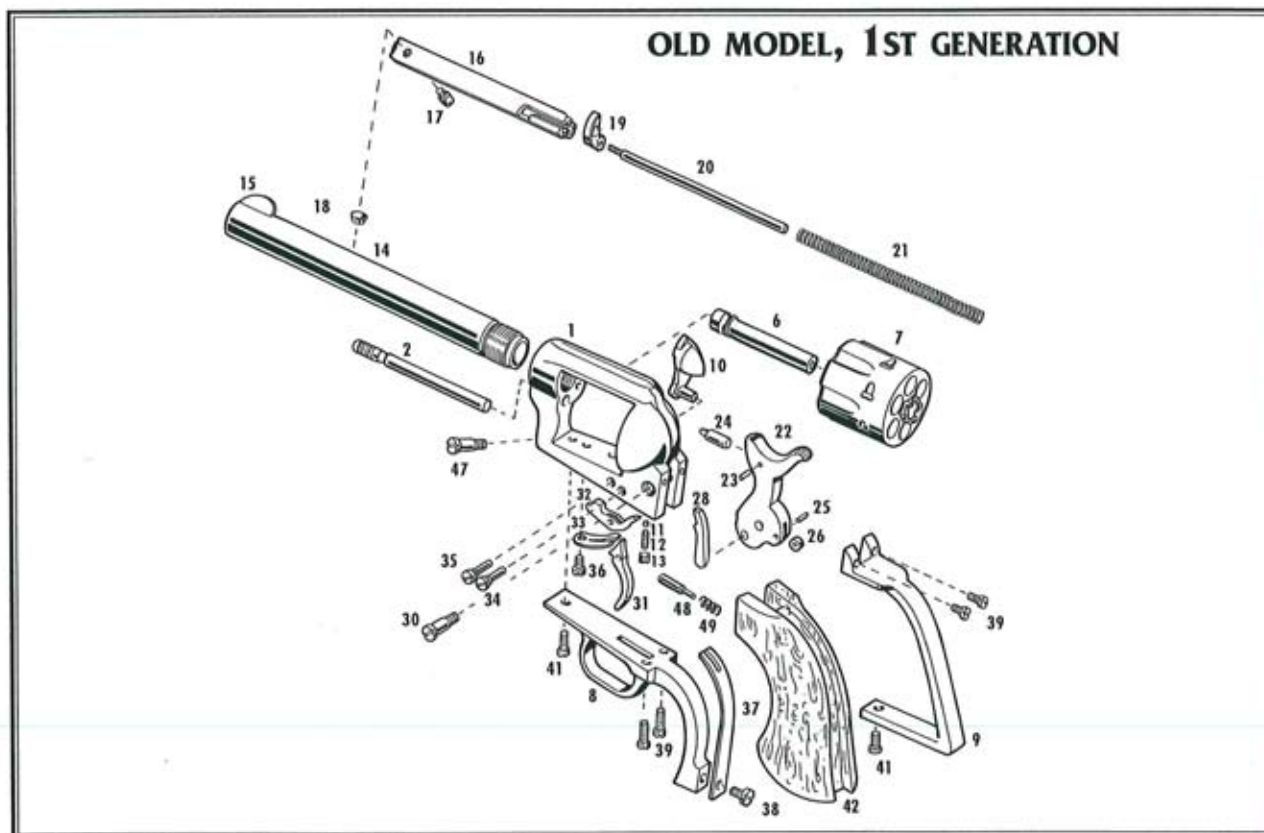

1873 SINGLE ACTION, 2ND GENERATION

1 CASTELLO FRAME	13 GRANO SPORTELO GATE CATCH SCREW	25 SPINA RONDELLA CANE HAMMER ROLLER PIN	39 VITE FASCETTA/SOTT. LUNGA BACKSTRAP REAR SCREW
2 PERNO CASTELLO BASE PIN	14 CANNA BARREL	26 RONDELLA CANE HAMMER ROLLER	41 VITE FASCETTA/SOTT. CORTA BACKSTRAP FRONT SCREW
3 PERNO BLOCCAGGIO PERNO CAST. BASE PIN LATCH	15 MIRINO FRONT SIGHT	28 LEVA ROTAZIONE TAMBURO HAND	42 GUANCINA GRIP
4 TESTA FILETTATA BASE PIN LATCH NUT	16 TUBETTO ESPULSORE EJECTOR HOUSING	30 VITE CANE HAMMER SCREW	48 GUIDA MOLLA RICHIAMO LEVA ROTAZIONE TAMBURO BOLT RECALL SPRING GUIDE
5 MOLLA PULSANTE PERNO BASE PIN LATCH SPRING	17 VITE FISSAG. TUBETTO ESPULSORE EJECTOR HOUSING SCREW	31 GRILLETTO TRIGGER	49 MOLLA RICHIAMO LEVA ROTAZIONE TAMBURO BOLT RECALL SPRING
6 TUBETTO GUIDA TAMBURO BASE PIN BUSHING	18 BUSSOLA ANCORAGGIO TUB. ESP. EJECTOR HOUSING SCREW BUSHING	32 NOTTOLINO BOLT	50 INSERTO BASCULA FIRING PIN RECOIL SHIELD
7 TAMBURO CYLINDER	19 MANETTINO ESPULSORE EJECTOR HEAD	33 MOLLA GRILLETTO/NOTTOLINO TRIGGER & BOLT SPRING	
8 SOTTOGUARDIA TRIGGER GUARD	20 ASTA ESPULSORE EJECTOR ROD	34 VITE DEL GRILLETTO TRIGGER SCREW	
9 FASCETTA BACKSTRAP	21 MOLLA ESPULSORE EJECTOR SPRING	35 VITE DEL NOTTOLINO BOLT SCREW	
10 SPORTELO GATE	22 CANE HAMMER	36 VITE MOLLA GRILLETTO TRIGGER SPRING SCREW	
11 PERNO CONTRASTO SPORTELO GATE CATCH	23 SPINA PERCUSSORE FIRING PIN RIVET	37 MOLLA CANE MAINSRING	
12 MOLLA PERNO SPORTELO GATE SPRING	24 PERCUSSORE FIRING PIN	38 VITE MOLLA CANE MAINSRING SCREW	

SI PREGA DI SPECIFICARE SEMPRE IL CALIBRO E IL TIPO DI FINITURA DELL'ARMA.

WHEN PLACING YOUR ORDER FOR SPARE PARTS, PLEASE MENTION THE REFERENCE CODE AND CALIBER OF THE GUN.

2ND GENERATION

