



TROY®



Carbine

All TROY 5.56 Carbine and Rifles

OPERATOR'S MANUAL

FOREWORD

Important operating instructions for:

TROY Carbines and Rifles

If you have any questions or comments regarding your new firearm, please contact us.

TROY, 866-788-6412

WorldOfTROY.com

Please use the space below to record information about your new firearm.

Model _____

Serial Number _____

Purchased From _____

Date of Purchase _____

TABLE OF CONTENTS

	PG
1: FOREWORD.....	4
2: CONTENTS OF THE SHIPPING CONTAINER.....	4
3: WARRANTY AND NOTE.....	4
4: PRECAUTIONS.....	7
5: SAFE HANDLING AND OPERATION.....	9
6. SAFE STORAGE AND TRANSPORTATION.....	12
7: AMMUNITION.....	13
8: STATE BY STATE WARNINGS.....	13

TABLE OF CONTENTS CONTINUED

DESCRIPTION AND OPERATION

	PG
9. FUNCTIONAL INSPECTION	15
10. OPERATING THE SAFETY SELECTOR.....	15
11. OPERATING THE BOLT CATCH	18
12. LOADING YOUR FIREARM WITH A MAGAZINE	20
13. SAFE FIRING.....	22
14. UNLOADING	26
15. CLEARING MISFIRES.....	27
16. DISASSEMBLY	29
17. ASSEMBLY	32
18. SIGHTS	34
19. MOUNTING ACCESSORIES.....	37
20. BATTLEAX™ STOCK OPERATION.....	38
21. TOMAHAWK™ STANDARD STOCK OPERATION.....	40
22. TROY PDW STOCK AND TOMAHAWK SHORT OPERATION	42
23. CLEANING AND UPKEEP	44
24. TAKING CARE OF THE FIREARM	45
25. CONTACT INFORMATION	46

1. FOREWORD

We are pleased that you have chosen TROY. TROY products combine the latest in manufacturing and testing methods for a civilian firearm. TROY carbines and rifles represent the highest levels of reliable function, accuracy, ergonomics, precision, reliability and safety expected from a TROY firearm.

Utilitarian in design, TROY Products are very easy to maintain. With a reasonable amount of care, your Firearm will last for years to come.

To take maximum advantage of the many features of your firearm, regularly review this operator's manual. Please contact us if you have any observations or questions regarding the performance or the operation of your firearm.

Thank you.

2. CONTENTS OF THE SHIPPING CONTAINER

Your Firearm and its accessories are shipped with:

- One TROY firearm
- One TROY 30-round magazine
(One 10 round in Compliant States)
- Operator's Manual

3. WARRANTY NOTES

All TROY products are manufactured in the USA using the finest quality materials.

WHO AND WHAT IS COVERED BY THIS WARRANTY AND FOR HOW LONG?

TROY® warrants to you, the original purchaser of a new TROY product with proof of purchase, that for one year from the date of purchase, your TROY product will be free from defects in material and workmanship.

WHAT WILL TROY DO IF YOU DISCOVER A DEFECT?

If you make a claim within the warranty period following the instructions given in this warranty, we will, at our option, repair the defect(s), or replace the product at no cost to you. If we send you a new product, we will keep the defective one. TROY will determine, in its sole and exclusive discretion, whether to repair or replace a product, part or component. TROY also reserves the right to determine the means and materials by which such repair or replacement will be made.

All defective product returns must be pre-authorized by TROY customer service and be accompanied by a Return Material Authorization (“RMA”) Number. You must contact customer service to receive a RMA Number prior to returning any product. You must have your original purchase paperwork, including your receipt or other proof of purchase and be willing to provide these documents to TROY.

WHAT IS NOT COVERED?

This limited warranty does not cover personal injury, property damage, and/or damage caused by:

- Failure to follow the Instructions provided with the product;
- Improper maintenance or negligence;
- Alterations or modifications made to the product without the expressed written authorization of TROY®;
- Normal wear and tear;
- Accidental discharge, careless handling, and/or misuse;
- Handloaded, reloaded, or improper ammunition;
- Barrel obstructions.

There are no warranties which extend beyond the description above. The sole and exclusive remedy pursuant to this warranty is the repair or replacement of your TROY® product. The implied warranties of merchantability and fitness for a particular purpose are expressly disclaimed. All disclaimers and limitations of liability shall still apply even if the limited remedy of repair and replacement fails of its essential purpose. In states where permitted, TROY® assumes no liability for incidental or consequential damage or for incidental expenses. Any action against TROY® based on an alleged breach of this warranty must be brought within one (1) year of the claimed breach.



WARNING:

**BEFORE USING THIS FIREARM, READ AND FOLLOW
THE INSTRUCTIONS IN THIS MANUAL**

If there is anything you do not understand - DO NOT USE THIS FIREARM until you get help from someone qualified in the safe handling of firearms.

COPYRIGHT AND TRADEMARK. The TROY name, design, logos and related marks are registered trademarks of TROY Industries, Inc. All rights reserved.

Unless otherwise noted, this Manual (including text, photographs, images, illustrations, and graphics) are protected as the copyrights, trade dress, trademarks and/or other intellectual properties owned by TROY Industries, Inc. and/or its subsidiaries and affiliates or by other parties that have licensed their material to TROY Industries. Additionally, this Manual itself is protected by copyright as a collective work and/or compilation.

TROY Industries, Inc.'s marks in this Manual represent some of the marks currently owned or controlled in the United States and/or in one or more other countries by TROY Industries, Inc. The display of these marks and of notices associated with these marks is not intended to be a comprehensive compilation of all TROY Industries, Inc. worldwide proprietary ownership rights, and TROY Industries, Inc. may own or control other proprietary rights in one or more countries outside of the United States.

© 2021 TROY Industries, Inc. All Rights Reserved.

This instruction manual is for the TROY 5.56 Carbines and Rifles and must always accompany this firearm. In this Manual, we refer to your new firearm as “this firearm”, “rifle” or “this carbine”. This carbine is manufactured by TROY; in this Manual we will refer to TROY as “TROY”, “we” and “our”.

Proper care and use of this carbine is required. This manual is written to assist you in doing so.

For support on this firearm model please call: **866-788-6412.**

4. PRECAUTIONS

READ AND UNDERSTAND ALL THE FOLLOWING PRECAUTIONS BEFORE REMOVING THIS FIREARM FROM ITS PACKAGE.

This firearm is classified by the Bureau of Alcohol, Tobacco and Firearms (BATF) a part of the Department of Justice., as a firearm or dangerous weapon: it is, potentially lethal!

 **WARNING:** IF THIS FIREARM IS CARELESSLY OR IMPROPERLY HANDLED, UNINTENTIONAL DISCHARGE COULD RESULT AND COULD CAUSE SERIOUS INJURY, DEATH, OR DAMAGE TO PROPERTY.

 **WARNING:** DO NOT CHANGE OR MODIFY THIS FIREARM IN ANY MANNER. THIS FIREARM IS DESIGNED AND MANUFACTURED TO OPERATE AS CONFIGURED BY TROY®. SUBSTITUTING PARTS AND MODIFYING THE WEAPON MAY CAUSE IT NOT TO FUNCTION AS INTENDED AND RESULT IN SERIOUS INJURY, DEATH, OR DAMAGE TO PROPERTY.

 **CAUTION:** CAREFULLY READ THIS INSTRUCTION MANUAL PRIOR TO LOADING AND FIRING. THIS INSTRUCTION MANUAL GIVES BASIC ADVICE ON THE PROPER HANDLING, USE AND FUNCTIONING OF THIS FIREARM.

Your safety and the safety of others (including your family) depends on your understanding of and complete compliance with the instructions in this manual. You must follow the instructions provided in this Manual at all times. If you are unfamiliar with firearms or do not understand something in this manual - DO NOT USE THIS FIREARM, and seek training and advice through a safe handling course run by your local gun club or an instructor approved by the National Rifle Association (NRA) or similar qualified organization.

4. PRECAUTIONS (CONTINUED)

NOTICE: TROY shall not be responsible for injury, death, or damage to property resulting from either intentional or accidental discharge of this firearm, or from its function when used for purposes for which it is not designed, for unlawful purposes, or when subjected to treatment for which it was not designed. TROY® will not honor claims involving this firearm which result from careless or improper handling, unauthorized changes, modifications, or adjustments to this firearm, the unauthorized installation of parts, replacement parts or accessories, corrosion, neglect, or the use of wrong caliber ammunition, or the use of ammunition other than original high quality commercially manufactured ammunition in good condition, or any combination thereof. TROY will not honor claims involving this firearm for any reason or cause when such claims are made by the second or subsequent owner.

IMPORTANT!

BEFORE THIS FIREARM LEFT THE FACTORY, IT WAS CAREFULLY ASSEMBLED, INSPECTED, TESTED, AND PACKAGED. WE CANNOT CONTROL HOW THE FIREARM WAS HANDLED AFTER IT LEFT OUR FACTORY; THEREFORE, YOU SHOULD EXAMINE THIS FIREARM CAREFULLY AT THE TIME OF PURCHASE TO ENSURE THAT IT IS UNLOADED AND UNDAMAGED.

THIS INSTRUCTION MANUAL MUST ALWAYS ACCOMPANY THIS FIREARM.

4. PRECAUTIONS (CONTINUED)



CAUTION: CAREFULLY READ THIS INSTRUCTION MANUAL. THIS INSTRUCTION MANUAL GIVES BASIC ADVICE ON THE PROPER HANDLING, USE AND FUNCTIONING OF THIS FIREARM.

GENERAL INFORMATION:

This firearm is a gas operated, magazine fed, auto-loading carbine or rifle. It consists of the lower receiver/trigger group and the upper receiver with bolt carrier group and stock assembly. Its relatively few parts make it a trustworthy firearm.

5. SAFE HANDLING AND OPERATION



CAUTION: YOU MUST PROPERLY HANDLE THIS FIREARM AT ALL TIMES. IT IS YOUR RESPONSIBILITY TO MAKE SURE THAT ALL SAFETY MEASURES ARE TAKEN.



CAUTION: YOU MUST ALWAYS SECURE THIS FIREARM AWAY FROM CHILDREN AND PERSONS WHO ARE NOT PERMITTED TO USE THIS FIREARM. YOU ARE RESPONSIBLE FOR SAFELY STORING THIS FIREARM IN ACCORDANCE WITH ALL APPLICABLE LAWS. AT A MINIMUM, YOU MUST PROPERLY LOCK THIS FIREARM AND ENSURE THAT CHILDREN AND UNPERMITTED PERSONS CANNOT ACCESS THIS FIREARM.



WARNING: THE MECHANICAL AND FUNCTIONAL FEATURES ON THIS FIREARM SUCH AS THE SAFETY CANNOT ENSURE YOUR SAFETY OR THE SAFETY OF OTHERS. IT IS YOUR SAFE FIREARM HANDLING HABITS THAT WILL ENSURE YOUR SAFETY AND THE SAFETY OF OTHERS WHEN TRANSPORTING, USING, MAINTAINING AND STORING THIS FIREARM.

5. SAFE HANDLING AND OPERATION (CONTINUED)

 **WARNING:** WHEN STORING YOUR FIREARM, NEVER STORE AMMUNITION IN THE SAME LOCATION AS YOUR FIREARM.

 **WARNING:** YOU AND ANY PERSON HANDLING THIS FIREARM MUST BE COMPLETELY FAMILIAR WITH SAFE HANDLING PROCEDURES AND HOW THIS FIREARM OPERATES BEFORE HANDLING IT. FAILURE TO DO SO COULD RESULT IN THE ACCIDENTAL DISCHARGE OF A BULLET OR OTHER COMPONENT CAUSING SERIOUS INJURY OR DEATH OR DAMAGE TO PROPERTY.

 **WARNING:** NEVER PUT YOUR FINGER OR ANY OBJECT ON THIS FIREARM'S TRIGGER OR TRIGGER GUARD UNLESS YOU INTEND TO FIRE.

 **WARNING:** YOU MUST ALWAYS BE ABLE TO CLEARLY SEE AND IDENTIFY YOUR TARGET. YOU MUST ALWAYS KNOW WHAT IS AROUND AND BEYOND YOUR TARGET. You must always know exactly where your bullet is going to strike, even when dry firing. You must only shoot where there is a backstop free of obstructions. Do not shoot in the air. Do not aim at objects that may cause the bullet to ricochet, such as water, rocks and hard surfaces. When hunting you must always be able to clearly see and identify your target: do not fire at a movement or a noise.

 **WARNING:** DO NOT RUN, JUMP, CLIMB, HORSEPLAY OR ROUGH HOUSE WHILE CARRYING THIS FIREARM.

 **WARNING:** KEEP YOUR FACE AND HANDS AWAY FROM THE BOLT CARRIER WHEN FIRING. THE BOLT CARRIER OPENS AND CLOSSES RAPIDLY WHEN FIRING. HOT BRASS AND POWDER GAS CAN EJECT AND BURN YOU, THIS FIREARM SHOULD BE FIRED FROM THE RIGHT SHOULDER.

 **WARNING:** ALWAYS USE THE CORRECT AMMUNITION FOR THIS FIREARM. NEVER USE AMMUNITION THAT HAS BEEN "HANDLOADED", IS NON-STANDARD, RELOADED, OR HAS NOT BEEN TESTED AND SUBJECTED TO BALLISTIC PRESSURE TESTING.

5. SAFE HANDLING AND OPERATION (CONTINUED)

 **WARNING:** ANY ACCESSORIES USED IN OR ON THIS FIREARM MUST BE COMPATIBLE WITH TROY'S SPECIFICATIONS; THIS INCLUDES HARNESES AND CASES. You must make sure that any compatible accessories for this firearm do not hinder the use of any of the safety devices.

 **WARNING:** YOU MUST CHECK THE BARREL FOR OBSTRUCTIONS BEFORE FIRING THIS FIREARM. COMMON OBSTRUCTIONS INCLUDE, BUT ARE NOT LIMITED TO MUD, SNOW, AND ANY OTHER OBJECT WHICH MAY HAVE ACCIDENTALLY BEEN PLACED IN THE BARREL. OBSTRUCTIONS IN THE BARREL CAN CAUSE DAMAGE TO THIS FIREARM AND COULD CAUSE SERIOUS INJURY OR DEATH TO YOU OR OTHERS. DO NOT LOOK UP THE MUZZLE TO CHECK THE BARREL.

 **WARNING:** IF THIS FIREARM IS DROPPED OR STRUCK WHILE LOADED IT MAY DISCHARGE. ALWAYS KEEP THIS FIREARM UNLOADED AND THE CHAMBER EMPTY UNTIL YOU INTEND TO FIRE IT.

 **WARNING:** ALWAYS REMOVE ANY MAGAZINE AND AMMUNITION FROM THIS FIREARM'S CHAMBER WHEN YOU HAVE FINISHED SHOOTING. After shooting this firearm for a sustained period of time, "cook-off" can take place. "Cook-off" is when the firearm remains at an excessively high temperature, potentially causing ammunition in the firearm to inadvertently discharge. This can occur for an extended period of time even after you have stopped firing this firearm.

 **WARNING:** BE SURE THAT ADEQUATE VENTILATION IS ALWAYS AVAILABLE. WHEN USING FIREARMS IN AN AREA THAT IS NOT WELL VENTILATED, LEAD EXPOSURE AND EXPOSURE TO OTHER HARMFUL SUBSTANCES MAY OCCUR. EXPOSURE TO LEAD CAN CAUSE BIRTH DEFECTS, REPRODUCTIVE HARM, AND OTHER SERIOUS PHYSICAL ALIMENTS TO YOURSELF OR OTHERS.

 **WARNING:** DO NOT USE THIS FIREARM WHILE UNDER THE INFLUENCE OF ALCOHOL OR DRUGS. DRUGS AND ALCOHOL MAY IMPAIR YOUR JUDGMENT AND COORDINATION.

 **WARNING:** YOU MAY ONLY USE THIS FIREARM FOR LAWFUL PURPOSES.

5. SAFE HANDLING AND OPERATION (CONTINUED)

 **WARNING:** ALWAYS WEAR SHOOTING SAFETY GLASSES AND WHEN HANDLING THIS FIREARM, INCLUDING BUT NOT LIMITED TO WHEN YOU ARE ASSEMBLING, DISASSEMBLING, CLEANING, TRANSPORTING OR FIRING THIS FIREARM OR ANY ACCESSORIES FOR COMPONENTS TO THIS FIREARM. ANY OTHER PERSONS NEARBY MUST WEAR SAFETY GLASSES AND EAR PROTECTION AS WELL.

 **CAREFUL:** THE MUZZLE OF THE FIREARM WILL BECOME EXTREMELY HOT DURING FIRING.

6. SAFE STORAGE AND TRANSPORTATION

NEVER STORE OR TRANSPORT A LOADED FIREARM!

 **WARNING:** WARNING: WHEN TRANSPORTING THIS FIREARM YOU MUST MAKE SURE THAT IT IS UNLOADED. YOU MUST MAKE SURE THIS FIREARM IS UNLOADED BEFORE BEING PLACED IN A VEHICLE. A FIREARM CARRYING CASE SHOULD BE USED TO TRANSPORT THIS FIREARM TO AND FROM A SHOOTING AREA.

 **CAUTION:** YOU MUST ALWAYS SECURE THIS FIREARM AWAY FROM CHILDREN AND PERSONS WHO ARE NOT PERMITTED TO USE THIS FIREARM. YOU ARE RESPONSIBLE FOR SAFELY STORING THIS FIREARM IN ACCORDANCE WITH ALL APPLICABLE LAWS. AT A MINIMUM, YOU MUST PROPERLY LOCK THIS FIREARM AND ENSURE THAT CHILDREN AND PERSONS CANNOT ACCESS THIS FIREARM.

 **WARNING:** NEVER STORE AMMUNITION IN THE SAME LOCATION AS THIS FIREARM. Never store this firearm in a leather case or anywhere it may be exposed to moisture. Moisture can damage this firearm.

7. AMMUNITION



WARNING: ALWAYS USE THE CORRECT AMMUNITION FOR THIS FIREARM. NEVER USE AMMUNITION THAT HAS BEEN “HANDLOADED”, IS NON-STANDARD, RELOADED, OR HAS NOT BEEN SUBJECTED TO BALLISTIC PRESSURE TESTING. USING THE WRONG AMMUNITION, INCORRECT CARTRIDGE COMPONENTS, OR BORE OBSTRUCTIONS CAN CAUSE DEATH OR SERIOUS INJURY TO YOU OR OTHERS. In all cases, wear safety glasses and hearing protection designed for firearm use.

This firearm uses 5.56mm NATO or .223 ammunition. Never mix ammunition. Ammunition that is not designed for this firearm may rupture, causing serious injury or death to you or others.

Always check your ammunition to be sure that it is not dirty, damaged or corroded which may cause it to rupture, causing serious injury or death to you or others and/or damage to this firearm.

8. STATE BY STATE WARNINGS

CALIFORNIA:



WARNING: “Children are attracted to and can operate firearms that can cause severe injuries or death. Prevent child access by always keeping guns locked away and unloaded when not in use. If you keep a loaded firearm where a child obtains and improperly uses it, you may be fined or sent to prison.”

“A los niños los atraen las armas de fuego y las pueden hacer funcionar. Ellos pueden causarse lesiones graves y la muerte. Evite que los niños tengan acceso a las armas de fuego guardándolas siempre con llave y descargadas cuando no las esté utilizando. Si usted tiene un arma de fuego cargada en un lugar en que un niño tiene acceso a ella y la usa indebidamente, le pueden dar una multa o enviarlo a la cárcel.

CONNECTICUT:

“UNLAWFUL STORAGE OF A LOADED FIREARM MAY RESULT IN IMPRISONMENT OR FINE.”

8. STATE BY STATE WARNINGS CONTINUED

FLORIDA:

“IT IS UNLAWFUL, AND PUNISHABLE BY IMPRISONMENT AND FINE, FOR ANY ADULT TO STORE OR LEAVE A FIREARM IN ANY PLACE WITHIN THE REACH OR EASY ACCESS OF A MINOR UNDER 18 YEARS OF AGE OR TO KNOWINGLY SELL OR OTHERWISE TRANSFER OWNERSHIP OR POSSESSION OF A FIREARM TO A MINOR OR A PERSON OF UNSOUND MIND.”

MAINE:

“ENDANGERING THE WELFARE OF A CHILD IS A CRIME. IF YOU LEAVE A FIREARM AND AMMUNITION WITHIN EASY ACCESS OF A CHILD, YOU MAY BE SUBJECT TO FINE, IMPRISONMENT OR BOTH. KEEP FIREARMS AND AMMUNITION SEPARATE. KEEP FIREARMS AND AMMUNITION LOCKED UP. USE TRIGGER LOCKS.”

MARYLAND:

“WARNING: Children can operate firearms which may cause death or serious injury. It is a crime to store or leave a loaded firearm in any location where an individual knew or should have known that an unsupervised minor would gain access to the firearm. Store your firearm responsibly!”

MASSACHUSETTS:

“WARNING FROM THE MASSACHUSETTS ATTORNEY GENERAL: This handgun is not equipped with a device that fully blocks use by unauthorized users. More than 200,000 firearms like this one are stolen from their owners every year in the United States. In addition, there are more than a thousand suicides each year by younger children and teenagers who get access to firearms. Hundreds more die from accidental discharge. It is likely that many more children sustain serious wounds, or inflict such wounds accidentally on others. In order to limit the chance of such misuse, it is imperative that you keep this weapon locked in a secure place and take other steps necessary to limit the possibility of theft or accident. Failure to take reasonable preventive steps may result in innocent lives being lost, and in some circumstances may result in your liability for these deaths.”

MASSACHUSETTS Continued:

“IT IS UNLAWFUL TO STORE OR KEEP A FIREARM, RIFLE, SHOTGUN OR MACHINE GUN IN ANY PLACE UNLESS THAT WEAPON IS EQUIPPED WITH A TAMPER-RESISTANT SAFETY DEVICE OR IS STORED OR KEPT IN A SECURELY LOCKED CONTAINER.”

NEW JERSEY:

“IT IS A CRIMINAL OFFENSE TO LEAVE A LOADED FIREARM WITHIN EASY ACCESS OF A MINOR.”

NEW YORK CITY:

“THE USE OF A LOCKING DEVICE OR SAFETY LOCK IS ONLY ONE ASPECT OF RESPONSIBLE FIREARM STORAGE. FOR INCREASED SAFETY, FIREARMS SHOULD BE STORED UNLOADED AND LOCKED IN A LOCATION THAT IS BOTH SEPARATE FROM THEIR AMMUNITION AND INACCESSIBLE TO CHILDREN AND UNAUTHORIZED PERSONS.”

NORTH CAROLINA:

“IT IS UNLAWFUL TO STORE OR LEAVE A FIREARM THAT CAN BE DISCHARGED IN A MANNER THAT A REASONABLE PERSON SHOULD KNOW IS ACCESSIBLE TO A MINOR.”

TEXAS:

“IT IS UNLAWFUL TO STORE, TRANSPORT, OR ABANDON AN UNSECURED FIREARM IN A PLACE WHERE CHILDREN ARE LIKELY TO BE AND CAN OBTAIN ACCESS TO THE FIREARM.”

WISCONSIN:

“IF YOU LEAVE A LOADED FIREARM WITHIN THE REACH OR EASY ACCESS OF A CHILD YOU MAY BE FINED OR IMPRISONED OR BOTH IF THE CHILD IMPROPERLY DISCHARGES, POSSESSES, OR EXHIBITS THE FIREARM.”

NOTE: IN REGARDS TO ALL STATE-BY-STATE WARNINGS:

You must also check with the state police or your local licensed retailer for additional information and warnings, which may apply or be required under local laws and regulations.



TROY®

Carbine

All TROY 5.56 Carbine and Rifles

DESCRIPTION AND OPERATION





WARNING:

BEFORE USING A FIREARM, READ AND FOLLOW INSTRUCTIONS

IF THERE IS ANYTHING YOU DO NOT UNDERSTAND, GET HELP FROM
SOMEONE QUALIFIED IN THE SAFE HANDLING OF FIREARMS.

OBSERVE SAFE FIREARM HANDLING PRACTICES AND WEAR SAFETY GLASSES AT ALL TIMES.

9. FUNCTIONAL INSPECTION

-  **WARNING:** ALWAYS WEAR SAFETY GLASSES WHEN INSPECTING THIS FIREARM.
-  **WARNING:** WHEN INSPECTING THIS FIREARM, ALWAYS MAKE SURE THAT IT IS UNLOADED. THIS MEANS THAT THE BOLT IS LOCKED OPEN, THE CHAMBER IS CLEAR, THE BARREL IS CLEAR AND THE MAGAZINE IS EMPTY.
-  **WARNING:** WHEN INSPECTING THIS FIREARM, ALWAYS POINT THE MUZZLE IN A SAFE DIRECTION. DO NOT PUT YOUR HANDS IN FRONT OF THE MUZZLE. DO NOT PUT YOUR FINGERS OR ANY OBJECT ON THE TRIGGER.

10. OPERATING THE SAFETY SELECTOR

-  **WARNING:** ALWAYS BE SURE THAT THE SAFETY IS COMPLETELY “ON” UNLESS YOU ARE ACTUALLY FIRING. NOTE: EVEN IF THE SAFETY IS ON, THIS FIREARM MAY STILL DISCHARGE. YOU MUST ALWAYS TREAT THIS FIREARM AS BEING LOADED. THIS MEANS YOU SHOULD NEVER POINT A FIREARM IN AN UNSAFE DIRECTION.



When operating this firearm you must be aware of the safety selector mechanism, located on the left and right of the lower receiver. The safety feature is set “on” when the safety selector is pointing forward toward the word “SAFE” on the firearm. The safety feature can be engaged whenever the hammer is cocked. When the safety is placed on “SAFE,” it blocks the trigger. Whenever you are loading or unloading the firearm you should always set the safety selector to “SAFE”.

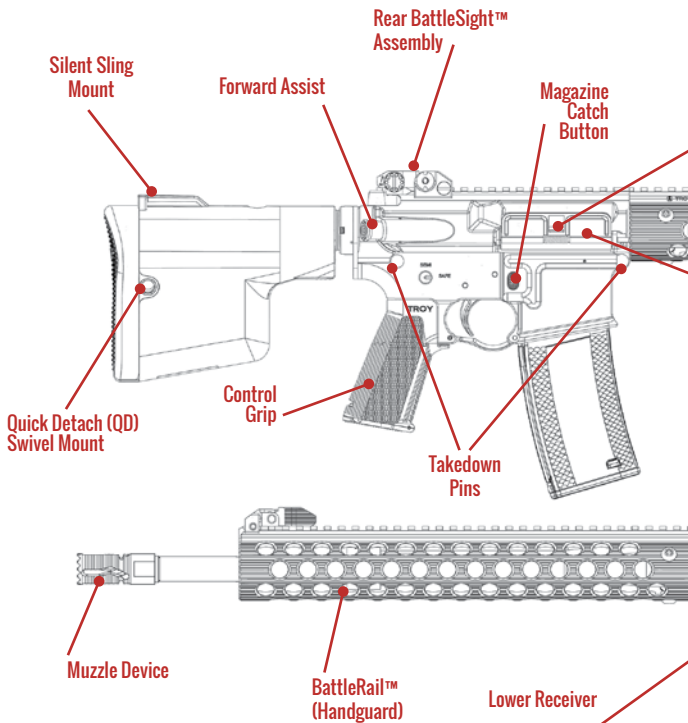

All TROY Rifles, Carabines and SBRs come in many different configurations. Yours may differ in appearance or components from the illustration above. If you have any questions or concerns about your particular firearm please call TROY Customer Service at: **866-788-6412**.

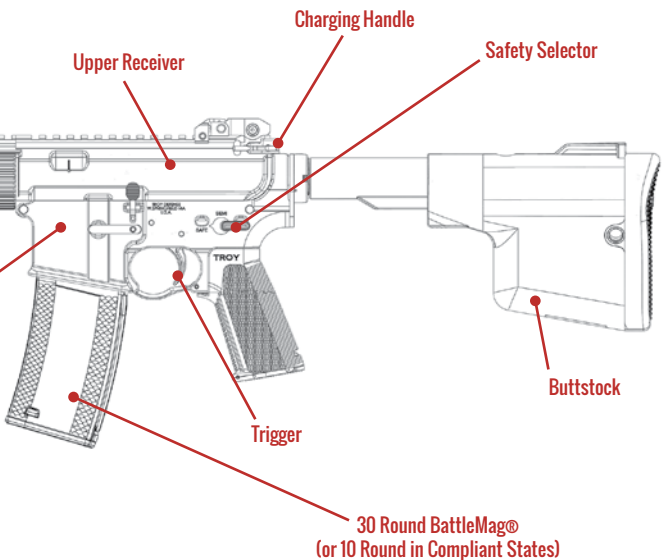
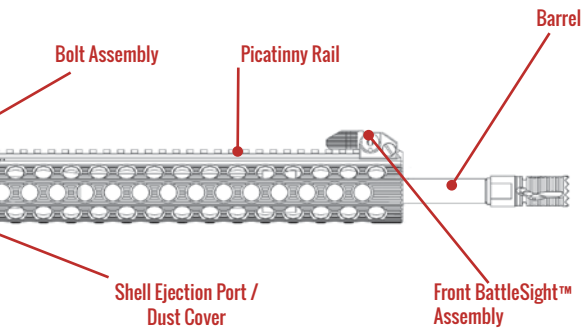

11. OPERATING THE BOLT CATCH

MAKE SURE FIREARM IS POINTED IN A SAFE DIRECTION



- 1** Put safety selector on "SAFE".

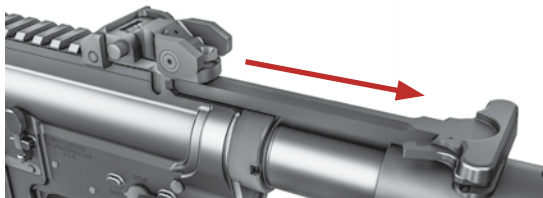

- 2** Pull back the charging handle all the way to the rear.

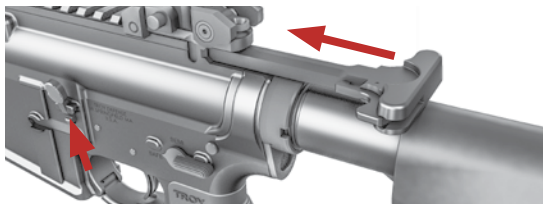

- 3** Depress and hold the lower part of the bolt catch and allow the charging handle to move forward slowly until it stops in the closed position.



- 4 When releasing the bolt carrier keep the safety selector on "SAFE," your finger off the trigger, and depress the top part of the bolt catch to allow the bolt carrier to release and the bolt to close on the chamber.

12. LOADING YOUR FIREARM WITH A MAGAZINE

WARNING: ALWAYS USE THE CORRECT AMMUNITION FOR THIS FIREARM. NEVER USE AMMUNITION THAT HAS BEEN “HANDLOADED”, IS NON-STANDARD, RELOADED, OR HAS NOT BEEN TESTED AND SUBJECTED TO BALLISTIC PRESSURE TESTING. THE USE OF THE WRONG AMMUNITION, INCORRECT CARTRIDGE COMPONENTS, OR BORE OBSTRUCTIONS CAN CAUSE DEATH OR SERIOUS INJURY TO YOU OR OTHERS.

In all cases, wear safety glasses and hearing protection specified for firearm use.

WARNING: NEVER USE MAGAZINES THAT ARE NOT STANDARD, DAMAGED, DISASSEMBLED, ALTERED, MODIFIED OR HAVE BEEN ASSEMBLED IN AN IMPROPER FASHION. Doing so can cause a malfunction to take place.



Always place rounds into the magazine from the top. Place rounds down onto the follower and depress until the feed lip holds the rounds. Continue to load until the desired amount of rounds is placed into the magazine.

When inserting the magazine, place the top part of the magazine into the magwell and slide it all the way up. Always be sure to check that the magazine is fastened securely in place.



To remove the magazine from this firearm, depress the magazine catch button. Pull the magazine out of the magwell. Do not let the magazine fall and hit the ground because that can cause damage to the magazine.



13. SAFE FIRING



WARNING: THIS FIREARM IS ABLE TO FIRE WHEN THE MAGAZINE IS REMOVED. IF THE MAGAZINE IS REMOVED AND A ROUND IS IN THE CHAMBER, THE ROUND WILL BE FIRED WHEN THE TRIGGER IS PULLED. ALWAYS KNOW IF THERE IS A LIVE ROUND IN THE CHAMBER AND ALWAYS POINT YOUR FIREARM IN A SAFE DIRECTION.

ALWAYS MAKE SURE FIREARM IS POINTED IN A SAFE DIRECTION

- 1 Make sure that you fully understand the important aspects of handling this firearm and be sure that you can operate the functions with skill and confidence through practice with an unloaded firearm.

2



Prior to placing a magazine in the magwell, be sure to engage the bolt catch so the carrier is fixed open. Be sure the chamber is clear. Move the safety to the "SAFE" position.



- 3 Insert a magazine, with the desired amount of rounds, into the magazine well. Depress the top part of the bolt catch. The bolt/bolt carrier will move forward into the closed battery position; chambering a live round as it does.

WARNING: AT THIS POINT, THE FIREARM IS COCKED AND LOADED WITH A ROUND IN THE CHAMBER. AT THIS POINT YOU SHOULD MAKE SURE THAT THE SAFETY SELECTOR IS STILL ON “SAFE”, AND KEEP THE FIREARM POINTED IN A SAFE DIRECTION.



- 4** Grip the handguard of the firearm with one hand and grasp the grip with your other hand making sure to rest your index finger on the outside of the trigger guard. Raise the firearm and place the buttstock into your right shoulder.



- 5** Visually locate a safe target. Once you have identified a safe target, aim your firearm at it. At this point, turn the safety selector switch to the “SEMI” position. When the target is properly aligned in your sights, steadily squeeze the trigger until a round is fired.

MAKE SURE OF YOUR BACKSTOP. A BULLET CAN TRAVEL OVER 5 MILES.

⚠ WARNING: WHEN FIRING, KEEP YOUR FACE AND HANDS AWAY FROM THE BOLT CARRIER. THE BOLT CARRIER OPENS AND CLOSES RAPIDLY WHEN FIRING. HOT BRASS AND POWDER GAS CAN EJECT AND BURN YOU. The Firearm should be fired from the right shoulder. Shooting safety glasses and hearing protection should always be used when firing.

⚠ WARNING: MAKE SURE YOU ARE STILL WEARING YOUR EYE AND HEARING PROTECTION.

6 In “**SEMI**” fire mode your firearm will reload immediately after firing. You may continue to fire by releasing the trigger then continuing this cycle of fully pulling back on the trigger and releasing the trigger until the magazine is empty.

7 If you no longer desire to fire the firearm, release the trigger, remove your finger from the trigger guard, and move the safety selector forward to the “**SAFE**” position.



8 When the last round has been fired from the magazine, the bolt catch will engage and the bolt/bolt carrier will be held to the rear in an open position. This allows the firearm to be quickly reloaded or inspected to ensure that the chamber is empty.





WARNING: ALWAYS REMOVE ANY MAGAZINE AND AMMUNITION FROM THIS FIREARM'S CHAMBER WHEN YOU HAVE FINISHED SHOOTING. After shooting the firearm for a sustained period of time, a “cook-off” can take place, when the firearm is at an excessively high temperature, potentially causing ammunition in the firearm to inadvertently discharge. This can occur for an extended period of time even after the weapon firing has ceased.



WARNING: IF THIS FIREARM IS DROPPED OR STRUCK, THE FIREARM MAY DISCHARGE. ALWAYS MAKE SURE THE FIREARMS CHAMBER IS EMPTY UNTIL YOU ARE READY TO SHOOT.

14. UNLOADING

KEEP THE FIREARM POINTED IN A SAFE DIRECTION AND SET THE FIREARM SAFETY SELECTOR TO THE "SAFE" POSITION.



- 1** Depress the magazine catch and remove the magazine.



- 2** Pull back on the charging handle all the way to the rear of the firearm to extract any remaining round from the chamber and to lock the bolt in the open position. When the last round has been fired from the magazine the bolt catch will engage and the bolt/bolt carrier will be held to the rear and remain in an open position.

15. CLEARING MISFIRES

IMPORTANT: IF YOUR FIREARM IS EQUIPPED WITH A TROY PDW STOCK OR TROY TOMAHAWK™ STOCK, YOUR TAKEDOWN PROCESS WILL DIFFER. SEE SECTION 16 ON PAGE 31 FOR FULL INSTRUCTIONS

- 1** In the event your chambered round fails to fire, keep the muzzle pointed in a safe direction push the safety lever forward into the “SAFE” position, and wait for at least 2 minutes.
- 2** Keep your finger off the trigger guard.
- 3** Depress the magazine catch button and remove the magazine.
- 4** Pull the charging handle rearward and eject the misfired round from the chamber. Remove the rear takedown pin by pushing it out to the right. Tilt the upper receiver barrel assembly upward, away from the lower receiver. Hold the weapon by the barrel with your left hand, pull back the charging handle, AND remove the bolt/bolt carrier to the rear. Make sure that the barrel chamber and bore have no obstructions. **NEVER LOOK DOWN THE BARREL FROM THE MUZZLE END.** Only after the chamber has been visually checked and cleared should the weapon be reassembled and reloaded.

 **WARNING: MAKE SURE THERE ARE NO BARREL OBSTRUCTIONS BEFORE FIRING THIS FIREARM. CHECK THE BARREL FOR ANYTHING THAT MAY BE OBSTRUCTING THE BARREL OR THE MUZZLE, INCLUDING, BUT NOT LIMITED TO MUD, SNOW, WATER, OIL AND GREASE AND ANY OTHER OBJECT WHICH MAY HAVE ACCIDENTALLY BEEN PLACED WITHIN THE BARREL. BARREL OBSTRUCTIONS CAN CAUSE DAMAGE TO THE FIREARM AND COULD CAUSE INJURY OR DEATH TO YOU OR OTHERS.**

IF YOU BELIEVE THAT YOUR FIREARM MAY HAVE AN OBSTRUCTION OR HAS BEEN EXPOSED TO HUMID CONDITIONS, VISUALLY CHECK TO SEE THAT THE BARREL CHAMBER AND BORE HAVE NO OBSTRUCTIONS. NEVER LOOK DOWN THE BARREL FROM THE MUZZLE END!



15. CLEARING MISFIRES (CONTINUED)

In the event a bullet becomes lodged inside of the bore, perform the following instructions:

1. Place the Safety selector to the “SAFE” position.
2. Remove the magazine from the firearm.
3. Pull the charging handle rearward and eject the misfired round from the chamber. Remove the rear takedown pin by pushing it out to the right. Tilt the upper receiver barrel assembly upward, away from the lower receiver. Holding the weapon by the barrel with your left hand, pull back the charging handle, removing the bolt/bolt carrier to the rear. Visually check to see that the barrel chamber and bore have no obstructions. **NEVER LOOK DOWN THE BARREL FROM THE MUZZLE END.** Only after the chamber has been visually checked and cleared should the weapon be reassembled and reloaded.
4. You may try to dislodge the bullet from the bore with a cleaning rod that does not have a tip or brush. If this does not work, take the firearm to your local authorized gunsmith. DO NOT try to dislodge the bullet with anything that is not authorized for removal of bore obstructions.

THOROUGHLY CHECK THE BORE ONCE MORE TO BE SURE IT IS CLEAN OF OBSTRUCTIONS AND DEBRIS.

16. DISASSEMBLY

-  **WARNING:** KEEP THE MUZZLE POINTED IN A SAFE DIRECTION.
-  **WARNING:** ALWAYS WEAR FIREARM SPECIFIC SAFETY GLASSES WHENEVER YOU ARE ASSEMBLING OR DISASSEMBLING YOUR FIREARM.
-  **CAUTION:** NEVER DISASSEMBLE THIS FIREARM BEYOND THE INSTRUCTIONS IN THIS MANUAL.

DETERMINE WHICH STOCK YOUR FIREARM IS EQUIPPED WITH AND PROCEED ACCORDINGLY.

A: TROY BATTLEAX, TOMAHAWK SHORT OR PDW STOCK?
CONTINUE TO **STEP 1** OF THIS PAGE.

B: TROY TOMAHAWK STANDARD? SEE INITIAL STEPS ON PAGE 39.

- 1** Make certain that the magazine is removed and that the firearm is not loaded.



- 2** Move the bolt back by pulling the charging handle to the rear.

16. DISASSEMBLY (CONTINUED)



- 3** Use the Forward Assist to close the bolt.
MAKE SURE THE BOLT IS ALL THE WAY FORWARD BEFORE MOVING ON TO STEP 4.



IF YOUR FIREARM IS EQUIPPED WITH A TROY PDW OR TOMAHAWK SHORT STOCK, THEN CONTINUE ON TO SECTION 22.2 ON PAGE 43, OTHERWISE CONTINUE TO STEP 4.



- 4** Push in the rear take down pin on the left side of receiver.



WARNING: SPRING FOR BOLT CARRIER IS UNDER PRESSURE. WEAR EYE PROTECTION AT ALL TIMES.



5 Pivot the upper receiver away from the lower receiver. Remove the charging handle and bolt carrier.

17. ASSEMBLY

WARNING: NEVER DEVIATE FROM THE ASSEMBLY INSTRUCTIONS IN THIS MANUAL. NEVER ALTER OR MODIFY THE PARTS IN THIS FIREARM.

WARNING: WHENEVER YOU ARE ASSEMBLING OR DISASSEMBLING THIS FIREARM OR COMPONENTS, PARTS OR ACCESSORIES TO THIS FIREARM, ALWAYS WEAR SAFETY GLASSES SPECIFIED FOR FIREARMS.



- 1 Be sure to lubricate metal parts of your firearm inside and out with CLP lubricant. You can do so by using high quality gun oil but be sure to remove excess, leaving only a light layer.
- 2 Assemble the firearm by reversing the disassembly procedure.

- 3 When reinstalling the Upper Receiver, you will need to push down on the top of the receiver in order to reinsert the take down pin.



WARNING: KEEP THE MUZZLE POINTED IN A SAFE DIRECTION.



- 4 Pull charging handle to the rear to reengage the buffer system to the carrier.

17.2 FUNCTION CHECK

With the Firearm assembled, perform a function check to ensure proper re-assembly.

1. Operate the charging handle, making certain the bolt assembly moves freely.
2. Operate the “safety” selector, making certain that the “safety” selector moves between on safe and off safe freely.
3. Place the “safety” selector in the “safe” position and properly store the firearm.

18. SIGHTS



WARNING: OBSERVE SAFE FIREARM HANDLING PRACTICES AT ALL TIMES. MAKE SURE THE FIREARM IS UNLOADED AND SAFETY IS ENGAGED BEFORE STARTING INSTALLATION OR DISASSEMBLY.

18.1 ZEROING YOUR BACKUP BATTLESIGHT™ (IF EQUIPPED)

1. Fire a group of four (4) shots and measure average distance from point of aim to point of impact.
2. Adjust front sight for elevation only.
3. Windage adjustments are made with rear sight.
4. Confirm zero with a group of 4 aimed shots and adjust if necessary.

ADJUSTMENTS (Optional Sight Adjustment Tool available at www.TROYind.com). Adjustments can be made with a 5.56mm bullet tip (Fig. 1) or a coin using the coin slot (Fig. 2) To move bullet impact right, turn adjustment wheel to the right/clockwise. To move bullet impact left, turn adjustment wheel to the left/counter clockwise.

Value for one click of adjustment

25 Yards	50 Yards	100 Yards
.16"	.325"	.648"

FIGURE 1



FIGURE 2



18.2 FRONT BATTLESIGHT™ ZEROING AND OPERATION

Depress the button on the left side of the Front Sight. The Front sight will spring forward and lock into position. Depressing the button on the left side of the sight will allow you to manually fold down the front sight back into the recessed area of your Handguard.

ADJUSTMENTS (Optional Sight Adjustment Tool available at www.troyind.com) To move bullet impact up, turn adjustment wheel to the right/clockwise. To move bullet impact down, turn adjustment wheel to the left/counter clockwise.

Value for one click of adjustment

25 Yards	50 Yards	100 Yards
.531"	1.062"	2.125"



19. MOUNTING ACCESSORIES



WARNING: BEFORE MOUNTING A SCOPE, SIGHT OR OTHER ACCESSORIES ON YOUR FIREARM, PLACE THE “SAFETY” SELECTOR IN THE SAFE POSITION. REMOVE THE MAGAZINE, LOCK OPEN THE BOLT AS EXPLAINED IN SECTION 14. AND MAKE CERTAIN THE CHAMBER IS COMPLETELY UNLOADED . KEEP THE MUZZLE POINTED IN A SAFE DIRECTION. FAILURE TO FOLLOW THESE WARNINGS COULD RESULT IN SERIOUS INJURY OR DEATH.

20. OPERATING THE BATTLEAX STOCK

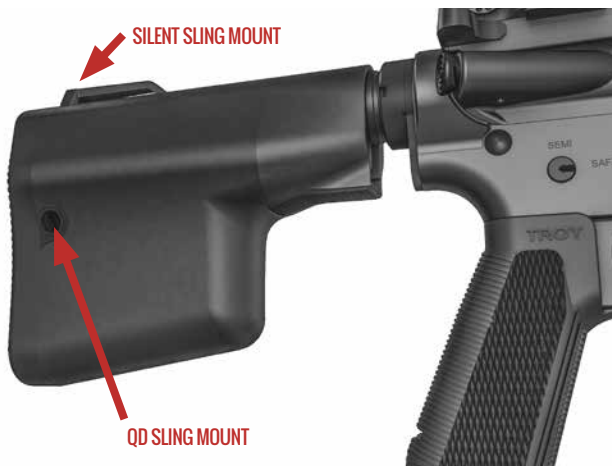

COLLAPSIBLE BUTTSTOCK INSTALLATION ONLY FOR STATES WHERE LEGALLY PERMITTED

The BattleAx™ stock is operated from underneath via the **Stock Release Button**. The Stock has multiple positions along the length of the buffer tube.

Push on the stock release button with your thumb. The lock will be released and the stock will slide freely.

To access the storage compartment, depress the storage latch at the end of the buttstock.

BATTLEAX STOCK EXTENDED

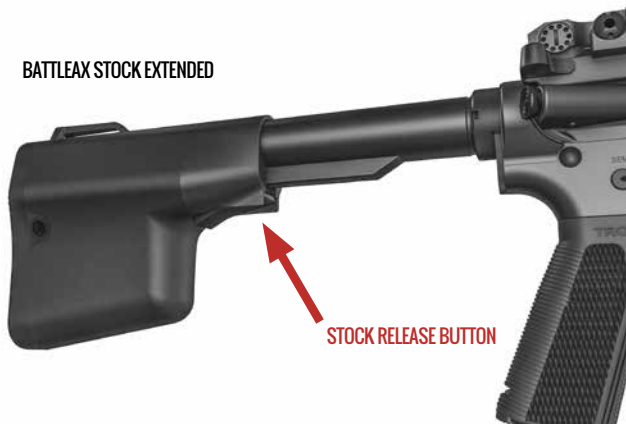

STOCK RELEASE BUTTON

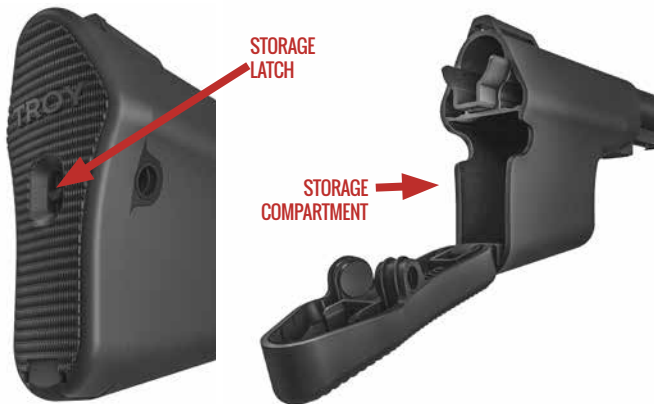

**STORAGE
LATCH**

**STORAGE
COMPARTMENT**

21. OPERATING THE TOMAHAWK™ STANDARD

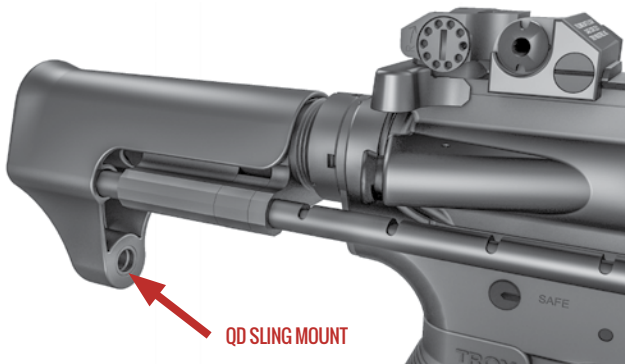

The Tomahawk™ Standard stock is operated from underneath via the **Stock Release Button**. The Stock has 5 positions along the length of the rails.

Push on the Stock release button with your thumb while your hand is on the pistol grip. The lock will be released and the stock will slide freely.

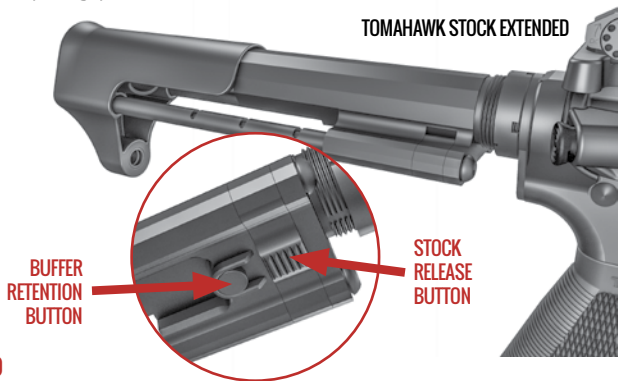

COLLAPSIBLE BUTTSTOCK INSTALLATION ONLY FOR STATES WHERE LEGALLY PERMITTED

DISASSEMBLY PROCEDURE STEP 1.

Prior to takedown you will need to simultaneously hold the bolt back with the charging handle and engage the **BUFFER RETENTION BUTTON** found on the underside of the Tomahawk Stock. Continue depressing the buffer retention button.



REMOVE SPRING AND BUFFER:

Reach in with your thumb and ease the buffer out while releasing the buffer retention button.



**CONTINUE TO STEP 3 OF THE DISASSEMBLY PROCEDURE ON
PAGE 29 OF THIS OPERATOR'S MANUAL.**

22. TROY TOMAHAWK SHORT OR PDW STOCK

COLLAPSIBLE BUTTSTOCK INSTALLATION

ONLY FOR STATES WHERE LEGALLY PERMITTED

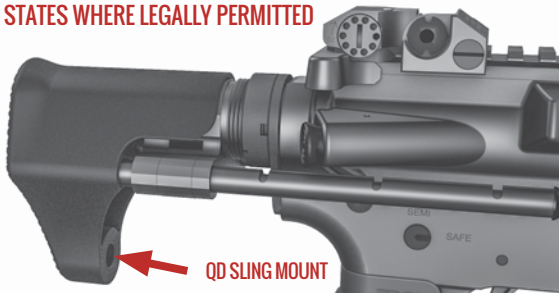

22.1 OPERATION

The Tomahawk™ Short Stock is operated from underneath via the **Stock Release Button**. The Tomahawk Short has 4 positions along the length of the rails and the PDW has 5.

Push on the stock release button with your thumb while your hand is on the pistol grip. The lock will be released and the stock will slide freely.

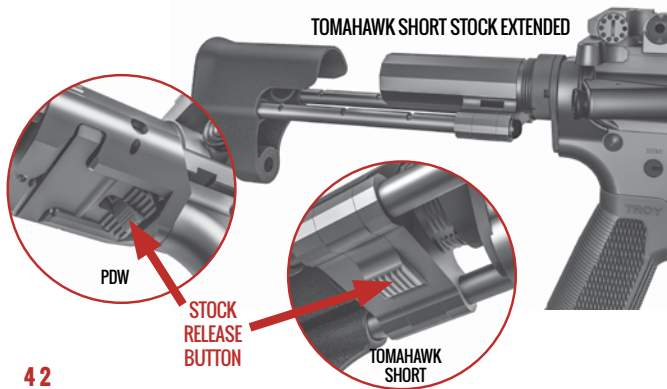



WARNING! SPRING FOR BOLT CARRIER IS UNDER PRESSURE.
WEAR EYE PROTECTION AT ALL TIMES.

22.2 DISASSEMBLY OF TOMAHAWK SHORT OR PDW

To separate the upper receiver from the lower receiver you must release both the REAR and FRONT take down pins. This process differs from the standard take down process for Carbinas not equipped with the TROY PDW Stock or Tomahawk Short.

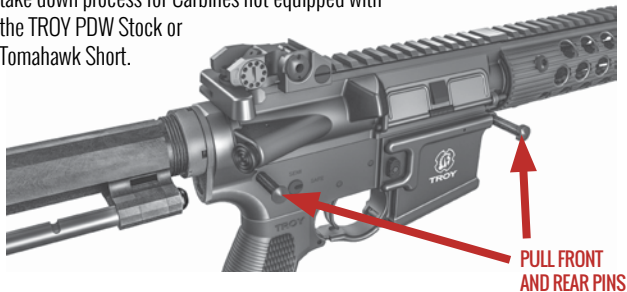

- 1 Push in both the Rear and Front take down pins. Pull both pins from the right side until the detents stop completely.



- 2 Slowly lift and slide upper receiver from lower receiver body. Take care not to bend or crimp the bolt carrier spring.
- 3 Slide out spring from the buffer tube.

ASSEMBLE THE FIREARM BY REVERSING THE DISASSEMBLY PROCEDURE.

23. CLEANING AND UPKEEP



WARNING: BE ABSOLUTELY SURE THAT THIS FIREARM IS COMPLETELY SAFE. THIS MEANS THAT YOUR FIREARM IS UNLOADED AND SAFE BEFORE ATTEMPTING TO CLEAN IT. WHENEVER YOUR FIREARM HAS BEEN FIRED OR EXPOSED TO THE ELEMENTS OR ANY SORTS OF DEBRIS INCLUDING SAND, DIRT, WATER, DUST, HUMIDITY, OR ANY OTHER HARMFUL ELEMENTS OR HARMFUL CONDITIONS, YOU SHOULD CLEAN IT.



WARNING: WEAR SAFETY GLASSES WHEN CLEANING THIS FIREARM.

1. Disassemble your Firearm.
(See **SECTION 14** Disassembly of this Operator's Manual)
2. Use a bore cable or cleaning rod with a solvent wetted patch to remove any excess grease and debris from the bore. Repeat as necessary.
3. Use a bore cable or cleaning rod with dry patches to dry the bore. Run a powder solvent to remove any excess residue from the bore and exterior of the firearm.
4. Run another dry patch through the bore and then push or pull a lightly oiled patch through the bore.
5. Wipe down the rest of the Firearm with a lightly oiled patch.



WARNING: MAKE SURE THERE ARE NO BARREL OBSTRUCTIONS BEFORE FIRING THIS FIREARM. CHECK THE BARREL FOR ANYTHING THAT MAY BE OBSTRUCTING THE BARREL OR THE MUZZLE, INCLUDING, BUT ARE NOT LIMITED TO MUD, SNOW, WATER, OIL AND GREASE AND ANY OTHER OBJECT WHICH MAY HAVE ACCIDENTALLY BEEN PLACED WITHIN THE BARREL. BARREL OBSTRUCTIONS CAN CAUSE DAMAGE TO THE FIREARM AND COULD CAUSE INJURY OR DEATH TO YOU OR OTHERS.

24. TAKING CARE OF THE FIREARM



NOTICE! YOUR FIREARM SHOULD BE INSPECTED EVERY 5000 ROUNDS AND/OR ONCE A YEAR BY A QUALIFIED GUNSMITH BECAUSE DAMAGE, WEAR AND CORROSION ARE NOT ALWAYS VISIBLE FROM THE OUTSIDE. LAW ENFORCEMENT AND MILITARY PERSONNEL SHOULD CONTACT THEIR DEPARTMENTAL ARMORER WHO WILL INSPECT THE FIREARM ON A YEARLY BASIS.



NOTICE! IF THE OPERATION OF YOUR TROY FIREARM SEEMS ABNORMAL, REPORT IT TO YOUR DEALER IMMEDIATELY.

1. Always keep the Firearm in immaculate condition and good working order.
2. Always clean and lubricate the Firearm after use.
3. Regularly inspect the Firearm, its parts and accessories.

26. CONTACT INFORMATION

If you have any questions about this Operator's Manual or other TROY products, contact:

TROY

Phone 866-788-6412

Or visit us online at www.WorldOfTroy.com

IF YOU DO NOT UNDERSTAND THE INSTRUCTIONS FOR OPERATING YOUR TROY FIREARM, IT IS YOUR RESPONSIBILITY TO CONTACT TROY AT 866-788-6412 BEFORE USING THE FIREARM.

This Operator's Manual should always accompany this Firearm and be transferred with it upon any change of ownership.

Please call 866-788-6412 to discuss any product repair requirements.

Shipping Address:

TROY

1575 Corporate Parkway Blvd

Clarksville TN 37040

tech@troyind.com



TROY

866-788-6412

Shipping Address

TROY Industries
1575 Corporate Parkway Blvd
Clarksville TN 37040

PART NO: ZMNL-WRB00