

# OWNER'S MANUAL

## STEYR C-A1 PISTOL



**⚠ WARNING** READ THIS MANUAL  
BEFORE LOADING OR USING YOUR STEYR PISTOL.

**MAINTENANCE NOTES:**

**PERSONAL NOTES:**

 **WARNING!**

Text passages after the word „WARNING!“ contain informations which have to be followed to save the shooter from potential damage.

 **CAUTION!**

Text passages after the word „CAUTION!“ contain informations which have to be followed to avoid potential damage to the weapon.

### **Intended Use**

The STEYR pistol is intended to be used solely for sport shooting purposes according to the respective national regulations. Any other use or any exceeding use is regarded to be a use not intended. The adherence of the instructions regarding safety, operation, maintenance and care given in the users manual are part of the intended use. The user is solely liable for any damages resulting from use not intended. This applies as well for any arbitrary and inappropriate changes to the gun.

 **WARNING!**

**This pistol is designed for firing only high quality, original factory manufactured cartridges. Use of handloaded, reloaded, „remanufactured“ or other nonstandard ammunition may cause serious malfunctions which can pose a safety hazard to the shooter or to others.**

## **Dear Customer**

STEYR PISTOLS have the highest standards in performance, safety and reliability. Advanced safety features, perfect ergonomics and a revolutionary sight are part of the unique STEYR PISTOL design. Highest quality standards are assured by STEYR MANNLICHER's certification according to the Quality standard ISO 9001.

# **INSTRUCTIONS FOR USE**

## **STEYR PISTOLS**

### **PREFACE**

This manual and the warnings contained herein must be read and understood before using your pistol. This manual familiarizes the user with the function and the handling of the pistol and warns against the potential dangers of misuse that may lead to accidents or injuries. This manual should always accompany this firearm and be transferred with it upon change of ownership, or when the firearm is loaned or presented to another person.

**THIS MANUAL IS NOT A SUBSTITUTE FOR A FIREARMS SAFETY COURSE!**

Copyright STEYR MANNLICHER GmbH  
All rights reserved.



**STEYR MANNLICHER GmbH**  
Ramingtal 46  
4442 Kleinraming / Austria  
office@steyr-mannlicher.com  
www.steyr-mannlicher.com

## STANDARDS AND CERTIFICATES

The STEYR MANNLICHER weapons are manufactured in conformity with EN ISO 9001 : 2008, the specification of C.I.P. and certified after proofing in the Austrian Proof House of Vienna.



---

# DNV BUSINESS ASSURANCE

---

## MANAGEMENT SYSTEM CERTIFICATE

---

Certificate No.: 115208-2012-AQ-GER-TGA

*This is to certify that*



### STEYR MANNLICHER

COUNT ON IT  
Steyr Mannlicher GmbH

Ramingtal 46  
4442 Kleinraming - Austria

*has been found to conform to the Management System Standard*

### ISO 9001:2008

*This certificate is valid for the following product or service ranges:*

**Development, manufacture and distribution of  
hunting guns and law enforcement arms**

*Initial Certification date:*  
23.06.2003

---

*This certificate is valid until:*  
26.08.2015

---

*The audit has been performed under the supervision of*

---

**Dieter Leustik**  
*Lead Auditor*



Technische  
Zertifizierungs  
Gesellschaft  
**TGA**  
TGA-ZM-04-02-00

*Place and date:*  
Essen, 27.08.2012

---

*for the Accredited Unit:*  
DNV BUSINESS ASSURANCE (AQ) CERTIFICATION GERMANY



---

**Nils Kim**  
*Management Representative*

Lack of fulfillment of conditions as set out in the Certification Agreement may render this Certificate invalid.  
DNV BUSINESS ASSURANCE (AQ) CERTIFICATION GERMANY, Scheffelweg 14, 41229 Essen, Tel: +49 201 7296 222 Fax: +49 201 7296 300 - www.dnvba.de

## TABLE OF CONTENTS

CHAPTER 1: MAIN FEATURES .....	5
CHAPTER 2: LOADING .....	10
CHAPTER 3: FIRING .....	12
CHAPTER 4: UNLOADING .....	15
CHAPTER 5: DISASSEMBLY .....	18
CHAPTER 6: PREVENTATIVE MAINTENANCE .....	23
CHAPTER 7: REASSEMBLY .....	28
CHAPTER 8: PRODUCT SERVICE .....	29
TECHNICAL SPECIFICATIONS .....	30
PARTS LIST .....	33

# CHAPTER 1: MAIN FEATURES

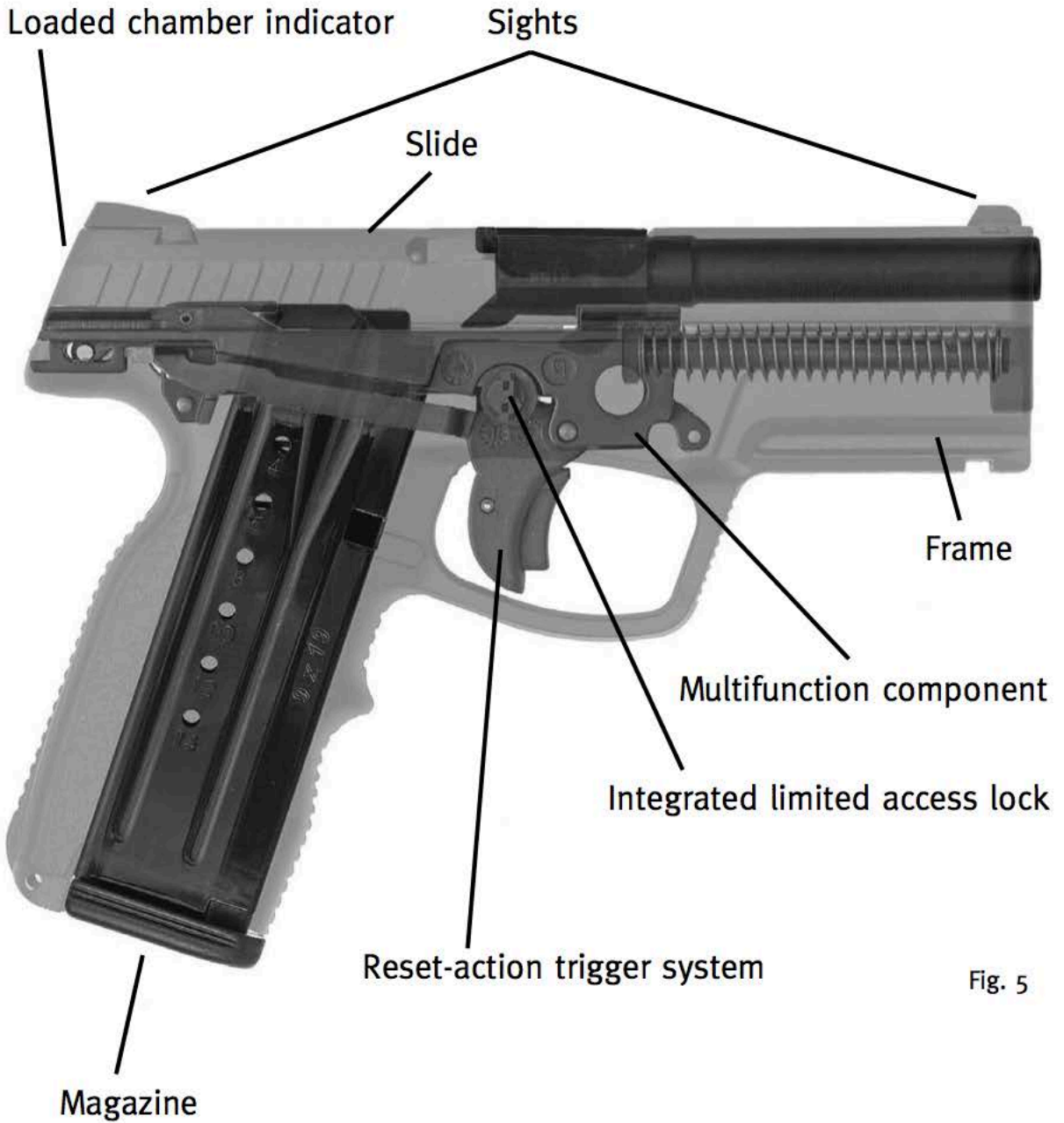

Fig. 5



Your STEYR pistol is a semi-automatic, mechanically locked, recoil-operated pistol. Its main features are as follows.

**FRAME:** The synthetic frame features a grip angle designed for optimal pointability, an ergonomical shape for enhanced comfort in operation and handling, as well as a Picatinny rail for mounting devices on the pistol.

**SLIDE:** The slide has an extremely low height, positively affecting the recoil and aiming characteristics of the pistol.

**BARREL:** The barrel is mechanically locked, 4.01” long and has 6 lands and grooves with a right hand twist.

**MULTIFUNCTION COMPONENT:** The multifunction component is made of steel and inserted into the frame. Its principal features include the trigger and safety devices, as well as the slide catch lever and ejector.

**SIGHTS:** The sights, which consist of a triangular front sight and a rear sight with trapezoid recess, are adjustable in lateral directions. White contrasting surfaces on the front and rear sight serve as additional targeting aids.

**NOTICE** Do not change the original sights on your STEYR pistol or shoot it without them installed because the pin for the loaded chamber indicator passes underneath the rear sight.

**MAGAZINE:** The steel magazine features openings on both sides to determine the number of cartridges left in the magazine (when it is outside of the pistol).

**LOADED CHAMBER INDICATOR:** The loaded chamber indicator may indicate when a cartridge is chambered in the pistol. It visibly protrudes from the rear of the slide and can be felt with your finger.

**WARNING** Although your STEYR pistol has a feature known as a “loaded chamber indicator,” it is a mechanical device, which could fail.

Never solely rely on a loaded chamber indicator or your memory to determine if your STEYR pistol is loaded. Always retract the slide and visually check to make sure there is not a cartridge in the chamber.

**RESET-ACTION TRIGGER SYSTEM:** The reset-action trigger system features a trigger safety, a drop safety and a firing pin catch. These passive safeties function automatically without the need for any action by the user. They are always on and are automatically deactivated by pulling the trigger to its rearmost position.

**⚠ WARNING** Your STEYR pistol does not have a manual safety and will fire if the trigger is pulled when there is a round in the chamber.

**⚠ WARNING** Although STEYR pistols have several internal safeties, designed to prevent an unintentional discharge if the pistol is dropped or hit, the proper and safe function of your STEYR pistol depends on it being used for its intended purpose and not being altered or modified. Like any other mechanical device, if your STEYR pistol is subjected to unusual and extreme forces a part failure can occur. Therefore, safe firearm handling practices and the instructions and safety warnings in this manual must always be followed to minimize the risk of serious personal injury or death to you or others.

**⚠ WARNING** In case any of your STEYR pistol's safeties prove to be ineffective for any reason, the possibility of an unintentional discharge exists. If so, your STEYR pistol should be immediately unloaded and not be used again until it has been examined by STEYR authorized personnel.

**INTEGRATED LIMITED ACCESS LOCK WITH KEY:**



Fig. 6

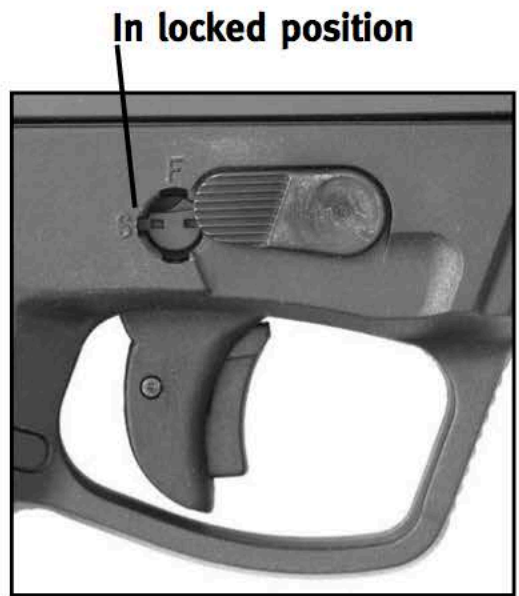
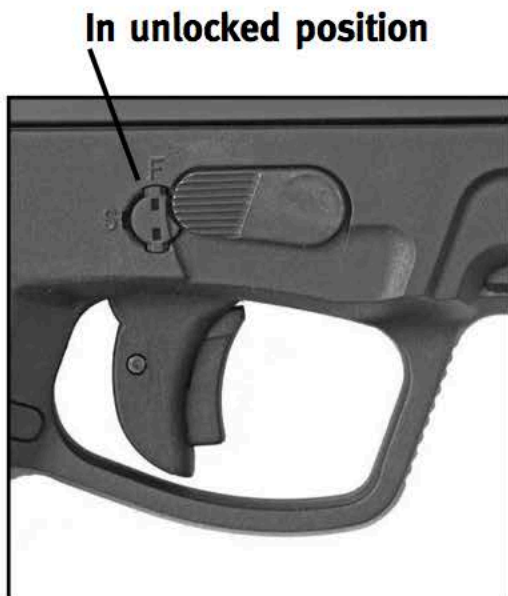

The integrated limited access lock is manually operated by using a separate key. When locked, it locks the trigger and prevents the disassembly of the pistol. The integrated limited access lock can only be locked when the pistol is cocked (trigger in the forward position).

To lock the integrated limited access lock, insert the key into the lock and press down while turning the key towards the letter “S” (Safe) on the frame. This will block the trigger system and prevent disassembly of the pistol. To unlock the integrated limited access lock, insert the key into the lock and press down while turning the key towards the letter “F” (Fire) on the frame.

**⚠ WARNING** Never leave your STEYR pistol where it could be accessed by a child or other unauthorized person.

## **STANDARD EQUIPMENT**

- 1 Pistol
- 2 Magazines
- 2 Keys for the integrated limited access lock
- 1 Owner’s Manual
- 1 Firearms Safety Awareness Form
- 1 Product Service Reply Card
- 1 Pistol Box
- 2 Padlocks with Keys

## CHAPTER 2: LOADING

**⚠ WARNING** To minimize the risk of a negligent discharge, only load live ammunition into your STEYR pistol when you are ready to fire it.

**⚠ WARNING** Only use high quality commercially manufactured ammunition in the same caliber as your STEYR pistol. Reloaded or handloaded ammunition may not meet applicable SAAMI standards and could be unsafe.

**⚠ WARNING** Your STEYR pistol does not have a manual safety and will fire if the trigger is pulled when there is a round in the chamber.

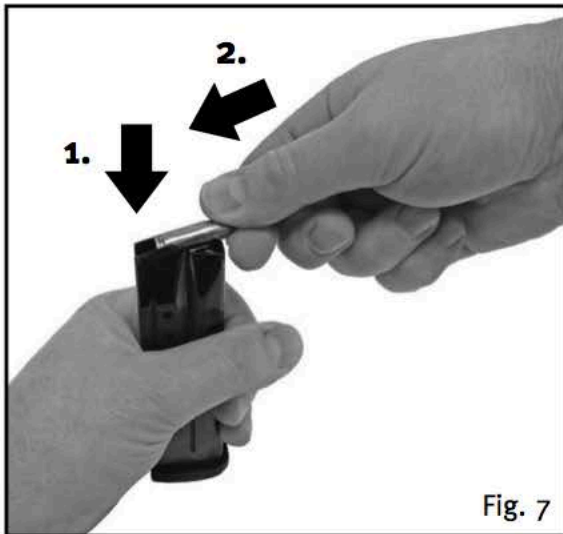

To load the magazine, press each cartridge into the magazine from the front - with the cartridge bottom first - against the force of the magazine spring.

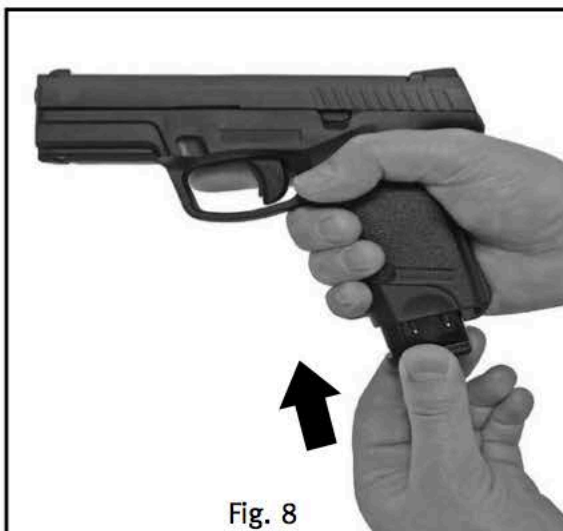

Insert the magazine into the magazine well until the magazine release lock catches.

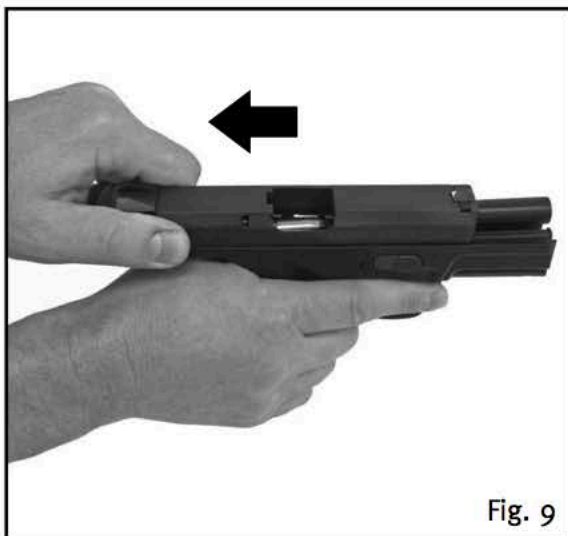

If the slide is in the forward position, hold your STEYR pistol with your firing hand and, while keeping your finger off of the trigger and outside of the trigger guard, pull the slide fully back with the other hand and release it, allowing it to return to the fully forward position.

OR

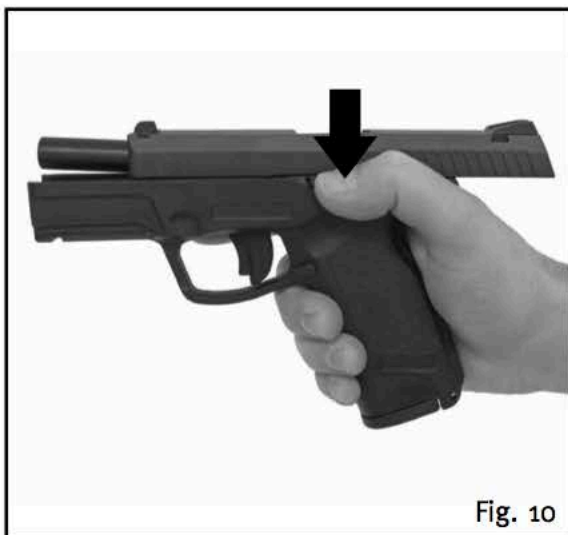

If the slide is locked in the rearward position, either press the slide catch lever down to release the slide and return it to the fully forward position or pull the slide fully back and release it, allowing it to return to the fully forward position.

The pistol is now loaded and ready to be fired by pulling the trigger.

## CHAPTER 3: FIRING

**⚠ WARNING** Before firing your STEYR pistol, run a clean patch through the barrel, from the chamber end, using a cleaning rod. Repeat this procedure until the patch comes out of the barrel with no gun oil or cleaner-lubricant-preservative on it.

**⚠ WARNING** Always be sure that the barrel of your STEYR pistol is clear of obstructions before firing it. Remove any obstructions before firing your STEYR pistol so that it will function safely and correctly. Any obstruction in the barrel could prevent the pistol from firing properly and result in death or serious personal injury and damage to the pistol.

**⚠ WARNING** In case of a failure to fire, continue to hold your STEYR pistol pointed toward the target for at least 30 seconds. If a hangfire (slow ignition) has occurred, the cartridge should fire within approximately 30 seconds. If the cartridge has not fired, remove the magazine, eject the cartridge from the chamber and examine its primer. If the firing pin indentation is light, off-center, or non-existent, have your STEYR pistol examined by STEYR authorized personnel. If the firing pin indentation on the primer appears normal (compared to similar previously fired cartridges) the cartridge may be defective. Separate the cartridge from other live ammunition and empty cases, reload your STEYR pistol and resume firing. NOTE: Dispose of misfired cartridges in accordance with the ammunition manufacturer's instructions.

**⚠ WARNING** Never use your STEYR pistol if it fails to function properly, and never force the slide closed on a jammed cartridge because it could cause the cartridge to explode.

**⚠ WARNING** Never pull the trigger if the slide does not fully close to prevent a possible out of battery firing. If this happens, unload the pistol as described in Chapter 4, examine the round that was in the chamber and check the chamber to ensure that there are no obstructions or debris in it.

**⚠ WARNING** Always wear safety glasses when firing your STEYR pistol to protect your eyes.

**⚠ WARNING** Always wear ear protection when firing your STEYR pistol to protect your hearing.

**⚠ WARNING** Always be sure that your backstop is adequate to stop and contain bullets before firing so that you do not hit anything outside of the shooting range area. A bullet could travel through or past your target as far as 2 miles (approximately 3km). If in doubt, do not shoot.

**⚠ WARNING** Never shoot at a hard surface, such as a rock, or a liquid surface, such as water, because a bullet may ricochet and travel in any direction, striking you or someone else.

**⚠ WARNING** Your STEYR pistol does not have a manual safety and will fire if the trigger is pulled when there is a round in the chamber.

**⚠ CAUTION** When ready to fire be sure that the area behind the slide is clear (check your thumb) and do not hold the pistol near your body, because the slide will move forcefully rearward when the pistol is fired.

**⚠ CAUTION** Always keep yourself and others clear of the ejection port because spent cartridges are hot and are ejected with enough force to cause injury. Never touch the slide or barrel immediately after firing because they may be hot and could cause burns.

**⚠ CAUTION** Never place your fingers in the ejection port because they could be injured by the movement of the slide.

**⚠ CAUTION** Never fire your STEYR pistol near an animal unless it is trained to accept that noise. An animal's startled reaction could injure it, or cause an accident.

**NOTICE** Always put a responsible and competent person in charge



to maintain safety, discipline and control when a group is firing at a range, to reduce the likelihood of a negligent discharge.

**NOTICE** Always carry your STEYR pistol unloaded with the slide locked open in the rearward position while on a range until preparing to fire. Always keep the pistol pointed towards the backstop when loading, firing and unloading it.

When the pistol is loaded with a cartridge in the chamber, the firing pin is partially cocked, the trigger is in the forward position, the Reset Action Safety System with trigger and drop safeties are activated, and the loaded chamber indicator is visible as it protrudes from the rear of the slide and can be felt with the finger.



To fire the pistol, pull the trigger to its rearmost position, using your trigger finger. This will automatically deactivate the trigger and drop safeties.



After firing the last cartridge the slide will remain locked open in the rearward position.

## CHAPTER 4: UNLOADING

**⚠ WARNING** Although your STEYR pistol has a feature known as a “loaded chamber indicator,” it is a mechanical device, which could fail. Never solely rely on a loaded chamber indicator or your memory to know if your STEYR pistol is loaded. Always retract the slide and visually check to make sure there is not a cartridge in the chamber.

**⚠ WARNING** It is possible that a cartridge may be in the chamber when a loaded magazine is being removed from or inserted into your STEYR pistol. A cartridge in the chamber will discharge when the trigger is pulled, whether or not a magazine is in your STEYR pistol. Therefore, never leave your STEYR pistol unattended, even when the magazine is removed. You must always verify that the chamber is empty before field stripping your STEYR pistol for cleaning or any other reason.

To unload your STEYR pistol, follow the instructions below.

**⚠ WARNING** To ensure that your STEYR pistol is unloaded, you MUST follow these steps in these order to ensure that there is no cartridge in the chamber when you have finished unloading.

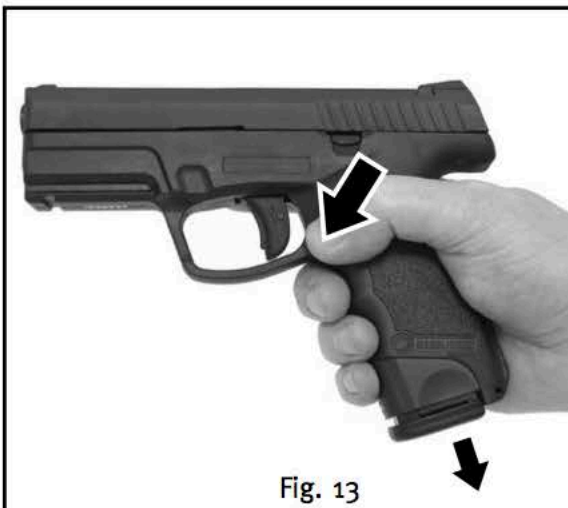

1. Remove the magazine by pressing the magazine release.

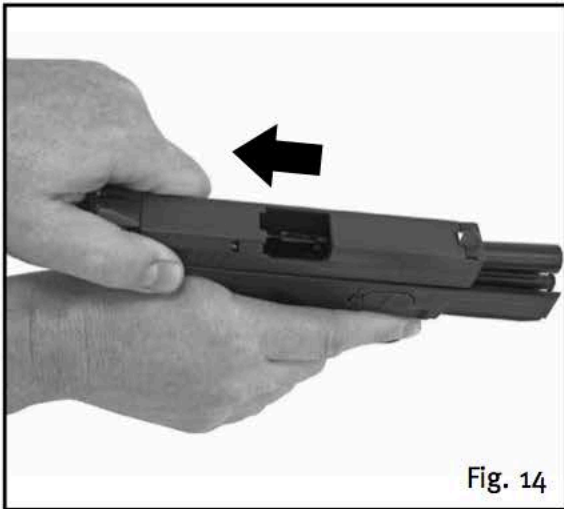

2. Retract the slide to eject any cartridge that may be in the chamber.

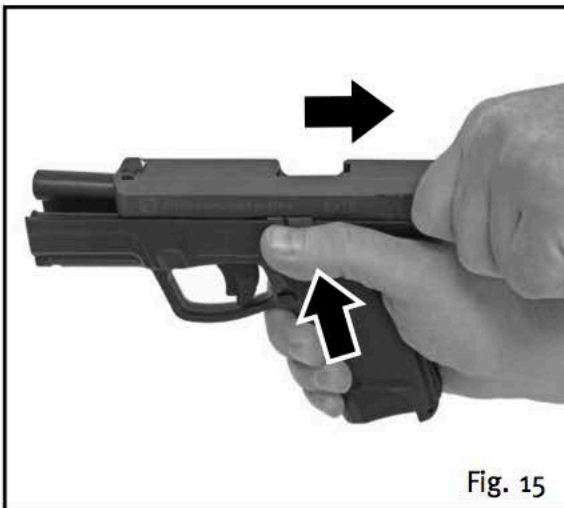

3. Lock the slide in the rearward (open) position.

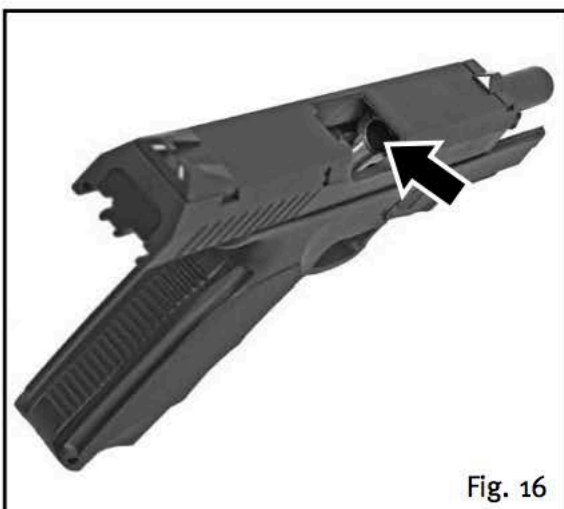

4. Visually and manually check to make sure that no cartridge remains in the chamber.

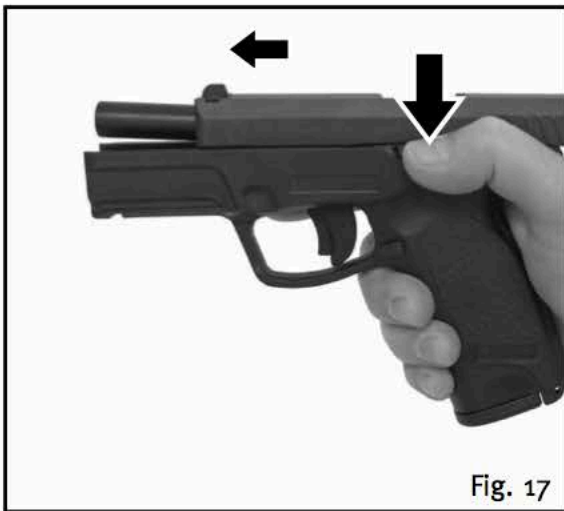

5. Release the slide to return it to the forward (closed) position.

Fig. 17

Your STEYR pistol may also be unloaded when the integrated limited access safety lock is engaged.

## CHAPTER 5: DISASSEMBLY

**⚠ WARNING** Although your STEYR pistol has a feature known as a “loaded chamber indicator,” it is a mechanical device, which could fail. Never solely rely on a loaded chamber indicator or your memory to know if your STEYR pistol is loaded. Always retract the slide and visually check to make sure there is not a cartridge in the chamber.

**⚠ WARNING** It is possible that a cartridge may be in the chamber when a loaded magazine is being removed from or inserted into your STEYR pistol. A cartridge in the chamber will discharge when the trigger is pulled, whether or not a magazine is in your STEYR pistol. Therefore, never leave your STEYR pistol unattended, even when the magazine is removed. You must always verify that the chamber is empty before field stripping your STEYR pistol for cleaning or any other reason.

**⚠ WARNING** Never alter or modify your STEYR pistol because this could cause it to malfunction and create a dangerous condition.

**⚠ WARNING** Always wear safety glasses when disassembling your STEYR pistol to protect your eyes from springs.

To disassemble (field strip) your STEYR pistol for cleaning, follow the instructions below.

**⚠ WARNING** To ensure that your STEYR pistol is unloaded, you MUST follow these steps in these order to ensure that there is no cartridge in the chamber when you have finished unloading.

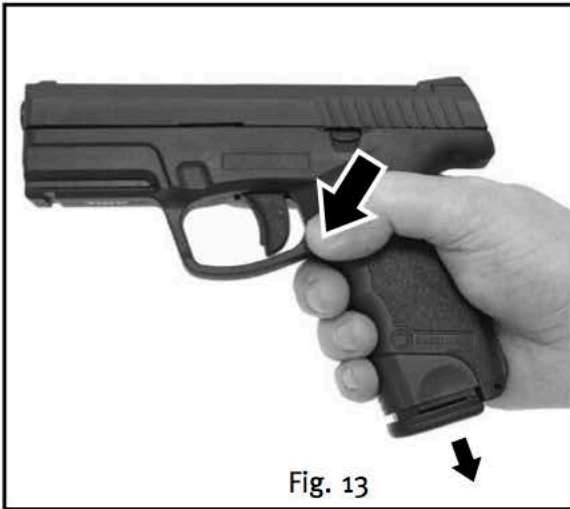

1. Remove the magazine by pressing the magazine release.

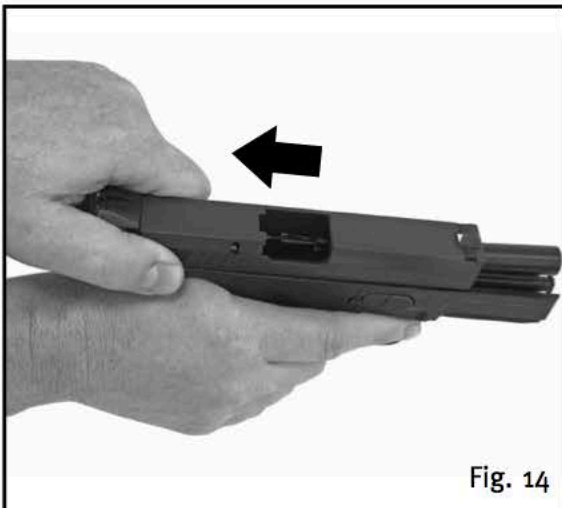

2. Retract the slide to eject any cartridge that may be in the chamber.

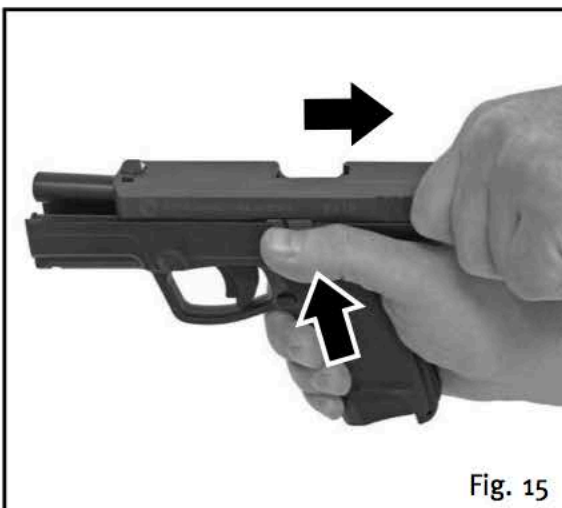

3. Lock the slide in the rearward (open) position.

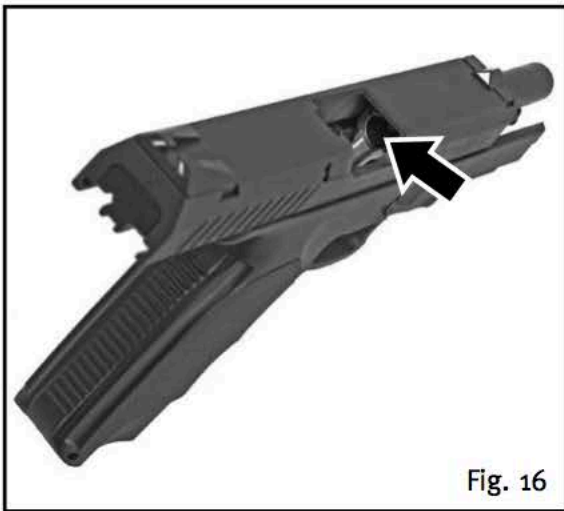

4. Visually and manually check to make sure that no cartridge remains in the chamber.

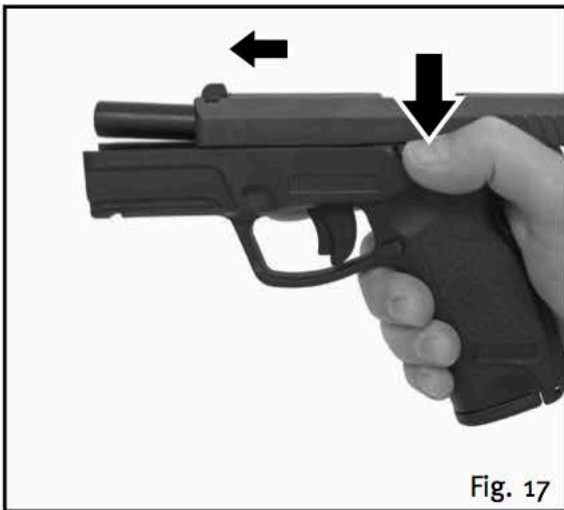

5. Release the slide to return it to the forward (closed) position.



6. With the muzzle of your STEYR pistol pointed in a safe direction, pull the trigger.

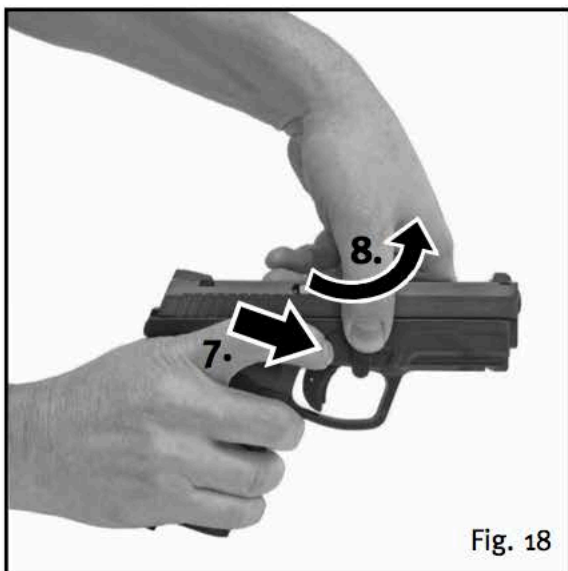

7. Press the integrated limited access lock in with the index finger of your firing hand and hold it pressed in.
8. Swing the disassembly lever down with the thumb of your non-firing hand.

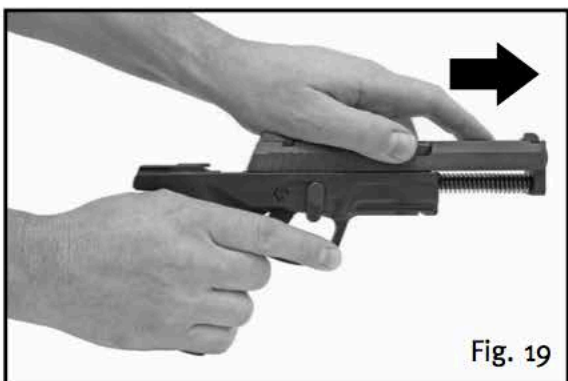

9. Pull the slide off of the grip frame towards the front.

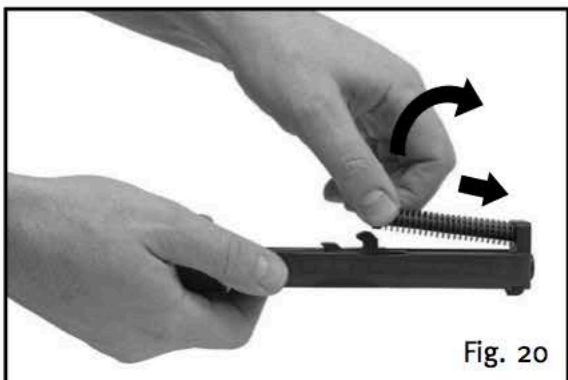

10. Press the recoil spring toward the front of the slide while pulling it up to remove it from the slide.



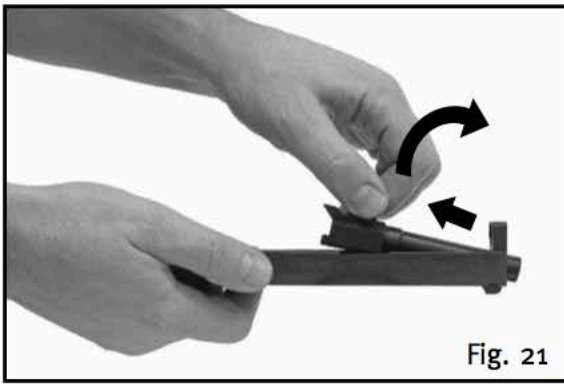

11. Holding the barrel by the bolt lock, lift and remove it from the slide by pulling it up and back.

**⚠ WARNING** Never further disassemble your STEYR pistol. Any further disassembly must be performed by STEYR authorized personnel.

## CHAPTER 6: PREVENTATIVE MAINTENANCE

**⚠ WARNING** Always be sure that the barrel of your STEYR pistol is clear of obstructions before firing it. Remove any obstructions before firing your STEYR pistol so that it will function safely and correctly. Any obstruction in the barrel could prevent the pistol from firing properly and result in death or serious personal injury and damage to the pistol.

**⚠ WARNING** It is possible that a cartridge may be in the chamber when a loaded magazine is being removed from or inserted into your STEYR pistol. A cartridge in the chamber will discharge when the trigger is pulled, whether or not a magazine is in your STEYR pistol. Therefore, never leave your STEYR pistol unattended, even when the magazine is removed. You must always verify that the chamber is empty before field stripping your STEYR pistol for cleaning or any other reason.

**⚠ WARNING** Always wear safety glasses when cleaning your STEYR pistol to protect your eyes from cleaning materials.

**⚠ WARNING** Always make sure that no ammunition is located in the area where you clean your STEYR pistol. Cleaning solvents can affect the primer and powder in ammunition and cause it to malfunction. This could result in a bullet being pushed into the barrel of your STEYR pistol and getting stuck. Firing another round with a bullet stuck in the barrel could cause the barrel to burst and result in death or serious personal injury, in addition to damaging the pistol.

## Main parts for cleaning.



Fig. 22

Clean and lubricate the main parts of your STEYR pistol after you fire it or whenever it becomes exposed to sand, dust or water (including humidity or condensation). Proper maintenance is important to ensure that your STEYR pistol functions correctly. To clean your STEYR pistol, first disassemble it pursuant to the instructions in Chapter 5. Always use cleaning patches and brushes of the proper size for the caliber of your STEYR pistol.

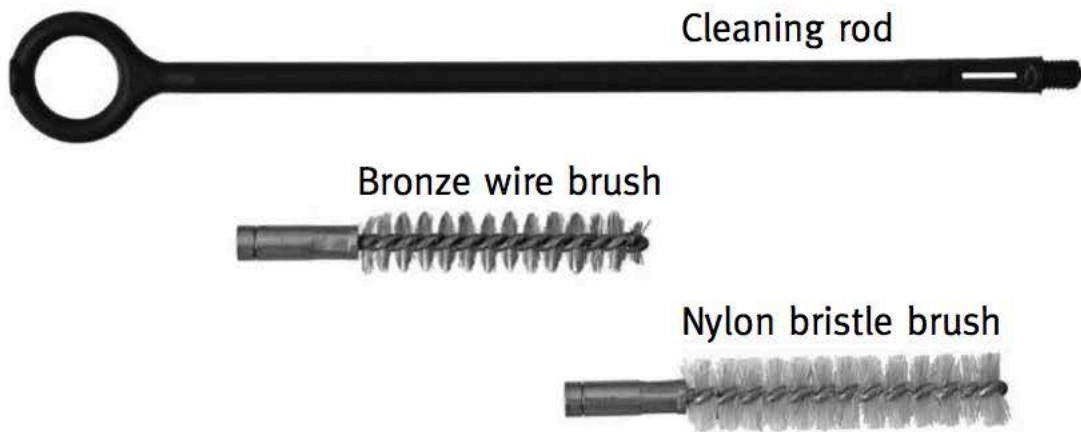

(STEYR cleaning kit optional)

Fig. 23

After you have disassembled your STEYR pistol, clean the inside of the barrel as follows:

1. Wet a cleaning patch with a gun cleaning solvent or a cleaner-lubricant-preservative and run it through the barrel, from the chamber end, several times using a cleaning rod.
2. Wet a bronze wire brush and run it back and forth in the barrel, from the chamber end, using a cleaning rod to remove any fouling and burned powder.
3. Wet another cleaning patch with a gun cleaning solvent or a cleaner-lubricant-preservative and run it through the barrel once, from the chamber end, with the cleaning rod and examine it. If it is not clean, repeat steps two and three until the patch remains clean after being run through the barrel.

4. Run a clean patch through the barrel, from the chamber end, using the cleaning rod.
5. Lightly wet a clean patch with gun oil or a cleaner-lubricant-preservative and run it through the barrel from the chamber end.
6. Before firing your STEYR pistol, run a clean patch through the barrel, from the chamber end, using the cleaning rod. Repeat this procedure until the patch comes out of the barrel with no gun oil or cleaner-lubricant-preservative on it.

**NOTICE** If you will be storing your STEYR pistol, do not perform step 6 until you are ready to fire it.

Clean the slide, rails, outside of the barrel, and slide catch as follows (refer to illustrations on this page):

1. Wet a nylon bristle brush with a gun cleaning solvent or a cleaner-lubricant-preservative and thoroughly brush these areas to remove any dirt or residue.
2. Wipe the areas dry with a clean patch and examine it. If it is not clean, repeat steps one and two until the patch remains clean.

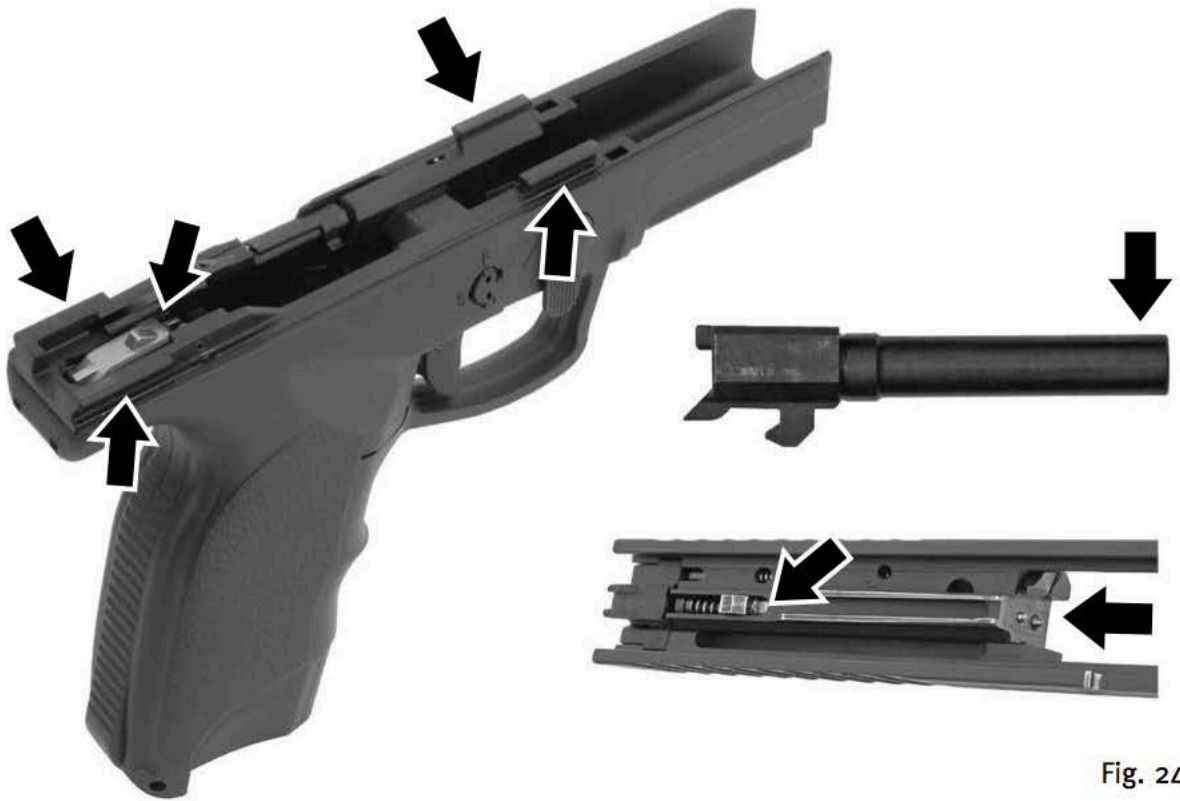

Fig. 24

### Oiling points

3. Apply a thin film of gun oil or cleaner-lubricant-preservative to the firing pin, bolt lock guides, and the outside of the front end of the barrel as shown in the above illustration.

**CAUTION** Do not over lubricate your STEYR pistol because too much lubricant can collect unburned powder and other debris and prevent your STEYR pistol from functioning properly.

Reassemble your STEYR pistol as described in Chapter 7.

## CHAPTER 7: REASSEMBLY

**⚠ WARNING** Always wear safety glasses when reassembling your STEYR pistol to protect your eyes from springs.

To reassemble your STEYR pistol after cleaning it, follow the instructions below.

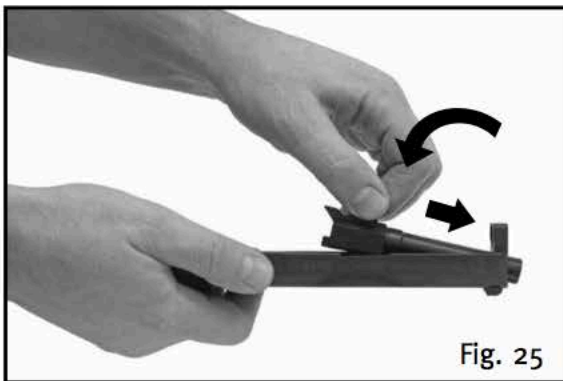

1. Holding the barrel by the bolt lock, insert it into the slide by pushing it down and in.



2. Insert the recoil spring into the slide by pressing it down and in.

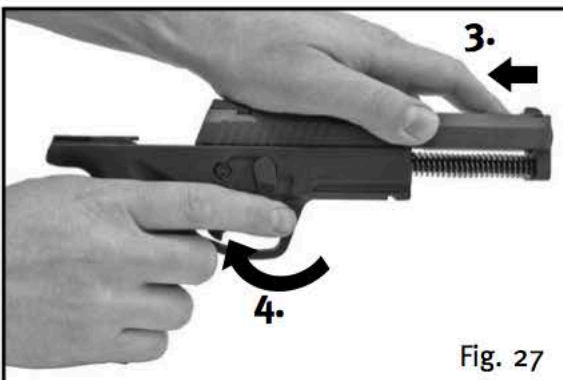

3. Push the slide onto the grip frame towards the back.
4. Swing the disassembly lever back up.

## **CHAPTER 8: PRODUCT SERVICE**

Because of the complexity of the terms of the Magnuson-Moss Warranty Act, STEYR ARMS, Inc. has chosen not to offer an express warranty. STEYR ARMS, Inc. still remains committed to its customers and stands behind the quality of its products. If your STEYR pistol requires service, write to STEYR ARMS, Inc. at 2530 Morgan Road Bessemer, AL 35022 or call (205) 417-8644 for instructions on how to return your pistol. Do not return your STEYR pistol for service without prior authorization.

The implied warranties of merchantability and fitness for a particular purpose are expressly disclaimed. STEYR ARMS, Inc. will not be responsible for any damage or injury caused by disassembly of the pistol beyond the field stripping described in Chapter 5 of this Owner's Manual, alterations or modifications to the pistol, or the use of reloaded or hand loaded ammunition, or ammunition of a different caliber than your STEYR pistol.



## TECHNICAL DATA C-A1

	<b>C 9-A1</b>	<b>C 40-A1</b>
<b>Caliber</b>	9 x 19 mm	.40 S&W
<b>Magazine capacity</b>	15	12
<b>Weight</b> (with empty magazine)	27.02 oz / 766 g	27.52 oz / 780 g
<b>Weight of empty magazine</b>	3.00 oz / 85 g	3.00 oz / 85 g
<b>Length/slide</b>	6.7" / 170 mm	6.9" / 175 mm
<b>Height</b>	5.2" / 132 mm	5.2" / 132 mm
<b>Width</b>	1.18" / 30 mm	1.18" / 30 mm
<b>Length of sight</b>	5.84" / 148,5 mm	6" / 152 mm
<b>Barrel length</b>	3.62" / 92 mm	3.78" / 96 mm
<b>Barrel profile</b>	6 lands and grooves, right handed	
<b>Trigger system</b>	Reset action system (special double action system)	
<b>Trigger travel (constant)</b>	0.15" / 4 mm	
<b>Trigger pull</b>	5.51 lb / ~ 2,5 kg	
<b>Reset action safeties</b>	Trigger safety, indirect firing pin safety and drop safety, loaded chamber indicators and limiting trigger access lock	
<b>Manual safety</b>	optional	optional
<b>Integrated limited access lock with key</b>	1	1
<b>Loaded chamber indicator</b>	2	2

# PARTS LIST

ITEM	DENOMINATION	QUANTITY
1	BARREL	1 pcs.
2	FRAME	1 pcs.
ASSY A	MAGAZINE RELEASE ASSEMBLY	1 pcs.
3	* MAGAZINE RELEASE	1 pcs.
4	* MAGAZINE RELEASE REST	1 pcs.
5	* MAGAZINE RELEASE SPRING	1 pcs.
ASSY B	MULTIFUNCTION ELEMENT WITH EJECTOR	1 pcs.
6	* MULTIFUNCTION ELEMENT	1 pcs.
8	* EJECTOR	1 pcs.
9	* EJECTOR/DROP SAFETY LEVER	2 pcs.
7	DISASSEMBLY LEVER	1 pcs.
10	CATCH	1 pcs.
11	LEVER	1 pcs.
12	CATCH SPRING	1 pcs.
13	LEVER SPRING	1 pcs.
14	CATCH PIN	1 pcs.
15	LEVER PIN	1 pcs.
ASSY C	TRIGGER BAR ASSEMBLY	1 pcs.
16	* TRIGGER BAR	1 pcs.
17	* TRIGGER	1 pcs.
18	* TRIGGER SAFETY	1 pcs.
19	* TRIGGER BAR SPRING	1 pcs.
20	* TRIGGER SPRING	1 pcs.
21	* TRIGGER BAR PIN	1 pcs.
22	* TRIGGER PIN	1 pcs.



Edition US 01

**STEYR ARMS, Inc.**

2530 Morgan Road  
Bessemer, AL 35022

Tel. (205) 417-8644

Fax.(205) 417-8647

[www.steyrarms.com](http://www.steyrarms.com)



STEYR MANNLICHER GmbH  
Ramingtal 46, 4442 Kleinraming, Austria  
[www.steyr-mannlicher.com](http://www.steyr-mannlicher.com)