



**SEMI-AUTOMATIC SHOTGUN
INSTRUCTION MANUAL**

**READ THE INSTRUCTIONS AND
WARNINGS IN THIS MANUAL CAREFULLY
BEFORE USING THIS FIREARM**

GUN SAFETY RULES

Observe these rules of safe gun handling.

1. Always keep the muzzle pointed in a safe direction. Watch the muzzle at all times: never point a gun, accidentally or intentionally, at any person or anything you do not intend to shoot. Identify the target before shooting; do not shoot at sounds.

2. Always treat any gun as if it is loaded - it may be!

3. Keep your finger off the trigger while operating the action and at all other times until you are ready to shoot.

4. Keep the safety "on" or in the "safe" position at all times until you are ready to fire the gun. Move to shoot. Up to the previous line after the word intend.

to shoot.

Do not rely on your gun's safety, the safety on any gun is a mechanical device and is not intended as a substitute for common sense or safe gun handling.

5. Learn how your gun functions and handles. If you do not thoroughly understand the proper use and care of your gun, seek the advice of someone who is knowledgeable.

6. Do not alter or modify any parts of a firearm.

7. Store guns unloaded, separate from any ammunition, and where children cannot get to them.

8. Be sure the barrel is clear of any obstructions before loading. Make it a habit to check the barrel every time before loading.

9. Be sure you have and use the proper ammunition. A 20 gauge shell will enter a 12 gauge chamber far enough so that a 12 gauge shell can be loaded behind it. Also, a 3 inch shell may fit into a 2 3/4 inch chamber, but the crimp at the mouth of the shell will unfold into the forcing cone. If either of these things occur and you fire the gun, the gun will explode, damaging the gun and possibly causing serious injury or death to you and those around you

10. Wear protective shooting glasses and adequate ear protection when shooting.

11. Never climb or jump over anything, such as a tree, fence, or ditch, with a loaded gun. Open the barrel, remove the shells, and hand the gun to a friend

or place it on the ground on the other side of the obstacle before crossing it yourself. Do not lean a gun against a tree or other object; it could fall and possibly discharge.

12. Do not shoot at a hard surface or at water. Bullet and shot can ricochet or bounce off and travel in unpredictable directions with great velocity.

13. Never transport a loaded gun. Do not place a loaded gun into a vehicle. The gun should be unloaded and placed into a case when not in use.

14. Never drink alcoholic beverages before or during shooting.

INTRODUCTION TO TRISTAR

For many of years, Tristar has been associated with the gun industry. After the word with modern technology and you have a product of true value and affordable quality. You have Tristar

We at Tristar thank you for the privilege of delivering a product to you that will provide you with years of pleasurable use. Happy shotgunning.

ABOUT YOUR SEMI-AUTOMATIC SHOTGUN

Your Tristar shotgun is gas operated. The gas created from firing a live shotshell operates the action. Once the first shell has been fired, the next shell in the magazine will automatically cycle into the chamber, and this cycle will continue (each time the trigger is pulled) until all shells loaded in the magazine have been fired. The bolt will remain locked in the open position after the last shell is fired.

The technologically advanced gas metering system allows you to shoot 2 3/4" and 3" shells interchangeably with any ammunition of the proper gauge for your shotgun with flawless performance. This and other fine features ensure that your shotgun will be a source of pride and pleasure for years to come. For 3 1/2" models the metering system allows you to shoot heavy 2 3/4", 3" and 3 1/2" shells interchangeably.

SAFETY SWITCH OR BUTTON

The safety is designed to stop the trigger mechanism.

DON'T RELY ON YOUR GUN'S SAFETY. TREAT EVERY GUN AS IF IT WERE LOADED AND READY TO FIRE. The safety on any gun is a mechanical device, and it is not intended as a substitute for common sense or safe gun handling. Always keep the muzzle pointed in a safe direction.

A. The safety is located behind the trigger, and provides protection against accidental or unintentional discharge under normal usage when properly engaged.

B. To engage the safety, push the button so that it protrudes from the right side of the gun and the **RED BAND MARKING CAN NOT BE SEEN**. The safety should always be in the "on" or "safe" position until you intend to fire the gun (photo 1).

C. When you are ready to fire the gun, press the safety button to the "off" or "fire" position, so that the safety protrudes from the left side of the gun and the **RED BAND MARKING IS SHOWING**.



DANGER: The gun will fire when the trigger is pulled intentionally or accidentally when the **RED BAND MARKING IS SHOWING**.

ASSEMBLY

In the packing, the shotgun is divided into two parts: receiver and barrel group (photo 2).



To assemble the gun, follow the steps below:

Unscrew the cap (photo 3) and remove the forend (photo 4).

Pull the bolt hanging latch placed on the rear side of the carrier (photo 5).

Assemble the barrel while centering the magazine and the receiver (photo 6).

Reassemble the forend (photo 7) and screw the cap onto the threaded magazine tube (photo 8).

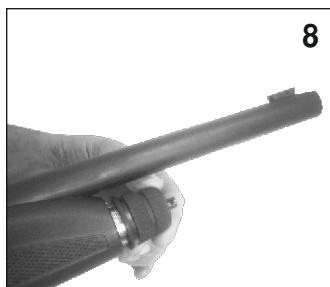
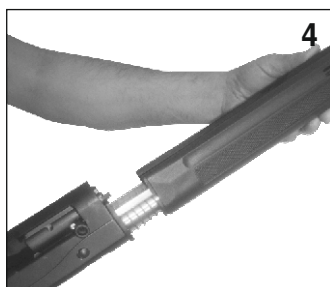
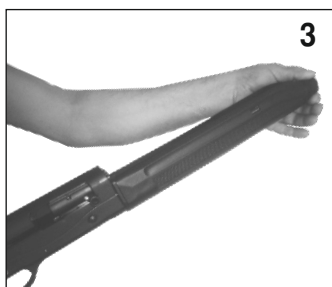

LOADING YOUR SHOTGUN

You can load your shotgun in the following ways:

1. Be certain the safety is in the "on" or "safe" position (see section regarding operation of the safety on pages 3 and 4).

Draw or pull the bolt rearward until it locks in the open position (photo 12). Place a shell into the breach (photo 9). Release the bolt by pressing the button located toward the front of the receiver (photo 10). **This chambers a round, and the gun will fire if the trigger is pulled with the safety in the "off" or "fire" position.** You can then load additional shells into the magazine by inserting them through the loading port on the bottom of the receiver and pushing them into the magazine (photo 11).

2. Be certain the safety is in the "on" or "safe" position (see section regarding operation of the safety on pages 3 and 4).

Draw or pull the bolt rearward until it locks in the open position (photo 12). Load shells into the magazine by inserting them through the loading port on the bottom of the receiver and pushing them into the magazine (photo 11). Push back the magazine shell latch on the rear side of the carrier (photo 13). This allows the shell to exit the magazine and move onto the carrier. Release the bolt by pressing the button located toward the front of the receiver (photo 10). **This chambers a round, and the gun will fire if the trigger is pulled with the safety in the "off" or "fire" position.**



UNLOADING YOUR SHOTGUN

Be certain the safety is in the "on" or "safe" position (see the section regarding operation of the safety on pages 3 and 4). Rapidly draw or pull the bolt reaward to eject any shell in the chamber (photo 12). Lock the bolt open by pressing the button located toward the front of the receiver (photo 13). Lift the carrier and push on the magazine shell latch (photo 14). The shells in the magazine will be ejected.

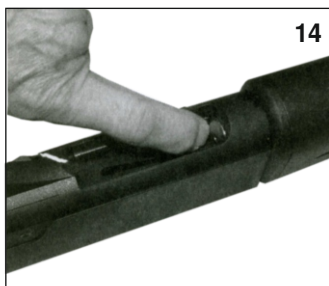

DISASSEMBLY

Unscrew the forend cap.

Take the forend and the barrel off (photo 15).

Take the handle off from the bolt and then all the bolt assembly (photo 16).

With a tool, push the pin(s) of the trigger group out (photo 17) and take the trigger group off (photo 18).

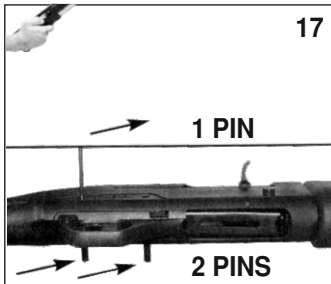
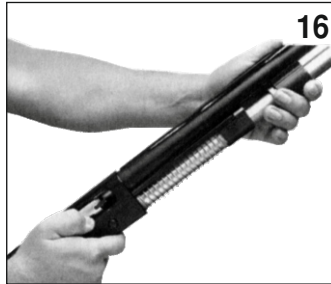
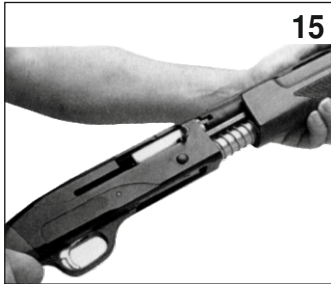

REASSEMBLY

Assemble on the magazine tube, the action spring and insert the bolt group into the receiver.

Insert the handle into its hole.

Reassemble the trigger group fixing it with the pin(s).

GENERAL ASSEMBLY

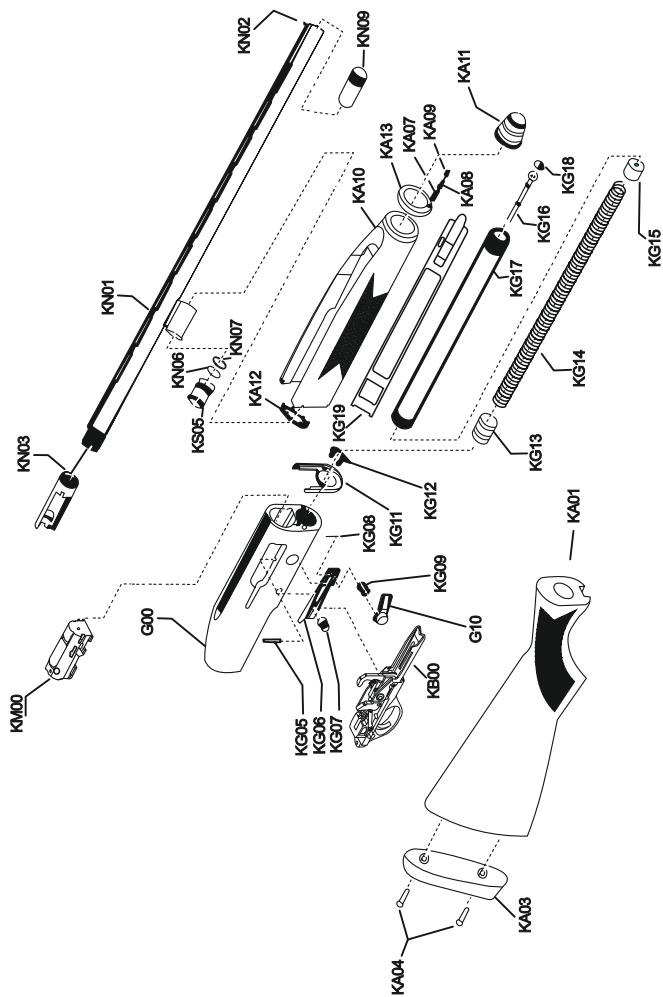

12 GA. GENERAL ASSEMBLY - PART LIST

Stock No	Description	Stock No	Description
KG00	TRIGGER GROUP ASSEMBLY	KA04	RUBBER COIL PAD SCREW
KG00	RECEIVER	KA07	FORE-END BLOCKER SPRING
KG01	RECOIL SPRING TUBE	KA08	FORE-END BLOCKER
KG03	RECOIL SPRING	KA09	FORE-END BLOCKER SCREW
KG04	RECOIL SPRING CAP	KA10	WALNUT FORE-END
KG05	CARRIER LATCH PIN	KS010	SYNTHETIC FORE-END
KG06	CARRIER LATCH	KA11	FORE-END NUT
KG07	CARRIER LATCH SPRING	KA12	FORE-END PINNED PLATE
KG08	CARRIER LATCH BUTTUN PIN	KA13	FORE-END PLATE
KG08	CARRIER LATCH BUTTUN SPRING	KN01	BARREL
KG10	CARRIER LATCH BUTTUN	KN02	FRONT SIGHT
KG11	FORE-END LATCH	KN03	BREECH
KG12	FORE-END LATCH SCREW	KN07	GAS HOLE O-RING
KG13	MAGAZINE LOGN SPRING CUP	KN09	CHOKE TUBE
KG14	MAGAZINE SPRING	KN10	GAS HOLE JOINT
KG15	MAGAZINE SHORT SPRING CUP	KN11	GAS HOLE PLUG
KG16	MAGAZINE PLUG	KS05	PISTON
KG17	MAGAZINE TUBE	KS06	PISTON O-RING
KG18	MAGAZINE PLUG BLOCKER	KS07	PISTON RING
KG19	ACTION BAR		
KA01	WALNUT STOCK		
KS001	SYNTHETIC STOCK		
KA03	RUBBER RECOIL PAD		

TRIGGER GROUP ASSEMBLY-B00

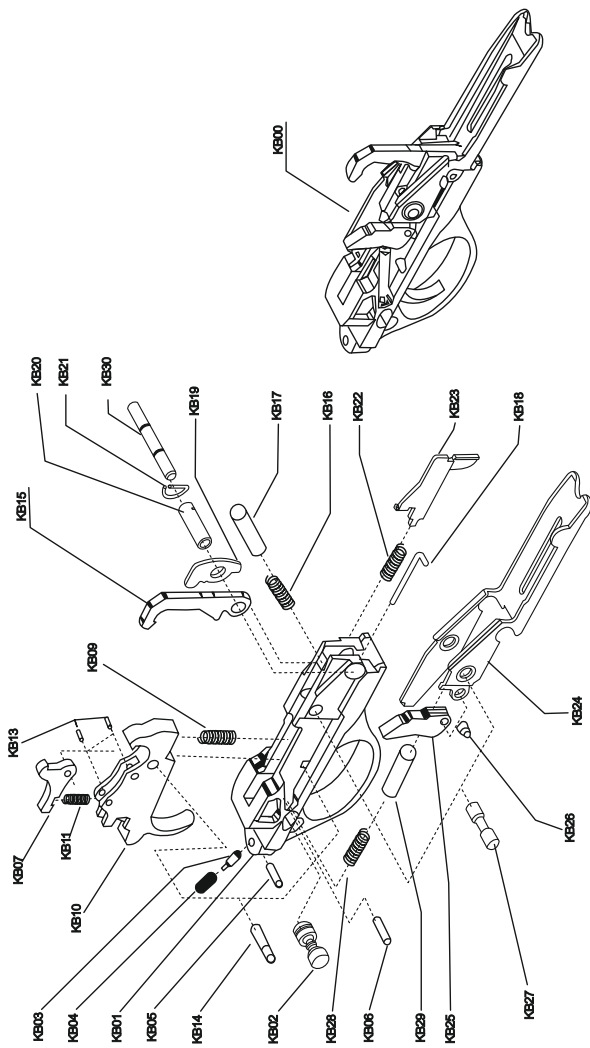

12 GA. TRIGGER GROUP ASSEMBLY - PART LIST

Stock No	Description	Stock No	Description
KB01	TRIGGER GUARD	KB17	HAMMER SPRING CAP
KB02	HAND SAFETY	KB18	HAMMER LATCH SPINDLE
KB03	SAFERY PLUNGER SPRING PIN	KB19	HAMMER LATCH
KB04	SAFERY PLUNGER SPRING	KB20	HAMMER TUBE PIN
KB05	SAFERY SPRING RETAINING PIN	KB21	HAMMER TUBE PISTON RING
KB06	TRIGGER FIXING PIN	KB22	TRIGGER GUARD LATCH SPRING
KB07	DISCONNECTOR	KB23	TRIGGER GUARD LATCH SPRING
KB09	TRIGGER SPRING	KB24	CARRIER
KB10	TRIGGER	KB25	BREECH BOLT LATCH
KB11	HAMMER DROP SPRING	KB26	BREECH BOLT LATCH PIN
KB12	HAMMER DROP PART	KB27	CARRIER PIN
KB13	HAMMER DROP PIN	KB28	CARRIER SPRING
KB14	TRIGGER PIN	KB29	CARRIER SPRING PIN
KB15	HAMMER	KB30	RECEIVER PIN
KB16	HAMMER SPRING		

BOLT GROUP ASSEMBLY-KM00

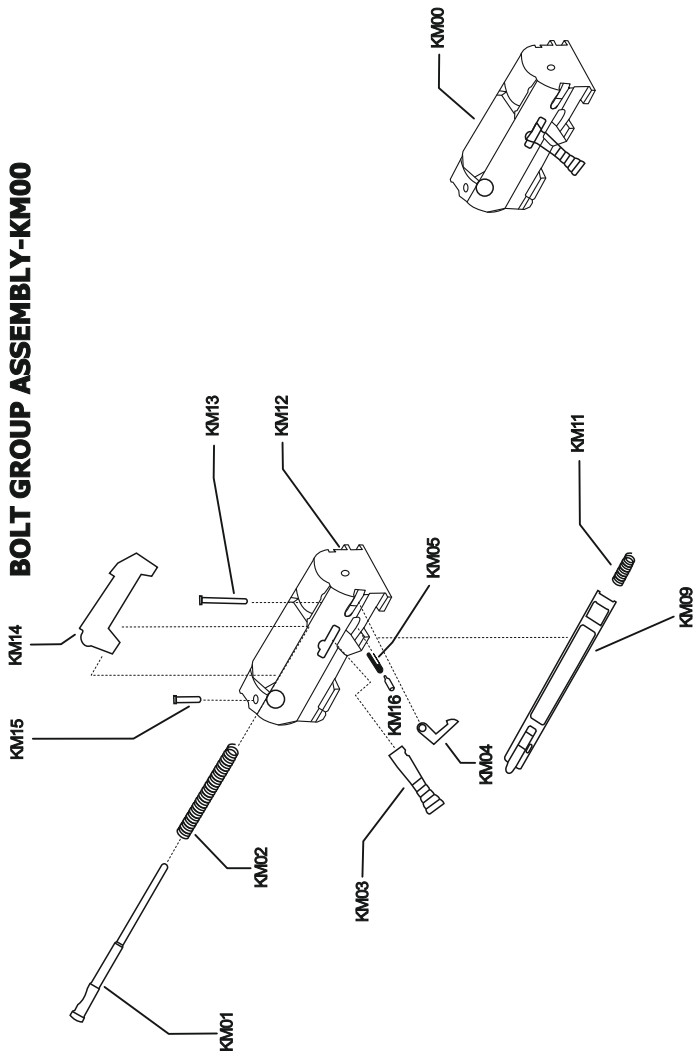

12 GA. BOLT GROUP ASSEMBLY - PART LIST

Stock No	Description
KM01	FIRING PIN
KM02	IRINING PIN SPRING
KM03	BOLT HANDLE
KM04	EXTRACTOR
KM05	EXTRACTOR SPRING
KM06	ACTION BAR
KM07	BOLT HANDLE PIN SPRING
KM08	BOLT
KM09	EXTRACTOR PIN
KM10	LOCKING BLOCK
KM11	FIRING RETAINING PIN
KM12	EXTRACTOR SPRING PIN

hamper proper functioning and will soak the wood. After extended periods of heavy use, your gun should be taken to a qualified gunsmith to have the action disassembled for professional cleaning and lubrication.

3. Care for your wood stock and forearm the same way you would a piece of furniture with the same finish.

STORAGE

Clean thoroughly and oil your gun before storage. Store the gun in a case to prevent scratches and dents. Store in a dry place to prevent corrosion. **Store the gun away from children and in place where it cannot be obtained by those unauthorized to use it. Always store gun unloaded and separately from any ammunition.**

IMPORTANT

USAGE OF STEEL SHOT

The choke (bore constriction) in all modern shotguns has been established based on the pattern performance of shot shells loaded with lead shot. When using the steel shot shells, you will notice a different performance in pattern density versus the established lead shot pattern, because the steel shot is harder and lighter than lead shot.

You should be aware of the following differences and cautions:

Never shoot steel shot loads in a full choked barrel or full choke tubed barrel. To do so may cause the barrel to swell or rupture. In general, steel shot fired with a modified choke will produce the equivalent of a lead full choke pattern. This will be true of all steel shot sizes up to and including no. 2. The established improved cylinder chokes will produce the equivalent of a (lead) modified choke pattern.

All steel shot sized larger than no. 2, and including special sized such as -F-, "T", etc., should be used only with improved cylinder chokes. These steel shot sized, when used in improved cylinder chokes, will produce patterns equivalent to (lead) full choke patterns. The established cylinder choke or bore will produce the equivalent of a modified (lead) pattern.





Additional information concerning the use of steel shot is available from Remington, Winchester, Federal and other ammunition companies.

PARTS

To order parts, please furnish the following information: Your name, address, telephone number, firearm serial number, maker and model. When we receive your request we will send you an order form and a parts breakdown with prices.

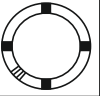
USAGE OF CHOKE TUBES

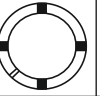
The choke is what controls the openness or tightness of the pattern of your shotgun. The chart below lists the choke available (from open to tight), and the corresponding marks that indicate the choke of your specific shotgun.

	SKEET	IC	M	IM	F	XF
CHOKE TUBE						
BBLs	C L	****	***	**	*	XF

Never fire or run gun cleaning tools through a barrel that uses choke tubes without having a choke tube installed. The threads of the choke tube and the internal threads of the barrel should be cleaned after each use and before installation of the tube.

To install a tube, insert the tube into the barrel and tighten with your fingers. Once the tube is finger tightened, tighten with the appropriate choke-tube wrench until the tube is snug. **DO NOT over tighten or forcefully tighten with wrench.**

MAINTENANCE AND CLEANING

Caution: Make sure the gun is unloaded.

1. Make sure that the broad, polished, finely fitted mating surfaces of the breech block and receiver are especially clean and lightly oiled with a high quality gun oil. Do not use pure silicone or lanolin.

2. Run an oil patch through the bore with a cleaning rod starting from the breech end. To prevent leading, use a cleaning solvent and brass brush to clean the bore periodically. Follow this cleaning with one or two clean oilpatches. **Important:** If your gun is equipped with choke tubes, do not use a brass brush to clean the barrels unless a choke tube is installed in each barrel. Barrels that utilize choke tubes must also have the choke tubes removed to clean and oil the threads inside the barrel and the choke tubes themselves. This will protect the threads from being damaged by cleaning tools and also prevent a dirt build up that would cause the choke tube to become difficult to remove from the barrel. Damage can result to choke tubes and barrel when attempting to remove sticky choke tubes.

Never fire your gun without choke tubes snugly tightened in barrels. Do not over tighten choke tubes. Wipe all exposed metal surfaces with an oiled cloth before storing. Do not squirt or pour oil into the inside mechanism because it may





SERVICE AGREEMENT AND LIMITED WARRANTY

Tristar agrees to service its products free of charge for defects in materials and workmanship in accordance with the service agreement listed below. The obligation of Tristar under this agreement is limited to the repair or replacement of unserviceable parts and does not cover any incidental or consequential damages. Other than the express warranty contained herein Tristar makes no warranties, express or implied.

Tristar will repair or replace any unserviceable part(s) for one (1) year from date of purchase and further will supply free parts (Wood not included) for an additional four (4) years in accordance with the above warranty statement provided your firearm had not been altered, abused, willfully damaged, or damaged by overpressure ammunition. This agreement is not transferable; its benefits apply only to the original purchaser.

To obtain free service during the time this agreement is in effect, make sure your firearm is unloaded, and send it to Tristar

This agreement and the warranties contained herein are void if your registration card is not received with a copy of your sales slip within 30 days from date of purchase



SHIPPING

When returning your gun for service, please take care in packing. Disassemble your gun, wrap in paper or other protective media and place gun in the original box. (THIS BOX WILL PROTECT THE GUN BUT IS NOT DESIGNED FOR SHIPPING). Wrap box in a cardboard box approved for interstate shipping. Tristar is not responsible for damage incurred during shipping.

Ship the firearm prepaid to: TriStar Arms
1816 Lim St.
North Kansas City, MO 6416

INSTALLATION OF MAGAZINE PLUG

Some Federal, State and local hunting regulation may require that a shotgun be limited to a maximum shell capacity of three (3) rounds.

Your shotgun has been packed with a magazine plug for this purpose.

Installation:

1. Remove the forend screw cap, the forend and the barrel.
2. At the threaded end of the magazine tube (where the forend screw cap fits) you will locate a black snap ring.
3. A large blade screw driver should be used to remove the snap ring.

CAUTION: The snap ring will be under pressure from the magazine spring. Do not remove the snap ring in a manner where the ring could fly out and strike you or anyone else causing injury, particularly to the eye.

4. Compress the magazine spring into the magazine tube, and insert the magazine plug (small end first). Push the magazine plug and insert the snap ring so the snap ring end is flush with the end of the tube.

THANK YOU

Thank you for purchasing a Tristar shotgun We are sure this gun will bring you years of hunting and/or shootin pleasure. Your satisfaction is the key to our success. Please let us know if we can be of service and please relay any observations about your guns performance or appearance.

PURCHASER'S RECORD

Model Number _____

Purchase Date _____

Gauge or Caliber _____

Serial Number _____

Purchase Price _____

Store Name _____

BE COURTEOUS

When shooting or hunting always acquire the permission of the landowner. Respect the land. Do not litter, use gates when possible, leave open gates open and closed gates closed. Drive vehicles only where advance permission has been granted and always express gratitude for use of another persons land. offer your labor or game as repayment for the privilege of use. Remember you are helping develop a reputation for all sportsmen/sportswomen.



TriStar

Tristar Arms
1816 Linn Street
North Kansas City, MO 64116
PHONE : 816-421-1400
Fax : 816 - 421 - 4182