

# Owner's Manual

HP18 Series

IJ500 Series

Semi-Auto Shotgun



**IMPORTANT:** Before using this shotgun, read and follow the instructions of this manual in its entirety.

Iver Johnson Arms, Inc.

PO Box 561294

Rockledge, FL 32956

Phone: 321-636-3377 Fax: 321-632-7745

[www.iverjohnsonarms.com](http://www.iverjohnsonarms.com)

# Table of Contents

<b>Shotgun Specs</b>	<b>pg. 4</b>
<b>State by State Warnings</b>	<b>pg. 7</b>
<b>Firearm Safety &amp; Warnings</b>	<b>pg. 11</b>
<b>External Parts Diagram and Descriptions</b>	<b>pg. 17</b>
<b>Shotgun Assembly – Out of the Box</b>	<b>pg. 26</b>
<b>Loading Your Shotgun</b>	<b>pg. 30</b>
<b>Firing Your Shotgun</b>	<b>pg. 32</b>
<b>Unloading Your Shotgun</b>	<b>pg. 34</b>
<b>Shotgun Disassembly</b>	<b>pg. 35</b>
<b>Shotgun Reassembly</b>	<b>pg. 38</b>
<b>Shotgun Maintenance</b>	<b>pg. 42</b>
<b>Parts List and Diagram</b>	<b>pg. 47</b>
<b>Limited Warranty</b>	<b>pg. 49</b>

## NOTICE

This shotgun, or any firearm, should not be sold, transferred, or given to any one prohibited by law to possess a firearm. Contact your local Bureau of Alcohol, Tobacco, Firearms and Explosives (BATFE) and your local law enforcement agency for information relating to the lawful sale and/or transfer of firearms

This owner's manual should always be kept with this shotgun, even if transferred to another party. If you misplace or lose this manual, contact Iver Johnson Arms directly for a replacement.

After any cleaning or disassembly of the shotgun, always re-check to make sure the shotgun functions properly before firing live ammunition.

Any mechanical alterations or modifications to the shotgun can lead to injury and/or death and will void the manufacturer warranty.

The use of reloaded ammunition can lead to injury and/or death and will also void the manufacturer warranty.

We specifically disclaim responsibility for any damage, injury or death occurring in connection with or as the result of the use of the shotgun with faulty, non-standard, remanufactured, hand loaded or reloaded ammunition, or other shotshells other than those for which the shotgun was originally chambered.

## IJ500 Specs

**\*\*Caliber:** 12ga and 20ga\*\*  
**Chamber:** 2 ¾" and 3"  
**Capacity for 2 ¾":** 5+1  
**Capacity for 3":** 4+1  
**\*\*Barrel:** 28" smooth bore\*\*  
**\*\*Overall length:** 49 inches\*\*  
**\*\*Weight:** 7lbs. 2oz. unloaded\*\*

## HP18 Specs

**\*\*Caliber:** 12ga and 20ga\*\*  
**Chamber:** 2 ¾" and 3"  
**Capacity for 2 ¾":** 5+1  
**Capacity for 3":** 4+1  
**\*\*Barrel:** 18.25" smooth bore plus muzzle brake\*\*  
**\*\*Overall length:** 40.5 inches\*\*  
**\*\*Weight:** 6lbs. 6oz. unloaded\*\*

Note: This manual applies to the IJ500 series and the HP18 series. The basic parts, operation, disassembly, reassembly, and maintenance instructions are the same for both models. The only differences are barrel lengths and the external design of the shotguns.

**\*\*New models may be available in different calibers, barrel lengths, and/or finishes. See website for updates. Capacity limits are subject to change based on up to date importation regulations\*\***

# Ammunition



Never use any type of reloaded ammunition with this shotgun. The use of reloaded or hand-loaded ammunition is dangerous and will void the warranty. We specifically disclaim responsibility for any damage, injury or death occurring in connection with or as the result of the use of the shotgun with faulty, non-standard, remanufactured, hand loaded, or reloaded ammunition for which the shotgun was originally chamber.

Good quality 12ga steel shot, lead shot, or slugs, 2 ¾" & 3" in length, with a minimum weight of 1 1/8 oz, manufactured and loaded with current U.S. industry specifications can be used in the HP18 / IJ500 12ga shotgun. Do not use low recoil shells.

Good quality 20ga steel shot, lead shot, or slugs, 2 ¾" & 3" in length, manufactured and loaded with current U.S. industry specifications can be used in the HP18 / IJ500 20ga shotgun. Do no use low recoil shells.

This shotgun functions by energy generated by gas expansion. For this reason, one must always use ammunition that is strong enough to cycle the action. The HP18 / IJ500 may require a break in period of 100-300 shells. If you experience any initial functioning issues, it is recommended that you fire 100 rounds of heavy load hunting ammunition, to get through this initial break in period.

**LEAD WARNING:** The actual firearm does not contain lead, but it does fire ammunition which contains lead or lead compounds known to the State of California to cause cancer, birth defects, reproductive toxicity, and other serious physical injuries. Those who discharge a firearm, stand near someone who discharges a firearm, or clean a firearm are hereby warned of the dangers presented by lead and lead compounds and should take protective health measures.

Avoid exposure to lead while handling and wash your hands after contact. Proper air ventilation is absolutely necessary when shooting indoors.

**AMMUNITION WARNING:** Firearms can be damaged, and death or injury may result from any condition that generates excessive pressure or uncontrolled release of gas within the firearm. These adverse conditions can be caused by chamber or bore obstructions, propellant overloads, or by old, defective, incorrect, or improperly loaded and assembled shotshell components. It is extremely dangerous to use a shotshell that's pressure exceeds those developed to industry standards. Any firearm can be blown up with excessive pressure.

### **Attention:**

Iver Johnson Arms, Inc. will not be responsible for injury, death, or damage to property which is due to intentional or accidental discharge of this firearm. Iver Johnson Arms will not be responsible for injury, death, or damage to property due to gun corrosion, gun neglect, use of incorrect ammunition caliber, use of reloaded ammunition, unapproved firearm adjustments, or unapproved part replacements. Federal, and many state, regulations have laws covering storage of firearms and safety measures for keeping them away from children. Check the laws in your state.

Before this shotgun left the factory, it was inspected and tested. Iver Johnson cannot control what happens to this shotgun after it leaves the factory. Please examine this shotgun carefully when purchased to ensure it is unloaded and undamaged.

**This manual should always go with this shotgun. If this shotgun is sold, transferred, or given away, this manual should accompany it.**

# State-By-State Warnings

Certain states require by law that their own specified warning notices in larger-than-normal type be conspicuously included by the manufacturer, distributor, or retail dealer with firearms sold in that state. Iver Johnson Arms, Inc. sells its products in compliance with applicable laws and regulations. Because our products may be sold in these states, we include the following:

## California:

**WARNING** - "Children are attracted to and can operate firearms that can cause severe injuries or death. Prevent child access by always keeping guns locked away and unloaded when not in use. If you keep a loaded firearm where a child obtains and improperly uses it, you may be fined or sent to prison."

**ADVERTENCIA** - "A los niños los atraen las armas de fuego y las pueden hacer funcionar. Ellos pueden causarse lesiones graves y la muerte. Evite que los niños tengan acceso a las armas de fuego guardándolas siempre con llave y descargadas cuando no las esté utilizando. Si usted tiene un arma de fuego cargada en un lugar en que un niño tiene acceso a ella y la usa indebidamente, le pueden dar una multa o enviarlo a la cárcel."

## Connecticut:

"UNLAWFUL STORAGE OF A LOADED FIREARM MAY RESULT IN IMPRISONMENT OR FINE."

## Florida:

"IT IS UNLAWFUL, AND PUNISHABLE BY IMPRISONMENT AND FINE, FOR ANY ADULT TO STORE OR LEAVE A FIREARM IN ANY PLACE WITHIN THE REACH OR EASY ACCESS OF A MINOR UNDER 18 YEARS OF AGE OR TO KNOWINGLY SELL OR OTHERWISE TRANSFER

# State-By-State Warnings

## Florida (con't):

OWNERSHIP OR POSSESSION OF A FIREARM TO A MINOR OR A PERSON OF UNSOUND MIND.”

## Maine:

“ENDANGERING THE WELFARE OF A CHILD IS A CRIME. IF YOU LEAVE A FIREARM AND AMMUNITION WITHIN EASY ACCESS OF A CHILD, YOU MAY BE SUBJECT TO FINE, IMPRISONMENT, OR BOTH. KEEP FIREARMS AND AMMUNITION SEPARATE. KEEP FIREARMS AND AMMUNITION LOCKED UP. USE TRIGGER LOCKS.”

## Maryland:

“WARNING: Children can operate firearms which may cause death or serious injury. It is a crime to store or leave a loaded firearm in any location where an individual knew or should have known that an unsupervised minor would gain access to the firearm. Store your firearm responsibly!”

## Massachusetts:

“WARNING FROM THE MASSACHUSETTS ATTORNEY GENERAL: This shotgun is not equipped with a device that fully blocks use by unauthorized users. More than 200,000 firearms like this one are stolen from their owners every year in the United States. In addition, there are more than a thousand suicides each year by younger children and teenagers who get access to firearms. Hundreds more die from accidental discharge. It is likely that many more children sustain serious wounds, or inflict such wounds accidentally on others. In order to limit the chance of such misuse, it is imperative that you keep this weapon locked in a secure place and take other steps necessary to limit the possibility of theft or accident. Failure to take reasonable preventative steps may result in innocent lives



# State-By-State Warnings

## Massachusetts (con't):

being lost, and in some circumstances may result in your liability for these deaths.”

“IT IS UNLAWFUL TO STORE OR KEEP A FIREARM, RIFLE, SHOTGUN, OR MACHINE GUN IN ANY PLACE UNLESS THAT WEAPON IS EQUIPPED WITH A TAMPER-RESISTANT SAFETY DEVICE OR IS STORED OR KEPT IN A SECURELY LOCKED CONTAINER.”

## New Jersey:

“IT IS A CRIMINAL OFFENSE TO LEAVE A LOADED FIREARM WITHIN EASY ACCESS OF A MINOR.”

## New York City:

“THE USE OF A LOCKING DEVICE OR SAFETY LOCK IS ONLY ONE ASPECT OF RESPONSIBLE FIREARMS STORAGE. FOR INCREASED SAFETY, FIREARMS SHOULD BE STORED UNLOADED AND LOCKED IN A LOCATION THAT IS BOTH SEPARATE FROM THEIR AMMUNITION AND INACCESSIBLE TO CHILDREN AND OTHER UNAUTHORIZED PERSONS.”

## North Carolina:

“IT IS UNLAWFUL TO STORE OR LEAVE A FIREARM THAT CAN BE DISCHARGED IN A MANNER THAT A REASONABLE PERSON SHOULD KNOW IS ACCESSIBLE TO A MINOR.”

## Texas:

“IT IS UNLAWFUL TO STORE, TRANSPORT, OR ABANDON AN UNSECURED FIREARM IN A PLACE WHERE CHILDREN ARE LIKELY TO BE AND CAN OBTAIN ACCESS TO THE FIREARM.”

# **State-By-State Warnings**

## **Wisconsin:**

“IF YOU LEAVE A LOADED FIREARM WITHIN THE REACH OR EASY ACCESS OF A CHILD YOU MAY BE FINED OR IMPRISONED OR BOTH IF THE CHILD IMPROPERLY DISCHARGES, POSSESSES, OR EXHIBITS THE FIREARM.”

\*\*\*\*\*

Please check with your licensed retailer or state police for additional warnings which may be required by local law or regulation. Such regulations change constantly, and local authorities are in the best position to advise you on such legal matters and requirements.

# Firearm Safety and Warnings

## YOU RISK PERSONAL INJURY OR DEATH BY HANDLING THIS FIREARM

Before handling any firearm, make sure you know the safety procedures and most importantly, keep the firearm pointed in a safe direction.

Before handling this shotgun, read, understand and follow the instructions in this manual. Always keep this manual with the shotgun. If you lend, give or sell this shotgun, be sure the manual goes with it. If there is anything you do not understand, seek advice from someone qualified in safe handling of firearms. You must ALWAYS obey the following:

### THE TEN COMMANDMENTS OF FIREARM SAFETY

1. Always keep the muzzle pointed in a safe direction, away from any person, animal, dwelling, vehicle, or anything else that could be injured or damaged.
2. Firearms should be unloaded and secured when not actually in use.
3. Do not rely on your firearm's safety.
4. Be sure of your target and what is beyond it.
5. Use only proper ammunition matching the precise gauge of your specified shotgun.
6. If your shotgun fails to fire when the trigger is pulled, handle with care. Keep it pointed in a safe direction until you are able to safely unload it.
7. Always wear ear and eye protection when shooting.

8. Be sure the barrel is clear of obstructions before shooting.
9. Do not alter or modify your firearm, and have it serviced regularly.
10. Learn the mechanical and handling characteristics of your shotgun.
11. Shoot sober!

## **FOLLOWING THESE SAFETY RULES CAN SAVE YOUR LIFE OR THE LIFE OF SOMEONE ELSE**

Get competent firearms instruction in safe handling before using this shotgun. Please ask your dealer for names of qualified instructors near you. All guns are extremely dangerous if carelessly handled or used. Remember that the firearm user is the primary “safety” and that reliance on any mechanical safety device should never replace safe handling procedures.

This shotgun **WILL FIRE** if a shotshell is in the chamber and the trigger is pulled while the safety is disengaged.

**DO NOT LOAD THIS SHOTGUN UNTIL YOU UNDERSTAND HOW IT OPERATES.** Keep this shotgun unloaded at all times except when you are ready to fire and are sure of your target.

**ALWAYS** carry this shotgun in a case or the original box **unloaded.**

**NEVER** point this shotgun at anything that is not your intended target even if the shotgun is unloaded. When loading, unloading, cleaning or handling, always be sure the muzzle is pointed in a safe direction and always keep your finger off the trigger.

## **FOLLOWING THESE SAFETY RULES CAN SAVE YOUR LIFE OR THE LIFE OF SOMEONE ELSE**

**NEVER** assume any gun is unloaded. Before handling, check to make sure the chamber is empty. See Unloading Instructions on pg 26. Make sure you know that this or any firearm is fully unloaded before displaying or handling it. When handling any firearm, keep your fingers away from the trigger at all times until you intend to fire.

Get instructions from a competent firearms instructor before using this or any firearm. Learn from a professional how to handle, load, unload, operate, fire and care for your gun.

**NEVER PLAY** with your firearm. It is not a toy and can be a very dangerous weapon that can cause serious personal injury or death.

Always keep the gun pointed in a safe direction. Treat every gun as if it is loaded...all the time. **NEVER** point any firearm (loaded or unloaded) at any person or anything you do not intend to shoot. Always keep your gun unloaded until ready to use and make sure that it is unloaded before cleaning.

Keep your finger **OFF** the trigger until you are actually aiming at the target and ready to shoot. Learn to rest your finger outside of the trigger guard.

Never rely on a firearm's "safety" to protect you from unsafe gun handling. A safety is only a mechanical device, not a substitute for using common sense and following gun safety procedures.

Never leave a gun unattended or where it could fall.

## **FOLLOWING THESE SAFETY RULES CAN SAVE YOUR LIFE OR THE LIFE OF SOMEONE ELSE**

Always store guns and ammunition separately, **beyond the reach of children**. Make sure your guns and ammunition are properly secured so untrained individuals and children will be denied access to your guns and ammunition.

Test your gun's operation and safeties only at a shooting range while the firearm is pointed in a safe direction.

Know your target and what is beyond. Ask yourself what your projectile will hit if it misses the target or passes through the intended target. Remember, a fired projectile can travel over a mile (including a ricochet) and is capable of going through walls. Never shoot at hard flat surfaces or water....bullets ricochet.

Guns, alcohol and/or drugs do not mix. Do not take any alcoholic beverages and/or drugs before or during shooting activities.

Never pull a gun toward you by the muzzle. Do not climb a tree, or cross a ditch or fence with a loaded gun.

Always empty guns before entering a house, car, truck, boat, RV, camp, or any other building or mode of transportation.

When receiving a gun, always open the action and check to make sure the chamber is unloaded while keeping your finger off the trigger and out of the trigger guard.

**NEVER** accept anyone's word that a gun is "unloaded" or "empty". You should immediately open the action and check to make sure it is unloaded, again keeping your finger off the trigger.

## **FOLLOWING THESE SAFETY RULES CAN SAVE YOUR LIFE OR THE LIFE OF SOMEONE ELSE**

Be careful with **ALL** ammunition. Even “blank” cartridges are deadly at close range due to the muzzle blast. Make sure your ammunition is new and in good clean condition. Do **NOT** oil or grease ammunition as this may damage the shotshell primer. Do **NOT** tamper with or alter the standard factory ammunition.

Keep firearms unloaded when not actually in use. Load the gun only when on the range preparing to fire, and unload it before leaving the range.

Never put your hand over the muzzle of a gun.

**ALWAYS WEAR** protective shooting glasses and hearing protection when using firearms.

Spectators should be at least 10 feet behind and away from the shooter while the shooter is loading, shooting, and unloading. Spectators should wear eye and ear protection and avoid distracting those shooting their firearms.

Never drop your gun. If you do drop it, unload it and check to ensure the shotgun functions properly before using it again.

Do **NOT** alter or modify your shotgun. Do not try to change your gun’s trigger pull, because it may affect sear engagement and thereby cause accidental firing. Any alterations and/or modifications to your shotgun will void the warranty.

Do **NOT** remove any internal safety or external safety devices on the firearm. Safety mechanisms are designed to help protect you from personal injury or death. Any alterations and/or modifications to your shotgun will void the warranty.

## **FOLLOWING THESE SAFETY RULES CAN SAVE YOUR LIFE OR THE LIFE OF SOMEONE ELSE**

Properly maintain and keep your shotgun clean. Keep it in a dry place away from other metals and water. If your gun shows sign of corrosion or improper operation, have it serviced by a competent gunsmith.

Keep the muzzle pointed in a safe direction when loading and unloading your gun. Never point the muzzle at anyone.

Never let water, snow, mud, or other material enter the barrel. Always be sure the barrel is free of any obstruction.

Use the correct ammunition for your firearm. Do **NOT** use the wrong size or wrong strength ammunition in your firearm.

**Teach children: 1. NOT** to touch guns, bullets, cartridges, shells, flares, or any explosive device and **2.** That if they discover such a dangerous item or weapon, they must immediately report its location to their parents, school teacher, or police.

Remember a firearm has the capability of taking your life or the life of someone else. Be careful with your firearm - an accident is almost always the result of not following basic safety rules.



## Basic External Parts of the IJ500 series



## Basic External Parts of the HP18 series

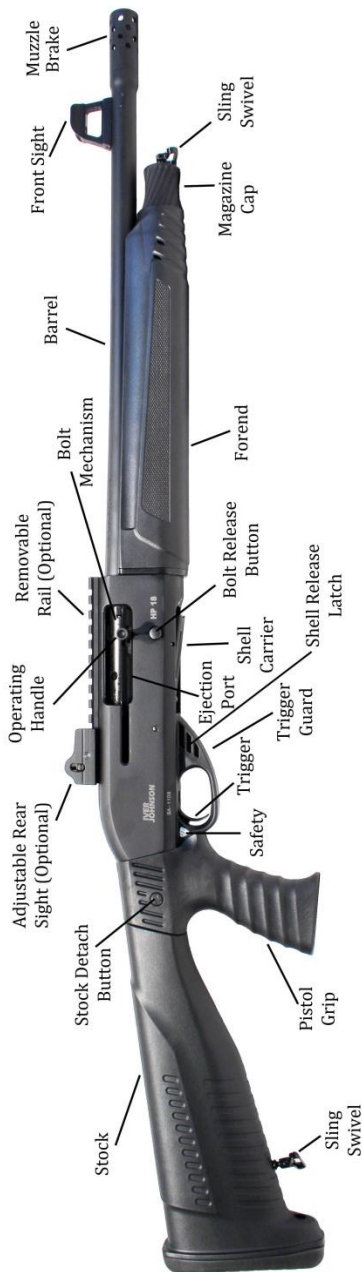

## Important Parts Description

### **Trigger:**

**Warning:** Do not touch the trigger until you are ready to fire. Pulling the trigger will fire the shotgun.

**Warning:** Do not alter or modify the trigger or firing mechanism.

**Warning:** It is recommended that you do not dry fire your shotgun, which means do not pull the trigger with an empty chamber. We recommend using snap caps or dummy rounds. This will cushion the strike of the firing pin. Dry firing your shotgun can damage the firing pin hole. You can visit our website to purchase dummy rounds.

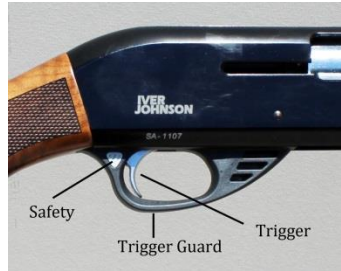

Once the shotgun is loaded, one pull of the trigger will fire one shotshell. After firing, the spent shell will eject, and the next shell will load automatically. You can continue pulling the trigger and a shell will fire every time, until the chamber and magazine tube are empty. See “Firing your Shotgun” for further instruction.

**Safety Mechanism:** The safety mechanism is located on the back end of the trigger guard, as shown in the picture above. The safety is marked on the left side with a red band. When the safety is pushed to the right from the left side, no red will be visible on the left, as shown in figure 1 page 21. This means the safety is engaged and in “safe” mode. When the safety is pushed to the left from the right side, there will be a red band visible on the left side of the safety, as shown in figure 2 page 21. This means the safety is off, and the shotgun is in “fire” mode.

**Warning:** If you pull the trigger with the safety in “fire” mode, the shotgun will fire.

**Warning:** Regardless of the position of the safety, always treat this firearm as if it is loaded and ready to fire by pointing the shotgun in a safe direction at all times, and keeping your finger off the trigger. Always put the safety in “safe” mode when you are handling, loading, unloading, or storing your shotgun.



Figure 1



Figure 2

**Warning:** Even if the shotgun is in “safe” mode and the red band is not showing, do not pull the trigger. Never pull the trigger unless you are ready to fire the shotgun.

**Warning:** Immediately after firing the shotgun, put the safety in the “safe” position. The safety should always be in the “safe” position, except for when you are actually firing the shotgun.

**Warning:** Any time you are moving the safety mechanism, keep your fingers off the trigger. Do not put your finger on the trigger until you are ready to fire.

**Bolt Release:** Located on the right side of the receiver, near the front. When the bolt mechanism is locked open, pressing the bolt release button will release the bolt, allowing the action to close shut, as in figure 3. If a shotshell is placed in the ejection port before closing the bolt, when you press the bolt release, it will load the shotshell into the chamber. See “Loading your Shotgun” for further instruction.

**Warning:** Always have the safety in “safe” mode when opening or closing the bolt mechanism.

**Warning:** Once the bolt closes and loads a shotshell into the chamber, the shotgun is now loaded and ready to fire.

**Warning:** When pressing the bolt release button, keep your hands and fingers away from the bolt mechanism and the operating handle. The bolt will close quickly and with force which could cause personal injury.



Figure 3

**Shell Release Lever:** Located on the bottom left hand side of the receiver, in the front corner of the trigger assembly, figure 4. When the magazine tube is loaded, and there are no shells in the chamber, pressing this lever will release the first shell for loading.

Also, if the shell carrier is unlocked and there are no shells in the magazine tube, pressing this lever will lock the shell carrier, which will allow the shooter to pull back the bolt handle and lock the bolt open.



Figure 4

 **Warning:** Never push the shell release lever unless the safety is in “safe” mode.

**Choke Tubes:** Your IJ500 shotgun comes with 3 internal choke tubes. Each choke tube is marked on the end with a series of notches. Notches indicate the following:

- 1 notch = Full choke
- 2 notches = Improved Modified
- 3 notches = Modified
- 4 notches = Improved Cylinder
- 5 notches = Skeet

A choke wrench is included with your shotgun. Use this wrench to remove and install the choke tubes.

 **Warning:** Never attempt to change, tighten, or adjust your choke tubes in any way while the shotgun is loaded.

To change the choke tubes:

1. Point the shotgun in a safe direction.
2. Put the safety in “safe” mode with no red showing.
3. Pull back the bolt and visibly check to ensure there is no shotshell in the chamber or magazine tube, as in figure 5 and 6.



Figure 5



Figure 6

4. Put the choke tube wrench in the tube and turn counter-clockwise.
5. Remove the existing choke tube and put the desired choke tube in the barrel.

6. Tighten the choke tube with the choke wrench by turning clockwise. Do not over tighten. Just make it snug.
7. The choke tubes should sit flush with the barrel when fully tightened, or just below, as shown in Figure 7.
8. Check the choke tubes occasionally to ensure they do not come loose.

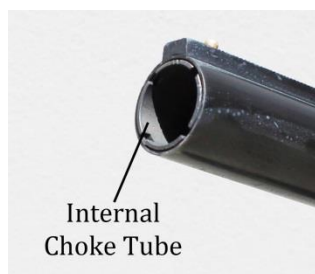

Figure 7

**Warning:** Never fire this shotgun without the choke tubes installed, or with the choke tubes protruding from the barrel. They should be fully tightened and flush or just below the end of the barrel.

**Note:** The HP18 series shotgun does not come with internal chokes. As an option, it can come with an external threaded muzzle brake.



## Operation of Semi-Auto Shotgun

**IMPORTANT!!!** Anytime you pick up your shotgun, first always check to make sure the safety is in “safe” mode, as in figure 1 page 20 . Then ensure there are no rounds in the chamber, before doing anything else, as shown in figure 5.

**Note:** Your IJ500 may come with a magazine plug in the magazine tube, to obey hunting laws in some states. This will limit your capacity to a 2 shotshell maximum in the tube. To remove this plug, make sure the magazine tube is empty, take off the magazine cap, figure 9, and pull out the black plastic plug. It will be sitting just higher than the magazine tube. You will now have a full capacity magazine tube.

### Shotgun Assembly out of the Box:

**Warning:** Always wear eye protection when assembling or disassembling your firearm to prevent injury from compressed springs or other parts.

1. This shotgun, new in the box, will be partially disassembled. The forend will be attached to the receiver and magazine tube, and the barrel will be detached.
2. Make sure the safety is in “safe” mode, as shown in figure 1.
3. Unscrew and remove the magazine cap by turning it counter-clockwise, figure 8.



Figure 8

4. Slide the wood forend forward and off of the magazine tube.
5. After removing the forend, you will see the barrel locking nut, which is only in this position during shipping, figure 9. Unscrew the locking nut and remove it from the magazine tube.
6. Slide off and remove the gas piston, figure 9.

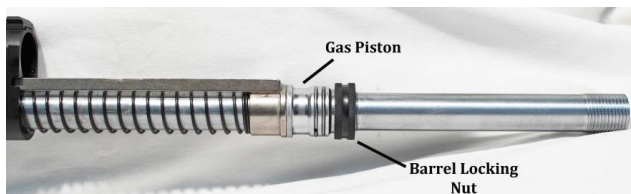

Figure 9

7. Slide the gas piston into the gas cylinder of the barrel, figure 10, before installing the barrel into the receiver.

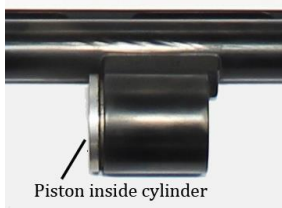

Figure 10

8. Line up the barrel notch on the rear of the barrel with the barrel slot on the front of the bolt, figure 11.

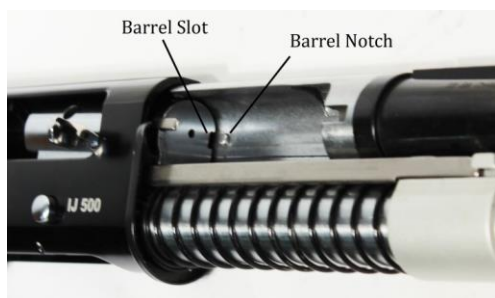

Figure 11

9. While lining up the barrel notch and the slot in the bolt, slide the barrel rearward into the receiver, with the gas cylinder sliding around the magazine tube, figure 12. As you are pushing the barrel into the receiver, at the same time, pull back on the charging handle of the bolt, until you are fully rearward and the barrel is completely seated in the receiver, as in figure 13. Once fully seated, you can slowly release the bolt until closed.



Figure 12



Figure 13

10. Screw on the barrel locking nut until it is pressing tightly against the gas cylinder of the barrel, figure 14, with the teeth of the nut against the cylinder.



Figure 14

11. Slide the wood forend around the magazine tube and all components until it seats into the forend support plate, figure 15 and 16.



Figure 15



Figure 16

12. Make sure the magazine cap support is installed at the front end of the forend, as in figure 17, and screw on the magazine cap until hand tight.



Figure 17

## Loading your Shotgun:

1. Put the safety in “safe” mode, where the red band on the left hand side of the safety is not showing.
2. Point the shotgun in a safe direction.

### Loading 1 round into the chamber:

1. Make sure shell carrier is locked by pressing the shell release lever, as in figure 4.
2. Pull back the operating handle until the bolt locks open, figure 18.

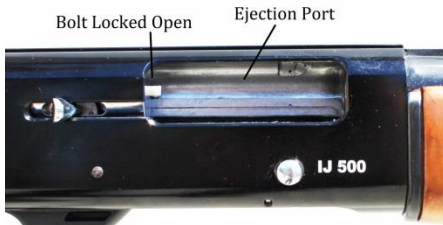

Figure 18

3. Place a shotshell of the correct gauge and length into the ejection port, figure 19.

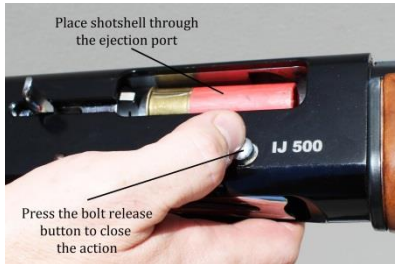



Figure 19

4. Press the bolt release button to close the action and load the shotshell into the chamber.

 **Warning:** Keep your hands and fingers away from the operating handle and the bolt when pressing the bolt release button, to avoid personal injury.

 **Warning:** The shotgun is now loaded and ready to fire. Keep your fingers away from the trigger until ready to fire, even when the safety is in “safe” mode.

Loading shotshells into the magazine tube with a shotshell already in the chamber:

1. With the safety still in “safe” mode, the shell carrier should be free moving.
2. Press the next shotshell into the shell carrier, exposing the magazine follower, figure 20.



Figure 20

3. Push the shotshell, of correct gauge and length, completely into the magazine tube until it clicks into place in the tube, figure 21 and 22.



Figure 21

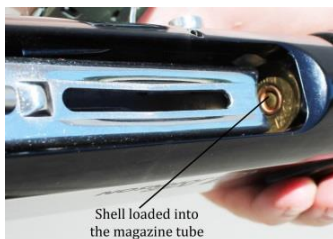

Figure 22

4. Repeat this process until the magazine tube is full. It should hold five 12ga shotshells with a length of 2  $\frac{3}{4}$  inch, and it should hold four 12ga shotshells with a length of 3 inch.

## Loading shotshells into the magazine tube without putting one in the chamber:

1. With the safety in “safe” mode, turn the shotgun upside down so you can see the shell carrier.
2. If the shell carrier is locked, you will need to press the bolt release button, figure 3, and at the same time push in the shell carrier. This will unlock the shell carrier, so you can begin loading shells into the magazine tube.
3. Now you can load the magazine tube using the same process as listed on page 30.

## Firing your Shotgun:

1. If you already have a shotshell loaded in the chamber and shotshells are loaded in the magazine tube, do not press the shell release lever. It will jam after the first shell fires.
2. If you are ready to fire, push the safety into “fire” mode, which will show a red band on the left hand side of the safety.

 **Warning:** Your shotgun is now in “fire” mode and will fire if you pull the trigger.

3. One pull of the trigger will fire one shotshell. This shotgun is a semi-automatic shotgun, which means when you pull the trigger and a shotshell fires, it will automatically eject the fired shell and automatically load the next “live” shotshell.

 **Warning:** After firing one shotshell, if there are more shotshells loaded in the magazine tube, the next shotshell will load automatically and is immediately ready to fire with your next trigger pull.

4. After firing the first shotshell, each subsequent trigger pull will fire the next round, and will continue

to do so until the chamber and the magazine tube are empty.

5. When the last shotshell is fired, the bolt will lock open.
6. Put the safety into “safe” mode.
7. To continue shooting, follow the loading procedures from page 29.

### Firing your shotgun when the magazine tube is loaded and the chamber is not:

1. With the safety still in “safe” mode, press the shell release lever, figure 4. This will release the first shotshell from the magazine tube and the shotshell will sit inside the receiver, below the bolt, ready to load into the chamber, figure 23.



Figure 23

2. Pull back on the operating handle, pulling the bolt fully to the rear. When the bolt is all the way back, release the operating handle and the shotshell will load. Make sure to completely remove your finger from the operating handle and the bolt, to avoid personal injury. It will close with force.

 **Warning:** The shotshell is now loaded in the chamber and ready to fire. Do not touch the trigger until ready to fire, even if the safety is in “safe” mode.

3. You can now follow steps 2 through 7, starting on page 31, under “Firing your Shotgun”.



## Unloading your Shotgun:

1. Make sure that your safety is in “safe” mode and your shotgun is pointed in a safe direction.
2. Turn your shotgun upside down so you can see the shell carrier, with the shotgun still pointed in a safe direction.
3. With one hand, push in the shell carrier with your thumb, and hold your thumb against the base of the first shotshell in the magazine tube.
4. While holding your thumb on the shotshell, press the bolt release button. This will release the shotshell from the magazine tube, as in figure 24 and 25.



Figure 24



Figure 25

 **Warning:** Keep your thumb on the base of the shotshell until all tension is released. The shell will come out of the magazine tube with force and can cause personal injury.

5. Continue repeating steps 3 and 4 until the magazine tube is empty.
6. After visually verifying the magazine tube is empty, hold the shotgun ejection port over a table, or another surface that can catch the ejecting shotshell, and pull back firmly on the operating handle, until the bolt is completely rearward.

7. The shotshell that is in the chamber should eject once the bolt is pulled completely rearward. If not, while holding the bolt rearward, turn the shotgun sideways to allow the shotshell to fall out of the ejection port.

 **Warning:** You should always visually verify that the chamber and the magazine tube are empty, as in figure 5 and 6.

### **Shotgun Disassembly:**

 **Warning:** Before attempting any disassembly of this shotgun, make sure the safety is in “safe” mode, as shown in figure 1 page 20.

1. Press the shell release lever, figure 4, to ensure the shell carrier is locked.
2. Pull back the bolt by grabbing the operating handle and pulling rearward, until the bolt locks back and the action remains open.
3. Visually check to ensure the chamber is empty and the magazine tube is empty, as in figure 5 and 6.
4. Once the chamber and magazine tube are empty, hold the bolt handle with one hand and press the magazine release button, figure 3, with the other to release the bolt and guide it slowly closed to avoid slamming on an empty chamber.
5. Unscrew and remove the magazine cap by turning it counter-clockwise, figure 8.
6. Slide the wood forend forward and off the magazine tube, figure 26.



Figure 26

7. Unscrew and remove the barrel locking nut, figure 27.



Figure 27

8. While holding the receiver in one hand and the barrel in the other, pull the bolt handle rearward about a quarter of the way. This will release the barrel. At the same time, pull the barrel away from the receiver and off of the magazine tube, figure 28.



Figure 28

9. With your finger, press the face of the bolt into the receiver a little bit to release the pressure on the operating handle, as in figure 29.



Figure 29

10. While pressing the bolt in, pull out the operating handle, figure 30. It will snap free. Sometimes when new, the charging handle can be tight, and you may need to use a flat head screw driver to pry loose, figure 31. Make sure to put a thick cloth over the receiver so the screw driver does not mar the finish.



Figure 30



Figure 31

 **Warning:** The bolt is under a lot of tension. Once the operating handle is removed, the bolt can spring out of the receiver and cause personal injury.

11. Slowly release the bolt until it slides out the front of the receiver and all tension is released, figure 32. Take note that the bolt is not fixed to the action bar. If you do not hold on to the bolt at this point, it will fall from the receiver. Take the bolt off of the action bar and put it aside.

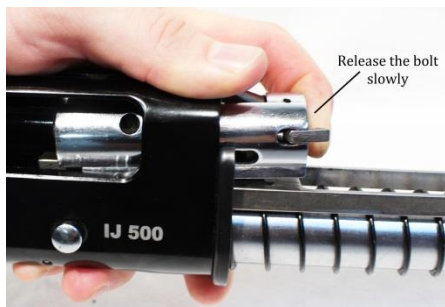

Figure 32

12. After removing the bolt, you can now slide the action bar support, the action bars, the action spring, and the forend support plate off of the magazine tube, figure 33.

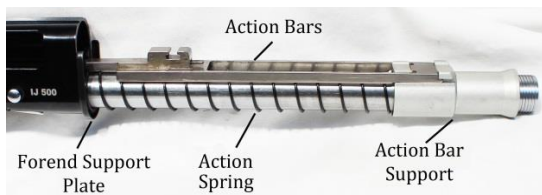



Figure 33

 **Warning: STOP** - Do not disassemble your shotgun beyond this point. No further disassembly is required for the maintenance of this shotgun. If further disassembly is needed, visit a certified gunsmith, or call Iver Johnson Arms at 321-636-3377.

### **Shotgun Reassembly:**

1. Ensure the safety is in “safe” mode.
2. Slide the forend support plate onto the magazine tube and seat it against the receiver, figure 34.

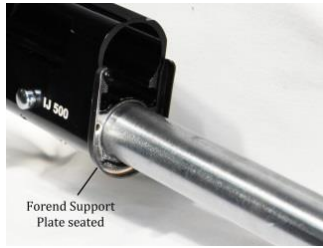

Figure 34

3. Slide the action spring and the action bar support back on to the magazine tube.
4. Attach the action bars back to the action bar support. Insert the front edge of the action bar onto the action bar support at an angle and then lay it down flat, as in figure 35 and 36, attaching the action bar to the action bar support.



Figure 35



Figure 36

5. Place the bolt assembly on to the action bar, as show in figure 37. Make sure the bolt is horizontal to the action bar, and not resting at an angle. If it is at an angle, it can bind up in the receiver when sliding it in.

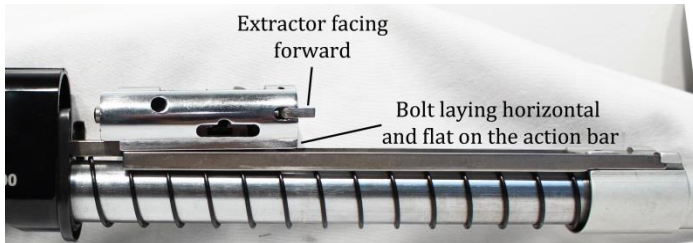

Figure 37

6. Slide the action bars and the bolt into the receiver.
7. While holding the bolt in the receiver, so you can see the bolt through the ejection port. Push the operating handle back into the bolt. Best way to do this is by holding the action bar support with one hand, gripping the action bar support to the magazine tube to hold it tight in position, as in figure 38. With the other hand, push the operating handle back into the bolt. Note: the operating handle notch in the action bar must be visible through the operating handle notch in the bolt, as in figure 39. Then line up the operating handle notch with the notch in the bolt, as in figure 40, and press it in. The operating handle will snap into place, as in figure 41.

**Warning:** When pushing the bolt into the receiver, it will be under a lot of tension from the action spring. Be careful not to release the action bar support until the operating handle is installed on the bolt, or the parts could fly off and cause personal injury. Once the operating handle is installed, release the action bar support slowly, to ensure the operating handle is properly seated.



Figure 38



Figure 39



Figure 40



Figure 41

8. Once the operating handle is installed, reinstall the barrel, as in figure 11-13.
9. Screw on the barrel locking nut until it is hand tight against the gas cylinder of the barrel, figure 14.
10. Slide the forend onto the magazine tube and seat it against the forend support plate, figure 15 and 16.
11. Make sure the magazine cap support is in place at the front end of the forend, figure 42.



Figure 42



12. Screw the magazine cap back into place and securely tighten it by hand.

Your shotgun now is fully reassembled.

### **Shotgun Maintenance:**

 **Warning:** Never clean or lubricate your firearm unless the magazine is removed and the chamber is empty.

1. To clean the barrel assembly, remove the barrel assembly from the receiver of the shotgun, following the steps of “Disassembly”.
2. Use the instructions and equipment from a good quality shotgun cleaning kit.
3. Attach a tip with a cleaning pad to a cleaning rod.
4. Dip the pad in a gun cleaning solvent.
5. Run the pad through the barrel.
6. Attach the appropriate size bore brush to the cleaning rod.
7. Run the bore brush all the way through the barrel, and then return it back out. Do this several times.
8. Take off the bore brush and put a tip with a cleaning patch back on the rod.
9. Run the cleaning patch through the barrel.
10. Do this several times, using a clean patch each time, until the patch comes out of the barrel clean.
11. Remove all dirt and shooting residue, with gun cleaner, from the bolt mechanism, the action bar, and the inside of the receiver, and then wipe dry.
12. Clean shooting residue from the locking notch near the back end of the barrel, figure 43.

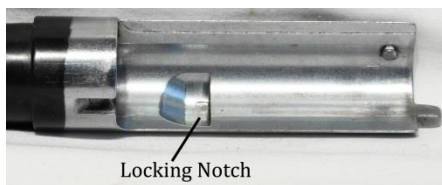

Figure 43

13. Remove the gas piston from the gas cylinder of the barrel, figure 44.

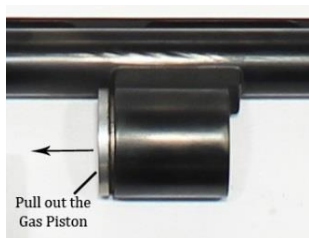



Figure 44

14. There are two gas holes inside the gas cylinder, figure 45. Check to make sure they are clean and free of obstruction. Use a 1/16" diameter wire to clean out the gas holes.



Figure 45

15. Clean any shooting residue off of the gas piston and out of the gas cylinder.
16. Put a very light coat of gun oil around the outside of the gas piston.
17. Push the gas piston back into the gas cylinder.

 **Warning:** After cleaning the barrel, make sure the barrel is free of obstruction.

## Cleaning the Choke Tubes:

1. Once again, make sure the shotgun is completely unloaded and the safety is in “safe” mode. Remove the choke tubes using the supplied choke tube wrench.
2. Clean the choke tubes with gun solvent, including the threads, and then wipe dry.
3. Apply gun oil to the threads of the choke tubes and reinstalled the tubes into the barrel (See page 24 for proper installation).

## Lubrication:

1. Once you are done cleaning your shotgun, you need to apply gun oil to certain parts of the firearm.
2. Apply a light amount of gun oil to any areas that have moving parts, including the bolt mechanism, the action bar, and the hammer assembly inside the receiver.
3. Wipe down the external metal of the shotgun with a rust preventative. Always make sure the shotgun is unloaded before wiping it down.

 **Warning:** Only use oil specifically made for firearm use. Excessive use of gun oil, or the use of oil not approved for firearm use, can adversely affect the function and safe operation of this firearm and ammunition, resulting in injury or death.

 **Lubrication Warning:** Firing a shotgun with oil, grease or any other material even partially obstructing the bore may result in damage to the shotgun and personal injury to the shooter and those nearby. Do not spray or apply lubricants directly on ammunition. If the powder charge of a cartridge is affected by the lubricant, it may not fully ignite, yet the energy from the primer and/or powder may still be sufficient to push the projectile or wad into the bore where it may

become lodged. Firing a subsequent cartridge into the obstructed bore will damage the shotgun and may cause personal injury to the shooter and those nearby. Use lubricants properly. You are responsible for the proper care and maintenance of your firearm and ammunition.

**Note:** You should clean your shotgun after every use in order to help prevent corrosion and keep your shotgun functioning correctly. If your shotgun gets wet, clean it as soon as possible. If your shotgun is not being used, you should still clean it at least twice a year, and keep it lubricated with gun oil.

### **Barrel Obstruction:**

1. To check the inside of the barrel for any obstruction, remove the magazine, lock open the bolt by depressing the bolt release latch, and switch safety "On".
2. Once the chamber is clear, insert a cleaning rod into the muzzle, which is the front of the barrel, and run it through the entire barrel until you can see it through the ejection port.
3. If the cleaning rod does not come through to the ejection port, remove the barrel by following the disassembly instructions.
4. Insert the correct size cleaning rod into the muzzle and lightly tap on the rod to free any obstructions.
5. If the obstruction does not come free, call Iver Johnson at 321-636-3377, or visit a certified gunsmith for further help.

 **Warning:** Never try to remove an obstruction in the barrel by loading and firing another shotshell. Doing so may cause the barrel to burst or the shotshell to rupture, causing severe personal injury.



**Warning:** This firearm was manufactured to properly perform with the original parts as designed. It is your duty to make sure any parts you buy are correctly installed and that neither replacements nor originals are altered or changed. Your shotgun has many parts that must relate correctly to other parts for safe and accurate operation. Putting a gun together wrong or with modified parts can result in a damaged gun, or personal injury or death to you or others. Always have a certified gunsmith work on your gun. Firearms safety is your primary concern. **THE GUN OWNER MUST ACCEPT FULL RESPONSIBILITY FOR THE CORRECT REASSEMBLY AND FUNCTIONALITY OF THE FIREARM AFTER ANY DISASSEMBLY OR REPLACEMENT OF PARTS.**

# Parts Illustration

## II500 & HP18 Series

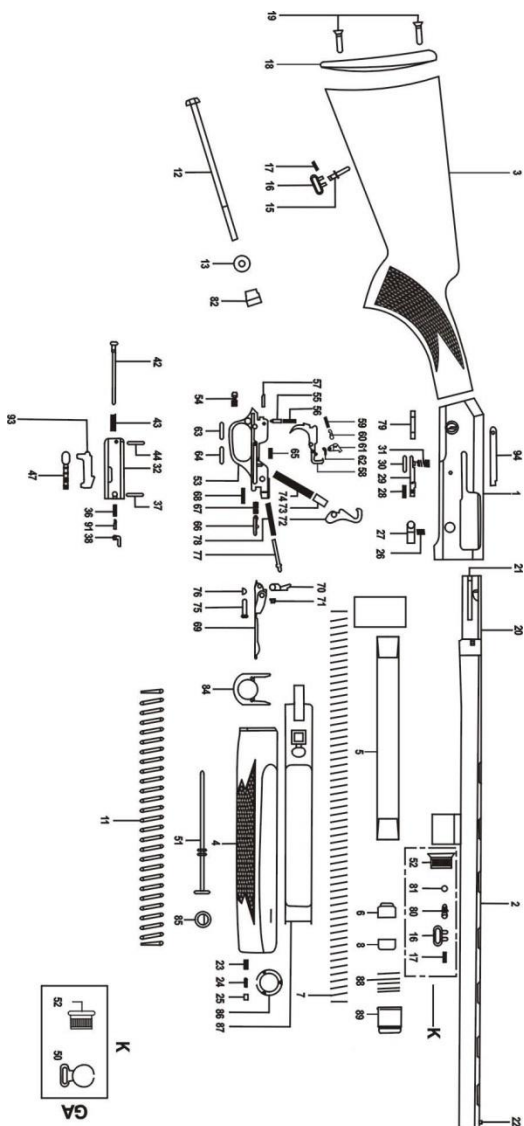

This parts illustration is a reference for identification purposes only. It is not meant as an aid for disassembly.

# Parts List

PART NO	DESCRIPTION
1	RECEIVER
2	BARREL
3	STOCK
4	FOREARM
5	MAGAZINE TUBE
6	MAGAZINE FOLLOWER
7	MAGAZINE SPRING
8	MAGAZINE SPRING RETAINER
11	ACTION SPRING
12	STOCK BOLT
13	STOCK BOLT WASHER
15	STOCK SWIVEL STUD
16	STOCK SWIVEL
17	STOCK SWIVEL PIN
18	BUTT PLATE
19	BUTT PLATE SCREW
20	BEARING BOLT
21	EJECTOR
22	FRONT BEAD
23	MAGAZINE CAP SPRING
24	MAGAZINE CAP PIN
25	MAGAZINE CAP SCREW
26	BOLT RELEASE SPRING
27	BOLT RELEASE
28	BOLT RELEASE PIN
29	BOLT RELEASE LATCH
30	BOLT RELEASE LATCH PIN
31	BOLT RELEASE LATCH SPRING
32	BRECH BOLT
36	EXTRACTOR SPRING BOLT
37	EXTRACTOR RETAINING PIN
38	EXTRACTOR
42	FIRING PIN
43	FIRING PIN SPRING
44	FIRING PIN RETAINER
47	OPERATING HANDLE
50	FRONT SWIVEL
51	MAGAZINE PLUG

PART NO	DESCRIPTION
52	MAGAZINE CAP
53	GUARD
54	SAFETY
55	SAFETY PLUNGER
56	SAFETY SPRING
57	SAFETY PLUNGER
58	TRIGGER
59	SEAR SPRING
60	SEAR PLUNGER
61	SEAR
62	SEAR PIN
63	TRIGGER PIN
64	TRIGGER PIN
65	TRIGGER SPRING
66	SHELL RELEASE LEVER
67	CARRIER SPRING
68	CARRIER RETAINING PIN
69	CARRIER
70	CARRIER LATCH
71	CARRIER LATCH PIN
72	HAMMER
74	HAMMER PLUNGER
75	HAMMER SPRING
76	HAMMER ASSEMBLY PIN SLEEVE
77	TRIGGER ASSEMBLY PIN RETAINER
78	CARRIER LATCH PLUNGER
79	TRIGGER GUARD
80	SWIVEL STUD
81	SWIVEL STUD RETAINER
82	STOCK BOLT RECEIVER
84	PLATE
85	MAGAZINE PLUG RETAINER
86	MAGAZINE CAP SUPPORT
87	ACTION BAR
88	GAS PISTON SPRING
89	GAS PISTON
90	RUBBER GAS RING
91	EXTRACTOR SPRING
93	LOCKING BLOCK

## **Limited Warranty Information**

There is a factory registration card included in the box with your shotgun. Please fill this out when you purchase the shotgun and mail it to us. We will need this card completed in order to help you with possible future warranty work.

**For warranty work, please call 321-636-3377 to discuss your repair needs with one of our representatives.** If warranty work is approved, you will be given a return address to send back the firearm for repairs. Make sure you include your return address and a contact phone number, along with your sales receipt and a short description of the problem with the shotgun. You will be required to pay for freight to our facility.

This Iver Johnson Arms, Inc. shotgun is warranted only to the original retail customer for one year from date of purchase. It is warranted against defects in material and workmanship. All parts and labor are covered by Iver Johnson Arms at our option. Shipping of the firearm to our repair facility must be paid for by you, the customer. We will pay for return shipping of the firearm to the customer, under this one year limited warranty. Damage caused by failure to perform normal maintenance to the firearm, damage caused by the use of reloaded, high velocity, high pressure, or other non-standard ammunition, or any other unauthorized repair, modification, abuse, or alteration to the firearm is NOT covered by this Limited Warranty and the warranty is void. There will be a charge for labor and parts related to repairs which are not covered under this warranty, and shipping to and from our facility will be charged to you, the customer.

The wood on the stock and forend is not covered under this one year limited warranty. The warranty on the wood stock is 60 days and is limited to the original retail customer, extending 60 days from the date of retail purchase and covers only manufacturer and material defects.

Transportation to our repair facilities, government fees, damage caused by failure to perform normal maintenance, sales outside the United States, damage caused by use of high velocity, high pressure, reloaded or other nonstandard ammunition, or by any



unauthorized repair, modification, misuse, abuse or alteration of the shotgun is not covered by this Limited Warranty.

You will need to enclose a copy of your retail purchase sales receipt with your firearm when you ship it to us. This will be required to prove date of purchase and determine if you qualify for warranty work.



**NOTICE:** It is illegal to ship any firearm with ammunition in the firearm or in the same package. Be sure your firearm, and the package it is in, is empty of all ammunition before shipping.

**Manufacturer:**

Armed Guns  
Izmir/Turkey

**Importer:**

Iver Johnson Arms, Inc.  
PO Box 561294  
Rockledge, FL 32956  
Phone: 321-636-3377 Fax: 321-632-7745  
[www.iverjohnsonarms.com](http://www.iverjohnsonarms.com)

## **WARNING**

Children are attracted to and can operate firearms that can cause severe injuries or death. Prevent child access by always keeping guns locked away and unloaded when not in use, with ammunition stored separately. If you keep a loaded firearm where a child obtains and improperly uses it, you may be fined or sent to prison.

## **ADVERTENCIA**

A los niños les atraen las armas de fuego y los pueden hacer funcionar. Ellos pueden causarse lesiones graves y la muerte. Evite que los niños tengan acceso a las armas de fuego guardándolas siempre con llave y descargadas cuando no las esté utilizando. Si usted tiene un arma de fuego cargada en un lugar en que un niño tiene acceso a ella y la usa indebidamente, le pueden dar una multa o enviarlo a la cárcel.