



Churchill

INSTRUCTIONS MANUAL

Models 512-520-528-536

READ THE INSTRUCTIONS AND WARNINGS IN THIS MANUAL CAREFULLY BEFORE USING THIS FIREARM

FIREARMS SAFETY

We believe that safe firearms handling is the most important consideration for anyone who uses firearms and ammunition. Please take a few minutes to thoroughly read and understand this instruction manual included with this shotgun.

CAUTION

FIREARMS SAFETY DEPENDS ON YOU!

- Don't rely on your gun's safety. Treat every gun as if were loaded and ready to fire.
- Never cross a fence, climb a tree or jump a ditch with a loaded gun.
- Never load or carry a loaded gun until you intend to use it.
- Watch your muzzle so the other fellow doesn't have to.
- Keep guns and ammunition separately and in locked storage.
- Don't shoot unless absolutely sure of your target and what is beyond it.
- Know the range of your gun.
- Always wear eye and ear protection when shooting.
- Always be sure the barrel is free of obstructions, and only carry ammunition specifically intended for the gun you are using.
- Do not alter or modify your gun. Have your gun regularly checked by a gunsmith.

THIS MANUAL CONTAINS

SAFE GUN HANDLING IS YOUR PERSONAL RESPONSIBILITY AT ALL TIMES. Disregarding warnings in this manual may result in injury or death to you and others and damage to property.

1. Important warnings that should be read and understood before using this firearm.
2. Directions and procedures for handling, loading, firing and unloading.
3. Instructions for care, cleaning, repair, and service of this shotgun.

This instruction and safety manual is designed to help you in learning how to properly use and care for your shotgun. Only when you are certain you have fully familiarized yourself with the function of your firearm should you practice loading, unloading and firing with live rounds of ammunition.

This instruction manual should always accompany this firearm and be transferred with it upon change of ownership. Should you ever need to replace it, this manual is available FREE upon request.

DISCLAIMER OF LIABILITY

We shall not be responsible for product malfunctioning or for physical injury, death or damage to property resulting from either intentional or accidental discharge of this firearm, its criminal or negligent use, improper or careless handling, unauthorized modifications or alteration, use of defective or improper or hand-loaded or (replaced) ammunition, or from its use for purposes or subject to treatment for which it was not designed. For your safety, use only original high quality commercially manufactured ammunition in good condition that is appropriate to the caliber / gauge of your gun. We shall not be responsible for products or results from use of defective, improper or reloaded ammunition.

WARNING - LEAD EXPOSURE

Discharging firearms in poorly ventilated areas, cleaning firearms, or handling ammunition may result in exposure to lead and other substances that may cause birth defects, reproductive harms, and other serious physical injuries. Have adequate ventilation at all times. Wash your hands thoroughly after exposure. Shooting or cleaning guns may expose you to lead.

WARNING

Prior to removing this gun from its packaging and prior to loading and firing, carefully and thoroughly read the entire instruction manual which gives advice on the gun's proper handling and functioning. Your safety and that of others (including your family) depends on your responsible compliance with that advice. If unfamiliar with firearms, seek supervised instruction.

FIREARMS SAFETY IS YOUR RESPONSIBILITY.

GENERAL SAFETY WARNINGS

1. Careless and improper handling of this gun could result in unintended discharge causing injury, death or property damage. Safety must be the first and constant consideration when handling a firearm and ammunition.
2. This shotgun was designed to function properly in its original condition. Alterations can make it unsafe. Do not alter any part or add or replace parts.
3. Shotguns should only be carried with the action open and chamber empty to prevent accidental discharge.
4. Always handle and treat your gun as if it were loaded so you never fire it accidentally when you think it is unloaded. Never take anyone's word it is unloaded. Always check it yourself with your fingers off the trigger and the gun pointed in a safe direction.
5. Never place your finger inside the trigger guard unless you intend to fire.
6. Water, snow, mud, excessive lubricating oil or grease or any other material can obstruct the barrel of your gun. Always check the barrels of your firearm for obstruction before loading and firing. Clean a fouled gun immediately to ensure its correct and safe function.
7. Keep the gun's muzzle pointed in a safe direction at all times. Never let the muzzle of a firearm point at any part of your body, another person or at anything you do not intend to shoot. Always be certain of your target before firing.
8. UNLOAD ALL FIREARMS WHEN NOT IN USE. NEVER STORE A LOADED FIREARM. Firearms and ammunition should be safely stored separately so that they are inaccessible to children or unauthorized users.
9. Always make sure your gun is not loaded before cleaning, storing, or handing it to another person.

10. Always wear safety glasses while shooting to protect your eyes from injury by gun powder, gas, lubricant, dirt or metallic particles, carbon residue, sparks or other debris.
11. Always wear ear protection when shooting, especially on a range. Without ear protection the noise from your gun and other guns close to you, could leave a "ringing" in the ears for some time after firing. Repeated exposure to shooting noise could result in permanent hearing loss.
12. Never climb a tree, fence or wall while carrying a loaded firearm.
13. Don't shoot at a hard surface or water. A ricochet may travel in unpredictable directions to strike you or an object you cannot see.

14. Firearms and alcohol do not mix. Never drink alcoholic beverages or take drugs before or during shooting, as this constitutes criminal disregard for your safety and that of others. Never use a gun while you are taking medication unless you have checked with your doctor to ensure your fitness to handle your gun safely.

15. If you have any doubts about your ability to handle or use this shotgun safely, seek supervised instruction.

16. Horseplay has no place around firearms. Guns can't think - you can!

17. Remember, safety is your responsibility. Be a safe shooter.

18. FOLLOW THE LAW: Obey all local, state and federal laws regarding storage, shooting and transporting your firearm.

NOMENCLATURE

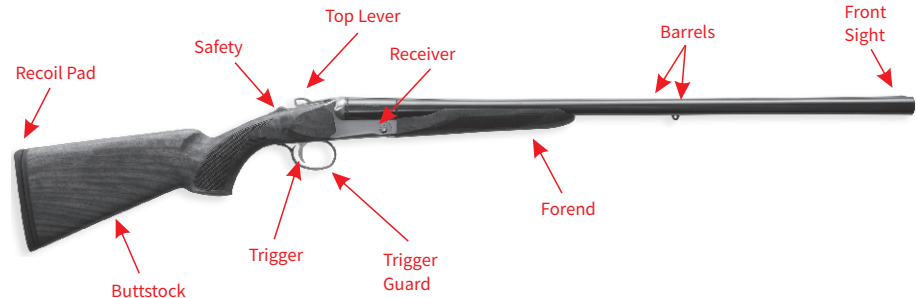

DIRECTIONS FOR ASSEMBLY

WARNING: READ AND UNDERSTAND ALL INSTRUCTIONS AND WARNINGS IN THIS MANUAL BEFORE USING THIS SHOTGUN. It is important to learn the parts of your shotgun and their functions before using this firearm.

Before assembling the shotgun, make sure there are no shot shells in the chambers.

1. Remove the forend from the barrel by pulling the forend release lever (Fig.1) away from the forend and pivot the forend away from the barrel (Fig.2).



Fig.1



Fig.2

2. Apply a small amount of high quality lubricant to all surfaces on both sides marked with red arrow in (Fig.3).

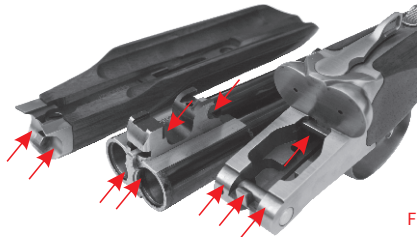

Fig.3

3. Attach barrels to the action and engaging the dual hinge pin surfaces at the forward portion of the receiver, with the hinge pin bearing notches on each side of the barrel. Hold the barrels with the muzzle at a downward angle with respect to the receiver. Once the bearings are properly seated, lift up on the barrels and close the action (Fig.4).



Fig.4

4. When the barrels are closed properly against the receiver, the Top Lever will position at the center of the action (Fig.5).



Fig.5

5. Attach the forend to the barrels by placing the metal part of the forend assembly against the receiver. Pivot forend toward the barrel to the closed and locked position against the barrels (Fig.6).

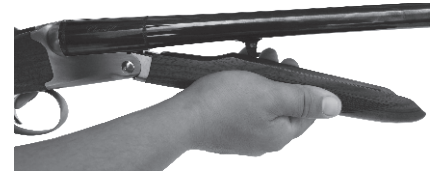

Fig.6

OPERATING INSTRUCTIONS

WARNING: READ AND UNDERSTAND ALL INSTRUCTIONS AND WARNINGS IN THIS MANUAL BEFORE USING THIS SHOTGUN. IT IS IMPORTANT TO LEARN THE PARTS OF YOUR SHOTGUN AND THEIR FUNCTIONS BEFORE USING THIS FIREARM.

TOP LEVER

The Top Lever controls the locking of the breech of the barrels to the receiver. To open the gun, move the Top Lever to its extreme right hand position and ease down the barrels. The Top Lever will then automatically return toward the center position while barrels are open (Fig.5).

SAFETY / BARREL SELECTOR

Safety is first and foremost when handling any firearm. To engage the safety, slide the Safety Button fully rearward. There is a visible "S" to help guide you. To disengage the safety in order to fire the shotgun, slide the Safety Button fully forward. Always keep the safety in the "Safe" position until you are ready to fire the shotgun.

Your shotgun is equipped with only a manual safety which requires the Safety Button to be manually moved rearward to the “Safe” position to engage the safety from the fire position.

WARNING: YOUR SHOTGUN IS EQUIPPED WITH A MANUAL SAFETY ONLY!

On your shotgun, the barrel selector is placed on the safety. You can select which barrel will fire first by sliding the Selector to either the right or left. With the Selector Button moved to right, the right barrel will fire first (Fig.7a). When the Selector Button is moved to the left position, the left barrel will fire first (Fig.7b).

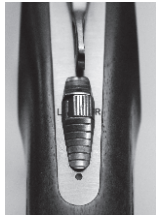

Fig.7a

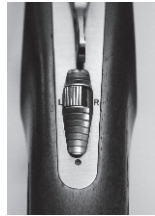

Fig.7b

EXTRACTOR

Your shotgun is equipped with manual extractors. When you open the breech of the shotgun, it will partially extract the shells for easy removal by hand (Fig.8).



Fig.8

MULTI CHOKE TUBES

Your shotgun is equipped with interchangeable multi choke tubes. The notches on the top of the tube can identify the choke tube (Fig.9).

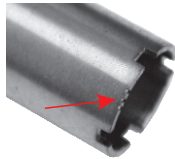

Fig.9

Multi-Choke Tube Markings and Constrictions

Name	Constriction		Notches	Markings
	Inch	mm		
Cylinder	.000"	0.00		C
Skeet	.005"	0.13		S
Improved Cylinder	.010"	0.25		IC
Modified	.020"	0.51		M
Improved Modified	.025"	0.64		IM
Full	.035"	0.89		F

WARNING: PERIODICALLY CHECK TO BE SURE THE CHOKE TUBES ARE TIGHT & PROPERLY SEATED.

Before changing a choke tube, always make sure that your shotgun is unloaded and the safety is in the “Safe” position. To change the choke tubes, use the choke tube wrench. The wrench and additional chokes are supplied in the shotgun box. Insert the wrench into the recessed space of the tube and unscrew counterclockwise. Insert the desired choke tube and seat with the wrench in the clockwise direction (Fig.10).

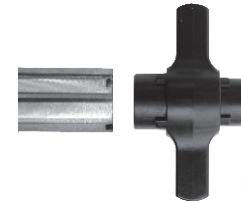

Fig.10

WARNING: NEVER FIRE YOUR SHOTGUN WITHOUT A CHOKE TUBE INSTALLED. This could damage the choke tube threads on the inside of the barrels.

AMMUNITION

Use only high quality factory ammunition specifically designed for your gauge of shotgun. The gauge and chamber are marked on barrel. The shells that can be used for each gauge are listed at below table. We do not recommend using slugs with choke tubes tighter than improved cylinder.

WARNING: STEEL SHOT USAGE

Your shotgun will accommodate steel shot. However steel shot (up to and including shot size #2) should not be fired through your shotgun with a choke tighter than modified. If shot larger than #2 is used, the tightest choke used should be an improved cylinder. Do not use steel shot with improved modified, full or extra full choke tubes (flush mount or external).

WARNING: ACCIDENTAL LOADING AND DISCHARGE OF SHELLS OF THE WRONG GAUGE IN YOUR GUN CAN RESULT IN DAMAGE TO YOUR GUN AND INJURY TO THE SHOOTER OR OTHERS.

Only carry the proper ammunition with you when shooting.

LOADING

WARNING: READ AND UNDERSTAND ALL INSTRUCTIONS AND WARNINGS IN THIS MANUAL BEFORE USING THIS SHOTGUN.

It is important to learn the parts of your shotgun and their functions before using this firearm. Be sure of your target and what's beyond before firing.

To load your shotgun, be sure the safety is in the "Safe" position, open the action by moving the top lever to the right. This will cause the lock to disengage and allow the barrels to pivot downward exposing the chambers. Insert shotshells of the appropriate gauge and size into the chambers (Fig.11). When you are finished loading the chambers, close the breech by pivoting the barrels against the action.



Fig.11

FIRING

After you have inserted the shotshells into the chambers and have closed and locked the breech, your shotgun is ready to fire. Disengage the safety by pushing the safety button fully forward. Pull the trigger and the barrel will fire in the order of right-left. After firing, allow the trigger to return to the fully forward position before firing again. Always keep the shotgun pointed in a safe direction and the safety in the "safe" position.

WARNING: READ AND COMPLETELY UNDERSTAND ALL INSTRUCTIONS AND WARNINGS IN THIS MANUAL BEFORE USING THIS SHOTGUN.

UNLOADING

Before unloading, check to assure that the safety is in the "Safe" position. Open the action by pushing the top lever all the way to the right and pulling the barrels fully downward.

Your shotgun is equipped with manual extractors. When you open the breech of the shotgun, they will partially extract the shells for easy removal by hand.

Gauge & Chamber	Shells can be used
12/76 12Ga 3"	12/70 12Ga 2 3/4" 12/76 12Ga 3"
12/89 12Ga 3 1/2"	12/70 12Ga 2 3/4" 12/76 12Ga 3" 12/89 12Ga 3 1/2"
20/76 20Ga 3"	20/70 20Ga 2 3/4" 20/76 20Ga 3"
28/70 28Ga 2 3/4"	28/70 28Ga 2 3/4"
410/76 410cal 3"	410/70 410cal 2 3/4" 410/76 410cal 3"

Do not use a cartridge that is longer than the maximum cartridge length that is stamped on the barrel.

DISASSEMBLY

WARNING: READ AND FULLY UNDERSTAND ALL INSTRUCTIONS AND WARNINGS IN THIS MANUAL BEFORE USING THIS SHOTGUN.

Disassemble, clean and oil your shotgun at regular intervals or when it has been exposed to sand, water or other adverse conditions.

To disassemble your shotgun:

1. Remove the forend by pulling the forend release lever away from the forend, and pivoting the forend away from the barrel.
2. Push the top lever to the right to disengage the action.
3. Remove the barrel assembly.

Further disassembly is not recommended and not necessary for regular maintenance (Fig.12).



Fig.12

CAUTION

Always unload your gun and store it and ammunition separately in locked receptacles out of children's reach and sight, minimizing the risk that the gun and ammunition could be easily available for loading and firing.

USE YOUR SHOTGUN CAREFULLY AND SAFELY.

SERVICE INSTRUCTIONS

If your shotgun does require service, contact our local service department by e-mail, letter, fax or telephone. If you should ever have to send your shotgun back for repair please follow these instructions:

- a) Make absolutely certain it is unloaded;
- b) Do not send ammunition with your shotgun;
- c) Remove any accessories;
- d) Please package the gun securely (be certain gun parts can not shift during shipment) in a suitable shipping container;
- e) Please include, with your firearm, a clear description of the problem and service you wish us to perform;
- f) Please give us a clear ship-to address, (no P.O. Box numbers) your daytime phone number and if possible a fax number and email address;
- g) Please place your correspondence inside the package;
- h) If you have any questions, please contact the service department, at;

NOTE

NOTE

NOTE

MODELS 512 - 520 - 528 - 536 SIDE BY SIDE SHOTGUN PART DIAGRAM

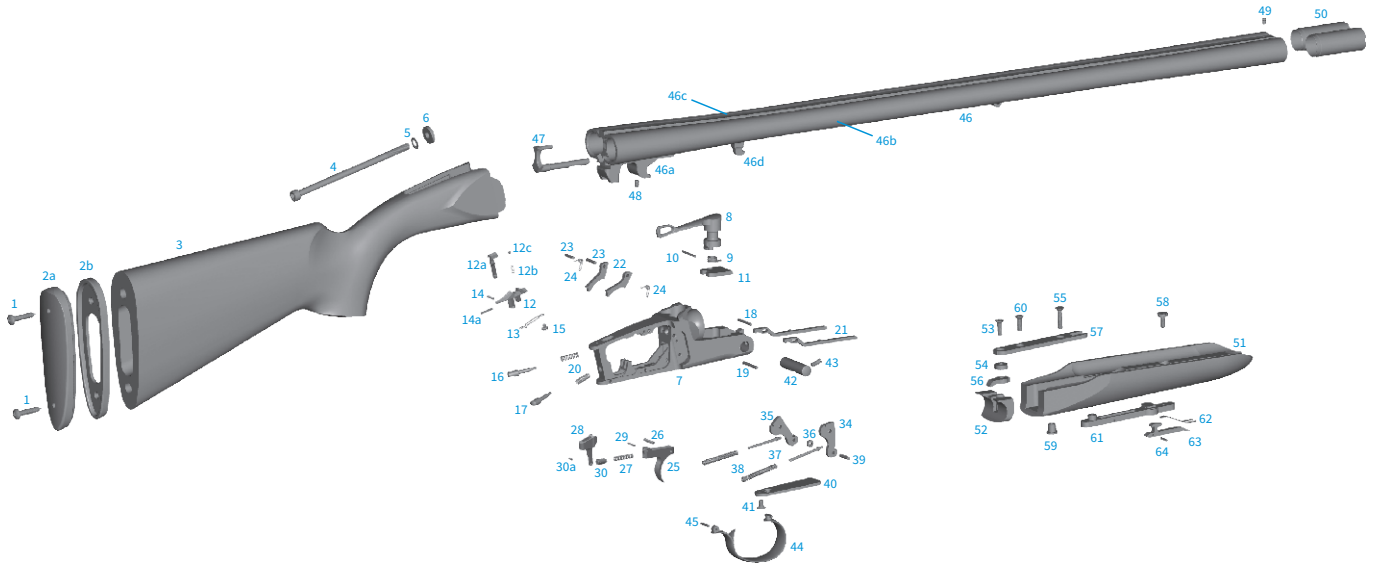

MODELS 512 - 520 - 528 - 536 SIDE BY SIDE SHOTGUN PART LIST

STOCK GROUP

- 1 Recoil Pad Screw(x2)
- 2a Recoil Pad
- 2b Recoil Pad Base
- 3 Stock
- 4 Stock Bolt
- 5 Stock Bolt Lock Washer
- 6 Stock Bolt Washer

RECEIVER GROUP

- 7 Receiver
- 8 Top Lever
- 9 Top Lever Spring
- 10 Top Lever Pin
- 11 Locking Plate
- 12 Safety
- 12a Selector
- 12b Selector Spring
- 12c Selector Ball
- 13 Safety Spring
- 14 Safety Spring Pin
- 14a Safety Pin
- 15 Safety Spring Screw
- 16 Firing Pin Right
- 17 Firing Pin Left

- 18 Hammer Cocking Rod Pin
- 19 Firing Pin Retainer
- 20 Firing Pin Spring (x2)
- 21 Hammer Cocking Rod (x2)
- 22 Sear (x2)
- 23 Sear Pin (x2)
- 24 Sear Spring (x2)
- 25 Trigger
- 26 Trigger Pin
- 27 Trigger Spring
- 28 Trigger Sear Catch
- 29 Trigger Sear Catch Pin
- 30 Trigger Sear Catch Plunger
- 30a Trigger Sear Catch Plunger Pin
- 34 Hammer Right
- 35 Hammer Left
- 36 Hammer Spacer
- 37 Hammer Spring Guide Rod (x2)
- 38 Hammer Spring (x2)
- 39 Hammer Pin
- 40 Bottom Plate
- 41 Bottom Plate Screw
- 42 Receiver Main Pin
- 43 Receiver Main Pin Stop Screw
- 44 Trigger Guard
- 45 Trigger Guard Pin

BARREL GROUP

- 46 Barrel Assembly
- 46a Barrel Mono Block
- 46b Barrel Tube (x2)
- 46c Top Ventilated Rib
- 46d Forend Locking Latch
- 47 Extractor
- 48 Extractor Stop Screw
- 49 Front Sight
- 50 Choke Tube (x2)

FOREND GROUP

- 51 Forend
- 52 Iron Hook
- 53 Iron Hook Screw
- 54 Iron Hook Washer
- 55 Forend Screw Front
- 56 Lever Plate
- 57 Lever Plate Lug
- 58 Forend Plate Screw
- 59 Lever Plate Bushing
- 60 Lever Plate Bushing Screw
- 61 Forend Plate
- 62 Forend Catch Spring
- 63 Forend Catch
- 64 Forend Catch Pin



Importer:

European American Armory Corporation

EAA Corp

www.eaacorp.com

Email: eaacorp@eaacorp.com

1426 King Street

Cocoa, FL 32922

Phone: (321) 639-4842



AKKAR SİLAH SANAYİ LTD

ORHANLI MH ANIT SK 21 TUZLA 34956 İSTANBUL TURKEY

P +90 216 394 43 64 **F** +90 216 394 43 73

AKKAR@AKKAR.COM.TR WWW.AKKAR.COM.TR



//AKKARSILAH



@AKKARSILAH



//AKKARSILAH