



ARMALITE®

ARMALITE®, INC
OWNER'S MANUAL
FOR
AR-10A & AR-10B SUPERSASS™



 **READ THIS MANUAL THOROUGHLY, PARTICULARLY THE WARNINGS, BEFORE USING THIS FIREARM! IT'S IMPORTANT!**

©2011 ArmaLite®, Inc., All rights reserved.
August 2013 Rev 24
P/N: MANUAL AR10 SS

ArmaLite®, Inc.
525 E. Pinnacle Peak Rd #100
Phoenix AZ. USA 85024
623-780-1050
www.ArmaLite.com



Congratulations on buying an ArmaLite! You won't be disappointed.

Our many ArmaLite-made parts and accessories for your gun are shown on our website www.armalite.com. You can also check our web specials for great deals or browse through our on-line catalog.

Check with your local ArmaLite dealer for any special deals or sales that he may be running.

To learn more about your new firearm, we invite you to visit the Library on our website. There, we have on-line Manuals, Frequently Asked Questions and Technical Notes you're sure to find helpful.

There's nothing better than adding to your ArmaLite firearm with GENUINE ArmaLite parts!

525 E. PINNACLE RD. #100 623-780-1050 info@sacfirearms.com
FOLLOW ARMALITE ON FACEBOOK AND TWITTER



1. READ THIS FIRST!

Throughout this manual you will find **WARNINGS** and/or **CAUTIONS** printed in bold print. All **WARNINGS** and **CAUTIONS** should be read carefully and followed completely. **WARNINGS** discuss issues that could result in damage to your firearm, or injury or death to you or a bystander. **CAUTIONS** discuss issues that could result in damage or malfunction of your firearm.



WARNING: IT IS YOUR RESPONSIBILITY TO ASSURE THAT YOUR FIREARM IS HANDLED, FIRED, AND STORED SAFELY AND RESPONSIBLY AT ALL TIMES.

This manual provides instructions on the operation and maintenance of your ArmaLite® firearm. Read and understand it carefully before you try to use your firearm. Your safety, and that of those around you, depends on your knowledge of your firearm and on your knowledge of safety rules common to all firearms. Please study the common-sense safety rules noted in this manual. Your first responsibility as a gun owner is always safety!

Your second responsibility as a gun owner is security. Make sure that your firearm remains in responsible hands...YOURS! Don't become an unwitting partner in a crime or tragedy: make sure your firearm is properly secured. Lock it in a secure storage container or, if none is available, remove key functional components and store them separately. If you have more than one similar firearm, make sure that you specifically identify the removed assembly with its original firearm because the assemblies may not be interchangeable.

It is also your responsibility to assure that you comply with all federal, state, and local laws with regard to the purchase, ownership, use, and storage of your firearm.

NOTICE: THIS MANUAL MAY COVER NUMEROUS MODELS AND/OR CALIBERS OF OUR FIREARMS. THE TEXT, PICTURES, AND EXPLODED VIEWS DO NOT NECESSARILY DEPICT ALL MODEL VARIATIONS. YOU MAY NEED TO CONTACT US FOR INFORMATION ON PARTS THAT ARE UNIQUE TO YOUR MODEL.

NOTICE

ArmaLite® has no control over the use of your firearm, and shall not be responsible for injury, death, or damage to property resulting from either intentional or accidental discharge of this firearm. In addition, ArmaLite® shall not be responsible for proper function of the firearm when it is used for purposes or subjected to treatment for which it was not intended. ArmaLite® will not honor claims which may result from careless or improper handling, unauthorized adjustments or parts replacement, corrosion, neglect, use of the wrong type or caliber of ammunition, or the use of ammunition other than original, high quality commercially manufactured ammunition in good condition or any combination thereof.

2. SAFETY FIRST! IT'S YOUR RESPONSIBILITY!

- * **Treat every gun as if it is loaded ...AT ALL TIMES!**
- * **Always keep the muzzle pointed in a safe direction.**
- * **Never point your firearm at anything that you do not intend to shoot.**
- * **Keep your finger off the trigger and out of the trigger guard until you are aiming at your target and ready to shoot.**
- * **Always keep the safety in the "SAFE" position, especially when the firearm is loaded and cocked, until you are ready to fire.**
- * **Always keep and carry your firearm with an empty chamber until you intend to shoot, so that your firearm cannot be fired unintentionally. Firearms should be unloaded when not actually in use.**
- * **Be sure of your target and backstop before you shoot. As yourself what your bullet will hit if it misses or goes through the target.**
- * **Never shoot at hard, flat surfaces or water...bullets can ricochet.**
- * **Always wear hearing and eye protection when shooting.**
- * **Discharging firearms in poorly ventilated areas, cleaning firearms, or handling ammunition may result in exposure to lead, a substance known to be associated with birth defects, reproductive harm, and other serious injury. Have adequate ventilation at all times and wash hands after handling.**
- * **Be sure that your barrel is clear of obstructions, including excessive oil, grease, cleaning patches, etc before shooting.**
- * **Use only clean, high quality factory loaded ammunition in good condition. ArmaLite® cannot condone the use of handloaded ammunition. Any such use voids the ArmaLite® warranty.**
- * **Do not alter or modify your firearm.**
- * **Do not try to change your firearm's trigger pull, because alterations of trigger pull can affect sear engagement and might cause accidental firing.**
- * **Store firearms and ammunition separately, and beyond children's reach.**

IN CASE OF MALFUNCTION, STOP! REVIEW THIS MANUAL TO IDENTIFY AND RESOLVE THE PROBLEM. IF YOU CANNOT RESOLVE IT, CONTACT ARMALITE®.

KEEP THIS MANUAL WITH YOUR RIFLE. IF YOU SELL THE RIFLE, GIVE THIS MANUAL TO THE NEW OWNER.

3. TABLE OF CONTENTS

1. READ THIS FIRST!	4
2. SAFETY FIRST! IT'S YOUR RESPONSIBILITY!	5
3. TABLE OF CONTENTS	6
4. SAFE STORAGE	7
5. GENERAL INFORMATION	8
6. EXPLODED DRAWINGS AND PARTS LISTS	11
7. AMMUNITION	19
8. INITIAL ASSEMBLY, INSPECTION, AND CLEANING	20
9. LOADING AND FIRING	27
10. CLEARING / UNLOADING THE FIREARM	32
11. ZEROING THE SIGHTS	33
12. DISASSEMBLY	34
13. MAINTENANCE	41
14. REASSEMBLY	53
15. TROUBLESHOOTING	60
16. WARRANTY, SERVICE, AND SUGGESTIONS	64

4. SAFE STORAGE

 **WARNING: ALWAYS ASSURE THAT YOUR FIREARM IS COMPLETELY UNLOADED BEFORE STORING IT. ALWAYS TREAT YOUR FIREARM AS IF IT WERE LOADED. ALWAYS STORE YOUR FIREARM IN A SAFE LOCATION, SEPARATE FROM THE AMMUNITION.**

Make certain that both the chamber and magazine of your rifle are unloaded before you store it. Store your rifle in a securely locked gun safe. If you do not have a safe, remove the bolt and bolt carrier assembly from your rifle, and store it separately from the rifle in a secure location. Store your ammunition separately from the rifle and from the bolt and bolt carrier assembly.

 **WARNING: IF YOU HAVE MORE THAN ONE SIMILAR FIREARM, MAKE SURE THAT YOU SPECIFICALLY IDENTIFY THE REMOVED ASSEMBLY WITH ITS ORIGINAL FIREARM BECAUSE THE ASSEMBLIES MAY NOT BE INTERCHANGEABLE.**

5. GENERAL INFORMATION

Your rifle is a lightweight, gas operated, air cooled, magazine fed semiautomatic rifle produced for a high degree of accuracy, reliability, and durability. The rifle's construction features extensive use of aircraft-grade forgings, with no die-cast or extruded parts employed in the receivers. The patented bolt assembly provides higher strength than that found on similar designs.

⚠ WARNING: YOUR ARMALITE® FIREARM WAS DESIGNED TO FUNCTION PROPERLY WITH ITS ORIGINAL COMPONENTS. ALTERATIONS TO ITS ORIGINAL COMPONENTS OR REPLACEMENT OF THEM WITH AFTERMARKET (NON-ARMALITE®) COMPONENTS CAN CAUSE MALFUNCTIONS OR EVEN MAKE THE FIREARM UNSAFE. DO NOT ALTER ANY PART OR ADD / SUBSTITUTE PARTS NOT MANUFACTURED BY ARMALITE® INC.

Although the SuperSASS™ looks very much like an M16 series rifle, it actually employs only a small number of M16 parts because few M16 parts are strong enough for a 7.62mm firearm. The similar design allows the operator to operate and maintain it the same way he operates and maintains the M16 rifle, while employing almost all of the same cleaning tools, cleaning solutions, and lubricants.



SuperSASS™ with Suppressor broken down in transit chest
(Shown with optional accessories. The basic system is supplied with one 10 and one 20 round magazine)

5.1 AR-10A VERSUS THE AR-10B

The AR-10A family of ArmaLite® firearms is functionally identical to our AR-10B family. Operation, controls, and maintenance are the same. However, the AR-10A family is designed to accept early ArmaLite AR-10 “Waffle” magazines and good quality magazines copied from them, instead of ArmaLite’s proprietary steel magazines that are used in our AR-10B family. Neither family of firearms will function correctly with the other family’s magazines.

The AR-10B magazine is based on the magazine of the famed M-14 rifle. This magazine was adopted during the period of the “Assault Weapons Ban”, during which new Waffle magazines couldn’t be legally produced. The AR-10B magazine has proven to be as supremely successful in the AR-10B as its predecessor was in the M-14, and ArmaLite will continue to offer it.

We have tested, we recommend, and we ship polymer Magpul PMAG® 20LR magazines with our AR-10As. Other similar derivative magazines such as the KAC, M110, and DPMS / Remington 19 round magazines may fit and may function, but we have not tested them so we can’t assess their reliability. You can purchase extra PMAG@s from our website.

Physical differences between the “Waffle magazine and the M-14 style magazine necessitate differences in some components used in AR-10As as compared to similar components in the AR-10Bs. Some components of our AR-10A firearms are unique to that family. For example, the AR-10A Bolt Stop, Magazine Catch, Upper Receiver, and Lower Receiver are not the same as those in our AR-10Bs. This Tech Note will explain the physical differences among those components.

If you need parts for your AR-10A, you may want to contact us to assure that you are purchasing the correct parts.

5.2 THE NATIONAL MATCH TRIGGER

ArmaLite®’s National Match trigger is designed to aid accuracy by reducing the distraction of the long, heavy, irregular trigger pull of the standard trigger mechanism.

The National Match trigger is a two-stage trigger with distinct characteristics: a first stage, which is relatively light, and a second stage of heavier resistance. Microscopic variations in the surface of the parts may cause a feeling of grittiness in the first stage. This is normal on factory-made parts, and will not affect the release of the shot. A properly adjusted second stage will not be creepy, and is the key to a successful mechanism.

The ArmaLite® two stage match trigger is based on that of M1/M14 rifle, and is not user adjustable. It is intentionally built with a barely detectable creep in the second stage. As the trigger breaks in with use (200 to 500 rounds) any creep tends to disappear. It is not possible to exactly predict the amount of break-in of a new trigger, so it is impossible to produce a fixed device that will always break in to produce a perfect trigger pull. If creep remains, a trained gunsmith using the same techniques used with the M1/M14 trigger system may adjust the trigger. ArmaLite® technicians will adjust the triggers for a nominal fee. Instructions will be provided to licensed gunsmiths upon request. Match triggers require more attention and tuning than standard triggers.

ArmaLite® absolutely cannot condone modification of the ArmaLite® trigger mechanism by anyone other than a trained gunsmith. Any such modification may render the device unsafe and will void the factory warranty.

5.3 BARREL LIFE

Barrel life depends on how fast the rifle is fired and how accurate the shooter insists it must be. Shooting the rifle as fast as the trigger can be pulled can ruin the barrel in just a few hundred rounds. Firing at controlled rates will allow a barrel to last for 10,000 to 15,000 rounds with accuracy acceptable for police use. Target shooters fire at very moderate rates, but their higher accuracy requirements may mean barrel replacement as early as 3,500 match rounds.

5.4 RECEIVER FIT

The SuperSASS™ is not a custom firearm. ArmaLite® requires a close fit between the receivers, but normal forging and machining variations may result in play or slight side to side receiver mismatch. This is not a manufacturing defect and has no adverse effect on accuracy.

5.5 APPEARANCE

Almost all complaints concerning appearance come from customers who forget that the SuperSASS™ is a Military Specification rifle, not a polished commercial or collectors-grade rifle. It is an industrial product, not a custom rifle, and bears finishes appropriate for its intended purposes.

ArmaLite® rifles are all thoroughly test fired before shipping. New rifles will normally show evidence of this firing. If the receiver looks light or uneven in color, it's probably just dry. A light coat of oil on the metallic surfaces will improve its appearance.

The receivers are made of forgings because forgings provide exceptional strength. By its very nature, the forging process may leave small dents and dings on the outside of the forging. ArmaLite® inspects all forgings for excessive marks, but no forging is free of them. This is not a defect.

5.6 GENERATION II MAGAZINES

Earlier versions of ArmaLite's AR-10® magazines were adapted from M-14 magazines. Those magazines incorporated a plunger in the back of the follower that had to be manually pushed in to load the magazine. The new Generation II magazines feature an integral feature on the follower that allows the magazine to be loaded without need to hold in a plunger. In other words, the new magazine loads exactly like an M-16 magazine. In addition, the feed lips and follower were redesigned to significantly improve reliability of feeding.

6. EXPLODED DRAWINGS AND PARTS LISTS

The drawings and associated parts lists in this section will give you visual references to parts discussed in the text. In the text, you will note part numbers in parentheses behind some part names. Those part numbers are the same as part numbers shown in the exploded drawings and part lists. For example, a part numbered “U-7” in the text would refer to the part numbered “7” in the Upper assembly exploded view.

SuperSASS Upper Assembly

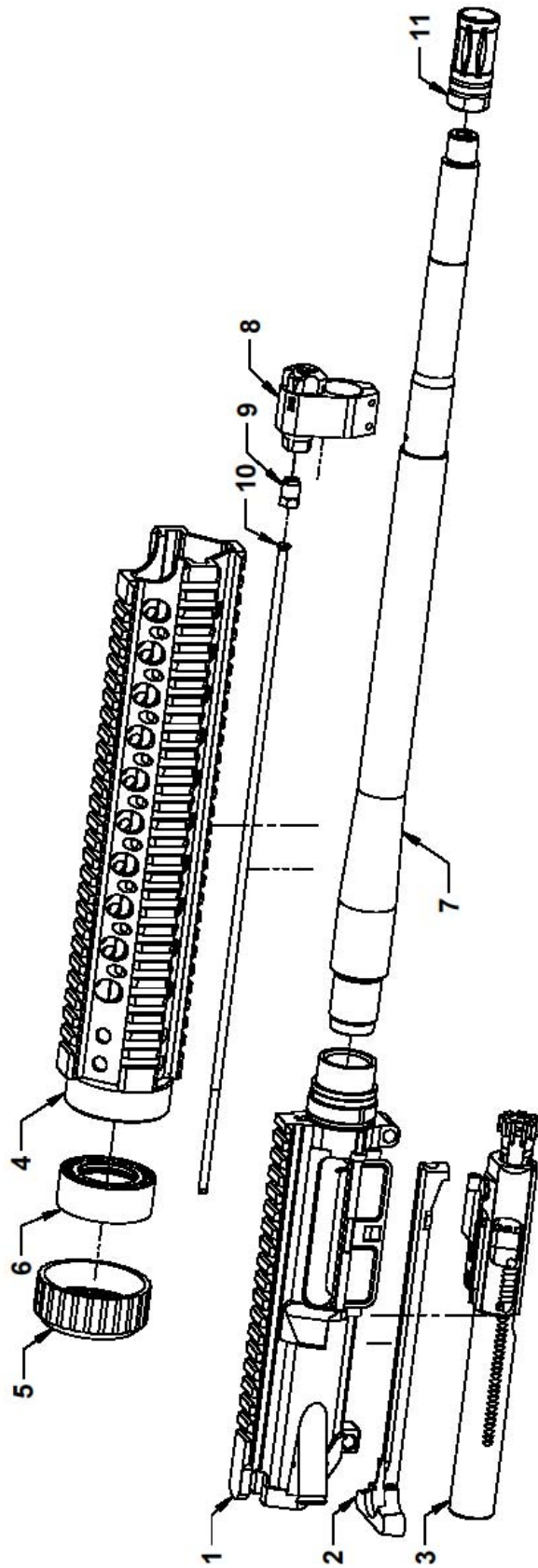

SuperSASS Upper Assembly Parts List

1	AR-10 (T) Upper Receiver Assembly	EK0040
*	AR-10A (T) Upper Receiver Assembly	A10002000
2	Gas-Buster Charging Handle Assembly	10008100
3	AR-10B Bolt Carrier Assembly	EA1085
4	Quad Rail Handguard, Free Float	10705317
5	AR-10/M15(T) Handguard Lockring	EA5030
6	AR-10(T) Barrel Nut	EA1146
7	.308 Barrel Tube, 20" "T" Rifle, SST	EA0905SF
8	Selective Gas Regulator Assembly	10109527
9	Inverted Flare Tube Nut	10109550
10	AR-10 Rifle Length Selective Gas Tube	10109545
11	AR-10 A2 Flash Suppressor	10108200

-BARREL TUBES AND BARREL EXTENSIONS ARE SOLD AS ASSEMBLIES WITH INDEX PIN

-INDEX PIN IS ALSO SOLD SEPARATELY

-IF BOLT CARRIER ASSEMBLY OR BARREL IS REPLACED, HEADSPACE NEEDS TO BE CHECKED BY QUALIFIED GUNSMITH

SuperSASS Lower Half Assembly

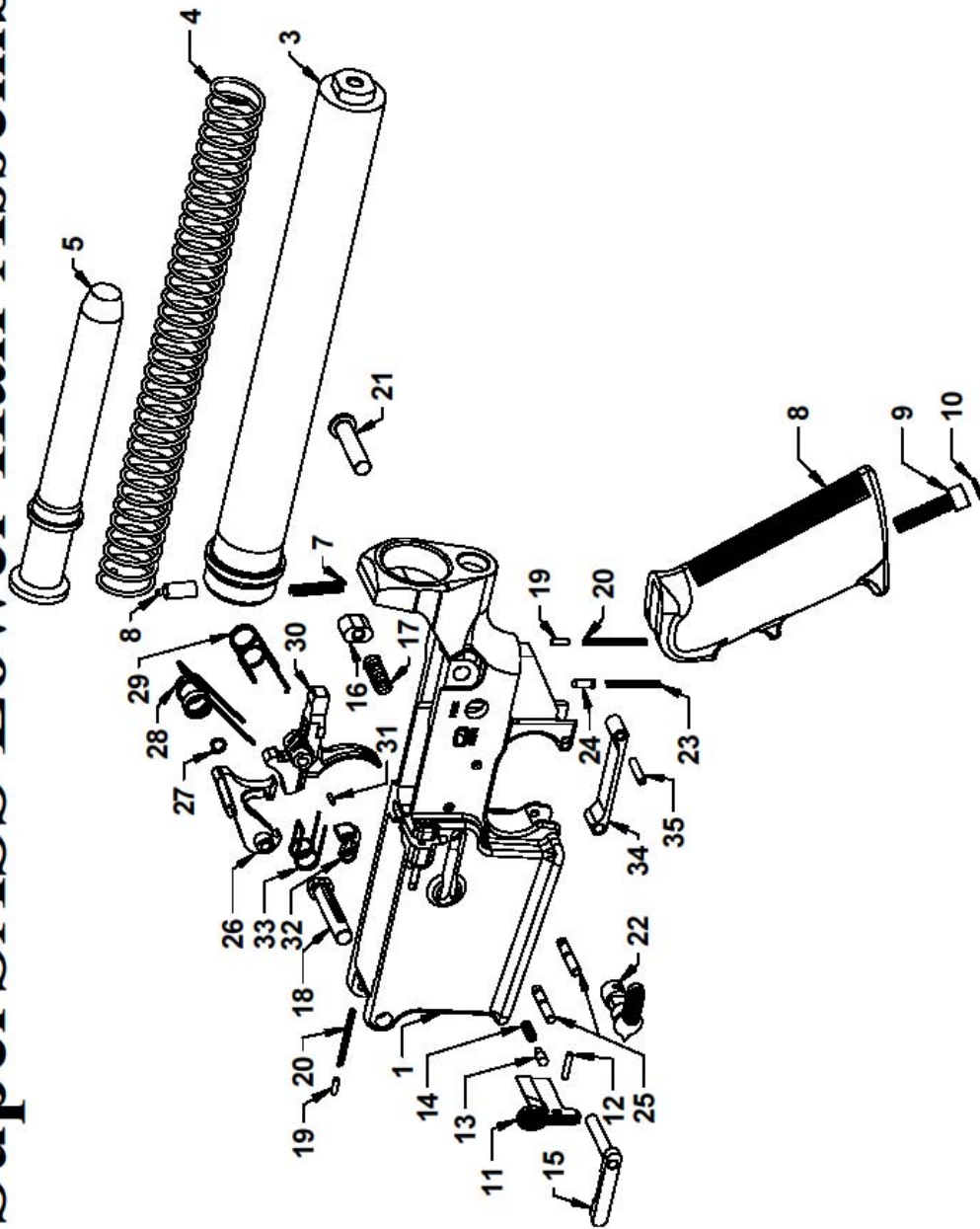

SuperSASS Lower Half Parts List

1	AR-10 (T) Lower Receiver	EA900T	17	Magazine Catch Spring	EL0280
*	AR-10A (T) Lower Receiver	EA901AT	18	AR-10B Pivot Pin	EA1112
2*	AR-10S Rifle Buttstock Assembly, Magpul PRS*	10701040	19	Detent, Takedown Pin	EL0150
3	Receiver Extension Tube	EL0370	20	Detent Spring	EL0140
4	AR-10B Operating Spring	EA1095	21	AR-10B Takedown Pin	EA1113
5	AR-10 Buffer	EA1090	22	Safety Selector	EL0290
6	Buffer Detent	EL0190	23	Ejector/Safety Spring	EB0110
7	Buffer Detent Spring	EL0200	24	Safety Detent	EL0060
8	Pistol Grip (Black)	EL0030	25	Hammer/Trigger Pin	EL0300
9	Pistol Grip Screw, SST	EL0015	26	Two Stage Tactical Hammer	10308000
10	Pistol Grip Washer	EL0020	27	Clip, Hammer Pin Retaining, "D-Ring"	10308020
11	AR-10B Bolt Stop	10203100	28	Hammer Torsion Spring	EL0320
*	AR-10A Bolt Stop	11203100	29	AR-10/M15 Hammer/Trigger Spring	15303055
12	Bolt Stop Pin, 3/32" x 1/2", Spirol Pin	EL0220	30	Two Stage Trigger	10303040
13	Bolt Stop Plunger	EL0240	31	Coiled Spring Pin, 1/16" x 1/4"	10306000
14	Bolt Stop Spring	EL0250	32	Two Stage Disconnecter	10307000
15	Magazine Catch	EA1108	33	AR-10/M15 Disconnecter Spring	10806100
*	AR-10A Magazine Catch	11203200	34	Trigger Guard Assembly	EL0380
16	Magazine Catch Button	EL0270	35	Trigger Guard Pin, 1/8" x 5/8", Spirol Pin	EL0430

-PARTS MARKED WITH AN "*" ARE NOT SHOWN
 -PARTS 26, 30, AND 32 ARE SOLD AS MATED ASSEMBLY ONLY

AR-10 BOLT CARRIER ASSEMBLY

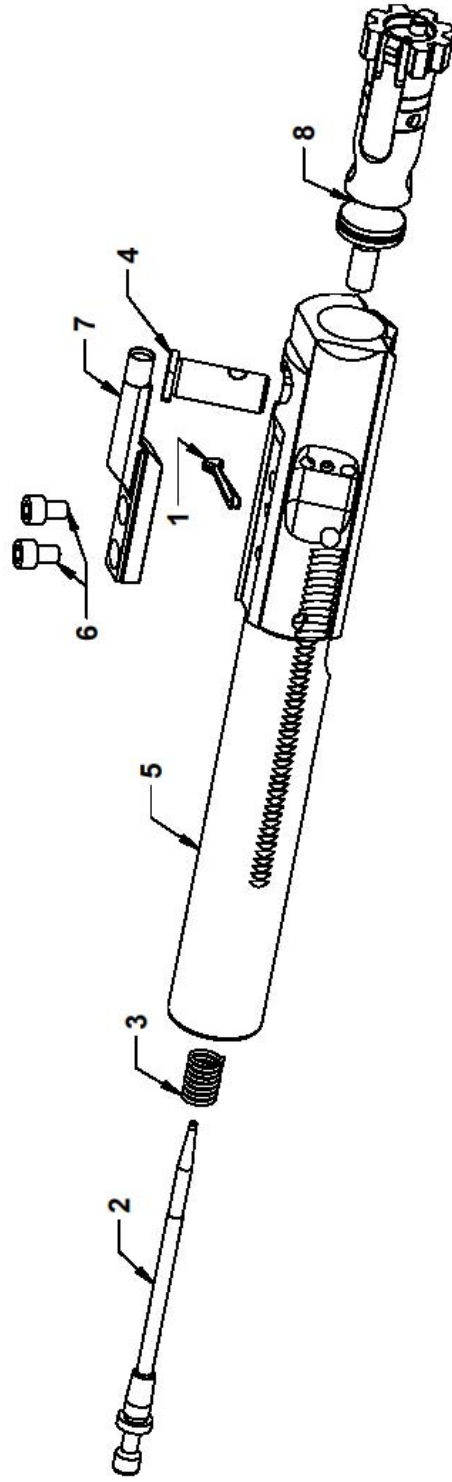

REVISION B 090618

AR-10 BOLT CARRIER PARTS LIST

1	Firing Pin Retaining Pin	EA1009
2	Firing Pin	EA1010
3	Firing Pin Spring	EA1011
4	Cam Pin	EA1015
5	Bolt Carrier	10503011
6	Key Screws	EB0140
7	Bolt Carrier Key .223/.308	EB0150
8	Bolt Assembly	EA1080

-PARTS 5, 6, AND 7 ARE NOT SOLD AS SEPARATE PIECES BUT ARE SOLD TOGETHER AS ARMALITE PART NUMBER 10502000

-PART 8 IS FACTORY REPLACEABLE ONLY SO PROPER HEADSPACE CAN BE OBTAINED

REVISION B 090618

AR-10 BOLT ASSEMBLY

1	McFarland Gas Ring	EA1055
2	Bolt	EA1060
3	Extractor Spring Insert	10403035
4	Extractor Spring	EA1030
5	O-Ring	EA1136
6	Extractor	EA1025
7	Extractor Pin	EA1020
8	Ejector Pin	EA1040
9	Ejector Spring	EA1050
10	Ejector	EA1045

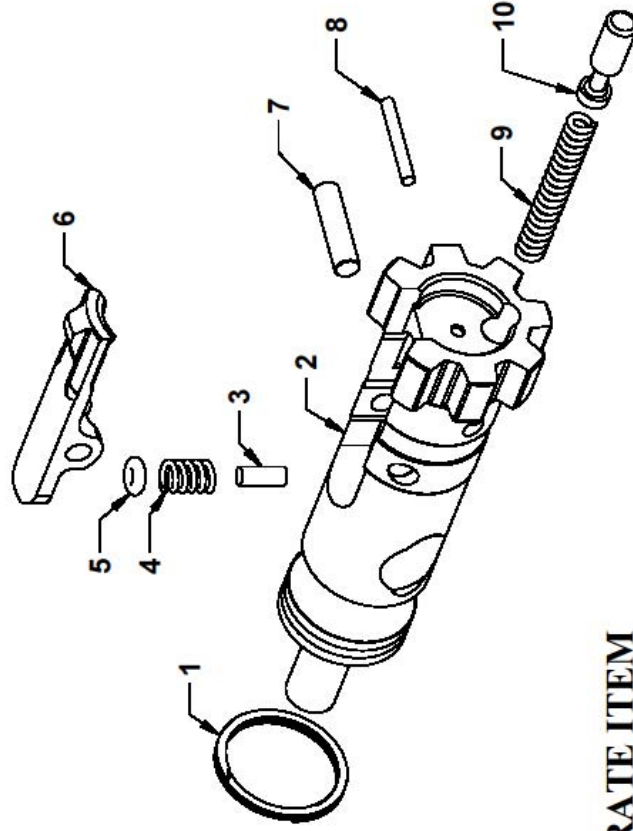

-PART NUMBER 2 IS NOT SOLD AS A SEPARATE ITEM

7. AMMUNITION

Nomenclature of cartridges can be confusing. It is vital that you understand cartridge nomenclature and only fire cartridges for which this firearm was designed. To assist you, the name of the appropriate cartridge will be etched on the receiver and/or barrel of each ArmaLite. (More information regarding cartridge nomenclature can be found in the Tech Notes on our website.)

 **WARNING: USE OF INCORRECT AMMUNITION CAN CAUSE FIREARM DAMAGE, PERSONAL INJURY, OR DEATH. MAKE ABSOLUTELY CERTAIN THAT YOU ARE USING CARTRIDGES DESIGNED FOR YOUR FIREARM. DO NOT FIRE OLD, CORRODED, DEFORMED, OR HANDLOADED AMMUNITION. IF YOU HAVE ANY QUESTIONS, CONTACT ARMALITE® BEFORE FIRING.**

Your SuperSASS™ is designed to fire all standardized U.S. military 7.62mm NATO cartridges and all factory loaded cartridges in .308 Winchester caliber (except cartridges using sabot projectiles). Do not attempt to fire any other cartridges in this firearm.

For information regarding projectile weights recommended for your particular ArmaLite, see Technical Note 110: “PROJECTILE WEIGHT VERSUS RIFLING TWIST” in the Library on our website, www.armalite.com.

 **WARNING: DO NOT FIRE SABOTED AMMUNITION IN YOUR RIFLE. THE SABOT MAY LODGE IN THE FLASH SUPPRESSOR OR SOUND SUPPRESSOR, CAUSING FIREARM DAMAGE AND POTENTIAL INJURY OR DEATH.**

Your SuperSASS™ has a specially lapped match grade barrel. It is superbly accurate when used with Black Hills, G.I. M852 or other match quality ammunition. Accuracy naturally is less impressive if lower quality ammunition is used.

 **CAUTION: FIRING TRACER AND ARMOR PIERCING AMMUNITION REDUCES BARREL LIFE.**

Firing any of the ammunition described in the above warnings will void your warranty.

NOTE: Some types/brands of ammunition have unique characteristics (e.g. extremely light or heavy projectiles, particularly soft cartridge cases, propellant that burns unusually slowly or rapidly) that reduce its reliability in any semiautomatic firearm. ArmaLite® recommends that you purchase and test a small quantity of any type of ammo in your firearm before you buy large quantities.

8. INITIAL ASSEMBLY, INSPECTION, AND CLEANING

8.1 INITIAL ASSEMBLY

8.1.1 INSTALLING AND REMOVING THE TELESCOPIC SIGHT

Optional accessories for the SuperSASS™ include a Leupold Mark 4 telescopic sight fixed to the receiver with A.R.M.S. number 22 lever lock scope rings. It is a superb optic designed to assure clear vision and accurate fire.

Clean the rail interface of the upper receiver to assure that the sight settles into its proper position. Even a small amount of dirt can cause the sights to be off.



Loosen the clamping nut on the sight ring so that the sight can be slipped over the rail in the numbered slot previously used to zero the rifle. Mounting the sight in a different slot may produce a slight shift of bullet impact.



Once the position of the sight on the upper receiver has been selected, shift the sight forward on the rail interface until the rails on the bottom of the rings stop against the front of the slot on the upper receiver to assure that the sight cannot shift forward during recoil.

If you purchased the optional Leupold scope, see its enclosed “Riflescope Owner’s Handbook” and “Ranging System for the Mil Dot Reticle” booklets for installation, use, and maintenance instructions.

⚠ WARNING: IF YOU MOUNT A SCOPE TO YOUR RIFLE, MAKE CERTAIN THAT THE SCOPE IS MOUNTED FAR ENOUGH FORWARD SO THAT IT WILL NOT IMPACT YOUR FACE DURING RECOIL. CHECK THE DISTANCE BETWEEN THE SCOPE AND YOUR FACE WHEN YOU ARE IN THE FIRING POSITION. BEAR IN MIND THAT YOUR EYE WILL BE CLOSER TO THE SCOPE WHEN SHOOTING FROM PRONE OR FROM THE BENCH THAN WHEN SHOOTING OFF-HAND. WHEN IN DOUBT, INCREASE THE EYE RELIEF.

8.1.2. ADJUSTING THE BUTTSTOCK

The adjustable buttstock is provided to allow the rifle to be adjusted to fit the operator or to accommodate winter clothing, body armor, or different firing positions. On the SuperSASS™ rifle, both the height of the cheekpiece and the length of the buttstock are easily adjustable by turning the integral knobs.



8.1.3. INSTALLING THE SOUND SUPPRESSOR

If you purchased a sound suppressor as an accessory for your SuperSASS™, you will need to install it in accordance with the manufacturer’s instructions.

⚠ WARNING: BEFORE INSTALLING OR REMOVING THE SUPPRESSOR, CONFIRM THAT THE RIFLE IS UNLOADED AND ON “SAFE”. WITH THE MUZZLE POINTED IN A SAFE DIRECTION REMOVE THE MAGAZINE, LOCK THE BOLT TO THE REAR, THEN INSPECT THE CHAMBER TO VERIFY THAT THE RIFLE IS FULLY UNLOADED.

Refer to the included suppressor manufacturer’s “Operation and Maintenance” manual for specific instructions.

8.1.4. ADJUSTING THE GAS REGULATOR TO SUIT THE SOUND SUPPRESSOR

The pressure of propellant gas built up in sound suppressors increases the cyclic rate of firearms, and can cause them to cycle so quickly that reliability and durability are reduced. The SuperSASS™ is equipped with a gas regulator assembly (U-8) with a special suppressor setting that reduces the flow of gas to the mechanism to counter this problem. Turn the knob on the selective gas regulator assembly (U-8) so that the arrow on the knob points to the letters “SUPP” when firing with the sound suppressor attached to the rifle.



For firing **without a suppressor**, turn the knob so that the arrow points to “NORM”.

⚠ CAUTION: DO NOT FIRE THE RIFLE WITH A SUPPRESSOR WHEN THE REGULATOR IS SET TO THE “NORM” SETTING. THE RIFLE WILL FUNCTION TOO FAST, AND IS SUBJECT TO UNRELIABLE OPERATION AND EXCESSIVE WEAR.

If the gas regulator is hard to turn with finger pressure alone, or is hot from firing, the rim of a **fired** cartridge case may be used as a tool.

⚠ WARNING: DO NOT USE A LIVE CARTRIDGE TO TRY TO TURN A HOT GAS REGULATOR KNOB. THE HEAT COULD DETONATE THE PRIMER.

8.1.5. REMOVING THE SOUND SUPPRESSOR

⚠ WARNING: THE SOUND SUPPRESSOR BECOMES VERY HOT DURING USE. WAIT FOR THE SUPPRESSOR TO FULLY COOL BEFORE ATTEMPTING TO REMOVE IT.

Unload the rifle and keep the muzzle pointed in a safe direction.

8.1.6 INSTALLING, ADJUSTING, AND USING THE RIFLE SLING

Some rifle slings serve only as simple carrying straps. However, a tactical/competition sling has far more uses. In addition to carrying the rifle, it can serve to improve shooter accuracy by stabilizing the rifle during firing.

Depending on the particular model of ArmaLite® you own, it may be shipped with a carrying strap sling or a tactical/competition sling. Tactical/competition slings can be purchased on our website (ArmaLite Part # EX0081).

For detailed information on the tactical/competition sling, see Technical Note 109: “INSTALLING, ADJUSTING, AND USING THE PRECISION/TACTICAL RIFLE SLING” in the Library on our website, www.armalite.com.

8.1.7 INSTALLING THE BIPOD

The bipod enhances accuracy by providing support to the rifle. If you purchased the optional Harris Bipod, see the included Harris instruction sheets for installation and use instructions.

1. Remove the brass ring at the rear of the bipod. It may be necessary to cut the ring.



2. Remove the sling swivel stud adapter from the bipod.



3. Disassemble the bipod adapter.



4. Attach the bottom plate to the bipod using the square stud, and the bevel bottom plate. The small square will fit into the hole left open by the sling swivel attachment.



5. Attach the top plate to the bipod and tighten the screws. The bipod is now ready for installation to the rifle.



6. Open the lock of the bipod adapter. Hook the fixed side of the adapter over the bottom rail, with the crossbar of the adapter aligned with a slot in the rail. Swing the locking side of the adapter over the rail and push the lock lever parallel to the rail to lock the assembly in place.

8.2 INITIAL INSPECTION

 **WARNING: READ THIS MANUAL COMPLETELY AS YOU INSPECT YOUR NEW ARMALITE® FIREARM. MAKE CERTAIN THAT YOU UNDERSTAND HOW TO ASSEMBLE, OPERATE, DISASSEMBLE, MAINTAIN, AND STORE YOUR FIREARM SAFELY BEFORE YOU USE IT.**

After you have initially assembled your SuperSASS™, (or any time you disassemble and reassemble a firearm), you should conduct a functional check of it. Inspect the function of your SuperSASS™ as described in the REASSEMBLY section of this manual.

7. Visually inspect the rifle to assure that there are no broken, damaged, loose, or missing components.

8.3 INITIAL CLEANING

Clean the bore of your rifle and lubricate the rifle as described in the Maintenance section below. ArmaLite® rifles are manufactured to tighter tolerances than other rifles of similar design. A break-in period of 200 rounds allows machined or phosphate-coated surfaces to smooth out the rifle's action. Lubricate well before firing. No unusual break-in procedures or abrasives are recommended. Merely clean frequently with solvent dampened patches, followed by dry patches. We recommend brass brushes for all cleaning, and recommend specifically AGAINST either stainless steel or nylon brushes.



WARNING: TO ASSURE ITS PROTECTION FROM CORROSION, YOUR ARMALITE® FIREARM HAS BEEN SHIPPED WITH PRESERVATIVE OIL IN THE BORE. FIRING THE FIREARM WITH PRESERVATIVE IN THE BORE CAN INCREASE PRESSURES, WITH POSSIBLE FIREARM DAMAGE OR PERSONAL INJURY OR DEATH. CLEAN AND DRY THE BORE BEFORE FIRING YOUR ARMALITE® FIREARM.

8.4 BREAKING IN MATCH BARRELS

“Match barrels” are any of our stainless steel barrels. Our chrome lined barrels do not require break in. ArmaLite® has spoken with several barrel manufacturers. NONE of them recommend breaking in barrels using abrasives. For optimum accuracy and barrel life, ArmaLite® recommends the following break-in procedure:

1. Fire 9 single shots. After each shot, push a cotton patch wet with solvent through the bore. Then wet a bronze brush with solvent and stroke the barrel five to ten round trips. Follow with another wet patch and then a dry patch or two. (We do NOT recommend nylon or stainless steel brushes.) After you finish, wash the solvent off your brush so that the brush won't deteriorate.
2. From 10 to 30 shots, clean as above after each five shots. Initial break-in should now be complete.

For subsequent, normal cleaning, it is suggested that you clean after each range session. It is often suggested that the barrel be brushed one stroke for each shot fired.

8.5 DRY FIRING YOUR RIFLE

Reasonable amounts of dry firing should not damage your rifle.





CAUTION: NEVER DRY FIRE YOUR RIFLE WITHOUT THE BOLT CARRIER ASSEMBLY INSTALLED. THE FIRING PIN STOPS THE FALL OF THE HAMMER. WITHOUT THE BOLT CARRIER ASSEMBLY INSTALLED, THE HAMMER CAN IMPACT ON THE LOWER RECEIVER, DAMAGING IT.



WARNING: FOLLOW ALL OF THE RULES OF SAFE GUN HANDLING ANYTIME YOU DRY FIRE YOUR FIREARM.

9. LOADING AND FIRING

 **WARNING: ALWAYS KEEP THE SAFETY IN THE “SAFE” POSITION UNTIL YOU ARE READY TO FIRE THE FIREARM. REMEMBER THAT THE SAFETY IS SIMPLY A MECHANICAL DEVICE, AND AS SUCH, COULD POSSIBLY FAIL. NEVER DEPEND ON ANY SAFETY TO JUSTIFY UNSAFE GUN HANDLING. ALWAYS KEEP THE CHAMBER EMPTY AND THE FIREARM POINTED IN A SAFE DIRECTION EVEN WHEN THE SAFETY IS ON.**

 **WARNING: INJURY, DEATH, OR FIREARM DAMAGE CAN RESULT FROM FIRING A FIREARM WITH AN OBSTRUCTION IN THE BORE. BEFORE YOU FIRE, MAKE SURE THAT THE BORE IS NOT OBSTRUCTED. NEVER ATTEMPT TO SHOOT OUT A BORE OBSTRUCTION.**

 **WARNING: ALWAYS WEAR EYE AND EAR PROTECTION. MAKE SURE THAT NEARBY BYSTANDERS ALSO WEAR EYE AND EAR PROTECTION.**

 **WARNING: HANDLING OF CARTRIDGES AND FIRING FIREARMS MAY EXPOSE YOU TO LEAD. ALWAYS ASSURE THAT THERE IS ADEQUATE VENTILATION. ALWAYS WASH YOUR HANDS AFTER HANDLING AMMUNITION OR FIRING YOUR FIREARM.**

 **WARNING: THIS FIREARM WILL FIRE WITHOUT A MAGAZINE IN IT. ALWAYS ASSURE THAT THE CHAMBER IS EMPTY. THE FIREARM SHOULD NOT BE CONSIDERED TO BE SAFE UNLESS THE MAGAZINE IS REMOVED, THE SAFETY IS ON, AND THE BOLT IS OPEN, AND THE CHAMBER IS EMPTY.**

 **WARNING: THE FIRED CARTRIDGE CASE IS HOT WHEN IT IS EJECTED FROM THE FIREARM. DO NOT ALLOW IT TO BURN YOU, OR TO DISTRACT YOU FROM SAFE HANDLING OF THE FIREARM.**

 **WARNING: IF THE FIREARM FAILS TO FIRE WHEN THE TRIGGER IS PULLED:**

- 1. KEEP THE FIREARM POINTED AT THE TARGET!!!**
- 2. WAIT 15 SECONDS TO ALLOW A POSSIBLE “HANGFIRE” TO GO OFF. THEN,**
- 3. CHECK TO SEE IF THE SAFETY IS ENGAGED BY MISTAKE. IF SO, PUSH THE SAFETY TO THE “FIRE” POSITION AND FIRE.**
- 4. IF THE FIREARM STILL DOESN’T FIRE, BE CAUTIOUS AND ASSUME THAT THE CARTRIDGE WILL DISCHARGE WHEN THE BOLT IS OPENED.**
- 5. OPEN THE BOLT QUICKLY AND UNLOAD THE FIREARM.**

6. EXAMINE THE FIREARM AND CARTRIDGE CAREFULLY TO IDENTIFY THE CAUSE OF THE MALFUNCTION.

 **WARNING: RAPID FIRING OF THE FIREARM MAY CAUSE SOME COMPONENTS TO BECOME HOT ENOUGH TO CAUSE INJURY. EXTENDED SESSIONS OF VERY RAPID FIRING MAY CAUSE A CARTRIDGE LEFT IN THE CHAMBER TO “COOKOFF”, FIRING ITSELF WITHOUT YOU PULLING THE TRIGGER. ALWAYS UNLOAD THE FIREARM IMMEDIATELY AFTER YOU FINISH FIRING.**

To prevent cookoffs and maximize barrel life, the rate of fire of the SuperSASS™ should not exceed the following:

- 2 minutes---40 rounds per minute
- 10 minutes----30 rounds per minute
- 20 minutes—20 rounds per minute
- 30 minutes or more---13 rounds per minute

9.1 LOADING THE MAGAZINE

Set the cartridge on the follower, between the feed lips and pointing the same direction as the “bullet” on the follower, and press it straight down until it’s held by the lips of the magazine.

 **CAUTION: CURRENTLY ARMALITE® SELLS 7.62MM MAGAZINES THAT ARE DESIGNED FOR CAPACITIES OF 5, 10, 15, 20, AND 25 ROUNDS. DO NOT EXCEED THESE CAPACITIES. DUE TO VARIATIONS IN DIAMETERS OF VARIOUS BRANDS OF CARTRIDGES, IT MAY BE POSSIBLE TO FORCE AN ADDITIONAL CARTRIDGE INTO A MAGAZINE. DOING SO WILL DAMAGE YOUR MAGAZINE AND LEAD TO ELEVATED MALFUNCTION RATES.**

9.2 LOADING THE SuperSASS™ AND CHAMBERING THE FIRST ROUND

 **WARNING: ALWAYS POINT THE MUZZLE IN A SAFE DIRECTION.**

1. Assure that the rifle is completely unloaded. Pull the charging handle (U-2) rearward, and lock the bolt carrier assembly (U-3) to the rear by pressing the bottom of the bolt stop (L-11) in, then release the charging handle so that the bolt stops on the raised bolt stop.

Place the safety selector (L-22) on “SAFE”. Check to see that the chamber is clear and the bore is not blocked.



2. Push the magazine up into the receiver until the magazine catch (L-15) engages and holds the magazine.

⚠ CAUTION: TAKE IT EASY WITH YOUR MAGAZINES. KEEP THEM CLEAN, DRY, AND DON'T POUND THEM INTO THE RIFLE. IT LOOKS GREAT IN THE MOVIES BUT CAN DAMAGE THEM. INSERT THE MAGAZINE FULLY INTO THE RIFLE THEN TUG DOWNWARD ON IT TO ASSURE IT'S SECURELY LOCKED INTO THE RIFLE.



3. Pull down on the magazine slightly to make sure that it is locked in place.

4. Pull the charging handle completely to the rear and release it smartly to chamber the first round. While it is possible to release the bolt carrier assembly by pushing in on the bolt stop, more energy is provided to chamber the cartridge by pulling the charging handle to the rear and releasing it. . If the bolt carrier doesn't fully close, tap the forward assist (if your rifle is so equipped) to close it. If it still won't close, clear the rifle and correct the problem.

NOTE: During firing, the bolt carrier assembly will automatically lock to the rear when the last round in a magazine is fired and the rifle is empty. Reload by pressing the magazine catch button (L-16) to remove the empty magazine, insert a loaded magazine,

and press the top of the bolt catch or pull the charging handle to the rear and release it (preferred).



CAUTION: NEVER “RIDE” THE CHARGING HANDLE FORWARD. LET IT SLIDE FORWARD AT FULL SPEED.

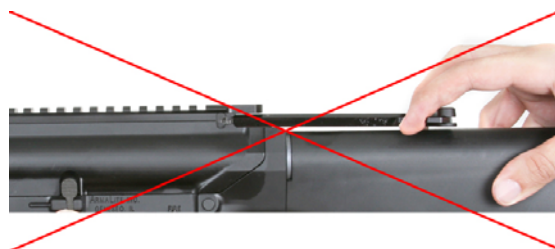

NOTE: The cartridges in a fully loaded magazine can be packed tight and require firm upward pressure to assure that the magazine catch holds the magazine. It’s always easiest to insert the magazine when the bolt carrier assembly (U-3) is locked to the rear. In addition, using the charging handle to release the bolt carrier assembly provides more energy for chambering.

9.3 EMPLOYING THE FORWARD ASSIST MECHANISM

Your AR-10 is equipped with a forward assist mechanism. The mechanism is NOT intended to force a cartridge into the chamber if the cartridge does not fully chamber under the power of the recoil spring. If you encounter a cartridge that will not chamber, remove the magazine, and clear the offending round. Clean the rifle (particularly the chamber) if needed, reinstall the magazine, pull the charging handle completely to the rear to obtain maximum energy, and allow the bolt carrier assembly to go forward under its own power.

After you have fully chambered a cartridge, if you forget whether the chamber is loaded, you can partially retract the bolt carrier to visually inspect for a cartridge. In that case, the recoil spring may not have enough energy to relock the bolt. If that occurs, the forward assist mechanism may be used to rechamber/relock a round that has already been fully chambered.



CAUTION: THE FORWARD ASSIST MECHANISM IS NOT INTENDED TO FORCE THE EXTRACTOR OVER A PARTIALLY CHAMBERED CARTRIDGE. FORCING THE FORWARD ASSIST MAY DAMAGE IT, AND MAY RESULT IN A CARTRIDGE THAT IS MORE TIGHTLY WEDGED THAN BEFORE.

9.4 FIRING

Aim at the target. Set the safety selector (L-22) to “FIRE”, grip the rifle firmly, and pull the trigger (L-30) straight to the rear, increasing the pressure until the shot fires.



⚠️ WARNING: KEEP THE SAFETY ON SAFE UNTIL YOU ARE READY TO SHOOT. UNLOAD AND CLEAR YOUR RIFLE BEFORE LEAVING THE FIRING POSITION.

⚠️ WARNING: GRIPPING THE RIFLE LOOSELY WHEN FIRING CAN CAUSE THE SHOOTER TO FIRE TWO SHOTS (THE SECOND AS THE TRIGGER STRIKES THE SHOOTER’S TRIGGER FINGER DURING COUNTER-RECOIL.) THIS IS A SHOOTER ERROR, NOT A RIFLE MALFUNCTION.

⚠️ CAUTION: DO NOT REST THE RIFLE ON ITS MAGAZINE WHEN YOU ARE LOADING OR FIRING IT. DOING SO CAN FORCE THE MAGAZINE UP INTO THE RIFLE, REDUCING THE RELIABILITY OF FEEDING CARTRIDGES.

10. CLEARING / UNLOADING THE FIREARM



WARNING: ALWAYS ASSUME ALL FIREARMS ARE LOADED. ANYTIME YOU HANDLE A FIREARM, YOU SHOULD IMMEDIATELY INSPECT IT TO ASSURE THAT IT IS COMPLETELY UNLOADED.



WARNING: IF YOU KNOW NOTHING ELSE ABOUT YOUR ARMALITE® FIREARM, YOU MUST KNOW HOW TO UNLOAD IT AND CLEAR IT TO MAKE IT SAFE.

1. Place the safety selector (L-22) on “SAFE”.

NOTE: If the firearm is not cocked, the lever cannot be pointed toward “SAFE”.

2. Remove the magazine by pressing the magazine catch button (L-16) and pulling the magazine down and out of the receiver.

NOTE: Some legal jurisdictions require use of a tool to remove the magazine. ArmaLite firearms sold to such jurisdictions contain a magazine catch button that has been inset so that you will need to use a bullet nose or other similar tool to release the magazine.



CAUTION: THE MAGAZINE WILL FALL FREE WHEN THE MAGAZINE CATCH IS PRESSED. DON'T ALLOW THE MAGAZINE TO FALL ONTO A HARD SURFACE. DOING SO MAY DAMAGE THE MAGAZINE.

3. Extract the cartridge (if any) from the chamber. To extract a cartridge pull the bolt carrier assembly (U-3) fully to the rear. If there is a cartridge in the chamber, it should be extracted and ejected from the firearm.
4. Look into the chamber to assure that it does not contain a cartridge.



WARNING: NEVER ASSUME THAT THE CHAMBER IS EMPTY UNTIL YOU HAVE VISUALLY EXAMINED IT AND SEE THAT IT IS EMPTY.

5. Remove any remaining cartridges from your magazines.



WARNING: THE STEPS IN UNLOADING YOUR FIREARM MUST BE FOLLOWED IN THE EXACT ORDER GIVEN. THE MAGAZINE MUST BE REMOVED BEFORE THE CHAMBER IS INSPECTED. IF YOU CLEAR THE CHAMBER BEFORE REMOVING THE MAGAZINE, YOU MAY REMOVE ONE CARTRIDGE FROM THE CHAMBER AND THEN, UPON CLOSING THE BOLT, CHAMBER ANOTHER CARTRIDGE FROM THE MAGAZINE. THE FIREARM WILL STILL BE LOADED. REMEMBER THAT A CARTRIDGE IN THE CHAMBER CAN STILL BE FIRED EVEN AFTER THE MAGAZINE IS REMOVED.

11. ZEROING THE SIGHTS

11.1 ZEROING THE TELESCOPIC SIGHT

Your SuperSASS™ is designed to use a telescopic sight as its primary sighting device. To install and zero the scope on your SuperSASS™, follow the instructions in your scope owner's manual.



WARNING: MAKE CERTAIN THAT THE SCOPE IS MOUNTED FAR ENOUGH FORWARD SO THAT IT WILL NOT IMPACT YOUR FACE DURING RECOIL. CHECK THE DISTANCE BETWEEN THE SCOPE AND YOUR FACE WHEN YOU ARE IN THE FIRING POSITION. WHEN IN DOUBT INCREASE THE EYE RELIEF.

11.2 ZEROING THE RIFLE WITH THE SUPPRESSOR INSTALLED

The normal disruption of muzzle gases and the added weight of the sound suppressor on the barrel will normally shift the zero of a rifle. This shift may vary with different cartridges. Establish both the suppressed and unsuppressed zero of the rifle and use them as appropriate.

12. DISASSEMBLY

 **WARNING: ALWAYS UNLOAD YOUR FIREARM BEFORE CLEANING, LUBRICATION, DISASSEMBLY, OR REASSEMBLY.**

 **WARNING: ALWAYS WEAR SAFETY GLASSES WHEN DISASSEMBLING, MAINTAINING, OR ASSEMBLING YOUR FIREARM. IN PARTICULAR, THE OPERATING SPRING IS UNDER HIGH COMPRESSION. IF IT SLIPS FROM YOUR GRASP, IT COULD CAUSE INJURY.**

12.1 CLEAR THE RIFLE

IMPORTANT: Put the safety selector (L-22) on “SAFE”. Remove the magazine, THEN pull back the charging handle (U-2) and visually inspect the chamber.



12.2 REMOVE THE SLING.

12.3 UPPER AND LOWER RECEIVERS

1. Push the takedown pin (L-21) as far as it will go.



2. Pivot the upper receiver (U-1) from the lower receiver (L-1).
3. Push the pivot pin (L-18) as far as it will go.



4. Separate the upper and lower receivers.



12.4 CHARGING HANDLE AND BOLT CARRIER ASSEMBLY

1. Pull back the charging handle (U-2) and bolt carrier assembly (U-3).

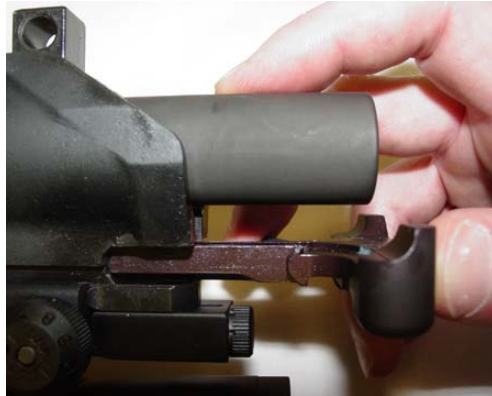

2. Remove the bolt carrier assembly (U-3).



3. Pull the charging handle back and down to remove it.



4. Move the bolt assembly (BC-8) forward to the unlocked position. The firing pin retaining pin (BC-1) is retained in the carrier assembly by friction. Press it out of the bolt carrier to remove the firing pin (BC-2). Do not open or close the split end of the firing pin retaining pin.



5. Push in on the bolt assembly (BC-8) to put it in the locked position.



6. Catch the firing pin (BC-2) as it drops out of the rear of the bolt carrier assembly.

NOTE: It is not necessary to remove the firing pin spring (BC-3) from the firing pin (BC-2).



7. Lift the cam pin (BC-4) straight out.



8. Remove the bolt assembly (BC-8) from the bolt carrier assembly.



9. Press the rear of the extractor (B-6) to check that the spring works.



10. Remove the extractor pin (B-7).



11. Remove the extractor and spring assembly.

NOTE: Do not remove the spring assembly (B-4), its insert (B-3), or the O-ring (B-5) from the extractor.

12.5 LOWER RECEIVER ASSEMBLY



1. Cock the hammer (L-26) with your thumb. Push in the buffer (L-5) and depress the buffer detent (L-6) to release the buffer.



2. Remove the buffer (L-5) and the operating spring (L-4).



12.6 DISASSEMBLING THE MAGAZINE

Use the tip of a cartridge or another suitable tool to very slightly pry the rear of the floorplate up so that it can be pulled off the magazine.



Remove the spring and attached follower from the magazine shell. The spring will exit the shell easily, but the follower must be twisted and withdrawn, rear first. Do not remove the spring from the follower.

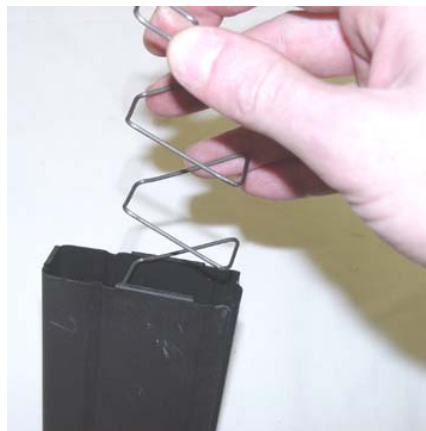

NO FURTHER DISASSEMBLY OF THE FIREARM IS REQUIRED.

13. MAINTENANCE

 **WARNING: ALWAYS UNLOAD YOUR FIREARM BEFORE CLEANING, LUBRICATION, DISASSEMBLY, OR REASSEMBLY.**

 **WARNING: DO NOT APPLY LUBRICANT OR PRESERVATIVE TO YOUR AMMUNITION. DOING SO MAY CAUSE THE CARTRIDGE TO PARTIALLY MALFUNCTION, LEAVING THE BULLET LODGED IN THE BORE, CREATING A BORE OBSTRUCTION.**

13.1 CLEANING SOLVENTS AND LUBRICANTS AND EQUIPMENT

Lubricate generously with CLP (Cleaner, Lubricant, and Preservative), LSA, or other high-quality firearms lubricants, especially on the highly-stressed Bolt Carrier Group. High quality cleaning solvent like Hoppes No. 9 removes metal fouling from the bore excellently.

 **CAUTION: UNDER NO CONDITIONS SHOULD ANY LUBRICANT CONTAINING GRAPHITE BE USED WITH YOUR RIFLE. GRAPHITE CAN ENCOURAGE RAPID CORROSION TO THE AIRCRAFT-GRADE ALUMINUM USED IN YOUR RIFLE.**

In addition to cleaning solvents and lubricants, the basic cleaning equipment you will need includes a cleaning rod, brass bore brush, chamber brush, toothbrush, patches, pipe cleaners, and the most important item: a lint-free cloth. ArmaLite®® recommends a pull-through cleaning cable for efficient, breech-to-muzzle cleaning.

13.2 UPPER RECEIVER AND BARREL ASSEMBLY

During firing, the suppressor stores propellant gasses and slows their exit from the system. Much of that propellant gas travels back down the barrel and into the rifle action. The SuperSASS™ will therefore require more frequent cleaning when fired with the suppressor installed.

1. To properly maintain your SuperSASS™ gas regulator system, there are a few steps that must be performed. If you plan on firing the SuperSASS™ rifle with the suppressor on the rifle, the gas regulator (8) MUST be set to the “SUPP” position. If the suppressor is removed, the gas regulator must be in the NORM position. If the SuperSASS™ is fired mainly with a suppressor, the gas regulator should be cleaned every hundred rounds. This is done by removing the suppressor, placing the regulator in the “NORM” position, and firing a single twenty round magazine through the rifle to ensure the “NORM” position gas port remains open. Prolonged firing in either the suppressed or unsuppressed mode without cleaning may cause the gas regulator to become frozen or difficult to move. During the cleaning of the rifle, a small amount of oil or penetrant into the back of the regulator, where the gas tube cylinder meets the gas block, will help the regulator to move properly.



CAUTION: PROTECT THE RIFLE FROM CONDENSATION

The gasses generated during firing contain a surprising amount of water vapor. This water vapor can condense in the suppressor (especially a cool suppressor) and travel down into the rifle bore if the rifle is stored pointing up. Until all possible moisture is dried out, store the rifle with the muzzle down to prevent water from traveling through the bore and into the action.

NOTE: A small amount of powder residue normally seeps from under the front sight/gas block and the recoil check. This is normal, but cannot be seen on phosphated barrels. It can be seen on stainless steel barrels but presents no problem.



CAUTION: DON'T REVERSE THE DIRECTION OF THE BORE BRUSH WHILE IT'S IN THE BORE.



2. Use CLP to clean the bore and chamber, the gas tube (10), the upper receiver and barrel assembly, locking lugs and all areas of powder fouling, corrosion, dirt or dust.



WARNING: LEAD MAY BE PRESENT IN THE FOULING OF A DIRTY RIFLE. AVOID CONTACT WITH IT, AND CLEAN HANDS AFTERWARD TO AVOID INGESTING LEAD.

3. Using a cleaning rod, bore brush and cleaning solvent, run the rod through the chamber and flash suppressor (U-11) (if applicable) several times.



4. Install the chamber brush on the cleaning rod, dip it in cleaning solvent, and insert it into the chamber and locking lugs. Clean by pushing and twisting the cleaning rod.



5. Use a worn out bore brush to clean the outside surface of the protruding gas tube (U-10) (Get the sides and bottom from the bottom of the upper receiver). **NOTE: This procedure ruins the brush.**



NOTE: Gas tubes will discolor from heat. Do not try to remove this discoloration.

⚠ CAUTION: DO NOT TRY TO CLEAN THE INSIDE OF THE GAS TUBE. IT IS NOT NEEDED WITH GOOD QUALITY PROPELLANT, OR EFFECTIVE WITH BAD PROPELLANT.

⚠ CAUTION: DO NOT BEND THE GAS TUBE; IF THE TUBE IS BENT IT WILL SLOW OR BLOCK FORWARD MOVEMENT OF THE BOLT CARRIER ASSEMBLY.

6. Take the bore brush off the rod and install a swab holder and a swab. Apply cleaning solvent to the swab, then run it through the chamber and out the flash suppressor (U-11). To remove carbon build up, let the solvent sit, then wipe clean. A bore brush may be used with care to remove heavy carbon buildup. Wipe the bore dry by running clean swabs all the way through from the chamber and out the muzzle. REMEMBER, do not change directions in the bore.



Inspect the barrel, gas tube, and hand guards for cracks, bends, or breaks. Be sure the barrel has no obstructions.

7. Lightly lubricate the bore and chamber and the outer surfaces of the rifle.

8. Lubricate the bore with a lubricated swab, running the rod from the receiver to the muzzle.

9. The hidden surfaces of the locking lugs of the barrel must be cleaned and protected. Place a chamber cleaning brush on the chamber cleaning tool. Dampen the brush with CLP and screw it into the chamber with a clockwise motion until the wide diameter steel brushes enter the barrel extension. Rotate the brush three times and, while continuing to rotate clockwise, pull it from the chamber.



If no brush is available, place two cleaning patches on a cleaning rod with one end of the patches protruding only slightly, and the other end protruding approximately two inches. Wet the patches well with CLP and wash the hidden areas of the barrel extension by placing the patches in close contact and rotating the rod.



Alternatively, place a patch on the steel bristles of a very worn and unserviceable chamber brush and use it to press the patch against the hidden surfaces.



10. Lubricate the locking lugs.



13.3 CHARGING HANDLE AND BOLT CARRIER ASSEMBLY

1. Clean all parts and outer surfaces of the bolt carrier assembly with a swab saturated with cleaning solvent.



2. Clean the bolt carrier key (BC-7) with a worn bore brush dipped in solvent and dry with a pipe cleaner.



3. Remove carbon deposits and dirt from the bolt locking lugs with a bore brush dipped in solvent.



4. Clean the areas behind the gas ring (B-1) and under the lip of the extractor (B-6).

5. Press the ejector (B-10) in repeatedly to remove accumulated brass shavings from the ejector hole and assure the ejector moves freely. Lubricate it generously.



6. Inspect the charging handle for cracks, bends or breaks.
7. Inspect the bolt assembly for cracks or fractures, especially in the cam pin hole area.

⚠ WARNING: DO NOT INTERCHANGE BOLTS BETWEEN RIFLES.

8. Inspect the firing pin retaining pin (BC-1) for bends, breaks, or dents.



9. Inspect the cam pin (BC-4) for cracks or chips. Assure that the firing pin spring (BC-2) is installed with the tight end in the firing pin's groove.

10. Inspect the firing pin for bends, cracks, or a sharp, chipped, or blunted tip.



11. Lightly lubricate the firing pin and firing pin recess in the bolt assembly.
12. Generously lubricate the outside of the cam pin (BC-4) and the firing pin retaining pin (BC-1). Make certain to lubricate the bolt's cam pin hole, gas ring, and the outside of the bolt.

13. Lightly lubricate the inner and outer surfaces of the bolt carrier (BC-5).



14. Lightly lubricate the charging handle.



15. Dry the key of the bolt carrier assembly with a pipe cleaner. Place one drop of lubricant inside the bolt carrier key (BC-7).



NOTE: Carbon in the groove at the bottom of the gas cylinder in the carrier cannot accumulate enough to become a problem. Efforts to remove it cause more damage than leaving it. Avoid the instinct to over clean your rifle.

13.4 LOWER RECEIVER ASSEMBLY

 **CAUTION: DO NOT USE A WIRE BRUSH OR ANY TYPE OF ABRASIVE MATERIAL TO CLEAN ALUMINUM SURFACES**

1. Wipe dirt from the trigger (L-30) with a swab.
2. Use a swab and cleaning brush to clean powder fouling, corrosion, and dirt from the lower receiver (L-1).



3. Use a pipe cleaner to clean the buttstock screw vent hole.



4. Clean the buffer (L-5), operating spring (L-4), and inside lower receiver with a swab dipped in solvent then lubricate them lightly.



5. Examine the lower receiver assembly for a broken or bent trigger, buttstock, corroded or deformed lower receiver, cracked or damaged pistol grip (L-8), and bent or damaged safety selector (L-22). Look at the inside parts for cracks, dents, or breaks.
6. Generously lubricate the takedown and pivot pin and the inside parts of the lower receiver assembly.



WARNING: ARMALITE®'S NATIONAL MATCH TRIGGER ASSEMBLY ISN'T USER ADJUSTABLE. FOR SAFETY REASONS, IT IS INTENTIONALLY BUILT WITH A SMALL AMOUNT OF CREEP IN THE SECOND STAGE. AS IT BREAKS IN WITH USE (200 TO 500 ROUNDS) THE CREEP TENDS TO DECREASE TO AN ACCEPTABLE LEVEL. IF EXCESS CREEP REMAINS, THE TRIGGER CAN BE TUNED BY A GUNSMITH USING TECHNIQUES SIMILAR TO THOSE USED WITH THE M1 / M14 TRIGGER SYSTEM. ARMALITE® TECHNICIANS WILL FINE-TUNE THE TRIGGERS FOR A NOMINAL SHOP FEE, PLUS SHIPPING.

13.5 MAGAZINE

The magazine is one of the most important parts of a rifle... and one of the most neglected. Failure to keep the magazine cleaned and properly lubricated will result in early and frequent malfunctions. It should be cleaned and lubricated whenever contaminated inside with water, sand, or dirt.

Clean the follower, shell, spring, and floorplate, and lubricate them with CLP. The magazine is ready for reassembly.

13.6 MAINTAINING THE CAMOUFLAGE LAYER (IF PRESENT)

Clean the baked on finish of the SuperSASS™ using a cloth moistened with mild soapy water. Wipe with a clean damp rag. CLP may be used to remove stubborn powder stains. Use CLP to lubricate and protect any steel surfaces that have been cleaned.

The standard hard coat anodize surface layer is intended as a base for any spray-on paints suitable to the operational area in which the SuperSASS™ System is being employed.

13.7 SOUND SUPPRESSOR

1. Clean the outside of the suppressor with a CLP dampened cloth. Copper removing bore cleaner such as "Hoppe's No. 9" may be used to remove copper fouling from the suppressor.
2. Brush the contact areas of the suppressor and compensator/adaptor contact areas to remove carbon and other fouling. Fouling will render re-attachment of the suppressor difficult.

⚠ CAUTION: DO NOT USE ABRASIVES TO CLEAN THE BEARING SURFACES. SURFACE DAMAGE REDUCES ACCURACY WHEN FIRING WITH THE SUPPRESSOR ATTACHED AND INCREASES POWDER FOULING.

⚠ CAUTION: NEVER MIX TWO OR MORE BORE CLEANING SOLVENTS. SOME COMBINATIONS OF SOLVENTS PRODUCE ACIDS WHICH MAY DAMAGE RIFLE OR SUPPRESSOR METALS.

NOTE: Do not allow solvent to flow into the suppressor body. Keep the suppressor “muzzle up” when brushing the inside or when soaking the compensator/adapter contact area.

NOTE: The suppressor is a precision instrument having a tight fit between the bearing surfaces of the compensator/adapter. To assure a proper fit, the compensator/adapter must be kept free of dirt or carbon fouling.

3. Brush and/or scrape the carbon and copper residue from the suppressor mounting surfaces and the compensator/adapter. Take care to assure that carbon doesn't fall into the rifle bore or into the suppressor body.



13.8 LONG TERM STORAGE

Clean your firearm well and apply a good quality preservative.

It is at least theoretically possible for some springs to take a set during prolonged storage. To preclude this possibility, ArmaLite offers the following recommendations regarding long term storage of your firearm.



WARNING: FOLLOW ALL OF THE RULES OF SAFE GUN HANDLING ANYTIME YOU DRY FIRE YOUR FIREARM.



CAUTION: NEVER DRY FIRE YOUR FIREARM WITHOUT THE BOLT CARRIER ASSEMBLY INSTALLED. THE FIRING PIN STOPS THE FALL OF THE HAMMER. WITHOUT THE BOLT CARRIER ASSEMBLY INSTALLED, THE HAMMER CAN IMPACT ON THE LOWER RECEIVER, DAMAGING IT.

Reasonable amounts of dry firing should not damage your firearm.

Clear all cartridges from your firearm. Remove the magazine. Then pull back the charging handle and visually confirm that the chamber is empty and that there is no cartridge held to the bolt face by the extractor. Then check it again. Then dry fire the firearm to allow the hammer to rotate to the fired position.

It is always best to store your magazines empty. However if you need to store them loaded, we recommend that you store them with 5 rounds less than their stated capacity.

When you're taking your firearm out of long term storage, remove the preservative and lubricate as stated elsewhere in this manual.

14. REASSEMBLY

 **WARNING: ALWAYS UNLOAD YOUR FIREARM BEFORE CLEANING, LUBRICATION, DISASSEMBLY, OR REASSEMBLY.**

14.1 LOWER RECEIVER ASSEMBLY

1. Insert operating spring (L-4) and buffer (L-5).



14.2 CHARGING HANDLE AND BOLT CARRIER

NOTE: The extractor has a silicone insert (B-3) in the spring and a silicone o-ring (B-5) around the spring. Don't lose them.

1. If the spring comes loose, seat the large end of the spring in the extractor. Assure the o-ring is around the spring.



2. Insert the extractor with spring assembly into bolt.
3. Push extractor until the holes in the extractor and bolt are aligned and insert the extractor pin.



4. Slide the bolt assembly into the bolt carrier **ONLY FAR ENOUGH TO INSERT THE CAM PIN.**



⚠ CAUTION: INSERT THE BOLT INTO THE CARRIER ONLY DEEPLY ENOUGH TO ALLOW THE CAM PIN TO BE INSERTED. THERE IS A GROOVE INSIDE THE CARRIER AT THE BOTTOM OF THE GAS CAVITY. INSERTING THE BOLT TOO FAR INTO THE CARRIER WITHOUT THE CAM PIN IN PLACE CAN, IN SOME CASES ALLOW THE MCFARLAND GAS RING TO EXPAND SLIGHTLY INTO THE GROOVE AND JAM THE BOLT IN THE CARRIER. REMOVAL CAN ORDINARILY BE PERFORMED BY WIGGLING THE BOLT SLIGHTLY. BUT, IT MIGHT REQUIRE DRIVING THE BOLT FORWARD WITH A BRASS ROD. THIS CAN DAMAGE OR DESTROY THE GAS RING. THE ERROR CANNOT BE MADE WHEN THE CAM PIN IS IN PLACE.

5. Insert the cam pin (BC-4).



⚠ CAUTION: EASY DOES IT! INSERT THE CAM PIN STRAIGHT INTO THE CARRIER WITH THE FLAT EDGE OF THE CAM PIN AGAINST THE CARRIER KEY (YOU DON'T ROTATE IT 90 DEGREES LIKE THE M-15 CAM PIN). UNTIL PARTS ARE LOOSENED BY BREAKING THEM IN, TIGHT TOLERANCES ON THE AR-10 SOMETIMES REQUIRE USE OF A FLAT TIPPED SCREWDRIVER OR OTHER SUITABLE OBJECT TO SLIP THE CAM PIN PAST THE BOLT CARRIER KEY. THE CAM PIN MUST NEVER BE ALTERED TO PROVIDE CLEARANCE.

6. Drop the firing pin (BC-2) into its opening. Press the firing pin forward about 1/8 inch after feeling spring resistance. This allows the firing pin retaining pin (BC-1) to be inserted behind the large flange of the firing pin, and thereby hold it in position.

7. The tight end of the spring engages a groove in the firing pin, which prevents the spring's loss. Verify that the tight end of the firing pin spring engages the groove on the firing pin.



! WARNING: THE FIRING PIN SPRING IS AN IMPORTANT SAFETY DEVICE AND MUST NOT BE LOOSE, REMOVED, OR LOST. THE AR-10 FIRING PIN SPRING MAKES SLAMFIRE VIRTUALLY IMPOSSIBLE WHILE MAINTAINING RELIABLE IGNITION. ARMALITE® WILL PROVIDE A FREE REPLACEMENT IF IT IS LOST OR DAMAGED.

8. Pull the bolt assembly (BC-8) forward and insert the firing pin retaining pin (BC-1) in the area behind the large flange of the firing pin. Push the firing pin to verify that the spring returns it rearward.



! CAUTION: DO NOT POUND OR FORCE THE FIRING PIN RETAINING PIN INTO POSITION. TO CHECK FOR PROPER ASSEMBLY OF THE AR-10 BOLT CARRIER ASSEMBLY, HOLD IT WITH THE BOLT UP TO VERIFY THAT THE FIRING PIN DOESN'T FALL OUT. PUSH FORWARD ON THE REAR OF THE FIRING PIN AND MAKE SURE THAT IT IS PUSHED BACK BY THE FIRING PIN SPRING. REPLACE THE RETAINING PIN IF IT IS DAMAGED.

9. Turn the bolt carrier assembly up and try to shake out the firing pin. The firing pin must not fall out.



10. Place the charging handle into the upper receiver and engage the handle's lugs with the track in the receiver, then push the charging handle part way into the upper receiver.



11. Slide the bolt carrier assembly, bolt extended, into the upper receiver.



12. Push the charging handle assembly and bolt carrier assembly together into the upper receiver.



14.3 UPPER AND LOWER RECEIVERS

NOTE: The hammer must be in cocked position to join receivers.

1. Join the upper and lower receivers.
2. Align the pivot pin holes with the pivot pin and push the pivot pin in.



⚠ CAUTION: CLOSE THE EJECTION PORT COVER BEFORE THE RECEIVERS ARE JOINED TO PREVENT DAMAGE TO THE COVER.

3. Close the upper and lower receivers. Push in the takedown pin.



NOTE: Normal forging and manufacturing variations may result in slight overhang or play. This will not affect function or accuracy.

14.4 SLING

Attach the sling.

14.5 REASSEMBLING THE MAGAZINE

Insert the follower and spring assembly into the magazine shell. Insert the right front corner of the follower into the magazine and roll the rear of the follower into the shell. This step will take some practice.

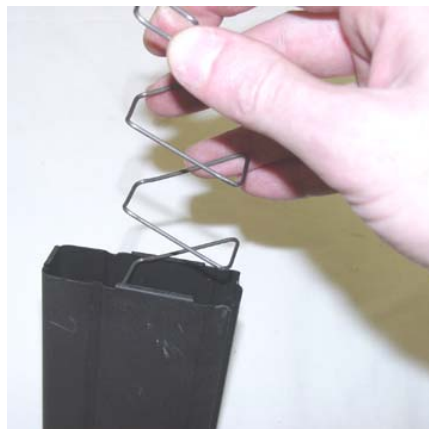

With the follower and spring held in the magazine shell, the floorplate is easily slipped under the tabs at the bottom of the magazine.

14.6 FUNCTIONAL CHECK

1. Remove the magazine and visually inspect the chamber to assure that it is empty. Install an empty magazine. Assure that it is caught solidly by the magazine catch.
2. Pull the charging handle (U-2) to the rear and release it. The bolt should remain to the rear against the bolt stop (L-11). Remove the magazine. Press in on the bolt stop. The bolt carrier assembly should be propelled forward by the operating spring.



3. Place the safety (L-22) on SAFE. Squeeze the trigger (L-30). The hammer should NOT fall.
4. Place the safety (L-22) on FIRE. Squeeze the trigger (L-30) and hold the trigger to the rear; the hammer should fall.
5. Pull the charging handle (U-2) to the rear and release it. Release the trigger. *You should hear a click as you release the trigger.* Squeeze the trigger again. The hammer should fall.



CALL ARMALITE® AT (309) 944-6939 IF YOUR RIFLE FAILS THIS TEST.

15. TROUBLESHOOTING

PROBLEM	CHECK FOR	WHAT TO DO
WON'T FIRE	Selector lever on "SAFE" Improper assembly of firing pin	Put it on "FIRE". Assemble correctly.
	Oil or fouling in bolt	Clean with pipe cleaner.
	Defective ammunition	Remove and discard.
	Too much carbon on firing pin or firing pin recess	Clean.
	Bolt not fully locked.	Extract cartridge, clean area.
BOLT WON'T LOCK	Dirty bolt	Clean.
	Burred or broken bolt	Contact ArmaLite®.
	Ejector stuck	Contact ArmaLite®.
	Dirt, corrosion, or carbon buildup in barrel locking lugs	Clean lugs.
WON'T EXTRACT	Broken extractor spring	Replace.
	Inner spring or reinforcement ring missing from extractor spring	Replace.
	Dirty, corroded, or reloaded ammunition	Remove and discard.
	Carbon in chamber	Clean chamber.
	Frozen or worn extractor	Remove and clean.
	Restricted buffer assembly	Remove and clean.
	Restricted movement of bolt carrier assembly.	Remove, clean and lubricate.

TROUBLESHOOTING (CONTINUED)

PROBLEM	CHECK FOR	WHAT TO DO
WON'T EXTRACT	Clogged gas tube	Replace.
	Short recoil	See below.
	Gas regulator incorrectly set	Set to NORM if not using suppressor.
WON'T FEED	Dirty, corroded, or reloaded ammunition	Remove and discard.
	Dirty or defective magazine	Clean and lubricate or replace.
	Too many rounds in magazine	Remove excess rounds.
	Buffer assembly is restricted	Take out and clean buffer and spring.
	Magazine not fully seated	Adjust magazine catch: Press button on right side, and turn catch on left. Clockwise tightens.
OVERLY FAST OPERATION	Short recoil	See below.
	Gas regulator set to NORM when using suppressor.	Set to SUPP
DOUBLE FEED	Defective magazine	Replace.
WON'T CHAMBER	Dirty corroded or defective ammunition.	Remove and discard.
	Ejector stuck	Clean and oil.
	Carbon in carrier key or chamber	Clean.

TROUBLESHOOTING (CONTINUED)

PROBLEM	CHECK FOR	WHAT TO DO
SHORT RECOIL	Rings worn or too loose.	Replace.
	Carbon or dirt in carrier key or on outside of gas tube	Clean.
	Q-tip/pipe cleaner stuck inside carrier key	Remove.
	Weak or reloaded ammunition	Replace with factory fresh Ammunition. Quality match ammo is recommended.
	Loss of gas power	Check entire gas path, especially carrier key.
	Dirty rifle	Clean.
	Improper lubrication	Lubricate generously.
	Incorrect gas regulator setting	Set regulator to "NORM" when firing without a suppressor, or when firing with the dummy suppressor.
BOLT FAILS TO LOCK OPEN AFTER LAST ROUND	Defective magazine	Replace.
	Dirty or corroded bolt catch	Clean or replace.
SELECTOR LEVER BINDS	Needs oil	Lubricate.
	Dirt or sand under trigger.	Clean.

TROUBLESHOOTING (CONTINUED)

PROBLEM	CHECK FOR	WHAT TO DO
BOLT CARRIER “HUNG UP”	Round jammed between bolt and charging handle and/or double feed	<ol style="list-style-type: none">1. Remove magazine.2. Push in on bottom of bolt catch.3. Bang rifle butt on ground, bolt should shift to rear.4. While bolt is held to rear, round should fall out through magazine well.

NOTE: If this procedure fails, use a cleaning rod to push bolt fully to the rear through the ejection port.

16. WARRANTY, SERVICE, AND SUGGESTIONS

I. DURATION OF WARRANTY:

This warranty applies for all ArmaLite® and Eagle Arms firearms for the duration shown below:

--Lifetime for ArmaLite® Series: M-15™, AR-10®, AR-30™, AR-50™, and SPR MOD 1™

--Five years for ArmaLite® Series: AR-24™

--One year for ArmaLite® Series AR-180 and all Eagle Arms firearms

II. LIMITATIONS OF WARRANTY AND LIABILITY:

ArmaLite, Inc warrants, to the initial retail purchaser, that this firearm is free of manufacturing defects in material or workmanship for the above shown period of ownership by the original purchaser. During this period, ArmaLite agrees to correct your firearm by repair, or replacement (at ArmaLite's discretion) with the same or comparable model. A service or handling charge may be made. This warranty is nontransferable. This warranty applies only to personal use by the first individual owner. All Institutions, including Law Enforcement agencies, receive a Limited One Year Warranty for all firearms.

THIS WARRANTY AUTOMATICALLY BEGINS ON THE DAY THAT THE ORIGINAL RETAIL CUSTOMER PURCHASES HIS ARMALITE. YOU ARE NOT REQUIRED TO INITIALLY REGISTER YOUR ARMALITE.

HOWEVER, TO MAKE A WARRANTY CLAIM, YOU MUST FOLLOW THE PROCEDURE OUTLINED IN “III. INSTRUCTIONS FOR RETURNING FIREARMS FOR SERVICE/REPAIR” BELOW.

IN ORDER TO MAKE A WARRANTY CLAIM, YOU WILL NEED TO SUBMIT, WITH YOUR FIREARM, A COPY OF YOUR ATF FORM 4473 (FIREARMS TRANSACTION RECORD), OR A DATED BILL OF SALE WITH YOUR NAME AND ADDRESS, OR A SALES RECEIPT. TO MAKE SURE THAT YOU ALWAYS HAVE THOSE AVAILABLE, WE RECOMMEND STAPLING THEM TO THE INSIDE BACK COVER OF YOUR OWNER'S MANUAL AS SOON AS YOU PURCHASE YOUR ARMALITE FIREARM.

This warranty is void if the firearm has been abused, misused, damaged, fired with handloaded or reloaded, or improper ammunition, or with an obstruction in the barrel, or damaged by failure to perform proper maintenance. This warranty does not apply to normal wear or any parts, including their surface finish, or if unauthorized repair or alteration has been performed.

The terms of this warranty cannot be changed except in writing by ArmaLite. Wholesalers or Dealers, unless authorized by ArmaLite in advance, are not authorized to make any warranty repair or adjustment on behalf of ArmaLite. This warranty

gives only the original retail purchaser specific legal rights; other rights may also be available which may vary from state to state.

III. INSTRUCTIONS FOR RETURNING FIREARMS FOR SERVICE/REPAIR:

1. Before seeking any service on your ArmaLite firearm: use the troubleshooting guide in the Operator's Manual to attempt to solve the problem; perform all instructed maintenance; and assure that ammunition and magazines are correct and in good condition. **Shop rates plus the cost of return shipping will be applied if no covered defect is found.** A downloadable copy of the current owner's manual for any ArmaLite firearm is available for free in the Library section of ArmaLite's website. Additional technical information can be found in "Technical Notes" in the Library section of ArmaLite's website.

2. Call ArmaLite Customer Service and obtain a Return Material Authorization (RMA) number. During the call, provide our Customer Service Associate with all of the information that he/she requests so that we will be able to expedite resolution of your problem. **ArmaLite will not accept for service any firearm received without a Return Material Authorization (RMA) number.** Call 800-336-0184 Ext 211 to receive your RMA number.

3. Include all needed documentation with your firearm when you return it. Include a letter that:

- a. describes the problem that you're experiencing;
- b. provides all of your contact info (name, address, email, phone, etc) so that we can contact you if necessary
- c. lists the RMA number given to you by our Customer Service.

d. IN ORDER TO RECEIVE SERVICE UNDER WARRANTY, YOU MUST ALSO INCLUDE A COPY OF YOUR ATF FORM 4473 OR A DATED BILL OF SALE WITH YOUR NAME AND ADDRESS, OR A SALES RECEIPT.

If your letter is incomplete, or illegible, we will not be able to honor the warranty and we may not be able to complete needed repairs, so please write legibly.

Note: Rather than writing a letter, you may, if you choose, print a copy of ArmaLite's Return Material Authorization (RMA) form from our website, fill it in completely, and send it with your firearm. If you're seeking warranty repair, don't forget to include your proof of purchase as described in 3.d. above.

4. Remove all ammunition and accessories (scopes, slings, bipods, etc) from the firearm.



WARNING: MAKE ABSOLUTELY SURE THAT THE FIREARM IS UNLOADED!!! BELIEVE IT OR NOT, WE SOMETIMES GET FIREARMS BACK THAT ARE LOADED!!!

 **WARNING: NEVER SHIP LIVE AMMUNITION OR SPENT CASES WITH ANY FIREARM THAT YOU ARE RETURNING TO ARMALITE® FOR SERVICE. IT IS ILLEGAL TO DO SO!**

 **WARNING: IT IS THE OWNER'S RESPONSIBILITY TO ASSURE THAT ANY PARTS THAT ARE PURCHASED FROM ARMALITE® ARE CORRECTLY FITTED AND INSTALLED. IMPROPER FITTING OR INSTALLATION MAY RESULT IN INJURY, DEATH, OR DAMAGE/MALFUNCTION OF THE FIREARM.**

5. Package the firearm carefully, inclosing a copy of the letter (and, for warranty repair, a copy of your ATF Form 4473 / bill of sale / sales receipt). Proper packaging and prepaid shipment (including insurance) of a firearm to ArmaLite is the customer's sole responsibility.

6. Write your RMA number on the outside of the box as part of the ArmaLite address. Ship to:

AL, Inc.

Attn: Premier Services

RMA Number: _____

525 E. Pinnacle Peak Rd. Ste 100

Phoenix, AZ 85024

7. Keep your shipping receipt and the serial number of the firearm for your records in case of loss in shipment. ArmaLite will return the firearm to the customer shipping prepaid if the problem was covered under warranty.

8. ArmaLite MUST return the firearm to the person or company that shipped it to us. If no cost is incurred, your rifle will be automatically shipped to the return address. (No phone call.)

If non-warranty work needs to be performed, we will contact you regarding the cost of such repairs and get your approval before beginning any work.

All firearms shipped to you after repair will require an adult signature at your address for proof of receipt.

ArmaLite continually improves the technical specifications and manufacturing techniques of our firearms, which may cause the latest products to look or perform differently from earlier products. The ArmaLite Premier Services Division will update, at your request, earlier firearms to current factory specifications, to the degree possible, at current shop rates. These updates are not generally covered under warranty.

In the very unlikely event that ArmaLite should ever issue a recall of your firearm, ArmaLite will post a notice on the "Contact Us" page of our website, www.armalite.com.

PATENTS & TRADEMARKS

“ArmaLite®, “AR-10®”, and “SPR®”, are registered trademarks of ArmaLite, Inc.

“M-15”, “AR-30™”, “AR-50™”, and other model variants are trademarks of ArmaLite, Inc.

The AR-10® Series Rifles and Carbines (including the SuperSASS™) are protected by U.S. Patents 5,638, 626 and 5,911,173 and 6,044,748.

The M-15™ Series Rifles and Carbines are protected by U.S. Patents 5,911, 173 and 6,044,748.

The AR-30™ and AR-50™ Series Rifles are protected by U.S. Patents 6,487,805 and 6,637,142.

The AR-23 Subcaliber Device for the Mk-19 Grenade Machine Gun is protected by U.S. Patents 5,983,772 and 6,202,533.

The Blank Firing Adapter for the Mk-19 Grenade Machine Gun is protected by U.S. Patent 5,438,907.

Other patents granted or assigned to ArmaLite include:

Weapons Operating System, U.S. Patent 6,591,535

Cartridge for a Firearm, U.S. Patents 6,367,389 and 6,959,647 and 6,976,431 and 7,458,322

Light Weight Weapon Operating System and Cartridge Feed, U.S. Patent 6,591,535

**STAPLE A COPY OF YOUR:
ATF FORM 4473 AND/OR
BILL OF SALE AND/OR
SALES RECEIPT
HERE**

If, in the unlikely event that you'll have a problem with your ArmaLite that requires warranty service, you will need to send a proof of purchase document to ArmaLite with the firearm. We recommend that you staple one or more of the above proof of purchase documents here so that you can readily find it.

If your proof of purchase document does not include the model number and serial number, you may want to record them here.

Model Number: _____

Serial Number: _____