

**SIGSAUER**<sup>®</sup>  
when it counts<sup>®</sup>



**SIGM400**<sup>®</sup>

## **OWNERS MANUAL: HANDLING & SAFETY INSTRUCTIONS**



**READ THE INSTRUCTIONS AND WARNINGS IN THIS MANUAL CAREFULLY BEFORE USING THIS FIREARM; DO NOT DISCARD THIS MANUAL.**

This instruction manual should always accompany this firearm and be transferred with it upon ownership, or when the firearm is loaned or presented to another person.

## **⚠ WARNING – LOCKING DEVICES**

This firearm was originally sold with a key- operated locking device. While it can help provide secure storage for your unloaded firearm, any locking device can fail. All firearms are designed to fire if they are loaded and the trigger is pulled. Therefore, never install the locking device inside the trigger guard or in any way that makes it possible to pull the trigger! Do not leave the keys in the lock.

The ultimate responsibility for secure storage of any firearm must depend upon its owner and his or her individual circumstances. Firearms should be stored unloaded, in a secure location, separate from their ammunition.

---

### **NEVER INSTALL THE LOCKING DEVICE INSIDE THE TRIGGER GUARD**

---

To maximize effectiveness and reduce the chances of malfunction or damage to a firearm, ALWAYS refer to the locking device's manufacturer directions for installation and removal of the device.

## **FIREARMS SAFETY IS YOUR RESPONSIBILITY**

This owner's manual is designed to assist you in learning how to use and care for your SIG SAUER® pistol properly.

Only when you are certain that you fully understand this manual and can properly carry out its instructions, should you practice loading and firing your firearm with live ammunition. Having a firearm in your possession is a full-time job; you cannot guess and you cannot forget. You must know how to use your firearm safely.

If you have any doubts about your ability to handle or use this firearm safely, you should seek supervised instruction. The Sig Sauer Academy<sup>SM</sup> provides all levels of firearms safety and skill training, from beginner to expert. For more information contact:



[www.sigsaueracademy.com](http://www.sigsaueracademy.com) • (603) 610-3400 • Epping, New Hampshire

**SAFETY MUST BE THE FIRST AND CONSTANT CONSIDERATION OF  
EVERY PERSON WHO HANDLES FIREARMS AND AMMUNITION.**

For more information about safety, responsible firearms ownership, and shooting sports, contact:  
National Rifle Association (NRA) of America, 11250 Waples Mill Road, Fairfax, VA 22030-7400  
1-800-672-3888 • [www.nra.com](http://www.nra.com)

## TABLE OF CONTENTS

Topic	Page
Locking Device .....	6
General Safety Information and Mechanical Characteristics.....	10
Basic Rules of Safe Firearms Handling .....	11
1.0 Safety Information.....	10
1.1 Protect your Eyes and Ears.....	12
1.2 Ammunition.....	12
2.0 Mechanical Characteristics and Rifle Theory.....	17
2.1 Rifle Description .....	17
2.1.1 General .....	17
2.1.2 Barrel with Receiver and Gas System .....	17
2.1.3 Bolt and Bolt Carrier Assembly .....	18
2.1.4 Hand Guard .....	19
2.1.5 Lower Receiver and Buttstock Assembly .....	20
2.1.6 Buttstock Operation.....	22

Topic	Page
2.1.7 Trigger Guard Operation . . . . .	26
2.1.8 Sights . . . . .	28
2.1.9 Magazine . . . . .	35
2.2 Technical Specification . . . . .	46
2.2.1 Operation of Fire Control Selector /Safety . . . . .	37
3.0. Handling . . . . .	39
3.1 Important Instructions . . . . .	39
3.2 Loading the Magazine . . . . .	40
3.3 Loading the Rifle . . . . .	41
3.4 Reloading the Rifle (partially loaded magazine in rifle) . . . . .	42
3.5 Reloading the Rifle (empty magazine in rifle) . . . . .	43
4.0 Cycle of Operation . . . . .	44
4.1 Firing . . . . .	44
4.1.1 Unlocking of the Bolt, Extraction, and Ejection . . . . .	45
4.1.2 Cocking of the Hammer . . . . .	46
4.1.3 Chambering and Locking . . . . .	46

Topic	Page
5.0 Unloading . . . . .	47
6.0 Procedures in case of a Stoppage . . . . .	48
6.1 Failure to Fire (Cold Rifle) . . . . .	48
6.2 Failure to Fire (Hot Rifle) . . . . .	49
7.0 Field Strip Disassembly . . . . .	51
7.1 Detailed Disassembly of the Bolt Carrier and Bolt . . . . .	52
7.2 Extractor Removal . . . . .	53
7.3 Hand Guard Removal . . . . .	54
7.4 Removal of Recoil Buffer and Action Spring . . . . .	55
8.0. Cleaning . . . . .	56
8.1 Bore . . . . .	57
8.2 Chamber . . . . .	57
8.3 Bolt . . . . .	58
8.4 Bolt Carrier . . . . .	58
8.5 Action Spring and Receiver Extension . . . . .	58
8.6 Magazine . . . . .	59
9.0. Reassembly . . . . .	60
9.1. Recoil Buffer and Action Spring . . . . .	60

<b>Topic</b>	<b>Page</b>
9.2 Extractor . . . . .	62
9.3 Bolt to Bolt Carrier . . . . .	63
9.4 Bolt Carrier to Upper Receiver . . . . .	66
9.5 Rejoining Upper and lower Receivers. . . . .	67
10.0 Perform a Function Check . . . . .	68
11.0 Lubrication . . . . .	69
12.0 Transportation and Storage . . . . .	71
13.0 Service and Replacement Parts Policy . . . . .	72
14.0 Shipping Firearms for Repair . . . . .	74
15.0 Parts Diagram . . . . .	76
16.0 Parts List . . . . .	77
SIG SAUER Limited Lifetime Firearms Warranty . . . . .	78

---

## **WARNINGS OF GREAT IMPORTANCE ARE FOUND WITHIN THIS MANUAL**

---

Locking Devices	2	Loading	41
Alterations	9	Firing	44
Manual Safety	21	Storage	71
Ammunition	13, 16	Parts Purchasers	73
Lead Exposure	16	Shipping	75
Handling	39		

---

**OTHER CAUTIONS AND WARNINGS APPEAR THROUGHOUT THE MANUAL**

---

## **FIREARMS ARE DANGEROUS WEAPONS**

**READ THE INSTRUCTIONS AND WARNINGS IN THIS MANUAL  
THOROUGHLY AND CAREFULLY BEFORE USING.**



**⚠ WARNING – ALTERATIONS**

This product was designed to function properly in its original condition. Alterations can make it unsafe. Do not alter any part or add or substitute any parts or accessories not manufactured by SIG SAUER Inc.

**DO NOT ALTER ANY FIREARM**

# GENERAL SAFETY INFORMATION AND MECHANICAL CHARACTERISTICS

## 1.0 Safety Information

The safety warnings in this manual are important. By understanding the dangers inherent in the use of any firearm, and by taking the precautions described herein, you can enjoy complete safety in the use of your rifle. Failure to heed any of these warnings may result in serious injury to you or others, as well as severe damage to the firearm or other property. SIG SAUER Inc. shall not be responsible in any manner whatsoever for malfunctioning of the firearm, physical injury or property damage resulting in whole or in part from:

- 1) criminal or negligent discharge;
- 2) improper or careless handling;
- 3) unauthorized modifications;
- 4) defective, improper, hand-loaded, or reloaded ammunition;
- 5) corrosion;
- 6) neglect; or
- 7) other influences beyond our direct and immediate control.

This limitation applies regardless of whether liability is asserted on the basis of contract, negligence, or strict liability (including any failure to warn). Under no circumstance shall SIG SAUER Inc. be liable for incidental or consequential damages, such as loss of use of property, commercial loss, and loss of earnings or profits.

## THE BASIC RULES OF SAFE FIREARMS HANDLING

1. ALWAYS treat every firearm as if it were loaded.
2. ALWAYS be sure the barrel is clear of any obstruction.
3. ALWAYS be sure of your backstop, what lies beyond, and the safety of bystanders before you shoot.
4. ALWAYS use clean, dry, original factory-made ammunition of the proper type and caliber for your firearm.
5. ALWAYS wear ear protection and safety glasses when shooting.
6. ALWAYS carry your firearm so that you can control the direction of the muzzle if you fall or stumble.
7. NEVER shoot at a flat surface or water.
8. DO NOT leave an unattended firearm loaded. Firearms and ammunition should be stored separately, locked if possible, beyond the reach of children, careless adults, and unauthorized users.
9. NEVER allow your firearm to be used by anyone who has not read and understood this operator's manual.
10. DO NOT point any firearm, loaded or unloaded, at any undesired target.
11. NEVER fire your rifle near an animal unless it is trained to accept the noise: an animal's startled reaction could injure it or cause an accident.
12. NEVER drink alcoholic beverages or take drugs before or during shooting, as your vision and judgment could be seriously impaired, making your firearm handling unsafe.

## 1.1 Protect Your Eyes And Ears

Always wear safety glasses and ear plugs or “ earmuff ” type protectors whenever you are shooting. Always make certain that persons close to you are similarly protected. Unprotected eyes may be injured by powder, gas, carbon residue, lubricant, metallic particles, or similar debris which may emanate occasionally from any firearm in normal use. Without ear protection, repeated exposure to shooting noise may lead to cumulative, permanent hearing loss.

## 1.2. Ammunition

1. Use only high quality, original, factory-manufactured ammunition. Do not use cartridges that are dirty, wet, corroded, bent, or damaged. Do not oil cartridges. Do not spray aerosol-type lubricants, preservative, or cleaners directly onto cartridges or where excess spray may flow into contact with cartridges. Lubricant or other foreign matter on cartridges can cause potentially dangerous ammunition malfunctions. Use only ammunition of the caliber for which your firearm is chambered. The proper caliber is permanently engraved on your firearm; never attempt to use ammunition of any other caliber.

2. The use of reloaded, “remanufactured” hand-loaded, or other non-standard ammunition voids all warranties. Reloading is a science and improperly loaded ammunition can be extremely dangerous. Severe damage to the firearm and serious injury to the shooter or to others may result. Always use ammunition that complies with the industry performance standards established by the Sporting Arms and Ammunition Manufacturers’ Institute, Inc. of the United States (SAAMI) or ammunition manufactured to military specifications.

## **⚠ WARNING – AMMUNITION (CARTRIDGE) NOTICE**

SIG SAUER Inc. SPECIFICALLY DISCLAIMS RESPONSIBILITY FOR ANY DAMAGE OR INJURY WHATSOEVER OCCURRING IN CONNECTION WITH, OR AS A RESULT OF, THE USE IN ANY SIG SAUER FIREARM OF FAULTY, NON-STANDARD, “REMANUFACTURED” HAND LOADED (RELOADED) AMMUNITION, OR CARTRIDGES OTHER THAN THOSE FOR WHICH THE FIREARM WAS ORIGINALLY CHAMBERED.

3. Firearms may be severely damaged and serious injury to the shooter or to others may result from any condition causing excessive pressure inside the chamber or barrel during firing. Excessive pressure can be caused by obstructions in the barrel, propellant powder overloads, the use of incorrect cartridges or defectively assembled cartridges. In addition, the use of a dirty, corroded, or damaged cartridge can lead to a burst cartridge case and consequent damage to the firearm and personal injury from the sudden escape of high-pressure propellant gas within the firearm’s mechanism.
4. Immediately stop shooting and check the barrel for a possible obstruction whenever:
  - You have difficulty in, or feel unusual resistance in, chambering a cartridge;
  - A cartridge misfires (does not go off);
  - The mechanism fails to extract a fired cartridge case;
  - Unburned grains of propellant powder are discovered spilled in the mechanism;
  - A shot sounds weak or abnormal. In such cases it is possible that a bullet is lodged part way down the barrel.
  - Firing a subsequent bullet into the obstructed barrel can wreck the firearm and cause serious injury to the shooter or to bystanders.
5. Bullets can become lodged in the barrel:

- If the cartridge has been improperly loaded without propellant powder, or if the powder fails to ignite (ignition of the cartridge primer alone will push the bullet out of the cartridge case, but usually does not generate sufficient energy to expel the bullet completely from the barrel);
- If the bullet is not properly seated in the cartridge case. When such a cartridge is extracted from the chamber without being fired, the bullet may be left behind in the bore at the point where the rifling begins. Subsequent chambering of another cartridge may push the first bullet further into the bore.

6. If there is any reason to suspect that a bullet is obstructing the barrel, immediately unload the firearm and look through the bore. It is not sufficient to merely look in the chamber. A bullet may be lodged some distance down the barrel where it cannot easily be seen.

**IF A BULLET IS IN THE BORE, DO NOT ATTEMPT TO SHOOT IT OUT BY USING ANOTHER CARTRIDGE OR BY BLOWING IT OUT WITH A BLANK OR ONE FROM WHICH THE BULLET HAS BEEN REMOVED. SUCH TECHNIQUES CAN GENERATE EXCESSIVE PRESSURE, WRECK THE FIREARM, AND CAUSE SERIOUS PERSONAL INJURY.**

If the bullet can be removed with a cleaning rod, clean any unburned powder grains from the bore, chamber, and mechanism before resuming shooting. If the bullet cannot be dislodged by tapping it with a cleaning rod, take the firearm to a gunsmith.

7. Dirt, corrosion, or other foreign matter on a cartridge can impede complete chambering and may cause the cartridge case to burst upon firing. The same is true of cartridges which are damaged or deformed.

8. Do not oil cartridges, and be sure to wipe the chamber clean of any oil or preservative before commencing to shoot. Oil

interferes with the friction between cartridge case and chamber wall that is necessary for safe functioning, and subjects the firearm to stress similar to that imposed by excessive pressure.

9. Use lubricants sparingly on the moving parts of your firearm. Avoid excessive spraying of any aerosol gun care product, especially where it may get on ammunition. All lubricants and aerosol spray lubricants in particular can penetrate cartridge primers and cause misfires. Some highly penetrative lubricants can also migrate inside cartridge cases and cause deterioration of the propellant powder; on firing, the powder may not ignite. If only the primer ignites, there is danger that the bullet may become lodged in the barrel.

## **⚠ WARNING – AMMUNITION**



Death, serious injury, and damage can result from the use of wrong ammunition, bore obstructions, powder overloads, or incorrect cartridge components. Always wear shooting glasses and hearing protectors.

### **IMPROPER AMMUNITION DESTROYS FIREARMS**

## **⚠ WARNING – LEAD EXPOSURE**



Discharging firearms in poorly ventilated areas, cleaning firearms, or handling ammunition may result in exposure to lead and other substances known to the state of California to cause birth defects, reproductive harm, and other serious physical injury. Maintain adequate ventilation at all times. Wash hands thoroughly after exposure.

### **SHOOTING OR CLEANING FIREARMS MAY EXPOSE YOU TO LEAD**



## 2.0. Mechanical Characteristics and Rifle Theory

### 2.1 Rifle Description

#### 2.1.1 General

The SIGM400 rifle is a direct impingement rifle with a rotary bolt mechanism capable of semi-automatic or full automatic fire operation. Semi-Automatic is defined as one round being fired each time the trigger is pressed to the rear until the magazine is depleted of ammunition. Full automatic or select fire is defined as a continuous rate of fire beginning with the initial press of the trigger and continuing until either the magazine is depleted of ammunition or the operator releases the trigger, at which time the trigger resets. The rifle is chambered in 5.56x45mm NATO and is compatible with .223 Remington ammunition.

#### 2.1.2 Barrel, Receiver and Gas System

The barrel is mechanically mated to the receiver by means of a barrel nut, and the barrel extension. The flash suppressor if applicable is screwed onto the muzzle end of the barrel via ½ x 28 TPI thread pattern. The front sight housing, which is fitted to the barrel, contains the gas port and the front sight. The upper receiver has an integral M1913 accessory rail for attachment of sights or optics.

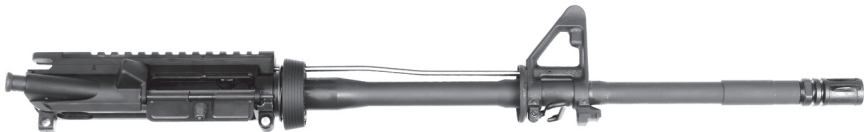

*BARREL WITH RECEIVER AND GAS SYSTEM*

## 2.1.3 Bolt/Bolt Carrier Assembly

The bolt carrier guides the bolt and controls locking and unlocking by means of the cam pin. The bolt carrier incorporates a carrier key that transfers gas from the gas tube to the bolt carrier assembly. The bolt carrier is responsible for cocking the hammer.



*BOLT CARRIER*

The bolt houses the firing pin, the extractor and the ejector. It incorporates locking lugs that lock the bolt into the barrel extension. The cam pin passes into the bolt which allows for locking and unlocking and is retained in the bolt by the firing pin.



*BOLT ASSEMBLY*

## 2.1.4 Hand Guard

The hand guard protects the barrel and the gas system from damage and provides protection from barrel heat.



*HAND GUARD ASSEMBLY ON RIFLE*

## 2.1.5 Lower Receiver Assembly and Buttstock

The lower receiver assembly contains the fire control mechanism, bolt catch, magazine well, magazine release, pistol grip, sling attachment points, and buttstock assembly. The fire control selector is ambidextrous along with the magazine catch. The fire control selector has three positions, SAFE-SEMI-AUTO (depending on model).

SAFE - Trigger is locked and rifle cannot be fired.

SEMI - The rifle will fire one shot with each press of the trigger.

AUTO - Continuous rate of fire beginning with the initial press of the trigger and continuing until either the magazine is depleted of ammunition or the operator releases the trigger, at which time the trigger resets.

### LOWER RECEIVER ASSEMBLY

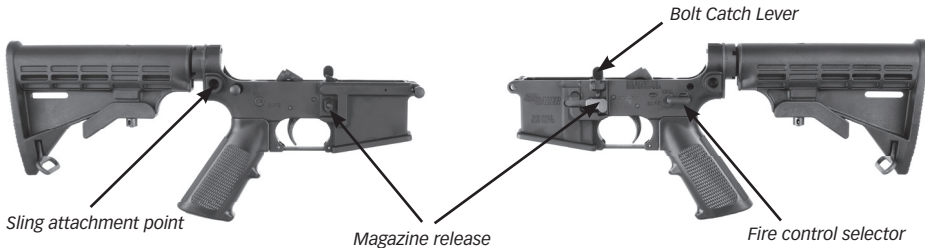



MANUAL SAFETY "ON"



MANUAL SAFETY "OFF"



MANUAL SAFETY "OFF"

*FIRE CONTROL SELECTOR POSITION SAFE-SEMI*

## **⚠ WARNING – MANUAL SAFETY**

Keep the safety "ON" unless actually firing. Always move the safety to its intended position and check it. The safety is not "ON" unless it is completely "ON." Never depend on a safety mechanism or any other mechanical device to justify careless handling or permitting the rifle to point in an unsafe direction. The only "safe" rifle is one in which the bolt is open, the chamber is empty, and there is no magazine in the firearm.

## **KNOW HOW TO USE THE SAFETY**

## 2.1.6 Buttstock Operation

The SIGM400 is equipped with a telescoping buttstock. The buttstock may vary depending on the model. The buttstock on the SIGM400 may vary depending on the specific model you have. The buttstock provides for easy adjustment of the length to accommodate the individual shooter or for storage. To adjust the length of the buttstock, fully depress the release latch and pull the stock rearward to extend or push the stock forward to collapse.

Intermediate positions may be selected by partially depressing the release latch and moving the stock to the desired position.



*BUTTSTOCK*

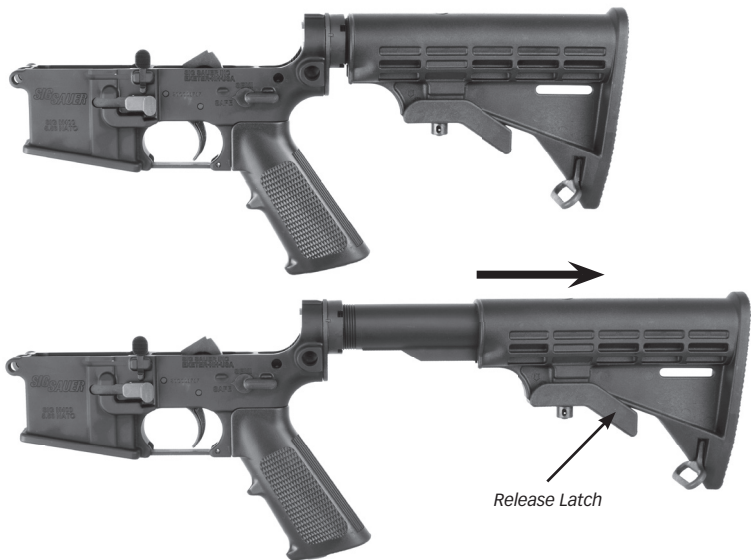

*BUTTSTOCK COLLAPSED AND FULLY EXTENDED*

## To remove the buttstock:

Depress the adjustment lever to disengage the release latch and slide the stock to full extension.

Grasp the release latch and pull down as you slide the stock from the receiver extension.



*BUTTSTOCK REMOVAL*

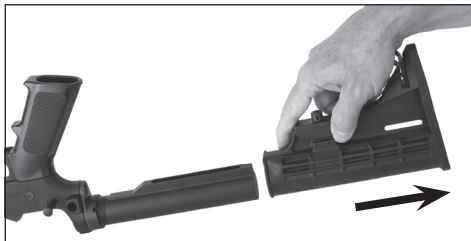



## To re-install the buttstock:

DO NOT FORCE THE PARTS TOGETHER! Align the stock body with the receiver extension and Gently slide the buttstock onto the receiver extension until it stops (About 2 1/8") Grasp the release latch and pull down as you slide the stock the rest of the way on to the receiver extension.

Check to see that the stock moves to all positions locks into place.

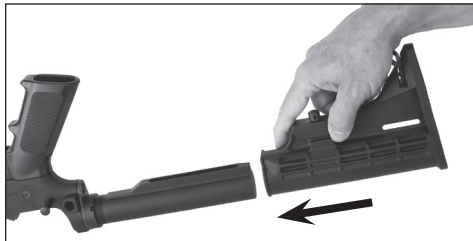

*INSERT VIEW OF BUTTSTOCK INSTALLATION*

## 2.1.7 Trigger Guard Operation

The trigger guard may be released from its normal position to make the trigger accessible for shooting with gloves. For safety reasons the trigger guard must not be released until just before firing the weapon. It should be returned to its normal position immediately.

**⚠ CAUTION: BE CAREFUL WHEN INSERTING GLOVED FINGERS INTO THE TRIGGER GUARD AS ACCIDENTAL DISCHARGES MAY OCCUR!**

To release the trigger guard, depress the spring loaded detent on the front right side and rotate the guard downward.



*TRIGGER AND GUARD RELEASE*

To close the guard rotate the trigger guard back into place, depress the spring loaded detent and ensure the guard locks into place.

**⚠ WARNING**

DO NOT MANIPULATE THE TRIGGER GUARD UNLESS THE FIRE CONTROL SELECTOR IS ON "SAFE" AND THE RIFLE IS UNLOADED.

## 2.1.8 Sights

The SIGM400 rifle features integrated MIL-STD 1913 rails on the upper receiver. These rails may be used for attaching a variety of sighting systems, both optical and fixed. These sights are designed to provide a simple, durable sighting solution should you decide not to use an optical device.



*SIGM400 SIGHT ASSEMBLY*

## Adjustable Rear Sight

**SHORT RANGE** - This "larger aperture is used for 0-200 meters range. As shown, the sight is set for 0-200 meters. This larger aperture is only used when the rear sights all the way down. In other words, the 300-meter mark is aligned with the mark on the left side of the receiver.

*SIGHT ADJUSTMENT FOR 0-200 METERS*



**NORMAL RANGE** -The aperture is unmarked and used for most firing situations. It is used in conjunction with the elevation knob for 300, 400, 500, 600-meter targets.

*SIGHT ADJUSTMENT FOR 300-600 METERS*



## Zeroing your SIGM400

- a The front sight post and rear sight windage knob are adjusted so you can hit your point of aim at 300 meters.
- b The unmarked aperture must be in the up position.
- c. The 300-meter mark is aligned with the mark on the left side of the receiver. This will read 6/3 for the SIGM400.



## Zeroing Adjustments

1. During zeroing procedures, only the front sight post and windage knob are adjusted to move the strike of the bullet on the target.
2. If you are zeroing on a 25-meter range, the rear sight elevation knob is adjusted in accordance to whichever weapon you are using.
3. Detailed zeroing procedures are on the target and the following pages.

**FRONT SIGHT** - The front sight post is moved up or down when zeroing the weapon. Once the weapon is zeroed, the front sight post should not be moved.

To adjust elevation, depress detent and rotate post. To raise strike of bullet, rotate post in the direction of arrow marked UP. Reverse the direction of rotation to lower strike of bullet. Each graduation (notch) moves the point of impact of bullet as indicated.

## Changes in point of impact

FOR ELEVATION (per click) M16A2		
CLICKS	IMPACT	DISTANCE
1	0.9 cm (3/8 in.)	25 meters
2	3.5 cm (1 3/8 in.)	100 meters
3	7.0 cm (2 3/4 in.)	200 meters
FOR WINDAGE KNOB (per click)		
CLICKS	IMPACT	DISTANCE
1	0.3 cm (1/8 in.)	25 meters
2	1.25 cm (1/2 in.)	100 meters
3	2.60 cm (1 in.)	200 meters
4	3.8 cm (1 1/2 in.)	300 meters
5	5.0 cm (2 in.)	400 meters
6	6.3 cm (2 Min.)	500 meters
7	7.8 cm (3 in.)	600 meters

FOR ELEVATION (per click) M4/M4A1		
CLICKS	IMPACT	DISTANCE
1	1.2 cm (1/2 in.)	25 meters
2	4.8 cm (1 7/8 in.)	100 meters
3	9.6 cm (3 3/4 in.)	200 meters
FOR WINDAGE KNOB (per click)		
CLICKS	IMPACT	DISTANCE
1	0.5 cm (3/16 in.)	25 meters
2	1.9 cm (3/4 in.)	100 meters
3	4.8 cm (1 1/2 in.)	200 meters
4	5.7 cm (2 1/4 in.)	300 meters
5	7.6 cm (3 in.)	400 meters
6	9.5 cm (3 3/4 in.)	500 meters
7	11.4 cm (4 1/2 in.)	600 meters



## Zeroing Adjustments (Cont)

To remember your correct zero windage, note location of windage scale and windage knob pointer (heavy mark on outside of knob).

Do not center rear sight aperture for inspections. Keep your correct battle sight zero windage on your weapon at all times.

By following the steps below and establishing a zero at 25 meters, your sights will be set with a 300-meter battlesight.

**NOTE:** Do not move front sight post at this time. It was set at the factory or by a previous shooter and should be very close to your zero.

Center the rear sight aperture by turning the windage knob left or right. (This is called mechanical zero windage.)

1. Position a 25 Meter Zero Target; 25 meters from the firing line.
2. The unmarked long range aperture should be up.
3. Rotate elevation knob in the down direction (counter-clockwise). The elevation knob should stop on the 300-meter mark (6/3). The rear sight should be all the way down on the last whole "click" before it bottoms out. This is called mechanical zero elevation for the rear sight. If your range scale will not line up in the above manner, an armor will be required to adjust the range scale for you.

4. Now rotate the elevation knob clockwise (up) two clicks for the SIGM400 rifle. The elevation knob should remain aligned on the 300 meter setting for the SIGM400 carbine. Any further corrections required in elevation are made to the front sight post only.
5. Aim at target center. Adjust front sight and rear windage to move shot group center as close as possible to the white dot in the center of target.
6. If your shot group is not in the center of the bull's eye, use the squares on the target sheet to calculate the required "clicks" necessary to move your next shot group into the bull's-eye. (Remember that any changes in elevation are made by moving the front sight post.) The squares are numbered around the edges of the target to equal the number of clicks required to move the shot group to the bull's eye.
7. In order to raise your next shot group, rotate the front sight post clockwise. (One click will move the strike of the bullet one vertical square on the target sheet) In order to lower your next shot group, rotate the front sight post counterclockwise (one click, as above, equals one square). Changes in windage are made with the windage knob. (Three clicks will move the strike of the bullet one horizontal square on the target sheet). In order to move the shot group to the left, turn the windage knob counterclockwise. In order to move the shot group to the right, turn the windage knob clockwise.
8. Carefully aim and fire another group at the center of the target bull's eye.
9. Repeat Steps 6 through 8, if required.
10. If your group is centered, your weapon is now zeroed.

## 2.1.9 Magazine

The SIGM400 rifle ships with (1) one thirty (30) round magazine. The SIGM400 is compatible with most M16/AR15 type magazines.

Aftermarket magazines should always be checked for proper fit and function prior to using them with the SIGM400 rifle.



*10, 20 AND 30 RD MAGAZINE*

## 2.2 Technical Specifications

Specifications are approximate and subject to change.

	20"	16"	14.5"	11.5"
<b>CALIBER</b>	5.56 x 45mm NATO			
<b>OVERALL LENGTH</b>	38.25"	39.5"	38"	34"
<b>LENGTH WITH STOCK COLLAPSED</b>	N/A	36.0"	34.5"	30.5"
<b>OVERALL HEIGHT</b>	7.31"			
<b>BARREL LENGTH W/FLASH SUPPRESSOR</b>	20"	16"	14.5"	11.5"
<b>BARREL CONTOUR</b>	Heavy	Mil-Spec M4 Profile		Heavy
<b>RIFLING LEAD</b>	1 in 8"	1 in 7"		
<b>NUMBER OF GROOVES</b>	6			
<b>MUZZLE BRAKE</b>	N/A	Mil-Spec		
<b>SIGHT RADIUS</b>	14.2"			
<b>WEIGHT WITHOUT MAGAZINE</b>	8.53 lbs	7.2 lbs	6.7 lbs	6.35 lbs
<b>MAGAZINE TYPE</b>	AR-15 Type Aluminum			
<b>MAGAZINE CAPACITY</b>	10	30		
<b>TRIGGER</b>	Mil-STD			
<b>TRIGGER PULL</b>	7.6 lbs			

## 2.2.1 Operation of Fire Control/Safety

Four basic fundamentals of safe firearm handling should be applied during any and all activities described in this manual.

Treat every firearm as if it were loaded.

Always keep the muzzle pointed in a safe direction until ready to shoot.

Keep your finger off of the trigger and out of the trigger guard until ready to fire.

Be aware of your target and what is beyond it.

The SIGM400 is equipped with an ambidextrous fire control selector lever commonly referred to as a “safety lever” which can be manipulated from either the left or right side of the lower receiver. The selector has three (3) positions, SAFE/SEMI/AUTO (depending on model).

SAFE - Trigger is locked and rifle **CANNOT** be fired with a normal press of the trigger.



*FIRE CONTROL SELECTOR ON SAFE*

AUTO – The rifle will fire continuously at the cyclic rate until either the operator releases the trigger or the magazine is depleted of ammunition.

SEMI – The trigger is no longer locked and the rifle **WILL FIRE** one shot with each press of the trigger until either the operator stops firing or the ammunition is expended from the magazine.



MANUAL SAFETY "OFF"



MANUAL SAFETY "OFF"

*FIRE CONTROL SELECTOR ON SEMI-AUTO*

The fire control selector should always be in the SAFE position except when the operator is actually going to fire the rifle, and upon completion of firing.

## 3.0 Handling

### 3.1 Important Instructions

- Before manipulating the weapon, ensure the fire control lever is in the SAFE position and the trigger guard is in the closed position.
- Use only factory-new ammunition which corresponds to the caliber of the weapon.
- During all manipulations of the rifle, point the weapon in a safe direction.
- Do not place your finger on the trigger until the target has been verified and you intend to shoot.
- Do not load the weapon until immediately before use.
- Unload weapon immediately after shooting is finished.
- Remove the bolt carrier assembly and magazine from the weapon prior to transportation.

#### **⚠ WARNING – HANDLING**

Never carry the rifle loaded with the safety lever in the FIRE position. If dropped or struck with the safety off (FIRE), the rifle may fire. Such a discharge can occur with or without the trigger being directly struck or touched. Never rest a loaded rifle against any object (wall, tree, fence, vehicle, etc.) because there is always the possibility that the rifle will be jarred or slide from its position and fall with sufficient force to discharge. Keep the safety lever on SAFE unless actually firing.

**ANY FIREARM MAY FIRE IF DROPPED**

## 3.2 Loading the Magazine



*SIGM400 MAGAZINE BEING LOADED*

1. Ensure the magazine is the proper type and caliber for the rifle;
2. Place a round between the feed lips and press down- ensure the bullet is facing the front of the magazine;
3. Ensure the cartridges are fully seated to the rear of the magazine by tapping the back of the magazine in the palm of the hand.



### 3.3 Loading the Rifle

1. Ensure the safety lever is in the SAFE position;
2. Insert the magazine and check that it is properly seated;
3. Bolt forward: Pull the charging handle back fully and release; or
4. Bolt locked open: Depress bolt catch fully to release bolt.

#### **⚠ WARNING**



*MAGAZINE BEING INSERTED*

DO NOT LOAD A RIFLE WITH A HOT CHAMBER BECAUSE A ROUND MAY "COOK" OFF (i.e., a round may detonate (fire) unexpectedly just because it is exposed to the heat of the rifle's chamber).

### 3.4 Reloading the Rifle after firing has commenced (partially loaded magazine still in rifle).

1. Place fire control selector on **SAFE**.
2. Keep muzzle pointed in a safe direction and finger out of the trigger guard!
3. Depress magazine catch and remove magazine.



*MAG CATCH BEING DEPRESSED LEFT AND RIGHT SIDE*

4. Insert loaded magazine and ensure it is seated properly.

### 3.5 Reloading the Rifle after firing has commenced (bolt locked open, empty magazine still in rifle).

1. Place fire control selector on SAFE.
2. Keep muzzle pointed in a safe direction and finger out of the trigger guard!
3. Depress magazine catch and remove magazine.
4. Insert loaded magazine and ensure it is seated properly.
5. Release the bolt by either:
  - a. Depressing bolt catch fully releasing the bolt;
  - b. Grasping the charging handle, retracting it slightly and releasing it.



WHEN COMPLETING STEP 5.B ABOVE, RELEASE THE CHARGING HANDLE AND LET IT GO FORWARD UNDER FULL SPRING POWER. DO NOT RIDE THE CHARGING HANDLE FORWARD AS THIS MIGHT CAUSE A FAILURE OF THE CARTRIDGE TO FULLY SEAT INTO BATTERY.

## 4.0 Cycle of Operation

### Ready to Fire Condition

The SIGM400 "Ready to Fire" condition is described as a loaded magazine properly seated into the magazine well, a live cartridge loaded into the chamber, the fire control selector place on "SAFE".

#### **⚠ WARNING – FIRING**



The bolt automatically opens and shuts quickly while firing. Keep face and hands away from it. Hot brass and powder gas is ejected quickly and can burn you. The rifle should be fired from the right shoulder. Always wear shooting glasses and hearing protectors.

#### **BOLT OPENS FAST – HOT BRASS EJECTED**

### 4.1 Firing

#### **Semi-Auto Models (SAFE-SEMI)**

Rotate the fire control selector from the "SAFE" position to the "SEMI" position.

Pressing the trigger rearward releases the hammer causing it to strike the firing pin, impacting the cartridge primer.

## Select Fire Models (SAFE-SEMI-AUTO)

Rotating the fire control selector from "SAFE" to "AUTO" or "SEMI" to "AUTO" will produce a continuous rate of fire beginning with the initial press of the trigger and continuing until either the magazine is depleted of ammunition or the operator releases the trigger, at which time the trigger resets. On "AUTO" releasing the trigger allows the hammer to be captured by the trigger sear and not the disconnect as it would be when in "SEMI-AUTO" mode. Pressing the trigger again will produce a continuous rate of fire until either the magazine is depleted of ammunition or the operator releases the trigger.

**⚠ CAUTION: THE SIGM400 IS A SEMI-AUTOMATIC RIFLE AND WILL AUTOMATICALLY RELOAD THE NEXT CARTRIDGE IN THE MAGAZINE AFTER THE CHAMBERED CARTRIDGE IS FIRED FOLLOWING ONE PRESS OF THE TRIGGER. THE RIFLE WILL NOW BE READY TO FIRE AGAIN ONCE THE TRIGGER IS RELEASED.**

### 4.1.1 Unlocking of Bolt; Extraction & Ejection

1. The gas pressure generated by the burning powder in the cartridge, propels the bullet through the bore of the tube.
2. When the bullet passes the gas port in the barrel a portion of the gas flows up into the gas block and into the gas valve.
3. The gasses then push the bolt carrier assembly to the rear.
4. As the bolt carrier moves rearward the cam pin allows the bolt to rotate to the right and unlock from the barrel extension.
5. As the bolt carrier continues rearward movement the extractor, gripping the right side of the expended cartridge case pulls the case from the chamber.
6. Once the expended case clears the chamber, the ejector located on the left side of the bolt face pushes the case out the ejection port located on the right side of the upper receiver.

## **4.1.2 Cocking of the Hammer**

1. As the bolt carrier assembly continues rearward the bottom surface of the bolt carrier cocks the hammer rearward.
2. The hammer is then captured by the disconnect and held in place.

## **4.1.3 Chambering and Locking**

1. Once the bolt carrier reaches its full rearward travel the buffer and recoil spring force the bolt carrier assembly forward.
2. As the bolt carrier assembly moves forward the next cartridge is stripped from the magazine and loaded into the chamber.
3. The bolt continues forward, rotates to the left, and locks into place.
4. The trigger is released and the hammer moves to its location of engagement with the trigger.
5. The rifle is now ready to be fired again.

## 5.0. Unloading

**ALWAYS MAKE SURE THE MUZZLE IS POINTED IN A SAFE DIRECTION!**

1. Ensure the fire control selector is rotated to the "SAFE" position.
2. Remove the magazine by depressing the magazine catch; and
3. Retract the charging handle locking the bolt carrier assembly to the rear; and
4. Visually and physically inspect the chamber to verify it is empty.

Remember to clear the chamber after the magazine is removed.

Never assume that any firearm is unloaded until you have personally checked it, visually and physically.

After every range session make sure the firearm is unloaded before you leave the range.

### **⚠ WARNING**

Removing cartridges from the magazine does not prevent the rifle from being fired! When there is a cartridge in the chamber and the safety lever is in the FIRE position, the cartridge will discharge if the trigger is pulled. It is absolutely essential for the user to know how to completely unload the rifle.

"Completely" means emptying the magazine and removing a chambered cartridge. The safety lever should always be in the SAFE position when the rifle is being unloaded.

**THE RIFLE WILL FIRE EVEN IF THE MAGAZINE IS EMPTY OR REMOVED**

## TO CLEAR A STOPPAGE (JAM)

### 6.0. Procedures In Case of a Stoppage

A “Stoppage” is an interruption in the cycle of operation as depicted in Section 4.0. A stoppage can normally be repaired by the operator by performing one of the following immediate actions described.

#### 6.1. Failure to Fire (Cold Rifle) Trigger is pressed, hammer falls, rifle does not fire.

1. Ensure the magazine is properly seated in the magazine well by applying upward pressure and then pulling down on the magazine.
2. Retract the charging handle all the way back and observe the ejection of the expended case or a live cartridge; and
3. Visually inspect the chamber for any obstructions, if the chamber shows to be clear, release the charging handle to feed a new cartridge. Do NOT ride the charging handle forward.
4. Attempt to fire the rifle again.



## 6.2. Failure to Fire (Hot Rifle) Trigger is pressed, hammer falls, the rifle does not fire.

1. Keep the muzzle pointed down range, place the rifle on SAFE, remove the magazine, if you cannot extract the loaded cartridge within ten (10) seconds you must wait a minimum of 15 minutes before handling the rifle.
2. Upon completion of the 15 minutes, retract the charging handle all the way back and observe the ejection of the cartridge; and
3. Visually inspect the chamber for any obstructions, if the chamber shows to be clear, release the charging handle to feed a new cartridge. DO NOT ride the charging handle forward.
4. Attempt to fire the rifle again.

If the rifle does not fire after completing 6.1 or 6.2:

1. Unload, and clear the rifle.
2. Insert a fresh magazine;
3. Cycle the bolt assembly chambering a round; and
4. Attempt to fire the rifle.

If the rifle fails to fire after attempting all of the above, the rifle should be returned to SIG SAUER, Inc. for evaluation by a factory trained technician.

### **WARNING**

EXCESSIVE HEAT BUILD UP IN THE CHAMBER CAN CAUSE WHAT IS REFERRED TO AS A “COOK OFF”. THIS MEANS THE HEAT IN THE CHAMBER CAUSES THE POWDER TO IGNITE IN THE CHAMBERED CARTRIDGE. THE ROUND THEN DETONATES JUST AS IF IT WERE FIRED. IF THE RIFLE HAS BEEN FIRED FOR AN EXTENDED PERIOD OF TIME FOLLOW THE STEPS IN 6.2.

## 6.4. Feedway Stoppage (Jam)

A feedway stoppage occurs when one or more rounds are trapped in the upper receiver and stop the cycle of operation. To clear this problem:

1. Place the rifle on SAFE.
2. Remove the magazine (You might have to pull downward with some force to remove the magazine from the magazine well due to the jammed cartridges).
3. Cycle the bolt carrier assembly several times to clear any rounds from the receiver; and
4. Lock the bolt carrier to the rear, conduct a visual and physical inspection of the chamber to make sure the chamber has no obstructions; and
5. Insert a fresh magazine and continue to fire the rifle.

**⚠ CAUTION: Always remove the source of ammunition (magazine) prior to attempting to clear a stoppage that requires retracting the charging handle/bolt carrier assembly as unintentional release of the spring loaded bolt carrier assembly could detonate live cartridges lodged in the upper receiver.**

## 7.0. Field Strip Disassembly

1. Unload and clear the rifle per section 5.0.
2. Ensure the bolt carrier assembly is forward and the fire control selector is placed on SAFE.
3. Press the takedown pin from left to right until it stops (It is held into the lower receiver by a detent and will not pull free from the receiver).



4. Press the Pivot Pin (front pin) from left to right until it stops at the detent.
5. Separate the upper receiver from the lower receiver.
6. Grasp the charging handle and pull it rearward until it stops.
7. Remove the bolt carrier assembly from the rear opening of the upper receiver.
8. Align the tabs of the charging handle and lift it from the receiver.

## 7.1. Detailed Disassembly of the Bolt Carrier and Bolt.

1. Remove the firing pin retaining pin from the left side of the bolt carrier. A small punch might be needed for this procedure.
2. Tilt the bolt carrier upward and catch the firing pin as it slides out of the rear of the bolt.
3. Rotate the bolt cam pin  $\frac{1}{4}$  turn and lift it straight up out of the bolt carrier.
4. Pull the bolt out from the front of the bolt carrier.



*BOLT AND BOLT CARRIER*

## 7.2. Extractor Removal

1. Apply slight pressure to the rear of the extractor with the thumb.
2. Using a punch, or the tip of the firing pin, push out the extractor pin. from either side.
3. Remove the extractor from the bolt.



*BOLT WITH EXTRACTOR REMOVED*

**NOTE:** Only separate the extractor spring from the extractor when replacement is necessary

## 7.3. Hand Guard Removal

**⚠ CAUTION: DO NOT REMOVE THE HAND GUARD ASSEMBLY UNLESS THE UPPER AND LOWER RECEIVERS ARE SEPARATED. REMOVAL OF THE HAND GUARD WILL EXPOSE THE GAS TUBE ASSEMBLY. SHOULD THE RIFLE FALL OR STRIKE A HARD SURFACE, THE GAS TUBE COULD BE DAMAGED EFFECTING OPERATION OF THE RIFLE. SEPARATING THE RECEIVERS REDUCES THE OVERALL WEIGHT OF THE RIFLE REDUCING THE RISK OF DAMAGE SHOULD THE RIFLE FALL OR STRIKE A HARD OBJECT OR SURFACE.**



*EXPLODED VIEW OF HAND GUARD*

## 7.4. Removal of Recoil Buffer and Action Spring

REMOVAL OF THE RECOIL BUFFER AND SPRING IS EASIER IF THE HAMMER IS IN THE COCKED POSITION AND THE FIRE CONTROL SELECTOR IS ROTATED TO THE SAFE POSITION. ALWAYS WEAR SAFETY GLASSES WHEN HANDLING PARTS UNDER SPRING TENSION.

1. Depress buffer retaining plunger while maintaining control the buffer as you allow it to move forward from the receiver extension tube.



*THUMB OVER BUFFER ASSEMBLY*

2. Guide the buffer and action spring from the receiver extension.

3. Use a clockwise twisting motion to separate the action spring from the recoil buffer.

Do NOT pull straight back on the action spring as it can cause damage to the spring.

*BUFFER  
AND RECOIL SPRING  
REMOVAL*



## 8.0. Cleaning

1. Your rifle is delivered factory packaged and preserved with a light coating of protective grease and oils. Before loading make certain that all packing grease and oil has been cleaned from the bore and exposed mechanism.
2. Before you begin to disassemble your firearm for cleaning, always double-check to make sure it is unloaded!
3. After cleaning always check to be sure that no cleaning patch or other obstruction remains in the bore or chamber!

ONLY USE CLEANING AND LUBRICATION PRODUCTS THAT ARE SPECIFICALLY DESIGNED FOR USE ON FIREARMS.

DO NOT USE WIRE BRUSHES ON ALUMINUM SURFACES SUCH AS THE RECEIVERS OR QUAD RAILS AS THIS MAY SCRATCH THE FINISH.

READ ALL WARNING LABELS AND OBTAIN MSDS ON ANY CLEANING, LUBRICATION, AND PROTECTIVE CHEMICALS USED.

CLEANER, LUBRICANT, PROTECTANT IS COMMONLY REFERRED TO AS "CLP"

SOME BORE CLEANERS ARE NOT MEANT TO BE LEFT IN THE BORE FOR EXTENDED PERIOD OF TIME.

FOLLOW ALL MANUFACTURER'S INSTRUCTIONS AND CAUTIONS WHEN USING CLEANING OR LUBRICATION PRODUCTS ON FIREARMS.

SOLVENT IS A GENERIC TERM AND WILL BE USED TO DESCRIBE A GENERAL BORE CLEANING SOLUTION.



## 8.1. Cleaning the Bore

1. Run a patch soaked in solvent through the bore.
2. Allow the solvent to soak in the barrel for at least 5 minutes.
3. Move on to section 8.3 and clean the bolt while the solvent works on loosening the residue in the bore of the barrel.
4. If the barrel is heavily fouled use a cleaning rod and a brass or nylon bore brush of the proper bore diameter and clean the bore from the chamber end to the muzzle end. Pass the brush completely out past the muzzle and do not change direction in the bore as the brush can become stuck in the bore.
5. Run cotton patches through the bore until the patches come out clean. The bore and chamber of the barrel may be lightly lubricated with an oily patch if the rifle is to be stored. Upon returning the rifle to service you must remove the oil by running a dry patch through the barrel.

## 8.2. Cleaning Chamber

Keep muzzle pointed upward to keep chamber residue from running down into the cleaned bore.

1. Use a chamber brush coated in solvent to clean chamber.
2. Use a minimum of five (5) plunge strokes and three (3) 360 degree clockwise rotations.
3. Clean residue with cotton patches, swabs or a chamber mop.

### **8.3. Cleaning the Bolt**

A cotton patch or a soft toothbrush and solvent can be used to complete the following steps:

1. Clean all fouling from around the bolt locking lugs.
2. Clean all fouling from bolt body
3. Clean extractor and the extractor slot in the bolt.
4. Use pipe cleaner to clean firing pin channel.

### **8.4. Cleaning the Bolt Carrier**

1. Clean all fouling from bolt carrier body.
2. Clean the bolt channel in the front of the carrier with a brush or cotton swabs.

### **8.5. Cleaning Action Spring and Receiver Extension**

1. Clean with rag and solvent.
2. Wipe dry.

## 8.6. Cleaning the Magazine

Magazines should be cleaned whenever the rifle is cleaned as preventive maintenance.



### MAGAZINE

1. Use a brush to clean inside the body.
2. Clean with a rag and CLP then wipe dry.
3. Clean follower and dry completely.

The magazine body should be kept dry. Any oil or solvent left behind will attract dirt and debris causing undue wear and possibly feeding issues.

## 9.0 Reassembly

### 9.1. Recoil Buffer and Action Spring

1. Slide the action spring over the recoil buffer and snap it into place by using a clockwise twisting motion as you press it forward.



*SPRING TO BUFFER*

2. Insert the action spring into the receiver extension tube.



*ACTION SPRING AND BUFFER  
STARTED INTO RECEIVER EXTENSION*

3. Push the recoil buffer back into the receiver extension until the buffer retaining plunger engages the face of the buffer and holds it into the receiver extension.



*BUFFER HELD INTO RECEIVER  
EXTENSION*

## 9.2. Extractor

1. Fit extractor to bolt body by holding bolt in one hand; and
2. While applying pressure with thumb over the spring end of the extractor, slide extractor pin into hole until ends are flush with bolt body.

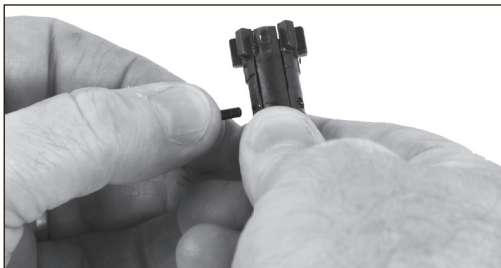

*EXTRACTOR TO BOLT BODY*

### 9.3. Bolt to Bolt Carrier

#### **⚠ WARNING**

THE BOLT CAM PIN MUST BE INSTALLED OR THE RIFLE WILL SUFFER A CATASTROPHIC FAILURE WHICH COULD RESULT IN SERIOUS INJURY OR DEATH TO THE OPERATOR.

DO NOT INTERCHANGE BOLT ASSEMBLIES FROM ONE RIFLE TO ANOTHER. DOING SO COULD RESULT IN SERIOUS INJURY OR DEATH TO THE OPERATOR.

1. Re-insert the bolt into the bolt carrier with the extractor oriented to the right side of the bolt carrier; and

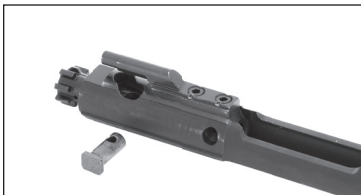

*ALIGN BOLT INTO CARRIER BODY*



2. Pull the bolt forward to the unlocked position; and align the cam pin hole inserting the cam pin into the bolt; and
3. Insert the firing pin into the tail shaft of the bolt.

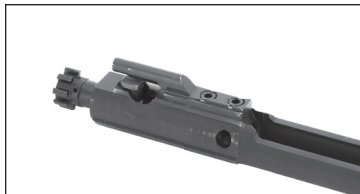

*CAM PIN BACK INTO BOLT AND CARRIER*



**⚠ CAUTION: THE FIRING PIN MUST BE FULLY INSERTED INTO THE BOLT CARRIER PRIOR TO INSTALLATION OF THE FIRING PIN RETAINING PIN. THE RETAINING PIN MUST PASS BETWEEN THE LARGE SHOULDER OF THE FIRING PIN AND THE HEAD OF THE FIRING PIN.**



*FIRING PIN INSERTED INTO BOLT/CARRIER*



4. Re-install the firing pin retaining pin into the bolt carrier from left to right.
5. Point the bolt carrier assembly with the bolt face upward and ensure the firing pin is properly retained in the carrier by lightly slapping the bolt face back into the carrier (locked position). The firing pin should NOT fall out of the carrier.

## 9.4. Bolt Carrier Assembly to Upper Receiver

1. Position the upper receiver assembly with the open bottom facing upward; and
2. Insert the charging handle into the slotted key way of the receiver and push it forward slightly.
3. Take the bolt carrier assembly with the bolt pulled completely forward (unlocked position) and set it into the charging handle.
4. Simultaneously push the bolt carrier assembly and the charging handle forward until the bolt and the charging handle lock into place.

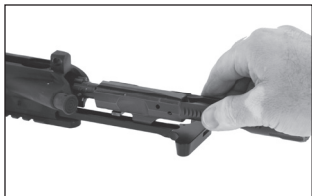

*REINSTALLATION OF THE BOLT CARRIER ASSEMBLY TO UPPER RECEIVER*

## 9.5. Rejoining Upper and Lower Receivers

To aid in steps 1-3, manually cock the hammer by pushing it down until it is held in place then rotate the fire control selector to SAFE.

1. Position the upper and lower receivers to align the pivot pin (front pin) holes.
2. Push the pivot pin from right to left until the head of the pivot pin is flush against the receiver. You will feel it captured by the detent pin.
3. Close the receivers together and push the takedown pin (rear pin) from right to left until the head of the takedown pin is flush against the receiver. You will feel it captured by the detent pin as you did the pivot pin.

## 10.0. Perform a Function Check of the SIGM400 Semi-Automatic Rifle

With the SIGM400 rifle and one UNLOADED magazine perform a function check of the rifle as outlined below in steps 1-13.

THE FUNCTION CHECK SHOULD ALWAYS BE DONE AFTER CLEANING AND ASSEMBLING THE RIFLE. ALWAYS VISUALLY AND PHYSICALLY CLEAR THE FIREARM FIRST!  
SIGM400 (SAFE/SEMI ONLY)

1. Insert an empty magazine into the magazine well until it locks into place.
2. Pull down on the magazine to ensure it is locked in place by the magazine catch.
3. Pull charging handle fully back then push it forward into locked position. The bolt carrier should now be held to the rear by the bolt catch.
4. Depress the magazine catch .
5. The magazine should fall free of the rifle under its own weight (unloaded).
6. Push the top of bolt catch to release the bolt carrier. The bolt carrier will travel forward into the locked position.
7. Rotate the fire control selector to SAFE.
8. Press the trigger to the rear. The hammer should NOT fall.
9. Rotate the fire control selector to SEMI.
10. Press the trigger to the rear and DO NOT RELEASE IT. You should hear a loud click as the hammer falls. Keep the trigger pressed to the rear; and
11. Pull the charging handle to the rear and release it while keeping trigger pulled. Hammer should not fall but be held in the cocked position by the disconnect.
12. Release the trigger. A click should be heard as the hammer is caught by the trigger sear.
13. Press the trigger to the rear again and the hammer should fall.

## 11.0 Lubrication

Using lubricant designed for use on firearms, lightly apply to the contact areas of the following components:

### Upper Receiver Assembly

- Forward assist.
- Ejection port cover spring and latch.
- Charging handle latch and spring.
- Front sight detent.
- Rear sight windage screw and detent.

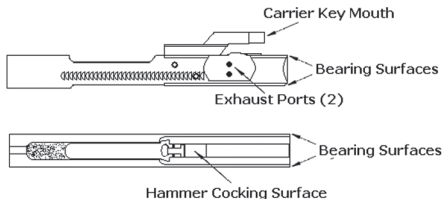

## Bolt and Carrier Assembly

- Extractor spring.
- Tailshaft
- Cam Pin.
- Bolt Rings.
- Locking Lugs.
- Rail Surfaces, top and bottom.
- Bolt bearing surface.

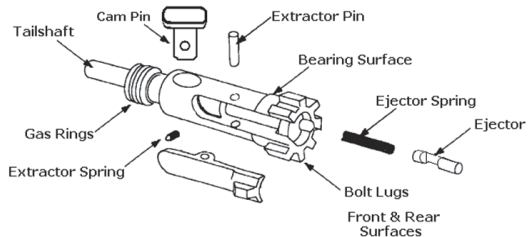

## Lower Receiver Assembly

- Fire control springs, pins, detents, pivot and takedown pins.
- Trigger Sear Surface, Disconnect Surface.
- Buttstock release levers.
- Recoil buffer
- Action spring
- Receiver extension

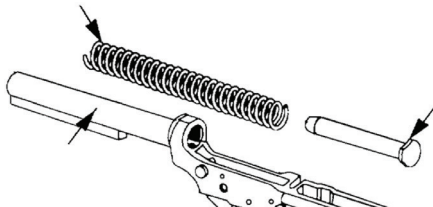

## 12.0 Transportation and Storage

When transporting your firearm to and from shooting activities, keep it unloaded for your safety and for the safety of others. When storing your firearm, keep it separated from ammunition, under lock and key if possible, and out of the reach of children and other inexperienced or unauthorized persons.

### **⚠ WARNING – STORAGE**

Never place or store any firearm in such a manner that it may be dislodged. Firearms should always be stored securely and unloaded, away from children and other unauthorized users. Use the locking device originally supplied with this firearm for storage. The use of a locking device or safety lock is only one aspect of responsible firearms storage. For increased safety, firearms should be stored unloaded and locked in a location that is both separate from their ammunition and inaccessible to children and any other unauthorized person.

### **STORE SECURELY & UNLOADED**

## 13.0. Service and Replacement Parts Policy

### Parts Policy

Our Service Department maintains a full complement of replacement parts. Even though most gunsmiths have the knowledge, training, and the ability to make necessary repairs to your firearm, the skill and workmanship of any particular gunsmith is totally beyond our control.

Should your firearm ever require service, we strongly recommend that you return it to SIG SAUER Inc. A firearm is a precision instrument and some replacement parts will require individual fitting to ensure correct operation. A wrong part, improper fitting, or incorrect mechanical adjustment may result in an unsafe condition or dangerous malfunction, damage to the firearm, or cause possible serious injury to the shooter or others.

IF ANY PART IS ORDERED WITHOUT RETURNING THE FIREARM TO SIG SAUER Inc., the customer bears full responsibility for ensuring that the part supplied is correct for their particular firearm and is properly installed and fitted by a qualified gunsmith.

SIG SAUER Inc. CANNOT BE RESPONSIBLE FOR THE FUNCTIONING OF ANY FIREARM IN WHICH REPLACEMENT PARTS ARE INSTALLED BY OTHERS.



**⚠ WARNING – PARTS PURCHASE**

It is the purchaser's responsibility to be absolutely certain that any parts ordered from the factory are correctly fitted and installed. Firearms are complicated mechanisms and IMPROPER FITTING OF PARTS MAY RESULT IN A DANGEROUS MALFUNCTION, DAMAGE TO THE FIREARM, AND SERIOUS INJURY TO THE SHOOTER AND OTHER PERSONS. The purchaser and installer of parts must accept full responsibility for the correct adjustment and functioning of the rifle after such installation.

**PARTS MUST FIT CORRECTLY**

## Service Policy

If you have questions concerning the performance or servicing of your rifle, please write or call:

SIG SAUER Inc.

Attention: Customer Service

72 Pease Boulevard, Newington, NH 03801

Phone: (603) 610-3000 ext. 1

Fax: (603) 766-7002

IF YOU DO NOT UNDERSTAND THE INSTRUCTIONS FOR OPERATING YOUR RIFLE, IT IS YOUR RESPONSIBILITY TO CALL OUR CUSTOMER SERVICE DEPARTMENT AT (603) 610-3000 EXT. 1 BEFORE USING YOUR RIFLE.

### 14.0. Shipping Firearms for Repair

Returning Your Firearm For Service In the event you need to return your rifle to the SIG SAUER Service Department, here's what to do:

1. The first step is to contact Customer Service at (603) 610-3000 ext. 1 for an RMA number. This number allows SIG SAUER to track the status of your return from its receipt at SIG SAUER through its return to you. Please do not send your firearm until you obtain an RMA number.
2. Make sure that the chamber and magazine(s) are unloaded and that no ammunition is included with your returned firearm.

3. Package the firearm securely to prevent damage. Enclose a letter which includes your name, street address, daytime phone number, model and serial number, and a detailed description of the problem you have experienced or the work you want performed. With the exception of extra magazines, do not include scopes, mounts, or other accessories.
4. Generally, an individual may ship firearms to the manufacturer for repair or service. Some states and localities, however, prohibit this. If you live in such an area, the firearms must be shipped by and returned to a Federally Licensed Firearms Dealer.
5. Federal law prohibits persons who do not possess a Federal Firearms License from shipping a firearm via the U.S. Postal Service. (Note: any shipment of firearms outside U.S. borders is subject to the export laws of the United States and to the valid laws of the specific country, which you must strictly follow; prior to exporting any firearm you should seek legal counsel.)
6. SIG SAUER is not responsible for any firearm until it is received, nor for damage incurred during shipment.
7. Ship your firearms insured and prepaid (we do not accept collect shipments) to:

SIG SAUER Inc.  
Attention: Service Department  
18 Industrial Drive Exeter, NH 03833

This instruction manual should always accompany this rifle and be transferred with it upon change of ownership.

## **▲ WARNING – SHIPPING**

**BEFORE SHIPPING ANY FIREARM, BE ABSOLUTELY CERTAIN THAT THE FIREARM AND ITS MAGAZINE ARE UNLOADED. DO NOT SHIP AMMUNITION WITH A FIREARM.**

## ORDER PARTS

In the event you want to order parts for your SIGM400 rifle, contact Customer Service at (603) 610-3000 ext. 1. Have available the serial number of your rifle and the part diagram number for the part(s) you wish to order.

### 15.0 Parts Diagram

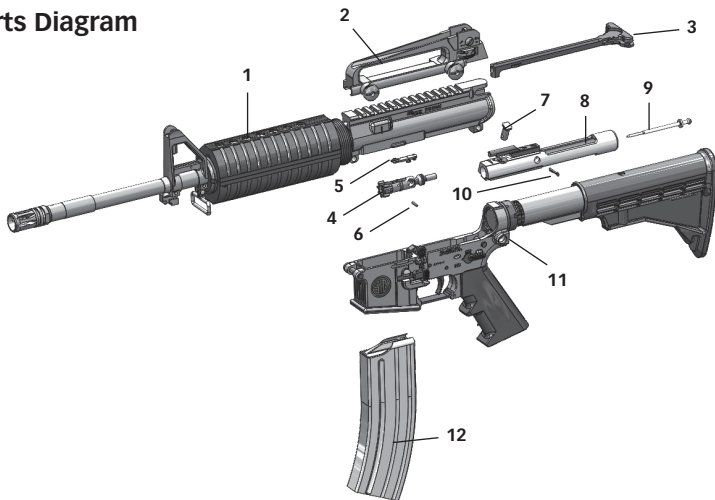

## 16.0 Parts List

No	Description
1	Upper Receiver Group
2	Sight Assembly
3	Charging Handle
4	Bolt
5	Extractor Assembly
6	Extractor Pin
7	Cam Pin
8	Bolt Carrier Assembly
9	Firing Pin
10	Firing Pin Retaining Pin
11	Lower Receiver Group
12	30 rd Aluminum Magazine

## **SIG SAUER® Limited Lifetime Firearms Warranty**

SIG SAUER warrants that the enclosed firearm was originally manufactured free of defects in material, workmanship and mechanical function. For the lifetime of the original purchaser, SIG SAUER agrees to correct any defect in the firearm for the original purchaser by repair, adjustment or replacement, at SIG SAUER's option, with the same or comparable quality components (or by replacing the firearms at SIG SAUER's option); provided, however, that the firearm is returned unloaded and freight prepaid to SIG SAUER at 18 Industrial Drive, Exeter, NH 03833.

This limited warranty is null and void if the firearm has been misused, damaged (by accident or otherwise), fired with handloaded, reloaded or improper ammunition, fired with an obstruction in the barrel, damaged through failure to provide reasonable and necessary maintenance as described in the manual accompanying the firearm, or if unauthorized repair or any alteration, including of a cosmetic nature, has been performed on the firearm. This limited warranty does not apply to normal wear and tear of any parts.

Subject to the foregoing, this limited warranty confers the right to have the covered firearm or its parts repaired, adjusted or replaced exclusively upon the original purchaser, which right is not transferable to any other person. No implied warranties of any kind are made herein and this warranty does not apply to any accessory items attached or appurtenant to the firearm. In no event shall SIG SAUER be liable for any incidental or consequential damages arising from or in connection with this limited warranty.



**SIGSAUER**<sup>®</sup>  
*when it counts*<sup>®</sup>

[www.sigsauer.com](http://www.sigsauer.com)

**FOR PRODUCT SERVICE ON THIS MODEL,  
PLEASE CALL (603) 610-3000 EXT. 1**

72 Pease Boulevard, Newington, NH 03801 USA