



**ORION<sup>®</sup>**  
**OVER/UNDER**  
**SHOTGUNS**

**OWNER'S MANUAL**

**TM**



# INTRODUCTION

Thank you for buying a Weatherby® firearm, and welcome to the family. We realize that you had many products to choose from and hope you feel as we do, that you purchased the finest quality production firearm on the market today.

When my late father started this company in 1945, it was as a means to turn his revolutionary vision of rifle design and cartridge performance into practical realities.

At the time, I'm sure he had little idea that the Weatherby® name would come to be one of the most respected and revered in the firearms industry. That is a level of respect we appreciate, and you have our assurance that it will not be taken for granted.

This Owner's Manual is designed to assist you in learning how to use and care for your Weatherby® Over & Under shotgun. Please read it very carefully and follow all instructions and safety warnings.

In closing, let me assure you that we are committed to the hunter, shooter, and sportsman and delivering the uncompromising craftsmanship, performance, and value that you require in all that we do.

Good Shooting!



# - SAFETY - FIRST AND FOREMOST

FIREARMS ARE DANGEROUS WEAPONS, WHICH CAN CAUSE SERIOUS INJURY OR DEATH. WHEN USING ANY FIREARM, SAFETY MUST BE YOUR FIRST AND CONSTANT CONCERN.

## READ AND UNDERSTAND THE FOLLOWING SAFETY RULES

**KNOW YOUR FIREARM.** Before assembling or using your Weatherby® Over & Under shotgun, read and understand the instructions and safety warnings contained in this Owner's Manual in order to learn how to use the firearm safely and correctly.

**ALWAYS TREAT YOUR FIREARM AS IF IT WERE LOADED.** Use the manual safety slide as outlined in this manual. Never move the safety to "Fire" until YOU are ready to fire.

**KEEP THE MUZZLE POINTED IN A SAFE DIRECTION.** The safe direction may be "up" on some occasions, and "down" on others. Never point the muzzle toward anything not intended as a target.

**USE ONLY THE CORRECT AMMUNITION FOR YOUR FIREARM.** Be sure to use only the correct gauge and length ammunition for your Weatherby® Over & Under shotgun as stamped on the left side of the barrel.

**ALWAYS UNLOAD YOUR FIREARM WHEN NOT SHOOTING.** Never transport or store a loaded firearm in a vehicle or building. Unload your firearm before climbing a fence or obstruction, or entering a slippery area.

**MAINTAIN YOUR FIREARM.** Keep the barrel clean and free of obstructions. Clean your firearm regularly and have it inspected periodically to make sure it is mechanically correct and functioning properly. Worn or damaged parts can be dangerous.

**DO NOT MAKE ADJUSTMENTS.** Never make changes or alterations to your firearm. Use only Weatherby® parts. Do not make any adjustments to the trigger, or change the shape or size of the sear or other parts. Repair should be performed by Weatherby®.

**MAKE YOURSELF SAFE.** Always wear shooting glasses. When target shooting or plinking, use ear protection. If your firearm is equipped with a muzzle brake or is "ported," wear ear protection at all times. Never drink alcoholic beverages before or during shooting.

**REMEMBER - FIREARMS SAFETY DEPENDS ON YOU!!**

# INDEX

• Introduction	Page 3
• Safety - First and Foremost	Page 5
• Index	Pages 6-7
• General Overview	Page 8
• Manual Safety Operation	Page 9
• Ammunition	Page 10
• Multi-Choke Tubes	Page 11
· Removing Choke Tubes	Page 11
· Installing Choke Tubes	Page 12
· Tightening Choke Tubes	Page 12
• Initial Assembly Instructions	Page 13
· Removing Forend from Barrel Assembly	Page 13
· Assembling Barrel to Receiver	Page 13
· Assembling Forend to Receiver Assembly	Page 14
• Operating Instructions	Page 15
· Opening the Breech	Page 15
· Checking for and Clearing Bore Obstructions	Page 15
· Clearing an Obstruction	Page 16
· Closing the Breech	Page 16
· Loading the Shotgun	Page 17
· Barrel Selector	Page 18
· Firing the Shotgun	Page 18
· Unloading the Shotgun	Page 19
• Disassembly Instructions	Page 19
· Disassembly of Barrel from Receiver	Page 19
• Cleaning Your Weatherby® Over & Under Shotgun	Page 19
· Cleaning the Bore	Page 20
· Cleaning the Outside of the Barrel Set	Page 20
· Cleaning Choke Tubes	Page 21
· Cleaning the Receiver and Trigger	Page 21

# INDEX

· Cleaning the Forearm	Page 21
· Cleaning the Buttstock	Page 22
· Rust Prevention and Removal	Page 22
• Storing Your Shotgun	Page 22
• Suggestions for Getting Top Performance from Your Weatherby® Over & Under Shotgun	Page 23
• Exploded View Diagram (general gun assembly) · Parts List	Page 24 Page 25
• Exploded View Diagram (trigger assembly) · Parts List	Page 26 Page 27
• Weatherby® Service Policy	Page 28
• Ten Commandments of Firearms Safety	Page 29
• Exercise Extreme Caution	Page 30

# WEATHERBY® OVER / UNDER SHOTGUN

With proper care as outlined in this manual, your Weatherby® Over & Under shotgun should give you many years of dependable use and shooting pleasure.

The picture below shows the main parts of your Weatherby® Over & Under shotgun. Please refer to it when reading this manual. It will aid in understanding the terminology.



Fig. 1



**LEAD WARNING!**

DISCHARGING FIREARMS IN POORLY VENTILATED AREAS, CLEANING FIREARMS, OR HANDLING AMMUNITION MAY RESULT IN EXPOSURE TO LEAD OR OTHER SUBSTANCES KNOWN TO CAUSE BIRTH DEFECTS, REPRODUCTIVE HARM AND OTHER SERIOUS PHYSICAL INJURY. HAVE ADEQUATE VENTILATION AT ALL TIMES. WASH HANDS THOROUGHLY AFTER EXPOSURE.



# MANUAL SAFETY OPERATION

The manual safety on Weatherby® Over & Under shotgun is a slide-type safety located on the receiver tang behind the top lever. When in proper condition and correctly engaged in the “SAFE” position, the manual safety disengages the sears preventing accidental discharge under normal usage.



## WARNING!!

Never depend on any mechanical safety mechanism or device to prevent the dangers of careless handling or pointing a firearm in an unsafe direction.

When manipulating the manual safety, keep all fingers outside the trigger guard. The shotgun will fire if the trigger is pulled when the safety is not in the “SAFE” position.

The safety should always be in the “SAFE” position except when the shotgun is intended to be fired.

Never Pull the trigger when the safety is in the “SAFE” position.

The manual safety can be moved between the “SAFE” (rearward) and “FIRE” (forward) positions at any time, regardless of whether or not the shotgun is loaded or cocked. ***To minimize the possibility of accidental discharge, it is strongly recommended that the safety always be placed in the “SAFE” position except when the shotgun is intended to be fired.***

To engage the manual safety, move the safety slide rearward with your thumb until it stops and stays in place in the “SAFE” position. The “S” will become visible between the safety slide and top lever (refer to Fig. 2).

To disengage the manual safety, push the slide forward with your thumb until it stops and stays in place in the “FIRE” position. A red dot will become visible below the safety slide.

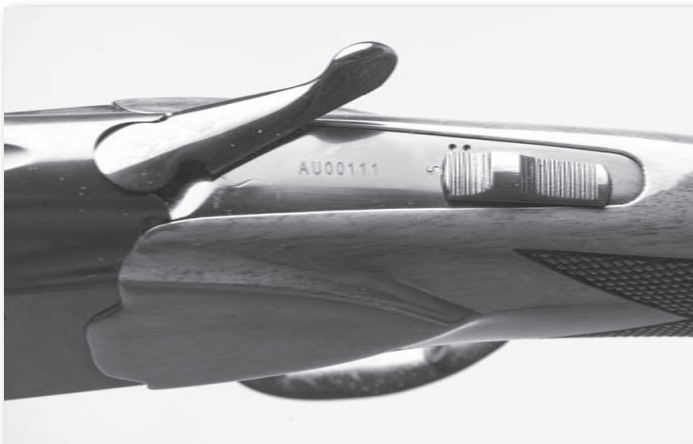

Fig. 2

# AMMUNITION

Weatherby® Over & Under shotguns are chambered for the most popular gauges, shell lengths and loads for which factory-loaded ammunition is manufactured in accordance with U.S. industry standards and is commercially available. Chokes are crafted from high grade steel and certified for steel shot from cylinder bore through modified choke constrictions.

Exercise care to assure that you are using only the correct ammunition for your shotgun. Always make certain that the gauge indicated on the shot shell headstamp matches the gauge marked on the barrel of your shotgun, and also make certain that the shell length indicated on the outside of the shot shell is not longer than the chamber length marked on the barrel of your shotgun.

Gauge and chamber length for each Weatherby® Over & Under shotgun are marked on the side of the top barrel over the chamber.

12 and 20 gauge Weatherby® Over & Under shotguns are chambered for 3" magnum shells, and will safely fire all 2 ¾" and 3" shot shells of the proper gauge.



## WARNING!!

Use of incorrect or overloaded ammunition can result in death or serious injury and damage to your firearm due to excessive pressure. Even the strongest firearm can be "blown up" by excessive pressure. Use only factory-loaded ammunition of the correct gauge and length for your shotgun as marked on the shotgun's barrel.

The accidental chambering and discharge of shells of the wrong gauge or length can result in damage to your gun and possible injury to the shooter. Carry only the proper gauge ammunition with you when shooting. A 20 ga. shell will enter a 12 ga. chamber far enough to leave room for a 12 ga. shell behind it. A damaged gun and possible injury to the shooter or bystanders will result if the gun is fired. Also, a 3½ inch shell will chamber into a 3 inch chamber, but the crimp will unfold into the forcing cone, causing possible unsafe pressures.

Always wear eye and ear protection when shooting.

## AMMUNITION NOTICE

WEATHERBY, INC. SPECIFICALLY DISCLAIMS RESPONSIBILITY FOR ANY INJURY OR DAMAGE WHATSOEVER OCCURRING IN CONNECTION WITH, OR AS A RESULT OF, THE USE OF FAULTY, OR NON-STANDARD, OR "REMANUFACTURED" OR HAND-LOADED (RELOADED) AMMUNITION, OR OF AMMUNITION OTHER THAN FOR WHICH THE FIREARM WAS ORIGINALLY CHAMBERED.

## MULT-CHOKE TUBES

Each new Weatherby® Over & Under shotgun is equipped with interchangeable integral Multi-Choke™ choke tubes and one choke tube wrench (refer to Fig. 3). Two of the choke tubes are installed in the muzzle of the barrels, and the remaining choke tube is packaged in the shipping box.

Weatherby® Multi-Choke™ tubes are crafted from high grade steel and are certified for steel shot from cylinder bore through modified choke constrictions.

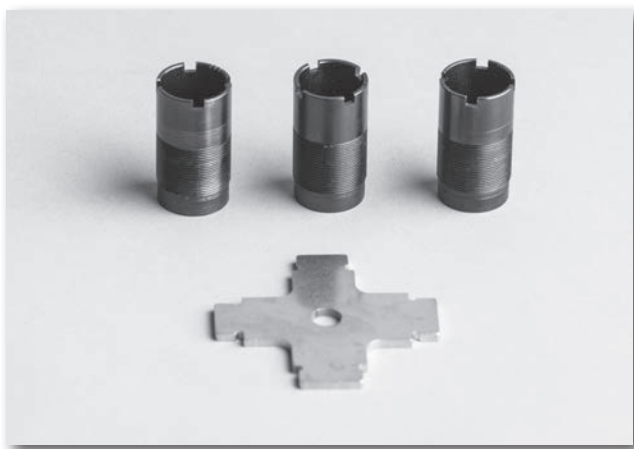

Fig. 3

### REMOVING CHOKE TUBES

Choke tubes may be removed with the barrels disassembled from the shotgun or with the barrels assembled to the shotgun by following these simple instructions. (NOTE: If removing choke tubes with the barrel removed from the shotgun, then begin from instruction no. 3.)

When removing a choke tube from a barrel assembled to the shotgun, keep the muzzle of the shotgun pointed in a safe direction and your fingers out of the trigger guard and away from the trigger at all times.

1. Move the manual safety slide to "SAFE" position (refer to *Manual Safety Operation*, page 9).
2. Unload the shotgun (refer to *Unloading the Shotgun*, page 19).
3. Insert the stepped end of the choke tube wrench into the muzzle of the desired barrel, engaging the notches in the muzzle end of the choke tube.
4. Turn the choke tube counter-clockwise with the wrench until the choke tube emerges from the muzzle sufficiently to grasp with your fingers.
5. Continue turning the choke tube counter-clockwise with your fingers until it is free to be removed from the muzzle.

# INSTALLING CHOKE TUBES

Choke tubes may be installed into a barrel disassembled from the shotgun or with the barrel assembled to the shotgun, by following these simple instructions. **NOTE:** If installing choke tubes with the barrel removed from the shotgun, begin from instruction no. 3.

**When installing a choke tube into a barrel assembled to the shotgun, keep the muzzle of the shotgun pointed in a safe direction, and keep your fingers out of the trigger guard and away from the trigger at all times.**

1. Move the manual safety slide to the "SAFE" position (*refer to Manual Safety Operation, page 9*).
2. Unload the shotgun (*refer to Unloading the shotgun, page 19*).
3. Insert the choke tube into the muzzle of the barrel, and screw it into the barrel as far as possible with your fingers, turning it in a clock-wise direction.
4. Insert the stepped end of the choke tube wrench into the notches in the muzzle end of the choke tube, and continue turning clock-wise until the choke tube is seated, tightening snugly.

**CAUTION:** To prevent damage to barrel or choke tube threads, do not over-tighten.

## TIGHTENING CHOKE TUBES

Choke tubes may loosen with repeated recoil, which may result in changes in point of impact or damage to choke tube or barrel threads with extended use. Check and tighten choke tubes frequently -- before, after and during shooting -- as follows:

**Keep the muzzle of the shotgun pointed in a safe direction, and keep your fingers out of the trigger guard and away from the trigger at all times.**

1. Move the manual safety slide to the "SAFE" position (*refer to Manual Safety Operation, page 9*).
2. Unload the shotgun (*refer to Unloading the Shotgun, page 19*).
3. Insert the stepped end of the choke tube wrench into the notches in muzzle end of choke tube, and tighten the choke tube snugly, turning clock-wise.

**CAUTION:** To prevent damage to barrel or choke tube threads, do not over-tighten.

IDENTIFYING CHOKE TUBE CONSTRICTION			
	IMPROVED CYLINDER (IC)	MODIFIED (MOD)	FULL (FULL)
NOTCH ON TOP	IIII	III	I

**⚠ WARNING!!** Loose choke tubes may cause bore obstructions due to “shaving” shot or preventing a wad from exiting the muzzle, which could result in injury or death to the shooter or bystanders and damage to the shotgun. Tighten choke tubes frequently before, during and after shooting.

## INITIAL ASSEMBLY INSTRUCTIONS

New Weatherby® Over & Under shotguns are packaged in “take down” condition -- the barrel assembly, with the forearm attached, separated from the receiver and buttstock assembly in the shipping carton in which the shotgun is received by the dealer. The shotgun may also have been stored in “take down” condition. Before assembly of the shotgun, the forearm must be removed from the barrel assembly.

### REMOVING FOREND FROM BARREL ASSEMBLY

Remove the forend from the barrel assembly as follows:

1. Depress the forend release button. If the latch does not release, with the other hand squeeze the barrel and forend together and again depress the forend release (*refer to Fig. 4*).
2. The forend will separate from the barrel by allowing the nose of the forend to drop and move forward (*refer to Fig. 5*).



Fig. 4



Fig. 5

### ASSEMBLING BARREL TO RECEIVER

**Keep the muzzle of the shotgun pointed in a safe direction, and keep your fingers out of the trigger guard and away from the trigger at all times.**

1. Visually examine the barrels to make sure there are no shot shells in the chambers or obstructions in the bores, and that all parts are free of dirt and excess oil. (*refer to Checking for and Cleaning Bore Obstructions, page 15*).
2. Remove the forearm from the barrel assembly (*refer to Removing Forend from Barrel Assembly, page 13*).
3. If contact points are dry, put one or two drops of high quality gun oil on the dry contact points as needed (*refer to Fig. 6*).
4. Check the top lever to assure that it is to the far right.

5. With one hand, grasp the receiver and buttstock assembly at the grip, then tuck the buttstock between your body and arm just above the waist while holding the barrel assembly with the other hand.

6. While holding the barrels pointed down at an angle of approximately 45 degrees, place the protruding bosses on the ejectors/extractors into their channels on the front end of the receiver (refer to Fig. 6 & 7).

7. Rotate the muzzle end of the barrels upward until the barrels lock into the receiver and the top lever moves to the center (straight) position.

**⚠ WARNING!!** If ammunition is present in either chamber, the shotgun will be loaded, cocked and will fire by pulling the trigger with the safety "Off" (in the "FIRE" position).

8. Assemble the forend to the barrel assembly (refer to *Assembling forend to Barrel Assembly*, page 14).

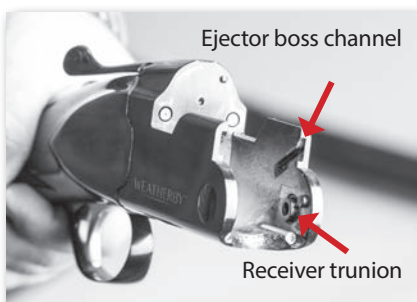

Fig. 6

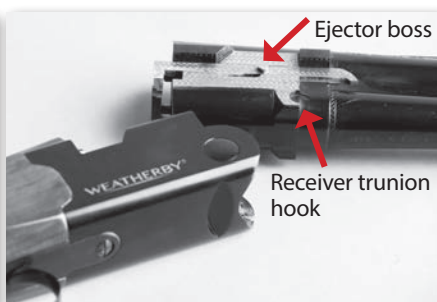

Fig. 7

## ASSEMBLING FOREND TO RECEIVER ASSEMBLY

**Keep the muzzle of the shotgun pointed in a safe direction and your fingers out of the trigger guard and away from the trigger at all times.**

1. Move the manual safety slide to the "SAFE" position (refer to *Manual Safety Operation*, page 9).

2. Unload the shotgun (refer to *Unloading the Shotgun*, page 19).

3. Hold the shotgun by the barrel with the butt of the stock resting on your thigh and the trigger guard up.

4. Position the forend at an angle of approximately 20 degrees in relationship with the barrels, and slide the rear of the forend onto the receiver.

5. Gently pivot the forend onto the barrels, ensuring that the forend is fully seated against the barrels.

# OPERATING INSTRUCTIONS

## OPENING THE BREECH

The top lever controls the locking of the breech of the shotgun. To open the breech:

**Keep the muzzle of the shotgun pointed in a safe direction, and keep your fingers out of the trigger guard and away from the trigger at all times.**

1. Move the manual safety slide to the "SAFE" position (*refer to Manual Safety Operation, page 9*).
2. Hold the shotgun with one hand grasping the buttstock immediately behind the receiver tang, and the other hand firmly grasping the forend.
3. With the thumb of the hand grasping the buttstock, push the top lever to its extreme right position.
4. Using the hand grasping the forend, apply downward pressure to ease the muzzle down until movement of the barrels stops with the breech fully open (*refer to Fig. 8*).

When the breech is fully open, the ejectors will automatically lift any unfired shells for removal from the chamber and eject any fired shells; and the top lever will remain in its extreme right position until the breech is again closed and locked.



Fig. 8

## CHECKING FOR AND CLEARING BORE OBSTRUCTIONS

The barrels of your shotgun should always be checked for obstructions before assembly, before loading and **immediately** following any occurrence in the field which might result in mud, dirt, or other debris entering the bore.

**⚠ WARNING!!** Never attempt to check for or clear a bore obstruction by loading a shot shell into the chamber of the barrel and firing! If there is a bore obstruction this will cause excessive pressures which may result in death or serious injury to yourself or others and damage to your shotgun.

## TO CHECK THE BARREL FOR OBSTRUCTIONS

**Keep the muzzle of the shotgun pointed in a safe direction, and keep your fingers out of the trigger guard and away from the trigger at all times.**

1. Move the manual safety slide to the "SAFE" position (*refer to Manual Safety Operation, page 9*).
2. Open the breech of the shotgun (*refer to Opening the Breech, page 15*).
3. Visually check each bore for obstructions by looking through each barrel from the breech end through the muzzle.

## CLEARING AN OBSTRUCTION

1. Push a shotgun bore cleaning tool through the bore from the breech end until the end of tool exits the muzzle.
2. If the obstruction cannot be easily cleared, contact Weatherby or your local gunsmith.



**WARNING!!** Never load or fire any shotgun which has an obstructed bore. This will cause excessive pressure which may result in death or serious injury to yourself or others and damage to your shotgun.

## CLOSING THE BREECH

**Keep the muzzle of the shotgun pointed in a safe direction, and keep your fingers out of the trigger guard and away from the trigger at all times.**

1. Move the manual safety slide to the "SAFE" position (*refer to Manual Safety Operation, page 9*).
2. Hold the shotgun with one hand grasping the buttstock immediately behind the receiver tang and the other hand firmly grasping the forend.
3. Apply upward pressure with the hand grasping the forend and ease the muzzle up until movement of the barrels stops with the breech fully closed.
4. When the breech is fully closed, the top lever snaps left to the center position, aligned with the safety slide and the muzzle.



**WARNING!!** If a shot shell is in either chamber and the manual safety is not in the "SAFE" position, the shotgun is now ready to fire. Do not touch the triggers until YOU are ready to fire.

5. Visually check the manual safety slide to make certain it is in the "SAFE" position (*refer to Manual Safety Operation, page 9*).





## **WARNING!!**

Use of incorrect or overloaded ammunition can result in death or serious injury and damage to your firearm due to excessive pressure. Even the strongest firearm can be “blown up” by excessive pressure. Use only factory-loaded ammunition of the correct gauge and length for your shotgun as marked on the shotgun’s barrel.

The accidental chambering and discharge of shells of the wrong gauge can result in damage to your gun and possible injury to the shooter. Carry only the proper gauge ammunition with you when shooting. A 20 ga. shell will enter a 12 ga. chamber far enough to leave room for a 12 ga. shell behind it. A damaged gun and possible injury to the shooter will result if the gun is fired. Also, a 3½-inch shell will chamber into a 3-inch chamber, but the crimp will unfold into the forcing cone, causing possible unsafe pressures.

Always wear eye and ear protection when shooting.

## **AMMUNITION NOTICE**

**WEATHERBY, INC. SPECIFICALLY DISCLAIMS RESPONSIBILITY FOR ANY INJURY OR DAMAGE WHATSOEVER OCCURRING IN CONNECTION WITH, OR AS A RESULT OF, THE USE OF FAULTY, OR NON-STANDARD, OR “REMANUFACTURED” OR HAND-LOADED OR RELOADED AMMUNITION, OR OF AMMUNITION OTHER THAN FOR WHICH THE FIREARM WAS ORIGINALLY CHAMBERED.**

### **LOADING THE SHOTGUN**

**Keep the muzzle of the shotgun pointed in a safe direction, and keep your fingers out of the trigger guard and away from the trigger at all times.**

1. Move the manual safety slide to the “SAFE” position (*refer to Manual Safety Operation, page 9*).
2. Open the breech of the shotgun (*refer to Opening the Breech, page 15*).
3. Visually check each bore for obstructions (*refer to Checking for and Clearing Bore Obstructions, page 15*).
4. Place a shot shell of the proper size (*refer to Ammunition, page 10*), and desired type in the chamber of each barrel intended to be fired.
5. Close the breech (*refer to Closing the Breech, page 16*).

 **WARNING!!** If the manual safety is not in the “SAFE” position, the shotgun is now ready to fire. Do not touch the trigger until YOU are ready to fire.

6. Visually check the manual safety slide to make sure it is in the “SAFE” position (*refer to Manual Safety Operation, page 9*).
7. Visually check the top lever to make certain it is in the “Closed” position (*refer to Closing the Breech, page 16*).

## BARREL SELECTOR

Weatherby® Over & Under shotguns are equipped with two barrels and one trigger. A barrel selector is provided to allow you the ability to select the barrel you wish to fire first.

1. The safety slide is also used as a barrel selector. In order to select a particular barrel, the safety slide must be in the "SAFE" position (*refer to Manual Safety Operation, page 9*).
2. To select the bottom barrel, move the selector to the right exposing one dot (*refer to Fig 9*).
3. To select the top barrel, move the selector to the left exposing two dots (*refer to Fig 10*).

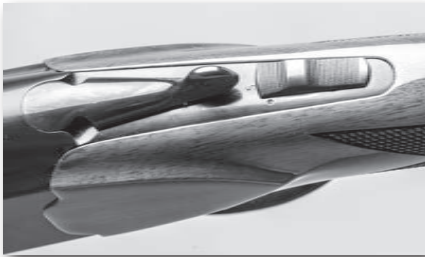

Fig. 9



Fig. 10

## FIRING THE SHOTGUN

**Pulling the trigger fires the shotgun when a shot shell is in the chamber. The Orion has a mechanical trigger, which allows the gun to fire the second loaded chamber on the second pull of the trigger, even if the barrel selected to fire first fails to fire.**

1. With a shot shell in the chamber of the barrel intended to be fired, **and keeping the muzzle of the shotgun pointed in a safe direction and your fingers out of the trigger guard and away from the triggers**, move the manual safety slide to the "FIRE" position. (*refer to Manual Safety Operation, page 9*).
2. Hold the recoil pad snugly to your shoulder and carefully point the muzzle of the shotgun at your intended target.
3. Squeeze (pull) the trigger with steadily increasing pressure until the shotgun fires.

**⚠ WARNING!!** Do not touch the trigger until you are actually ready to fire the shotgun, or an unintended discharge may occur, possibly resulting in death or injury to a bystander, or damage to an unintended target.

4. Unless an immediate second shot is intended, immediately:
  - a. Remove your finger from the trigger;
  - b. Move the manual safety slide to the "SAFE" position (*refer to Manual Safety Operation, page 9*).
  - c. Open the breech of the shotgun (*refer to Opening the Breech, page 15*).

## UNLOADING THE SHOTGUN

**ALWAYS UNLOAD YOUR SHOTGUN IMMEDIATELY AFTER YOU FINISH SHOOTING.**

**Keep the muzzle of the shotgun pointed in a safe direction, and keep your fingers out of the trigger guard and away from the trigger at all times.**

1. Move the manual safety slide to the "SAFE" position (*refer to Manual Safety Operation, page 9*).
2. Open the breech of the shotgun (*refer to Opening the Breech, page 15*).
3. Remove any unfired shot shells from the chambers of both barrels of the shotgun.
4. Visually check each bore for obstructions (*refer to Checking for and Clearing Bore Obstructions, page 15*).

## DISASSEMBLY INSTRUCTIONS

### DISASSEMBLY OF BARREL FROM RECEIVER

**Keep the muzzle of the shotgun pointed in a safe direction, and your keep fingers out of the trigger guard and away from the trigger at all times.**

1. Move the manual safety slide to the "SAFE" position (*refer to Manual Safety Operation, page 9*).
2. Remove the forend from the barrel assembly (*refer to Removing Forend from Barrel Assembly, page 13*).
3. Hold the shotgun with one hand grasping the buttstock immediately behind the receiver tang and the other hand firmly grasping the barrel assembly just forward of the forend lug.
4. With the thumb of the hand grasping the buttstock, push the top lever to its extreme right position and hold. (*refer to Fig 2, page 9*).
5. Applying downward pressure with the hand grasping the barrel assembly, ease the muzzle down until the barrel assembly separates from the receiver and buttstock assembly.

## CLEANING YOUR WEATHERBY® OVER & UNDER SHOTGUN

Any firearm requires regular cleaning and periodic maintenance. To assure safe and reliable functioning of your Weatherby® Over & Under shotgun, it is very important that you clean it immediately after each use and periodically during extended storage periods to remove powder residue, dirt, dust, excess lubricant, and to prevent rust. During cleaning, inspect components to determine whether they are in proper working order.

A basic cleaning kit consists of proper-sized cleaning rod, bore brush(es), patches, gun cleaning solvent, gun lubricant, and lint-free cloths. The cleaning rod must have a tip with a slot into which patches can be inserted. Additionally, toothbrushes, cotton swabs and pipe cleaners are very handy tools for cleaning away dirt in hard to reach places.

To properly clean your shotgun, it must first be disassembled (*refer to Disassembly Instructions, page 19 and Removing Choke Tubes, page 11*), the parts and components cleaned as discussed below, then reassembled.

**CAUTION:** Apply solvents and lubricants properly and sparingly. Do not spray or apply directly on ammunition. Solvents and lubricants may affect the propellant, causing it not to ignite, but the energy from the primer may be sufficient to propel the propellant, wad and shot column into the bore of the barrel, causing an obstruction, and resulting in damage to the shotgun and serious injury to the shooter and bystanders upon firing a subsequent shot shell.

## CLEANING THE BORE

1. With a bore cleaning brush of the proper size attached to the cleaning rod, apply gun cleaning solvent to the brush.
2. Push the brush all the way through each barrel bore several times from the chamber end.
3. Insert the brush into the muzzle of each barrel only far enough to encounter the threads for the choke tube, and twist it several times.
4. With a clean patch inserted in the tip attached to the cleaning rod, push the rod all the way through each barrel bore from the chamber end until the cloth emerges from the muzzle. Remove the dirty patch and withdraw the rod.
5. Repeat step 4 as many times as needed until the patch is clean as it emerges from the muzzle.
6. Using a clean patch or lint-free cloth wrapped around the tip of your finger or similarly shaped object, remove all solvent from the choke tube threads and muzzles of both barrel bores.
7. Insert a patch saturated with gun lubricant into the cleaning rod tip and push it through each bore from the chamber end. Remove the patch and withdraw the rod.
8. Insert a dry, clean patch into the cleaning rod tip and push it through each bore from the chamber end, to remove excess lubricant. Remove the patch and withdraw the rod.
9. Using a clean patch or lint-free cloth wrapped around the tip of your finger or similarly shaped object, apply a light coat of gun lubricant to the choke tube threads and muzzle of both barrel bore.

 **WARNING!!** Excess lubrication in the bore or chamber of any firearm may create excessive chamber pressures or a partial bore obstruction, resulting in possible damage to the firearm and serious injury to the shooter and bystanders upon firing.

**BE SURE ALL EXCESS LUBRICANT HAS BEEN REMOVED.**

## CLEANING THE OUTSIDE OF THE BARREL SET

1. Using a patch or clean cloth saturated with cleaning solvent, wipe down all accessible surfaces of the barrels and rib. (A clean toothbrush may be handy for cleaning the lugs and corners of the barrels.)
2. With a clean, dry, lint-free cloth, remove all cleaning solvent.
3. Using a patch or clean cloth, apply a light coat of gun lubricant to the outside surfaces of the barrels, rib and paying particular attention to the lugs and bearing surfaces on the barrels, being careful to remove any excess lubricant.

## CLEANING CHOKE TUBES

1. Remove choke tubes from barrel (*refer to Removing Choke Tubes, page 11*).
2. With a proper size bore cleaning brush attached to the cleaning rod, apply gun cleaning solvent to the brush.
3. Push the brush all the way through the choke tube several times.
4. With a clean patch inserted in the tip attached to the cleaning rod, push the rod all the way through the choke tube until the patch emerges from the other end. Remove the dirty patch and withdraw the rod.
5. Repeat step 3 as many times as needed until the patch is clean as it emerges from the choke tube.
6. Insert a patch saturated with gun lubricant into the cleaning rod tip and push it through each choke tube. Remove the patch and withdraw the rod.
7. Insert a dry, clean patch into the cleaning rod tip and push it through each choke tube to remove excess lubricant. Remove the patch and withdraw the rod.
8. Using a patch or clean cloth saturated with cleaning solvent, wipe down the outside surfaces of the choke tube. (A clean tooth brush may be handy for cleaning the threads.)
9. With a clean, dry lint-free cloth, remove all cleaning solvent.
10. Using a patch or clean cloth, apply a light coat of gun lubricant to the outside surfaces of each choke tube, being careful to remove any excess lubricant.

## CLEANING THE RECEIVER AND TRIGGER

1. Using a small lint-free cloth, clean the inside and outside of the receiver and trigger with gun-cleaning solvent and dry thoroughly with a clean cloth.
2. With a clean cloth or patch, apply a light coat of gun lubricant to all accessible surfaces of the receiver and trigger.

**NOTE: DO NOT LEAVE AN EXCESSIVE AMOUNT OF OIL ON ANY PARTS, ESPECIALLY THE BREECH SURFACE OF THE RECEIVER. CHECK THE CHAMBERS TO MAKE SURE THEY ARE FREE OF OIL.**

## CLEANING THE FOREARM

1. Wipe the non-metal portions of the forearm with a clean, dry cloth or a silicon cloth.
2. Using a patch or clean cloth saturated with cleaning solvent, wipe down the surface of all metal parts. (A clean toothbrush may be handy for cleaning the lugs, corners and recesses of these parts.)
3. With a clean, dry lint-free cloth, remove all cleaning solvent.
4. Apply a light coat of gun lubricant to the outside surface of the metal parts with a clean cloth or patch.
5. If you have been hunting or shooting in wet weather, allow the forearm to dry thoroughly before storage or reinstallation of the barrel assembly.

## CLEANING THE BUTTSTOCK

Usually, wiping the buttstock with a clean, dry cloth or a silicon cloth is all that is necessary. If you have been hunting or shooting in wet weather, allow the buttstock to dry thoroughly before storage.

## RUST PREVENTION AND REPAIR

During normal maintenance, after a thorough cleaning, allow 2-3 hours at room temperature, for all metal parts to dry completely. Then apply a liberal amount of high grade Gun Oil to all metal parts, wiping off any excess with a clean dry cloth. If rusting does occur it may only be surface rust due to excessive moisture. You may be able to clean it by using a plastic bristle gun cleaning brush and gun cleaning solvent. If you are unable to remove rust on your shotgun, please contact Weatherby® or your local gunsmith. Immediate attention to this problem is imperative to prevent irreparable rust damage.

**DO NOT ALLOW RUST TO GO UNTREATED!**

## STORING YOUR SHOTGUN

Your Weatherby® Over & Under shotgun may be stored fully assembled (*refer to Initial Assembly Instructions, page 13*), or in “take down” condition.

If storing your shotgun fully assembled, release the pressure on the hammer springs as follows:

1. Move the Manual Safety slide to the ‘SAFE’ position (*refer to Manual Safety Operation, page 9*).
2. Open the breech (*refer to Opening the Breech, page 15*) and visually check to make sure no shot shells are in either chamber.
3. Insert “snap caps” in both chambers. (Always use snap caps when releasing the hammers on an empty chamber to prevent damage to the firing pins)
4. Close the breech (*refer to Closing the Breech, page 16*).
5. Move the Manual Safety slide to the ‘FIRE’ position (*refer to Manual Safety Operation, page 9*).
6. Pointing the muzzle of the shotgun in a safe direction, pull the trigger for each barrel (*refer to Barrel Selector, page 18*).

Do not store your shotgun in a leather case, scabbard or foam lined gun case. Leather and foam can attract moisture and cause rusting.

For your safety, and the safety of others, store your shotgun with a lock or other safety device properly installed; and store your ammunition in a separate, locked location.

# SUGGESTIONS FOR GETTING TOP PERFORMANCE FROM YOUR WEATHERBY® OVER & UNDER SHOTGUN

1. Make sure that all screws are tight before firing your shotgun. Loose screws not only contribute to inaccuracy but can cause stock damage. Have screws checked periodically by your local gunsmith as recoil and changes in atmospheric conditions can cause them to work loose.

2. Check and tighten choke tubes frequently -- before, during and after shooting. Choke tube threads may loosen with repeated recoil, which may result in changes in point of impact or damage to choke tube or barrel threads with extended use.

3. The accuracy of any firearm can vary depending upon the brand and type of ammunition used in it. If your shotgun does not exhibit the consistent point of impact and shot pattern you expect, you should try several brands and types of ammunition, after referring to point 1, above, before concluding that it is "inaccurate".

4. If a noticeable change in point of impact should ever occur, and you have checked the above potential sources of inaccuracy, it is possible that there has been a slight dimensional change in the stock due to atmospheric variations. This can happen to any wood stock no matter how well sealed. Contact the Weatherby® Service Department or your local gunsmith.

**DO NOT ALTER THE STOCK IN ANY WAY.** Once a stock has been altered, it cannot be reworked by our Service Department.

5. Consult the factory before returning any product for inspection or repair.



## WARNING

CHILDREN ARE ATTRACTED TO AND CAN OPERATE FIREARMS THAT CAN CAUSE SEVERE INJURIES OR DEATH.

PREVENT CHILD ACCESS BY ALWAYS KEEPING GUNS LOCKED AWAY AND UNLOADED WHEN NOT IN USE. IF YOU KEEP A LOADED FIREARM WHERE A CHILD OBTAINS AND IMPROPERLY USES IT, YOU MAY BE FINED OR SENT TO PRISON.

# GENERAL ASSEMBLY

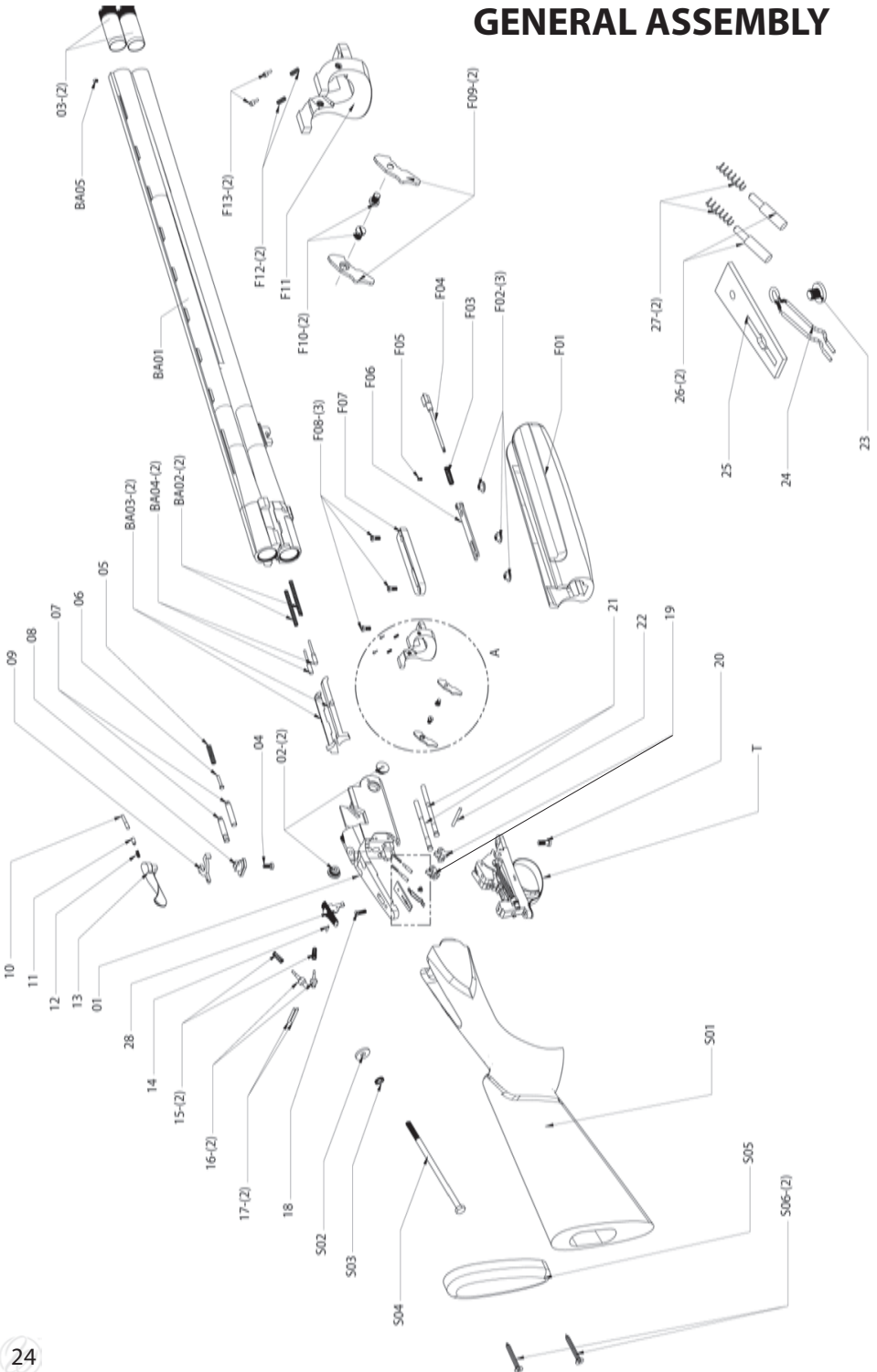



# PARTS LIST

- 01) Receiver
- 02) Screw, Receiver (2)
- 03) Choke Tube (2)
- 04) Screw, Top Lever
- 05) Spring, Pivot Lock
- 06) Plunger, Pivot Lock Spring
- 07) Locking Rods, right
- 07) Locking Rods, left
- 08) Pivot Lock
- 09) Locking Slide
- 10) Pin, Top Lever Plunger Retaining
- 11) Plunger, Top Lever
- 12) Spring, Top Lever
- 13) Top Lever
- 14) Pin, Safety Slide
- 15) Spring, Firing Pin (2)
- 16) Firing Pin, Top
- 16) Firing Pin, Bottom
- 17) Pin, Firing Pin Retaining (2)
- 18) Screw, Trigger Group Top
- 19) Cocking Piece, Right
- 19) Cocking Piece, Left
- 20) Screw, Trigger Group Bottom
- 21) Cocking Rod, Right
- 21) Cocking Rod, Left
- 22) Pin, Cocking Piece
- 23) Screw, Safety Spring
- 24) Spring, Safety
- 25) Safety Plate
- 26) Plunger, Cocking Piece Spring (2)
- 27) Spring, Cocking Piece (2)
- 28) Safety Slide
- BA01) Barrel Set
- BA02) Spring, Ejector (2)
- BA03) Ejector, Left
- BA03) Ejector, Right
- BA04) Plunger, Ejector Spring (2)
- BA05) Front Sight

## Forend Group

- F01) Forend
- F02) Nut, Forend Irons (3)
- F03) Spring, Forend Release Button
- F04) Forend Release Button
- F05) Screw, Forend Release Button
- F06) Forend Locking Slide
- F07) Forend Iron, Front
- F08) Screw, Forend Irons (3)
- F09) Cocking Lever, Right
- F09) Cocking Lever, Left
- F10) Screw, Cocking Lever (2)
- F11) Forend Iron, Rear
- F12) Spring Cocking Lever
- F13) Plunger, Cocking Lever Spring
- S01) Buttstock
- S02) Washer, Buttstock Bolt
- S03) Washer, Buttstock Bolt Lock
- S04) Bolt, Buttstock
- S05) Recoil Pad
- S06) Screw, Recoil Pad (2)
- T) Trigger Group

# TRIGGER GROUP

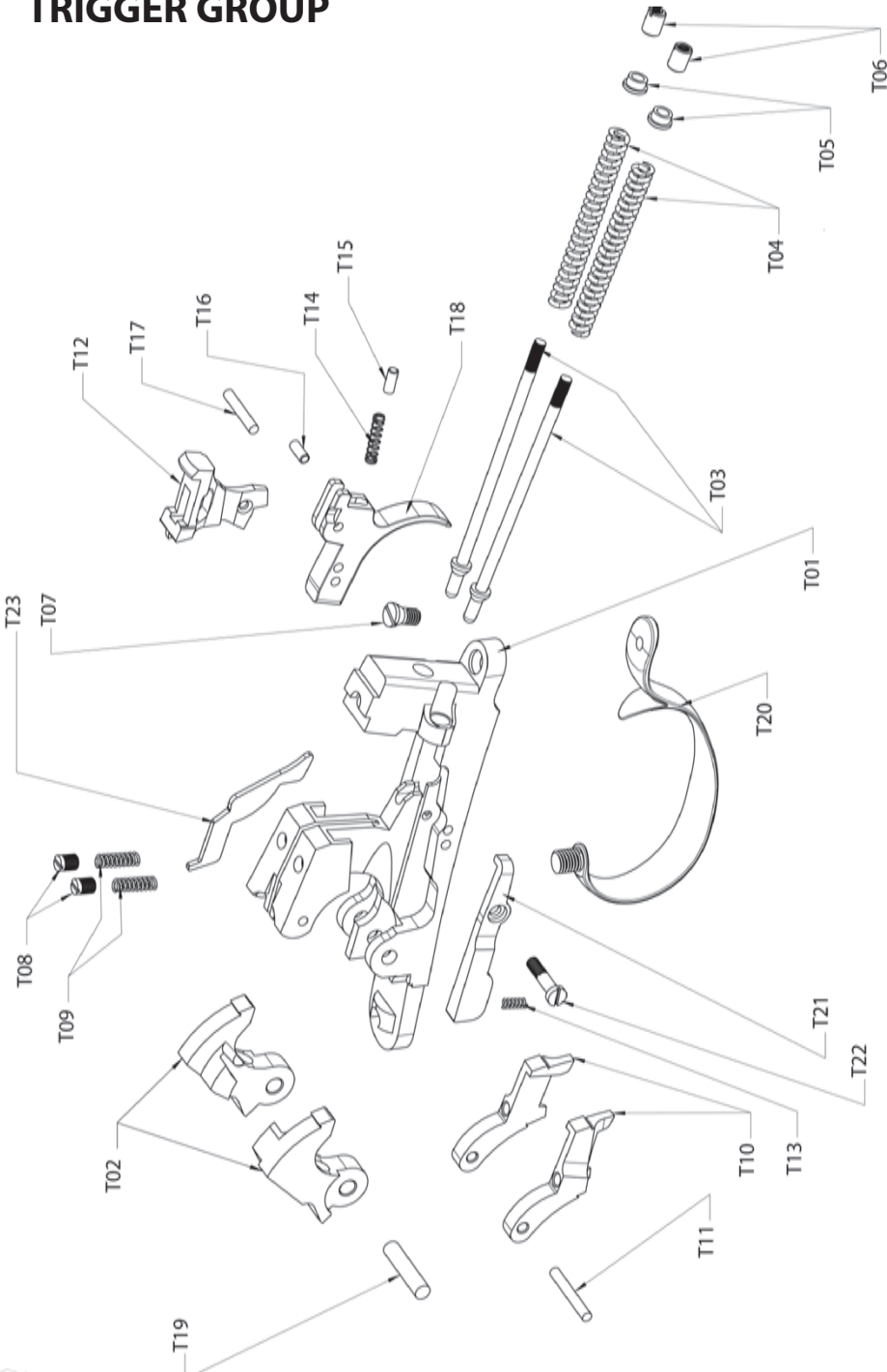

# PARTS LIST

## Trigger Group

- T01) Trigger Group Receiver
- T02) Hammer, Left
- T02) Hammer, Right
- T03) Hammer, Rod (2)
- T04) Spring, Hammer Rod (2)
- T05) Washer, Hammer Rod (2)
- T06) Nut, Hammer Rod (2)
- T07) Screw, Trigger Guard
- T08) Screw, Sear (2)
- T09) Spring, Sear (2)
- T10) Sear, Right
- T10) Sear, Left
- T11) Pin, Sear
- T12) Disconnecter
- T13) Spring, Trigger
- T14) Spring, Disconnecter
- T15) Plunger, Disconnecter Spring
- T16) Pin, Disconnecter
- T17) Pin, Trigger
- T18) Trigger
- T19) Pin, Hammers
- T20) Trigger Guard
- T21) Cross Weight
- T22) Screw, Cross Weight
- T23) Trigger Block

# WEATHERBY SERVICE POLICY

Weatherby is a name that has been synonymous with quality firearms for over 50 years. All Weatherby® firearms are manufactured of the finest materials and have been thoroughly inspected and tested in every phase of production. Because of the confidence we have in our products, Weatherby does not provide a written warranty, but rather stands behind its reputation for customer service and satisfaction.

Simply stated, we will consider requests for service or repair of Weatherby® firearms without charge on a case by case basis. A determination will be made taking into consideration such things as the age and condition of the firearm, and the circumstances surrounding its malfunction or other problem.

Weatherby, Inc. will not be responsible for defects resulting from ordinary wear and tear, alterations by unauthorized persons, accidents, misuse, use of incorrect or other than factory loaded ammunition, or failure to provide reasonable and normal maintenance.

Should any Weatherby® firearm require service or repair under this service policy, it must be delivered transportation prepaid to a Weatherby Authorized Service Center (names and addresses of which can be supplied by Weatherby upon request). The product must be accompanied by a proof of purchase and a letter explaining the problem. It should also be insured by the owner at the time of shipment, as Weatherby, Inc. can accept no responsibility for damage or loss in transit. Weatherby will pay all charges to return the product to the owner if it is accepted for service or repair without charge under the provisions of this service policy. Weatherby, Inc. also reserves the right to repair or replace any product at our sole discretion.

**WEATHERBY, INC. SHALL NOT BE LIABLE FOR ANY CONSEQUENTIAL,  
INCIDENTAL OR CONTINGENT DAMAGES**

**WEATHERBY, INC**  
**1605 Commerce Way Paso Robles, California 93446 (800) 227-2016**  
**[www.weatherby.com](http://www.weatherby.com)**

# TEN COMMANDMENTS OF FIREARMS SAFETY

Prevention is the solution to hunting and shooting casualties. Every hunting and shooting accident that has occurred could have been prevented. Most such accidents happen as a result of people ignoring basic firearms safety rules. Prevention involves knowing and obeying those basic safety rules. Responsible, knowledgeable, and safe hunters and shooters will learn, remember and follow these simple rules:

1. Treat every firearm with the same respect due a loaded firearm.
2. Control the direction of your firearm's muzzle. Carry your firearm safely, keeping the safety on until ready to shoot. Keep your finger off the trigger until ready to shoot.
3. Identify your target and what is beyond it. Know the identifying features of the game you hunt or the targets you intend to shoot.
4. Be sure the barrel and action are clear of obstructions and that you have only ammunition of proper size for the firearm you are carrying.
5. Whenever not in use, keep your firearm unloaded and store all ammunition in a separate location.
6. Never point a firearm at anything you do not want to shoot. Avoid all horseplay with a firearm.
7. Never climb a fence or tree, or jump a ditch or log, with a loaded firearm. Never pull a firearm toward you by the muzzle.
8. Never shoot at a flat hard surface or water. During target practice, be sure your backstop or shot-fall area is adequate.
9. Store firearms and ammunition separately beyond the reach of children and careless adults.
10. Avoid alcoholic beverages or other mood-altering drugs before or while shooting.

## EXERCISE EXTREME CAUTION

### **Heed and follow these additional gun handling warnings whenever using any firearm**

- Be sure the barrel is clear of any obstruction before loading. Make it a habit to check the barrel every time before reloading
- Never place a loaded gun into a vehicle or lean the gun against any object. The gun should be emptied and placed into a case when not in use.
- Keep the safety on at all times. Move the safety to the "FIRE" position only when you are sure that a shot is imminent.
- While loading or unloading, make sure the gun is pointed in a safe direction. Keep your finger off the trigger while operating the action.
- Treat every gun as if it is loaded - it may be!
- If you do not thoroughly understand the proper use and care of your gun, seek the advice of someone you know is competent.
- Do not abuse your hunting privileges. Be respectful of others and other people's property.





# WARNING

CHILDREN ARE ATTRACTED TO AND CAN OPERATE FIREARMS THAT CAN CAUSE SEVERE INJURIES OR DEATH.

PREVENT CHILD ACCESS BY ALWAYS KEEPING GUNS LOCKED AWAY AND UNLOADED WHEN NOT IN USE. IF YOU KEEP A LOADED FIREARM WHERE A CHILD OBTAINS AND IMPROPERLY USES IT, YOU MAY BE FINED OR SENT TO PRISON.



# ADVERTENCIA

A LOS NIÑOS LOS ATRAEN LAS ARMAS DE FUEGO Y LAS PUEDEN HACER FUNCIONAR. ELLOS PUEDEN CAUSARSE LESIONES GRAVES Y LA MUERTE.

EVITE QUE LOS NIÑOS TENGAN ACCESO A LAS ARMAS DE FUEGO GUARDÁNDOLAS SIEMPRE CON LLAVE Y DESCARGADAS CUANDO NO LAS ESTÉ UTILIZANDO. SI USTED TIENE UN ARMA DE FUEGO CARGADA EN UN LUGAR EN QUE UN NIÑO TIENE ACCESO A ELLA Y LA USA INDEBIDAMENTE, LE PUEDEN DAR UNA MULTA O ENVIARLO A LA CARCEL.

PRINTED MARCH 2015  
WEATHERBY, INC

1605 Commerce Way Paso Robles, California 93446 (800) 227-2016  
www.weatherby.com