



**IMPORTANT INSTRUCTIONS FOR**

# **MODEL 1866**

**LEVER-ACTION RIFLES**

---

This owner's manual is for Winchester® Model 1866 lever-action rifles only. Supplemental instructions for special edition Model 1866 rifles must be used in conjunction with the instructions found in this owner's manual. If your supplemental instructions are missing, contact us immediately for a free copy or download one online at [winchesterguns.com](http://winchesterguns.com).

Winchester Repeating Arms  
275 Winchester Avenue  
Morgan, UT 84050-9333  
(800) 945-5237  
[winchesterguns.com](http://winchesterguns.com)

Winchester is a registered trademark of Olin Corporation.

---

# **WINCHESTER**<sup>®</sup>

REPEATING ARMS

Important instructions for the

## Winchester<sup>®</sup> Model 1866 Lever-Action Rifle

**Winchester Repeating Arms**

Customer Service Department (United States)

275 Winchester Avenue

Morgan, Utah 84050-9333

Phone: (800) 945-5237

If you have any questions or comments regarding your new firearm, please feel free to write or call us. Use the space below to record information about your new firearm.

Serial Number \_\_\_\_\_

Caliber \_\_\_\_\_

Grade \_\_\_\_\_

Purchase Price \_\_\_\_\_

Purchased From \_\_\_\_\_

Date of Purchase \_\_\_\_\_

Specifications within this owner's manual are correct at the time of printing and subject to change without notice.

# WINCHESTER®

## REPEATING ARMS

CONTENT	PAGE
State Warning.....	2
WARNING: You Are Responsible for Firearms Safety .....	2
General Description and Operation.....	11
Nomenclature .....	11
Serial Number.....	14
Initial Cleaning and Oiling.....	14
Operation of the Hammer.....	16
Lever Lock .....	19
Ammunition .....	20
Loading .....	21
Firing.....	23
Unloading .....	25
Sight Adjustment .....	26
Cleaning and Maintenance Suggestions.....	28
Parts, Service, Repair and Questions .....	32
Website Information.....	33

With its polished brass receiver, the Model 1866 “Yellow Boy” is the rifle that put Winchester Repeating Arms on the map. The Model 1866 was the choice among cowboys, lawmen, settlers and frontiersmen during the westward expansion of the United States following the Civil War. Compared to other rifles of the day, the Model 1866 was quicker to load and easier to shoot. The Model 1866 later served as the foundation for the immensely popular Model 1873, the rifle that would come to be recognized as “The Gun that Won the West.”

## STATE WARNING

According to state law, California requires that firearm manufacturers, distributors and retailers include conspicuous, specific warnings with firearms sold in that state.

### **WARNING**

Firearms must be handled responsibly and securely stored to prevent access by children and other unauthorized users.

California has strict laws pertaining to firearms, and you may be fined or imprisoned if you fail to comply with them. Visit the Web site of the California Attorney General at <https://oag.ca.gov/firearms> for information on firearm laws applicable to you and how you can comply.

Prevent child access by always keeping guns locked away and unloaded when not in use. If you keep a loaded firearm where a child obtains and improperly uses it, you may be fined or sent to prison.

### **ADVERTENCIA**

Las armas de fuego deben de ser manipuladas responsablemente y almacenadas en sitios seguros para prevenir el acceso a ellas por parte de niños y personas sin autorización.

California cuenta con leyes estrictas sobre las armas de fuego, y puede ser multado y encarcelado si no las obedece. Visite la página web de California Attorney General, <https://oag.ca.gov/firearms> para más información sobre cómo cumplir con las leyes de armas de fuego.

Prevenza el acceso de los niños a las armas de fuego manteniéndolas siempre en un lugar seguro, bajo llave y descargadas cuando no estén en uso. Si usted deja un arma cargada al alcance de un niño, y éste la utiliza indebidamente, usted podría ser multado e incluso enviado a la cárcel.

## WARNING: YOU ARE RESPONSIBLE FOR FIREARMS SAFETY

### **WARNING**

**FAILURE TO FOLLOW ANY OF THE FOLLOWING WARNINGS COULD RESULT IN SERIOUS INJURY OR DEATH.**

As a firearm owner, you accept a set of demanding responsibilities. How seriously you take these responsibilities can be the difference between life and death.

There is no excuse for careless or abusive handling of any firearm. At all times handle this firearm and all other firearms with intense respect for their power and potential danger.

Please read and understand all of the cautions, warnings, notices, proper handling procedures and instructions outlined in this owner's manual before using your new firearm.

**1 ALWAYS KEEP THE MUZZLE OF YOUR FIREARM POINTED IN A SAFE DIRECTION EVEN THOUGH YOU ARE CERTAIN IT IS UNLOADED.**

Never point any firearm at anything you do not intend to shoot. Be extremely alert and aware of all persons and property within the range of your ammunition.

**2 NEVER RELY TOTALLY ON YOUR FIREARM'S MECHANICAL "SAFETY" DEVICE. LIKE ANY MECHANICAL DEVICE, A "SAFETY" CAN SOMETIMES FAIL; IT CAN BE JARRED OR INADVERTENTLY MANIPULATED INTO AN UNSAFE CONDITION.**

The word "safety" describes a firearm's trigger block mechanism, sear block mechanism, hammer block mechanism or firing pin block mechanism. Mechanical "safeties" are designed to place your firearm in a safer status, and no guarantee can be made that the firearm will not fire even if the "safety" is in the on safe position. Mechanical "safeties" merely aid safe gun handling and are no excuse for pointing your firearm's muzzle in an unsafe direction. See "Operation of the Hammer" on pages 16-19 for instructions on the operation of this firearm's hammer.

Remember, safe gun handling does not stop with your firearm's mechanical "safety" devices, it starts there. Always treat this firearm with the respect due a loaded, ready-to-fire firearm.

Some firearms do not have a mechanical "safety." Many target firearms, lever-action firearms and pistols do not have manual "safety" mechanisms. Therefore it is critical to read and understand the owner's manual for every firearm which explains the safe operation of the firearm.

While it is a good idea to test your firearm's mechanical "safety" periodically for proper function, never test the "safety" while your firearm is loaded or pointed in an unsafe direction.

**3 WHENEVER YOU HANDLE ANY FIREARM, OR HAND IT TO SOMEONE, ALWAYS OPEN THE ACTION IMMEDIATELY AND VISUALLY CHECK THE FIREARM'S CHAMBER TO MAKE CERTAIN THAT THE FIREARM IS COMPLETELY UNLOADED.**

Make certain the firearm does not inadvertently contain any ammunition. Remember, merely removing the magazine does not mean the chamber is unloaded. Always keep the chamber empty and the "safety" in the on safe position unless shooting is imminent.

**4 ALWAYS WEAR EAR AND EYE PROTECTION WHEN SHOOTING.**

Unprotected, repeated exposure to gunfire can cause hearing damage. Wear hearing protection (shooting earplugs or muffs) to guard against such damage.

Wear shooting glasses to protect your eyes from flying particles. Allow proper distance (eye relief) between a scope and your eye when firing a scoped pistol, rifle or shotgun. Do not use unorthodox shooting methods that could cause the rearward travel of the slide or bolt of a firearm to contact your eyes, face or hands. Always keep a safe distance between the muzzle of your firearm and any persons nearby, as muzzle blast, debris and ejecting cartridges could inflict serious injury.

Always wear eye protection when disassembling and cleaning any firearm to prevent the possibility of springs, spring-tensioned parts, solvents or other agents from contacting your eyes.

**5 KEEP ALL FIREARMS UNLOADED DURING TRANSPORT, EVEN WHEN STORED IN A HOLSTER, GUN CASE, SCABBARD OR OTHER CONTAINER.**

**6 DROPPING OR JARRING A LOADED FIREARM CAN CAUSE ACCIDENTAL DISCHARGE.**

This can occur even with the "safety" in the on safe position. Be extremely careful while hunting or during any shooting activity to avoid dropping any firearm.

## **7 HUNTING FROM ELEVATED SURFACES SUCH AS TREESTANDS IS DANGEROUS.**

Doing so may increase the risk of mishandling a firearm. The following rules should always be observed by you and those you hunt with. Always make certain that the stand being used is safe and stable. Always make certain that your firearm is unloaded when it is being taken up and down from the stand. Always make certain that your firearm is not dropped from the stand, or dropped while it is being taken up or down from the stand. Remember, a loaded firearm may discharge when dropped, even with the “safety” in the on safe position.

## **8 STORE YOUR FIREARM AND AMMUNITION SEPARATELY, WELL BEYOND THE REACH OF CHILDREN.**

Take prudent safeguards to ensure your firearm does not become available to untrained, inexperienced or unwelcome hands. Store all firearms in secure, locked cases or a gun safe. Keep your firearm unloaded when not in use.

## **9 BEWARE OF BARREL OBSTRUCTIONS.**

Mud, snow and an infinite variety of other objects may inadvertently lodge in a barrel bore. It only takes a small obstruction to cause dangerously increased pressures that can damage your firearm and cause serious injury to yourself and others.

**BEFORE CHECKING FOR A BARREL OBSTRUCTION, BE CERTAIN YOUR FIREARM IS COMPLETELY UNLOADED, THERE IS NOT A LIVE CARTRIDGE IN THE CHAMBER AND THE “SAFETY” IS IN THE ON SAFE POSITION.**

After assuring yourself that the firearm is completely unloaded, open the breech or action and look through the barrel to be sure it is clear of obstructions. If an obstruction is seen, no matter how small it may be, clean the bore with a cleaning rod and patch as described on pages 28-31 of this owner’s manual.

**10 BE ALERT TO THE SIGNS OF AMMUNITION MALFUNCTION. IF YOU DETECT AN OFF SOUND OR LIGHT RECOIL WHEN A CARTRIDGE IS FIRED, DO NOT LOAD ANOTHER CARTRIDGE INTO THE CHAMBER.**

If your firearm fails to fire, keep the muzzle pointed in a safe direction for a minimum of 30 seconds. Carefully rotate the top of the firearm away from you, open the action and remove the cartridge from the chamber. If the primer is indented, the defective cartridge should be disposed of in a way that cannot cause harm. If the primer is not indented, your firearm should be examined by a qualified gunsmith and the cause of the malfunction corrected before further use. Glance down the barrel to make sure that no obstructions remain in the barrel. Completely clear the barrel before loading and firing again. Failure to follow these instructions can cause extensive damage to your firearm and possible serious injury to yourself and others.

**11 NEVER INSERT A CARTRIDGE OF THE INCORRECT CALIBER INTO ANY FIREARM.**

The caliber of your firearm is marked on the barrel. Store all cartridges of different calibers in completely separate and well-marked containers. Never store cartridges of mixed calibers in a common container or in your pockets. See pages 20-21 for more information on the correct ammunition for your firearm.

**12 EXAMINE EVERY CARTRIDGE YOU PUT IN YOUR FIREARM.**

We assume no responsibility for the use of unsafe or improper firearm and ammunition combinations or damage or injury caused by damaged ammunition. It is your responsibility to read and heed all warnings in this owner's manual and on ammunition boxes. See pages 20-21 for more information on the correct ammunition for your firearm.



## **13 USE ONLY SAAMI APPROVED AMMUNITION.**

The barrel and action of this firearm have been made with substantial safety margins beyond the pressures developed by established American commercial loads. Nevertheless, we can assume no liability for incidents which occur through the use of cartridges of nonstandard dimensions or which develop pressures in excess of commercially available ammunition which has been loaded in accordance with standards established by the Sporting Arms and Ammunition Manufacturers' Institute (SAAMI).

## **14 DISCHARGING FIREARMS IN POORLY VENTILATED AREAS, CLEANING FIREARMS OR HANDLING AMMUNITION MAY RESULT IN EXPOSURE TO LEAD AND OTHER SUBSTANCES KNOWN TO CAUSE BIRTH DEFECTS, REPRODUCTIVE HARM AND OTHER SERIOUS PHYSICAL INJURY. HAVE ADEQUATE VENTILATION AT ALL TIMES. WASH HANDS THOROUGHLY AFTER EXPOSURE.**

## **15 DO NOT SNAP THE FIRING PIN ON AN EMPTY CHAMBER; THE CHAMBER MAY NOT BE EMPTY!**

Treat every firearm with the respect due a loaded firearm, even though you are certain the firearm is unloaded.

## **16 KEEP YOUR FINGERS AWAY FROM THE TRIGGER WHILE LOADING AND UNLOADING UNTIL SHOOTING IS IMMINENT.**

## **17 BE SURE OF YOUR TARGET AND BACKSTOP, PARTICULARLY DURING LOW LIGHT PERIODS.**

Know the range of your ammunition. Never shoot at water or hard objects.

**18 ALWAYS UNLOAD YOUR FIREARM'S CHAMBER BEFORE CROSSING A FENCE, CLIMBING A TREE, JUMPING A DITCH OR NEGOTIATING OTHER OBSTACLES.**

Never place your firearm on or against a fence, tree, car or other similar object.

**19 BE DEFENSIVE AND ON GUARD AGAINST UNSAFE GUN HANDLING AROUND YOU AND OTHERS.**

Don't be timid when it comes to firearm safety. If you observe other shooters violating any of these safety precautions, politely suggest safer handling practices.

**20 BE CERTAIN YOUR FIREARM IS UNLOADED BEFORE CLEANING.**

Because so many firearm accidents occur when a firearm is being cleaned, special and extreme care should be taken to be sure your firearm is unloaded before disassembly, cleaning and reassembly.

Keep ammunition away from the cleaning location. Never test the mechanical function of any firearm with live ammunition.

**21 TEACH AND SUPERVISE FIREARMS SAFETY TO ALL MEMBERS OF YOUR FAMILY, ESPECIALLY TO CHILDREN AND NON-SHOOTERS.**

Closely supervise newcomers to the shooting sports. Encourage enrollment in hunting and shooting safety courses.

**22 NEVER DRINK ALCOHOLIC BEVERAGES OR TAKE ANY TYPE OF DRUGS BEFORE OR DURING SHOOTING.**

Your vision, motor skills and judgment could be dangerously impaired, making your gun handling unsafe to you and to others.

**23 READ AND HEED ALL WARNINGS IN THIS OWNER'S MANUAL, ON AMMUNITION BOXES AND WITH ALL ACCESSORIES THAT YOU INSTALL ON YOUR FIREARM.**

It is your responsibility to secure the most up-to-date information on the safe handling procedures of your Winchester firearm. We assume no liability for incidents which occur when unsafe or improper firearm accessories or ammunition combinations are used.

**24 PRACTICE PERIODIC MAINTENANCE, AVOID UNAUTHORIZED SERVICING.**

Your firearm is a mechanical device which will not last forever, and as such, is subject to wear and requires periodic inspection, adjustment and service. Winchester firearms should be serviced by a Winchester Repeating Arms Authorized Service Center or by our Service Facility in Arnold, Missouri. We assume no responsibility for injuries suffered or caused by unauthorized servicing, alterations or modifications of Winchester firearms.

**25 DO NOT, UNDER ANY CIRCUMSTANCES, ALTER THE TRIGGER, “SAFETY” OR OTHER PARTS OF THE FIRING MECHANISM OF THIS OR ANY OTHER FIREARM EXCEPT AS OTHERWISE DESCRIBED IN THIS MANUAL.**

We reserve the right to refuse service on firearms that have been altered, added to or substantially changed. Removal of metal from the barrel, or modifications of the firing mechanism and/or operating parts may lead to a refusal of service on such firearms. You will be charged for parts and labor to return the firearm to original specifications prior to servicing your firearm.

With respect to **AFTERMARKET PARTS OR COMPONENTS** (including, for example, aftermarket trigger systems, barrels, muzzle brakes, suppressors, magazines, etc.), **USE AT YOUR OWN RISK**. Winchester firearms are designed and engineered to meet stringent safety standards. Winchester Repeating Arms is not responsible for personal injuries or property damage caused by alterations to a firearm. This includes the incorporation of aftermarket parts or components that may or may not satisfy Sporting Arms and Ammunition Manufacturers’ Institute (SAAMI) standards (for example, an aftermarket trigger system may not satisfy SAAMI minimum trigger pull standards, etc.) or may create other dangerous conditions. These conditions may or may not be apparent to the user (for example, installing an aftermarket barrel may have the effect of altering critical firearm dimensions, including headspace, and may create an unsafe firing condition, etc.). Aftermarket parts or components that do not satisfy SAAMI standards, or that could create other dangerous conditions, should not be used.

**FAILURE TO FOLLOW THIS WARNING COULD RESULT IN SERIOUS INJURY OR DEATH, AS WELL AS CAUSE DAMAGE TO YOUR FIREARM.**

**BE CAREFUL!**

### GENERAL DESCRIPTION AND OPERATION

---

This Model 1866 rifle is a modern version of the rifle that was carried by hunters, ranchers and lawmen during the westward expansion of the United States. The “Yellow Boy” was affordable, easy to load and shoot. With a few minor exceptions, the action is virtually identical to the way the originals were made in 1866.

Cycling the lever smoothly moves a cartridge from the tubular magazine to the chamber. After firing, working the lever ejects the empty cartridge. Returning the lever upward cycles a new cartridge from the magazine into the chamber.

The Model 1866’s reliable, smooth function made it an instant success in its day. We are sure you will appreciate its incredible design and high level of precision as you become familiar with it by reviewing this owner’s manual.

### NOMENCLATURE

---

Descriptions in this owner’s manual generally refer to the firearm in the horizontal, normal firing position. For example, the muzzle is forward or front; the buttstock is rearward or rear; the trigger is downward or underneath; the sights are upward or on top.

Throughout this owner’s manual the action refers to the mechanism of this rifle which loads and secures the cartridge in the chamber.

Figure 1 (pages 12-13) covers the general features and benefits of the Model 1866 design. The appearance of your rifle may be slightly different, depending on the version you purchased. Refer to Figure 2 (pages 14 and 15) and Figure 3 (page 14) for general part descriptions regarding your new rifle.

You must become familiar with all the part names listed before proceeding with the rest of the instructions in this owner’s manual.

(Continued on page 14)

## FIGURE 1

### MODEL 1866 FEATURES

*This Model 1866 rifle is a replica of one of the original Winchester Repeating Arms designs made over a century ago. The Winchester Model 1866 features a sleek design, precision machining and hand finishing uncommon in most of today's mass produced guns. These are qualities that require more effort during manufacture and provide the lasting beauty and durability you will appreciate for years to come.*



*Inertia striker design.*

*Large hammer is easy to operate.*

*The Model 1866 has a beautiful stock patterned after classic versions popular more than a century ago.*

*Solid brass lifter and dual toggle link action design.*

*Lever lock secures the lever in place.*

# WINCHESTER®

REPEATING ARMS

*Traditional open sights are easily adjustable for elevation and drift adjustable for windage.*

*The tubular magazine loads through a port in the right side of the receiver.*

*Often referred to as the “Yellow Boy” because of its iconic polished brass receiver, the Model 1866 was the rifle that made Winchester Repeating Arms. This accurate, easy to operate lever-action rifle found its way into the hands of settlers, cowboys and frontiersmen as they explored and settled the American West.*

# WINCHESTER®

REPEATING ARMS

**FIGURE 2**

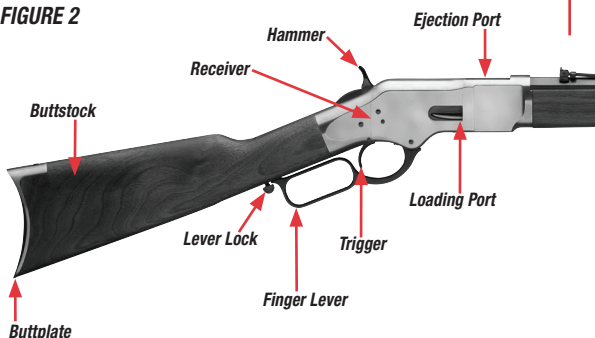

## SERIAL NUMBER

The serial number of your Model 1866 can be found stamped on the bottom of the receiver, under the lever. Record the serial number at the front of this owner's manual for future reference.

## INITIAL CLEANING AND OILING

### **▲WARNING**

**WEAR EYE PROTECTION WHEN ASSEMBLING AND DISASSEMBLING YOUR RIFLE TO PREVENT SPRINGS, SPRING-LOADED PARTS, SOLVENTS OR OTHER AGENTS FROM CONTACTING YOUR EYES, RESULTING IN INJURY.**

**FIGURE 3**

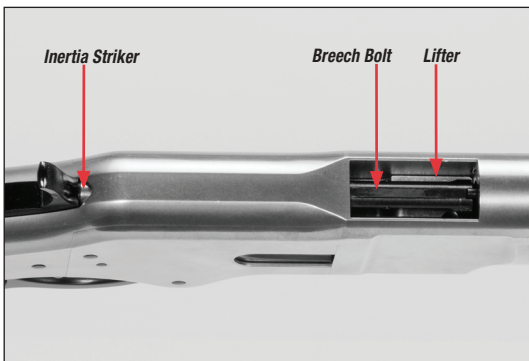



# WINCHESTER®

REPEATING ARMS

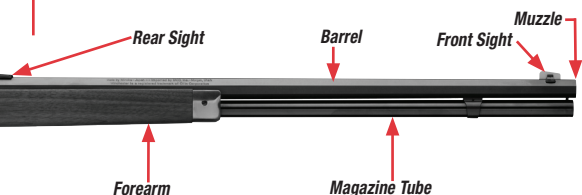

Various exposed metal parts of your new firearm have been coated at the factory with a rust preventative compound. Before firing your rifle, clean the anti-rust compound from the inside of the barrel, receiver and the action-chamber areas. A fine, light gun oil is ideal for removing this compound and for giving your new firearm its first lubrication. However, any quality firearm oil may be used. Clean the barrel using a cleaning rod and patch as explained under “Cleaning and Maintenance Suggestions” on pages 28-31. If your rifle is to be stored, it is acceptable to leave the rust preventative compound on the rifle and keep it in its original packaging.

Before the first firing of your Model 1866 you should first wipe the mechanism completely clean. Clean the

**FIGURE 4**

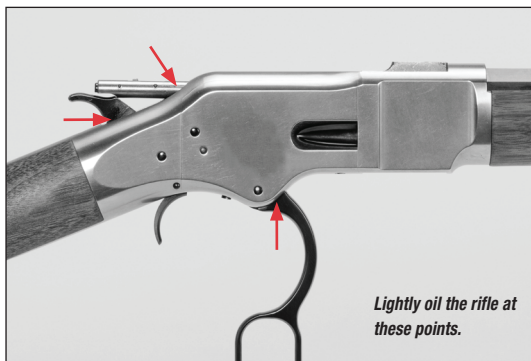

bore and apply a few drops of quality oil on the following surfaces (Figure 4, page 15):

- Along the surface of the striker assembly.
- Along the sides of the hammer.
- On the finger lever pivot between the receiver and the lever.

Avoid applying too much oil. Only a light film is necessary. Cleaning and Maintenance Suggestions should be followed before each oiling.

## OPERATION OF THE HAMMER

### **▲WARNING**

**ALWAYS KEEP THE HAMMER IN THE HALF-COCK POSITION UNLESS SHOOTING IS IMMINENT. ALWAYS KEEP THE MUZZLE POINTED IN A SAFE DIRECTION. FAILURE TO FOLLOW THESE WARNINGS COULD RESULT IN SERIOUS INJURY OR DEATH.**

Like many classic lever-action rifles with an exposed hammer, the Model 1866 does not have a separate manual “safety.”

While you should never rely on the half-cock hammer position to function as a “safety,” the exposed hammer itself is an ideal safety status indicator since it alerts you when the rifle is cocked and ready-to-fire or when the hammer is in the half-cock or dropped position. The hammer has three positions: Full-cock, half-cock, and dropped or fired.

### **FULL-COCK POSITION**

The hammer is in the full-cock position when it is fully to the rear (Figure 5, page 17). At this point, any pull or force on the trigger could allow the hammer to fall, firing the rifle. The hammer can be placed in this position in either of two ways:

- Every time the lever is cycled, the hammer is placed in the full-cock position.
- The hammer may also be placed at full-cock by manually moving it rearward with your thumb until it engages the full-cock notch.

### **▲WARNING**

**WHEN COCKING THE HAMMER WITH YOUR THUMB, BE SURE TO KEEP YOUR FINGERS AWAY FROM THE TRIGGER. ALWAYS KEEP THE HAMMER IN THE HALF-COCK POSITION UNLESS SHOOTING IS IMMINENT. ALWAYS KEEP THE MUZZLE POINTED IN A SAFE DIRECTION. FAILURE TO FOLLOW THESE WARNINGS COULD RESULT IN SERIOUS INJURY OR DEATH.**

### **HALF-COCK POSITION**

The half-cock position (Figure 6, page 17) is the recommended position when carrying the rifle in the field and for storage. Using your thumb, the hammer may be easily and quickly moved to the full-cock position from the half-cock position whenever desired.

### **DROPPED OR FIRED POSITION**

In this position the hammer is fully down (Figure 7, page 17). This is the position of the hammer after a cartridge is fired.

**FIGURE 5**

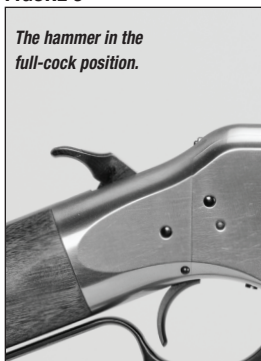

**FIGURE 6**



**FIGURE 7**

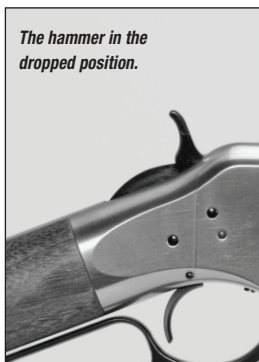

## **▲WARNING**

**THE DROPPED HAMMER POSITION IS NOT A RECOMMENDED HAMMER POSITION WHEN CARRYING, HANDLING OR STORING YOUR RIFLE. ALWAYS KEEP THE HAMMER IN THE HALF-COCK POSITION UNLESS SHOOTING IS IMMINENT. ALWAYS KEEP THE MUZZLE POINTED IN A SAFE DIRECTION. FAILURE TO FOLLOW THESE WARNINGS COULD RESULT IN SERIOUS INJURY OR DEATH.**

### *LOWERING THE HAMMER*

## **▲WARNING**

**WHEN THE TRIGGER IS DEPRESSED, THE HALF-COCK NOTCH WILL NOT CATCH THE HAMMER IF IT SHOULD ACCIDENTALLY SLIP DURING THIS OPERATION.**

**ALWAYS KEEP THE HAMMER IN THE HALF-COCK POSITION UNLESS SHOOTING IS IMMINENT. ALWAYS KEEP THE MUZZLE POINTED IN A SAFE DIRECTION.**

**NEVER USE A HAMMER EXTENSION (HAMMER SPUR) ON YOUR MODEL 1866. USING A HAMMER EXTENSION CAN RESULT IN A MALFUNCTION AND POSSIBLY CREATE A HAZARDOUS CONDITION.**

**FAILURE TO FOLLOW THESE WARNINGS COULD RESULT IN SERIOUS INJURY OR DEATH.**

In order to move the hammer from full-cock to the half-cock position, the trigger must be depressed briefly to initiate the forward travel of the hammer. A little practice with the rifle unloaded will enable you to become adept at using your thumb in this manner. If a cartridge has already been chambered, you need only thumb the hammer back to its full-cock position to prepare the rifle for firing. Otherwise, operate the lever in the usual manner to cock the rifle and feed a cartridge from the magazine into the chamber.

When lowering the hammer to the half-cock position, perform the following recommended procedure:

1. Place the point of the thumb in the “V” space between the hammer and the inertia striker so

**FIGURE 8**

*Hold the hammer firmly and pull the trigger.*

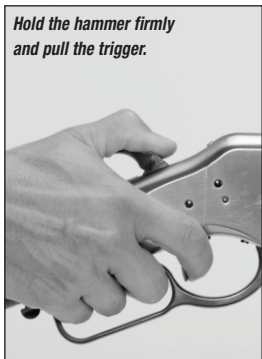

**FIGURE 9**

*Carefully lower the hammer to the half-cock position.*

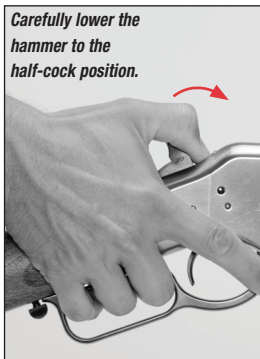

that it can act as a cushion against accidental hammer fall (Figure 8, page 19). The thumb can be easily withdrawn as the hammer approaches the half-cock position. When a scope is mounted on the rifle, it is necessary to insert the tip of the thumb from the side.

2. While firmly holding the hammer with your thumb, squeeze the trigger to release the hammer.
3. Remove your finger from the trigger and slowly ease the hammer to the half-cock position (Figure 9, page 19).

### **LEVER LOCK**

Like the original rifles, the Model 1866 includes a lever lock that secures the lever in the up position (Figure 10, page 20). With the lever lock in the locked position, the lever cannot be cycled. To unlock the lever lock, turn it 90° to the right or left (Figure 11, page 20).

### **ADDITIONAL SAFETY INFORMATION**

- It is recommended that you keep the action open (with the finger lever extended) when your rifle is laying on a bench or table at a shooting range or other facility, and at all other times except when you are in the field and shooting is imminent.

# WINCHESTER®

REPEATING ARMS

**FIGURE 10**

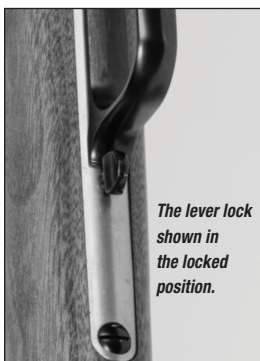

*The lever lock shown in the locked position.*

**FIGURE 11**

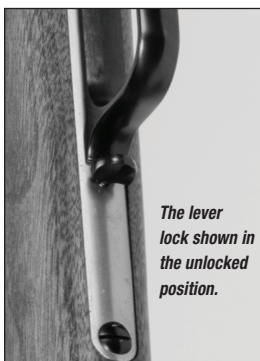

*The lever lock shown in the unlocked position.*

## AMMUNITION

### **⚠ WARNING**

**DISCHARGING FIREARMS IN POORLY VENTILATED AREAS, CLEANING FIREARMS OR HANDLING AMMUNITION MAY RESULT IN EXPOSURE TO LEAD AND OTHER SUBSTANCES KNOWN TO CAUSE BIRTH DEFECTS, REPRODUCTIVE HARM AND OTHER SERIOUS PHYSICAL INJURY. HAVE ADEQUATE VENTILATION AT ALL TIMES. WASH HANDS THOROUGHLY AFTER EXPOSURE.**

**DO NOT USE AMMUNITION OTHER THAN WHAT IS INSCRIBED ON THE BARREL. EXAMINE EVERY CARTRIDGE YOU PUT IN YOUR FIREARM.**

**USE ONLY AMMUNITION SUITABLE FOR USE IN A CENTERFIRE RIFLE WITH A TUBULAR MAGAZINE. USE ONLY FLAT NOSE, HOLLOW POINT, ROUND NOSE FLAT POINT OR SIMILAR BULLETS. NEVER USE POINTED OR CONICAL POINT BULLETS IN A CENTERFIRE RIFLE WITH A TUBULAR MAGAZINE. FAILURE TO FOLLOW THESE INSTRUCTIONS COULD RESULT IN INJURY TO YOURSELF OR OTHERS, AND CAUSE DAMAGE TO YOUR FIREARM.**

The Model 1866 is designed to shoot modern factory cartridges only. The caliber of your new Model 1866 is inscribed on the barrel, just in front of the receiver.

Make sure you use only the exact ammunition/caliber as listed on the barrel.

The barrel and action of this rifle have been made with substantial safety margins over the pressures developed by established American loads. However, we assume no responsibility for incidents which occur through the use of cartridges of nonstandard dimension or those developing pressures in excess of SAAMI (Sporting Arms and Ammunition Manufacturers' Institute) established standards.

### LOADING

#### **▲WARNING**

**WHEN LOADING YOUR RIFLE ALWAYS KEEP THE MUZZLE POINTED IN A SAFE DIRECTION, ALWAYS PLACE THE HAMMER IN THE HALF-COCK POSITION. KEEP YOUR FINGERS AWAY FROM THE TRIGGER. FAILURE TO FOLLOW THESE WARNINGS COULD RESULT IN SERIOUS INJURY OR DEATH.**

**DO NOT CARRY YOUR RIFLE WITH A CARTRIDGE IN THE CHAMBER TO AVOID ACCIDENTAL DISCHARGE. WHEN FIRING IS NO LONGER IMMINENT, UNLOAD THE CHAMBER AND MAKE SURE THE HAMMER IS IN THE HALF-COCK POSITION. FAILURE TO FOLLOW THESE WARNINGS COULD RESULT IN SERIOUS INJURY OR DEATH.**

#### LOADING THE MAGAZINE

The magazine is loaded through a port on the right side of the receiver.

1. With the action closed and the hammer in the half-cock position, press the loading port cover inward with the bullet tip of the first cartridge until all but the rim has entered the loading port (Figure 12, page 22).
2. Insert the next cartridge in the same manner, using it to push the preceding cartridge into the magazine.

**FIGURE 12**

*Push the cartridge into the loading port until it is mostly inside the loading port, then insert another cartridge and use it to push the preceding cartridge into the magazine.*

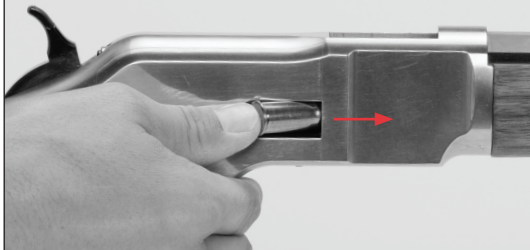

**FIGURE 13**

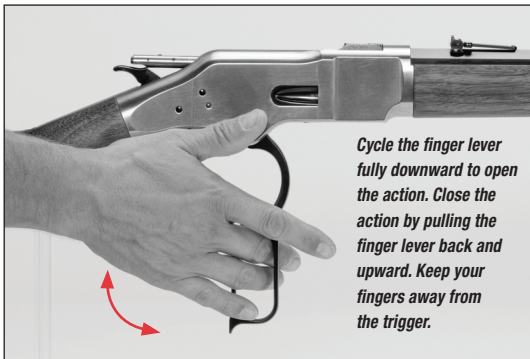

*Cycle the finger lever fully downward to open the action. Close the action by pulling the finger lever back and upward. Keep your fingers away from the trigger.*

3. Repeat this procedure with each cartridge, pushing the last cartridge past the end of the loading port cover and allowing the loading port cover to snap closed.

### **LOADING THE CHAMBER FROM THE MAGAZINE**

1. Load the magazine as explained previously.
2. Cycle the action by pulling the finger lever downward and fully forward then pulling the finger lever back and upward (Figure 13, page 22). This transfers a cartridge from the magazine into the chamber. Keep your fingers away from the trigger.



**FIGURE 14**

*When firing is imminent pull the hammer back to the full-cock position.*



**▲WARNING**

**THE RIFLE IS NOW READY TO FIRE BY HOLDING THE LEVER TIGHT TO THE FRAME AND PULLING THE TRIGGER.**

3. If shooting is not imminent, immediately lower the hammer to the half-cock position. You may now load a single cartridge into the magazine to refill it to maximum capacity.

## FIRING

**▲WARNING**

**NEVER CHAMBER A CARTRIDGE OR COCK THE HAMMER UNLESS SHOOTING IS IMMINENT. ALWAYS KEEP THE MUZZLE POINTED IN A SAFE DIRECTION. FAILURE TO FOLLOW THESE WARNINGS COULD RESULT IN SERIOUS INJURY OR DEATH.**

1. Load the chamber as explained previously.
2. Firmly position your thumb on the hammer and draw the hammer back to the full-cock position (Figure 14, page 23).

**▲WARNING**

**THE RIFLE IS NOW READY TO FIRE BY HOLDING THE LEVER TIGHT TO THE FRAME AND PULLING THE TRIGGER.**

# WINCHESTER®

REPEATING ARMS

3. Take aim, and when on target, squeeze the trigger. After firing, release the trigger to the fully forward position.
4. Swing the finger lever fully down, extracting and ejecting the fired cartridge case from the chamber.

## ▲WARNING

**ALWAYS KEEP YOUR RIFLE SHOULDERED WHEN EJECTING AN EMPTY CARTRIDGE CASE. EJECTION IS UP AND SLIGHTLY TO THE RIGHT. IF YOU EJECT A CARTRIDGE CASE WITH THE RIFLE LOWERED AND THE ACTION DIRECTLY IN FRONT OF YOUR FACE, IT IS POSSIBLE THAT THE EJECTED CARTRIDGE CASE COULD STRIKE YOU IN THE FACE, OR STRIKE A BYSTANDER. FAILURE TO FOLLOW THIS WARNING COULD RESULT IN SERIOUS INJURY.**

When an empty cartridge case is correctly ejected it will fall to the ground in an area behind and to the right of the shooter.

5. Close the action by returning the finger lever upward. The closing of the action will transfer a new cartridge from the magazine to the chamber, leaving the hammer in the full-cock, ready-to-fire position.

To continue shooting, repeat steps 3-4. If you are finished shooting go immediately to step 6.

You may continue shooting until the magazine is empty, at which time you will need to either reload the magazine with cartridges (if shooting is imminent), or completely unload your rifle (if shooting is no longer imminent).

6. When firing is completed or when shooting is no longer imminent, immediately place the hammer in the half-cock position. Under no circumstances should you move on or continue to hunt with the hammer in the dropped position.

## ▲WARNING

**AFTER FIRING, OR WHEN SHOOTING IS NO LONGER IMMINENT, IMMEDIATELY MOVE THE HAMMER TO**

**THE HALF-COCK POSITION. FAILURE TO FOLLOW THESE WARNINGS COULD RESULT IN SERIOUS INJURY OR DEATH.**

## UNLOADING

### **▲WARNING**

**WHEN UNLOADING YOUR RIFLE ALWAYS KEEP THE MUZZLE POINTED IN A SAFE DIRECTION AND YOUR FINGERS AWAY FROM THE TRIGGER. FAILURE TO FOLLOW THESE WARNINGS COULD RESULT IN SERIOUS INJURY OR DEATH.**

**ALWAYS INSPECT THE CHAMBER, BARREL, FEED MECHANISM AND MAGAZINE CAREFULLY AFTER UNLOADING TO BE SURE ALL LIVE CARTRIDGES ARE CLEARED FROM THE FIREARM. FAILURE TO FOLLOW THIS WARNING COULD RESULT IN SERIOUS INJURY OR DEATH.**

Completely unloading your rifle for storage and other appropriate situations is essential to safe gun handling.

1. Swing the finger lever completely downward. This will extract any cartridge from the chamber and eject it. Capture the cartridge and return the finger lever fully upward.
2. Continue to operate the finger lever in the same manner transferring all the remaining cartridges from the magazine to the chamber and then ejecting them out.
3. When cartridges no longer eject when you cycle the action, further assure that no cartridges remain by opening the action and visually checking the chamber, lifter and magazine follower to be certain that the rifle is completely unloaded (Figure 15, page 26). After the last live cartridge is moved out of the magazine and ejected, immediately lower the hammer to the half-cock position as explained previously.

**FIGURE 15**

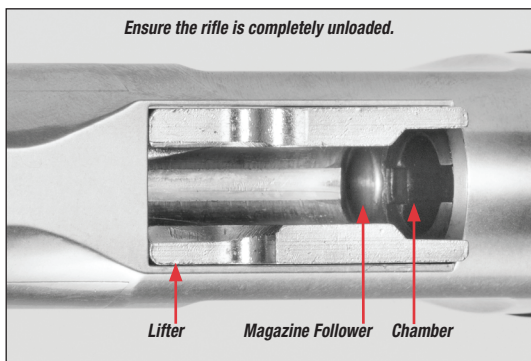

## SIGHT ADJUSTMENT

### **▲WARNING**

**BEFORE ADJUSTING THE SIGHTS, OPEN THE ACTION AND MAKE CERTAIN YOUR RIFLE IS COMPLETELY UNLOADED. KEEP THE MUZZLE POINTED IN A SAFE DIRECTION. FAILURE TO FOLLOW THESE WARNINGS COULD RESULT IN SERIOUS INJURY OR DEATH.**

The Model 1866 is fitted with adjustable open sights. The proper procedure is to shoot a group with the sights set as they come from the factory, and then make incremental adjustments to position the group on your target. The rear sight in the folded position is set for approximately 50 yards.

### **UP OR DOWN ELEVATION ADJUSTMENTS**

Adjusting elevation on your Model 1866 sight requires you to lift up the ladder on your rifle's rear sight with your fingers and slide the elevator up or down (Figure 16, page 27).

To raise point of impact, use your fingers to lift up on the blade and slide the elevator upward. Adjusting the sight to make your gun shoot lower is just the opposite, move the elevator downward.

**FIGURE 16**

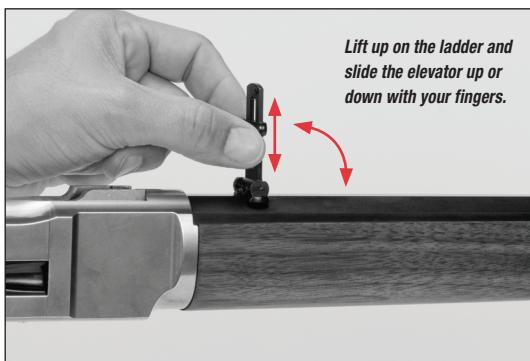

- Move the rear sight blade elevator upward to shoot higher on the target.
- Move the rear sight blade elevator downward to shoot lower on the target.

### **RIGHT OR LEFT WINDAGE ADJUSTMENTS**

On most Model 1866 sights, the rear sight base is dovetailed in the rear of the barrel. To adjust for windage, gently move the rear sight base to the right or left by tapping the sight base at the dovetail using a wood or fiber dowel or hammer that will not mar the sight (Figure 17, page 28).

- Move the rear sight base to the right to shoot farther to the right on the target.
- Move the rear sight base to the left to shoot farther to the left on the target.

Care should be taken not to mar the finish or bend sight components when adjustments are made.

All sight adjustments are a matter of trial and error. Remember, it is usually necessary to adjust your sights when you change type or even brand of ammunition.

**FIGURE 17**

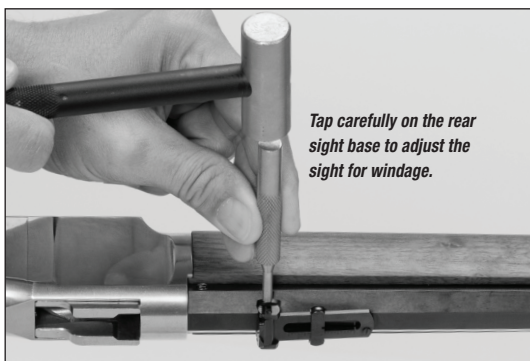

*Tap carefully on the rear sight base to adjust the sight for windage.*

## CLEANING AND MAINTENANCE SUGGESTIONS

### **▲WARNING**

**BEFORE PERFORMING CLEANING PROCEDURES, OPEN THE ACTION AND MAKE CERTAIN YOUR RIFLE IS COMPLETELY UNLOADED. KEEP THE MUZZLE POINTED IN A SAFE DIRECTION. FAILURE TO FOLLOW THESE WARNINGS COULD RESULT IN SERIOUS INJURY OR DEATH.**

### **▲WARNING**

**WEAR EYE PROTECTION WHEN DISASSEMBLING AND CLEANING YOUR RIFLE TO PREVENT SPRINGS, SPRING-LOADED PARTS, SOLVENTS OR OTHER AGENTS FROM CONTACTING YOUR EYES, RESULTING IN INJURY.**

### **▲WARNING**

**KEEP ALL AMMUNITION AWAY FROM THE CLEANING AREA. NEVER TEST THE MECHANICAL FUNCTION OF YOUR RIFLE WITH LIVE AMMUNITION. FAILURE TO FOLLOW THESE WARNINGS COULD RESULT IN SERIOUS INJURY OR DEATH.**

### CLEANING PROCEDURES

Your Model 1866 will function better and more reliably over a longer period of time if it is properly maintained and kept clean. Clean your firearm after each day of shooting and more often if it becomes excessively dirty. A minimum cleaning includes wiping down the action and oiling key parts. Regular maintenance will also include cleaning the barrel.

If you encounter a function problem be sure to give your firearm a thorough cleaning to see if it solves the problem before seeking the services of a Winchester Repeating Arms Authorized Service Center or our Service Facility in Arnold, Missouri, or a qualified gunsmith.

1. Open the action by completely lowering the lever.
2. Use a cleaning rod with a tip and patch large enough for a snug fit in the bore. Insert the rod and patch into the barrel at the muzzle end and run it back and forth several times. Care should be exercised to ensure that neither the cleaning rod nor the handle strikes the crown of the muzzle, as damage to this area can adversely affect the accuracy of the rifle. A muzzle guard can be purchased separately from your local firearms dealer to help protect the muzzle crown while cleaning the barrel of your rifle.
3. Inspect the chamber and bore for brass, copper and powder fouling. A normal amount of powder residue can be expected and is not serious. It can usually be removed by repeating step 2, using a patch saturated with solvent. If, or when, fouling should become heavy, it can be removed with a brass bore brush. Dip or spray the brush with solvent and scrub the chamber and bore until the fouling is removed. To prevent brass bristles from breaking off, the brush should be pushed completely through the bore before being withdrawn. Your rifle will operate more smoothly and reliably with a clean bore and chamber.

4. To maintain the utmost accuracy of your rifle, clean the bore with a copper or lead solvent. Swab the bore of your rifle with solvent using the product manufacturer's recommended procedure.
5. After fouling has been removed, wipe the bore dry. Then pass a lightly oiled patch through the barrel for preservation. A fine, light gun oil is recommended. The barrel and action should be inspected thoroughly to be certain no cleaning patches have been inadvertently left in them.
6. The interior of the receiver and the bolt should periodically be wiped with a clean rag. Any dried oil in these areas or on the magazine follower should be removed. Follow this cleaning by applying a very light film of oil on the affected parts.
7. Lightly oil your firearm at the points described under "Initial Cleaning and Oiling" on pages 14-16. Ordinary good judgment will, of course, indicate that the metal of the gun should receive a light film of oil any time the rifle has been exposed to weather or handling. Remember, the polished, finely fitted surfaces of the receiver and action mechanisms must always have a thin film of oil.

## **NOTICE**

**DO NOT POUR LARGE QUANTITIES OF OIL INTO THE RECEIVER OR OTHER PARTS. IT CAN DRAIN DOWN TO THE WOOD AND SOFTEN IT, CAUSING PERMANENT DAMAGE AND LOOSENING OF THE STOCK.**

8. Wipe all exposed metal surfaces of the receiver, forearm and barrel with a clean rag. Finger marks should be removed because they provide a place where moisture can accumulate. Any dried oil in the receiver area should also be removed.
9. Inspect the barrel and chamber. Make certain that no patches have been inadvertently left in them. Remove any that remain.



10. The wood surfaces of your rifle can also be wiped lightly with fine oil, or you can apply a quality wood or furniture polish to the stock and forearm. Using one of these methods (not both), will enhance the beauty and durability of your rifle.

### ADDITIONAL SUGGESTIONS

- When transporting your rifle, store it in a quality protective case to prevent scratches and dents. Store your rifle in a cool, dry place to prevent corrosion. Store your rifle and ammunition separately, away from children.
- After extended periods of heavy use, your gun should be taken to a qualified gunsmith to have the action disassembled for professional cleaning and lubrication.

### **NOTICE**

**NEVER ATTEMPT TO TAKE YOUR FIREARM APART FURTHER THAN EXPLAINED IN THIS OWNER'S MANUAL. YOUR FIREARM IS A SPECIALIZED, FINELY FITTED MECHANISM. YOU MAY PERMANENTLY DAMAGE IT BY ATTEMPTING TO DISASSEMBLE THE INNER MECHANISM. IF FURTHER DISASSEMBLY FOR SERVICE OR CLEANING IS REQUIRED, TAKE YOUR FIREARM TO A QUALIFIED GUNSMITH, OR CONTACT OUR ARNOLD, MISSOURI SERVICE FACILITY AS EXPLAINED UNDER "PARTS, SERVICE, REPAIR AND QUESTIONS" ON PAGE 32.**

## PARTS, SERVICE, REPAIR AND QUESTIONS

If your Winchester rifle or shotgun should ever need service or repair, it is often best to contact a Winchester Repeating Arms Authorized Repair Center. To locate an Authorized Repair Center visit [winchesterguns.com](http://winchesterguns.com) or contact our customer service department. In some cases it is appropriate to use the Winchester Repeating Arms Service Facility in Arnold, Missouri. If you have any questions contact our customer service department and we can help you determine the best place to service your firearm.

Parts listings, Authorized Repair Center lists, service procedures, service/repair form and general product information are also found on the web at [winchesterguns.com](http://winchesterguns.com).

When returning your firearm for servicing, you must do the following:

1. Be sure it is completely unloaded.
2. Remove the scope or other optics.
3. Package it securely in a cardboard container.
4. When sending your firearm, enclose the service/repair form available at [winchesterguns.com](http://winchesterguns.com) or a letter that clearly describes the trouble experienced, the ammunition used and the repairs desired. Also include your name, e-mail address (if possible) and a daytime phone number where you can be reached.
5. If convenient, send a copy of the service/repair form or letter to us separately.
6. Never return ammunition with your firearm. It is against postal and most commerce regulations.

# WINCHESTER®

REPEATING ARMS

## PARTS, SERVICE, REPAIR STATUS AND TECHNICAL QUESTIONS

Winchester Repeating Arms Parts and Service  
3005 Arnold Tenbrook Road  
Arnold, MO 63010-9406  
(800) 322-4626

## GENERAL PRODUCT AND HISTORICAL QUESTIONS

Winchester Repeating Arms Customer Service  
275 Winchester Avenue  
Morgan, UT 84050-9333  
(800) 945-5237

### **▲WARNING**

**PARTS ARE MADE FOR WINCHESTER BRAND  
FIREARMS MANUFACTURED BY OR FOR  
WINCHESTER REPEATING ARMS, AND SHOULD NOT  
BE USED IN OTHER FIREARMS, EVEN THOUGH  
MODELS MAY BE SIMILAR. IMPROPERLY FITTED  
PARTS MAY BE DANGEROUS.**

## WEBSITE INFORMATION

---

An information resource for Winchester Repeating Arms can be found online.

- List of Authorized Repair Centers.
- Customer Service information.
- Firearm Service/Repair Form.
- Answers to many technical and historical questions.
- Links to helpful sites.

Go to [winchesterguns.com](http://winchesterguns.com)

**WINCHESTER<sup>®</sup>**

REPEATING ARMS

NOTES

**WINCHESTER®**

REPEATING ARMS

NOTES

---

**WINCHESTER®**

REPEATING ARMS

NOTES





Winchester Repeating Arms  
275 Winchester Avenue  
Morgan, UT 84050-9333  
(800) 945-5237  
[winchesterguns.com](http://winchesterguns.com)

Winchester is a registered trademark of Olin Corporation.

AO1810/18453