

MODEL 101®

Winchester® Model 101™ Over and Under Shotgun Owner's Manual

Important instructions for

Winchester® Model 101™ Over and Under Shotgun

Winchester Repeating Arms
Customer Service Department (United States)
275 Winchester Avenue
Morgan, Utah 84050-9333
Phone: (800) 945-5237

If you have any questions or comments regarding
your new firearm, please feel free to write or call us.
Use the space below to record information about your
new firearm.

Model _____

Serial Number _____

Purchased From _____

Date of Purchase _____



Winchester is a registered trademark of Olin Corporation.

Specifications within this owner's manual are correct at the time of printing and
subject to change without notice.

Contents	Page
State Warning	1
WARNING: You Are Responsible for Firearms Safety. . .	1
General Description and Operation	6
Nomenclature	7
Serial Number	10
Initial Cleaning and Lubrication.	10
Operation of the "Safety"/Selector	11
Barrel Selector	12
Top Lever	13
Assembly	14
Disassembly	16
Ammunition	17
Loading	18
Firing	20
Unloading	21
Interchangeable Choke Tube System	22
Changing Length of Pull (Special Models).	24
Adjustable Stock (Special Models).	25
Barrel Porting (Special Models)	28
Maintenance of Oil Finish Stocks.	28
Models with Special Finishes.	28
Cleaning and Maintenance Suggestions.	28
Parts, Service, Repair and Questions	32
Website Information	33

STATE WARNING

According to state law, California requires that firearm manufacturers, distributors and retailers include conspicuous, specific warnings with firearms sold in that state.

 WARNING	 ADVERTENCIA
<p>Firearms must be handled responsibly and securely stored to prevent access by children and other unauthorized users.</p> <p>California has strict laws pertaining to firearms, and you may be fined or imprisoned if you fail to comply with them. Visit the Web site of the California Attorney General at https://oag.ca.gov/firearms for information on firearm laws applicable to you and how you can comply.</p> <p>Prevent child access by always keeping guns locked away and unloaded when not in use. If you keep a loaded firearm where a child obtains and improperly uses it, you may be fined or sent to prison.</p>	<p>Las armas de fuego deben de ser manipuladas responsablemente y almacenadas en sitios seguros para prevenir el acceso a ellas por parte de niños y personas sin autorización.</p> <p>California cuenta con leyes estrictas sobre las armas de fuego, y puede ser multado y encarcelado si no las obedece. Visite la página web de California Attorney General, https://oag.ca.gov/firearms para más información sobre cómo cumplir con las leyes de armas de fuego.</p> <p>Prevenza el acceso de los niños a las armas de fuego manteniéndolas siempre en un lugar seguro, bajo llave y descargadas cuando no estén en uso. Si usted deja un arma cargada al alcance de un niño, y éste la utiliza indebidamente, usted podría ser multado e incluso enviado a la cárcel.</p>

WARNING: YOU ARE RESPONSIBLE FOR FIREARMS SAFETY

WARNING

FAILURE TO FOLLOW ANY OF THE FOLLOWING WARNINGS COULD RESULT IN SERIOUS INJURY OR DEATH.

As a firearm owner, you accept a set of demanding responsibilities. How seriously you take these responsibilities can be the difference between life and death.

There is no excuse for careless or abusive handling of any firearm. At all times handle this firearm and all other firearms with intense respect for their power and potential danger.

Please read and understand all of the cautions, warnings, notices, proper handling procedures and instructions outlined in this owner's manual before using your new firearm.

- 1 ALWAYS KEEP THE MUZZLES OF YOUR FIREARM POINTED IN A SAFE DIRECTION EVEN THOUGH YOU ARE CERTAIN IT IS UNLOADED.**
Never point any firearm at anything you do not intend to shoot. Be extremely alert and aware of all persons and property within the range of your ammunition.
- 2 NEVER RELY TOTALLY ON YOUR FIREARM'S MECHANICAL "SAFETY" DEVICE. LIKE ANY MECHANICAL DEVICE, A "SAFETY" CAN SOMETIMES FAIL; IT CAN BE JARRED OR INADVERTENTLY MANIPULATED INTO AN UNSAFE CONDITION.**
The word "safety" describes a firearm's trigger block mechanism, sear block mechanism, hammer block mechanism or firing pin block mechanism. Mechanical "safeties" are designed to place your

firearm in a safer status, and no guarantee can be made that the firearm will not fire even if the “safety” is in the on safe position. Mechanical “safeties” merely aid safe gun handling and are no excuse for pointing your firearm’s muzzle in an unsafe direction. See “Operation of the “Safety”/Selector” on pages 11-12 for instructions on the operation of this firearm’s “safety.”

Remember, safe gun handling does not stop with your firearm’s mechanical “safety” devices, it starts there. Always treat this firearm with the respect due a loaded, ready-to-fire firearm.

Some firearms do not have a mechanical “safety.” Many target firearms, lever-action firearms and pistols do not have manual “safety” mechanisms. Therefore it is critical to read and understand the owner’s manual for every firearm which explains the safe operation of the firearm.

While it is a good idea to test your firearm’s mechanical “safety” periodically for proper function, never test the “safety” while your firearm is loaded or pointed in an unsafe direction.

3 WHENEVER YOU HANDLE ANY FIREARM, OR HAND IT TO SOMEONE, ALWAYS OPEN THE ACTION IMMEDIATELY AND VISUALLY CHECK THE FIREARM’S CHAMBER TO MAKE CERTAIN THAT THE FIREARM IS COMPLETELY UNLOADED.

Make certain the firearm does not inadvertently contain any ammunition. Remember, merely removing the magazine does not mean the chamber is unloaded. Always keep the chamber empty and the “safety” in the on safe position unless shooting is imminent.

4 ALWAYS WEAR EAR AND EYE PROTECTION WHEN SHOOTING.

Unprotected, repeated exposure to gunfire can cause hearing damage. Wear hearing protection (shooting earplugs or muffs) to guard against such damage.

Wear shooting glasses to protect your eyes from flying particles. Allow proper distance (eye relief) between a scope and your eye when firing a scoped pistol, rifle or shotgun. Do not use unorthodox shooting methods that could cause the rearward travel of the slide or bolt of a firearm to contact your eyes, face or hands. Always keep a safe distance between the muzzle of your firearm and any persons nearby, as muzzle blast, debris and ejecting shells could inflict serious injury.

Always wear eye protection when disassembling and cleaning any firearm to prevent the possibility of springs, spring-tensioned parts, solvents or other agents from contacting your eyes.

5 KEEP ALL FIREARMS UNLOADED DURING TRANSPORT, EVEN WHEN STORED IN A HOLSTER, GUN CASE, SCABBARD OR OTHER CONTAINER.

6 DROPPING OR JARRING A LOADED FIREARM CAN CAUSE ACCIDENTAL DISCHARGE.

This can occur even with the “safety” in the on safe position. Be extremely careful while hunting or during any shooting activity to avoid dropping any firearm.

7 HUNTING FROM ELEVATED SURFACES SUCH AS TREESTANDS IS DANGEROUS.

Doing so may increase the risk of mishandling a firearm. The following rules should always be observed by you and those you hunt with. Always make certain that the stand being used is safe and stable. Always make certain that your firearm is unloaded when it is being taken up and down from the stand. Always make certain that your firearm is not dropped from the stand, or dropped while it is being taken up or down from the stand. Remember, a loaded firearm may discharge when dropped, even with the “safety” in the on safe position.

8 STORE YOUR FIREARM AND AMMUNITION SEPARATELY, WELL BEYOND THE REACH OF CHILDREN.

Take prudent safeguards to ensure your firearm does not become available to untrained, inexperienced or unwelcome hands. Store all firearms in secure, locked cases or a gun safe. Keep your firearm unloaded when not in use.

9 BEWARE OF BARREL OBSTRUCTIONS.

Mud, snow and an infinite variety of other objects may inadvertently lodge in a barrel bore. It only takes a small obstruction to cause dangerously increased pressures that can damage your firearm and cause serious injury to yourself and others.

BEFORE CHECKING FOR A BARREL OBSTRUCTION, BE CERTAIN YOUR FIREARM IS COMPLETELY UNLOADED, THERE IS NOT A LIVE SHELL IN THE CHAMBER AND THE “SAFETY” IS IN THE ON SAFE POSITION.

After ensuring that the firearm is completely unloaded, open the breech or action and look through the barrel to be sure it is clear of obstructions. If an obstruction is seen, no matter how small it may be, clean the bore with a cleaning rod and patch as described on pages 28-30 of this owner’s manual.

10 BE ALERT TO THE SIGNS OF AMMUNITION MALFUNCTION. IF YOU DETECT AN OFF SOUND OR LIGHT RECOIL WHEN A SHELL IS FIRED, DO NOT LOAD ANOTHER SHELL INTO THE CHAMBER.

If your firearm fails to fire, keep the muzzles pointed in a safe direction for a minimum of 30 seconds. Rotate the ejection area of the firearm away from you, carefully open the action and remove the shell from the chamber. If the primer is indented, the defective shell should be disposed of in a way that cannot cause harm. If the primer is not indented, your firearm

should be examined by a qualified gunsmith and the cause of the malfunction corrected before further use. Glance down the barrel to make sure that no obstructions remain in the barrel. Completely clear the barrel before loading and firing again. Failure to follow these instructions can cause extensive damage to your firearm and possible serious injury to yourself and others.

11 NEVER INSERT A SHELL OF THE INCORRECT GAUGE INTO ANY FIREARM.

The gauge of your firearm is marked on the barrel. Store all shells of different gauges in completely separate and well-marked containers. Never store shells of mixed gauges in a common container or in your pockets. See pages 17-18 for more information on the correct ammunition for your firearm.

12 EXAMINE EVERY SHELL YOU PUT IN YOUR FIREARM.

We assume no responsibility for the use of unsafe or improper firearm and ammunition combinations or damage or injury caused by damaged ammunition. It is your responsibility to read and heed all warnings in this owner's manual and on ammunition boxes. See pages 17-18 for more information on the correct ammunition for your firearm.

13 USE ONLY SAAMI APPROVED AMMUNITION.

The barrels and action of this firearm have been made with safety margins over the pressures established by the Sporting Arms and Ammunition Manufacturers'

Institute (SAAMI) for Service Cartridges. However, we assume no responsibility for incidents which occur through the use of cartridges of nonstandard dimension or those developing pressures in excess of SAAMI established standards.

14 DISCHARGING FIREARMS IN POORLY VENTILATED AREAS, CLEANING FIREARMS OR HANDLING AMMUNITION MAY RESULT IN EXPOSURE TO LEAD AND OTHER SUBSTANCES KNOWN TO CAUSE BIRTH DEFECTS, REPRODUCTIVE HARM AND OTHER SERIOUS PHYSICAL INJURY. HAVE ADEQUATE VENTILATION AT ALL TIMES. WASH HANDS THOROUGHLY AFTER EXPOSURE.

15 DO NOT SNAP THE FIRING PIN ON AN EMPTY CHAMBER; THE CHAMBER MAY NOT BE EMPTY!

Treat every firearm with the respect due a loaded firearm, even though you are certain the firearm is unloaded.

16 KEEP YOUR FINGERS AWAY FROM THE TRIGGER WHILE LOADING AND UNLOADING UNTIL SHOOTING IS IMMINENT.

17 BE SURE OF YOUR TARGET AND BACKSTOP, PARTICULARLY DURING LOW LIGHT PERIODS.

Know the range of your ammunition. Never shoot at water or hard objects.

18 ALWAYS UNLOAD YOUR FIREARM'S CHAMBER BEFORE CROSSING A FENCE, CLIMBING A TREE, JUMPING A DITCH OR NEGOTIATING OTHER OBSTACLES.

Never place your firearm on or against a fence, tree, car or other similar object.

19 BE DEFENSIVE AND ON GUARD AGAINST UNSAFE GUN HANDLING AROUND YOU AND OTHERS.

Don't be timid when it comes to firearm safety. If you observe other shooters violating any of these safety precautions, politely suggest safer handling practices.

20 BE CERTAIN YOUR FIREARM IS UNLOADED BEFORE CLEANING.

Special and extreme care should be taken to be sure your firearm is unloaded before disassembly, cleaning and reassembly.

Keep ammunition away from the cleaning location. Never test the mechanical function of any firearm with live ammunition.

21 TEACH AND SUPERVISE FIREARMS SAFETY TO ALL MEMBERS OF YOUR FAMILY, ESPECIALLY TO CHILDREN AND NON-SHOOTERS.

Closely supervise newcomers to the shooting sports. Encourage enrollment in hunting and shooting safety courses.

22 NEVER DRINK ALCOHOLIC BEVERAGES OR TAKE ANY TYPE OF DRUGS BEFORE OR DURING SHOOTING.

Your vision, motor skills and judgment could be dangerously impaired, making your gun handling unsafe to you and to others.

23 READ AND HEED ALL WARNINGS IN THIS OWNER'S MANUAL, ON AMMUNITION BOXES AND WITH ALL ACCESSORIES THAT YOU INSTALL ON YOUR FIREARM.

It is your responsibility to secure the most up-to-date information on the safe handling procedures of your Winchester firearm. We assume no liability for incidents which occur when unsafe or improper firearm accessories or ammunition combinations are used.

24 PRACTICE PERIODIC MAINTENANCE, AVOID UNAUTHORIZED SERVICING.

Your firearm is a mechanical device which will not last forever, and as such, is subject to wear and requires periodic inspection, adjustment and service. Winchester firearms should be serviced by a Winchester Repeating Arms Authorized Repair Center or by our Service Facility in Arnold, Missouri. We assume no responsibility for injuries suffered or caused by unauthorized servicing, alterations or modifications of Winchester firearms.

25 DO NOT, UNDER ANY CIRCUMSTANCES, ALTER THE TRIGGER, “SAFETY” OR OTHER PARTS OF THE FIRING MECHANISM OF THIS OR ANY OTHER FIREARM EXCEPT AS OTHERWISE DESCRIBED IN THIS MANUAL.

We reserve the right to refuse service on firearms that have been altered, added to or substantially changed. Removal of metal from the barrel, or modifications of the firing mechanism and/or operating parts may lead to a refusal of service on such firearms. You will be charged for parts and labor to return the firearm to original specifications prior to servicing your firearm.

With respect to **AFTERMARKET PARTS OR COMPONENTS** (including, for example, aftermarket trigger systems, barrels, muzzle brakes, suppressors, magazines, etc.), **USE AT YOUR OWN RISK**. Winchester firearms are designed and engineered to meet stringent safety standards. Winchester Repeating Arms is not responsible for personal injuries or property damage caused by alterations to a firearm. This includes the incorporation of aftermarket parts or components that may or may not satisfy Sporting Arms and Ammunition Manufacturers’ Institute (SAAMI) standards (for example, an aftermarket trigger system may not satisfy SAAMI minimum trigger pull standards, etc.) or may create other dangerous conditions. These conditions may or may not be apparent to the user (for example, installing an aftermarket barrel may have the effect of altering

critical firearm dimensions, including headspace, and may create an unsafe firing condition, etc.). Aftermarket parts or components that do not satisfy SAAMI standards, or that could create other dangerous conditions, should not be used.

FAILURE TO FOLLOW THIS WARNING COULD RESULT IN SERIOUS INJURY OR DEATH, AS WELL AS CAUSE DAMAGE TO YOUR FIREARM.

BE CAREFUL!

GENERAL DESCRIPTION AND OPERATION

Balance. Pointability. Reliability. Handling. These are qualities you expect from an over and under, and they’re what you’ll get with the Model 101. This shotgun provides a lively feel that allows you to quickly shoulder and move to your target. The low-profile receiver combined with ideal stock dimensions put you on target consistently.

The Model 101 is an over and under shotgun made to fire two successive shots by pulling the trigger twice, once for each shot. Each time the action is opened after firing, the hammers are cocked and empty shells (one or two) are ejected clear of the chamber(s) automatically. Unfired shells are elevated in the chambers. The action is opened with a lever mounted on the top of the receiver just forward of the “safety”/selector. The shotgun breaks down into three pieces for cleaning or storage.

FIGURE 1

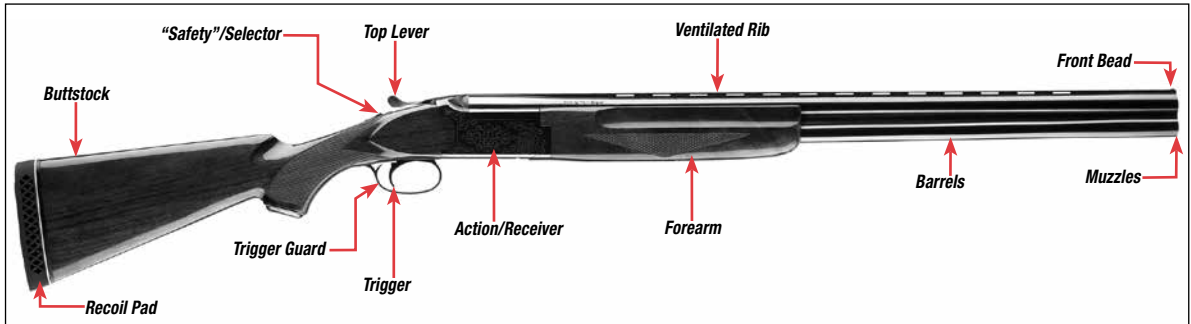

Prior to using live ammunition, familiarize yourself thoroughly with all the operating instructions in this owner's manual. Get accustomed to the feel of your new firearm. Know the forces required to operate the action. Understand how to select the firing order of the barrels. Learn how to pull the trigger correctly, and above all, know the location and operation of the "safety"/selector. Procedures for disassembly and operation of various components are outlined in the following sections. Please read and study them thoroughly.

NOMENCLATURE

In conventional firearm terminology the position and movement of firearm parts are described as they occur with the firearm horizontal and in normal firing position: i.e., the muzzles are forward or in front; the buttstock is

rearward or to the rear; the trigger is downward or underneath; the rib is upward or on top. For general parts nomenclature, refer to Figure 1 (page 7). The shotgun is also shown disassembled to the extent necessary in order

FIGURE 2

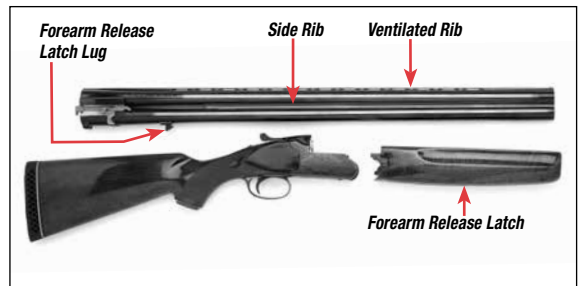

(Continued on page 10)

FIGURE 3

MODEL 101[®]
WINCHESTER

MODEL 101 SHOTGUN FEATURES

The walnut stock features intricate checkering and is sculpted for fast handling and to reduce felt recoil on the cheek.

The top-tang "safety"/selector is easy to operate.

A pair of heavy duty locking pins are made to stay tight under years of heavy use and allow an overall lower receiver profile than found on other over and under shotguns.

The rugged, low-profile receiver design lowers the bore line to reduce perceived recoil.

A Pachmayr[®] Decelerator[®] recoil pad provides maximum comfort.



The lightweight profile barrels point and swing with authority and are back-bored to improve pattern performance.

The barrels and forearm remove for easy cleaning and storage.

Interchangeable Invector-Plus™ choke tubes allow you to easily change choke constrictions to meet the demands of the game or target.

FIGURE 4

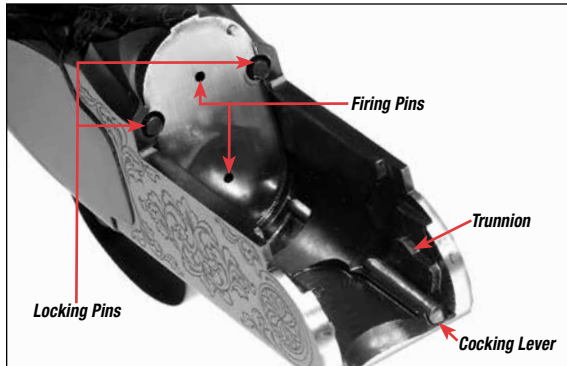
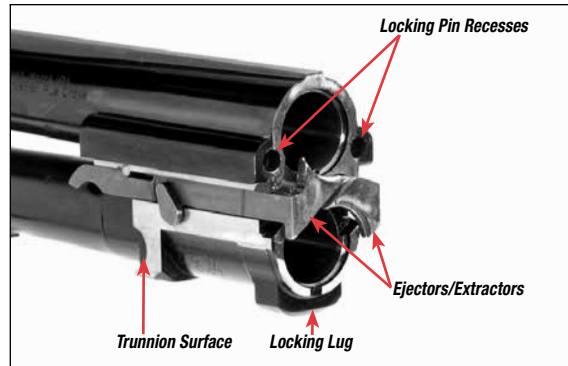

FIGURE 5



to follow instructions contained in this owner's manual in Figure 2 (page 7). Figure 3 (pages 8-9) cover the general features and benefits of the Model 101 design. Details of the action are shown in Figure 4 and Figure 5 (page 10).

Throughout this owner's manual the "action" refers to the mechanism of this shotgun that secures the shells in the chambers.

SERIAL NUMBER

The serial number is located on the top tang of the receiver under the top lever. Record the serial number at the front of this owner's manual for future reference.

NOTICE

DO NOT INTERCHANGE THE RECEIVER, BARRELS OR FOREARM WITH OTHER SHOTGUNS EVEN THOUGH THE PARTS MAY APPEAR SIMILAR.

INITIAL CLEANING AND LUBRICATION

WARNING

WEAR EYE PROTECTION WHEN ASSEMBLING AND DISASSEMBLING YOUR SHOTGUN TO PREVENT SPRINGS, SPRING-LOADED PARTS, SOLVENTS OR OTHER AGENTS FROM CONTACTING YOUR EYES, RESULTING IN INJURY.

Some metal parts of your new firearm have been coated at the factory with a rust preventative compound.

Before assembling and using your shotgun, clean the anti-rust compound from the inside of the barrels, receiver area, locking pin mechanism, extractors/ejectors, trunnion surfaces and the chamber areas. A high quality, lightweight gun oil should be used to remove this compound and to give your new firearm its first lubrication.

Grease is recommended to lubricate the barrel lug and trunnion surfaces and forearm bracket surfaces on both sides of the receiver to prevent possible galling. Lubricate the surfaces shown in Figure 6 and Figure 7 (page 11). Avoid applying too much lubricant, as only a light film is necessary. Excessive lubricant should be wiped off.

Clean the barrels using a cleaning rod and patch as explained under “Cleaning and Maintenance Suggestions” on pages 28-30.

If your firearm is to be stored for an extended period of time, it is permissible to leave the rust preventative compound in place and keep your firearm in its box for maximum protection during long-term storage.

NOTICE

THE FINELY FITTED SURFACES OF THE RECEIVER AND FOREARM MECHANISMS (TRUNNION SURFACES, BARREL LUG AND FOREARM BRACKET) MUST ALWAYS BE COATED WITH A FILM OF HIGH QUALITY GREASE.

FIGURE 6

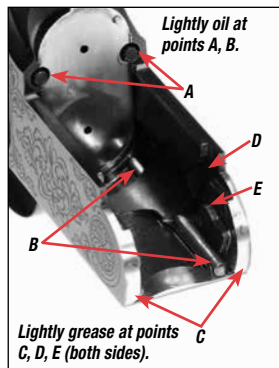
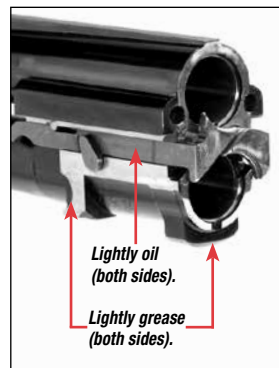

FIGURE 7



OPERATION OF THE “SAFETY”/SELECTOR

⚠ WARNING

ALWAYS KEEP THE “SAFETY” IN THE ON SAFE POSITION UNLESS SHOOTING IS IMMINENT. VISUALLY CHECK YOUR “SAFETY” TO BE CERTAIN IT IS IN THE ON SAFE POSITION BEFORE LOADING. ALWAYS KEEP THE MUZZLES POINTED IN A SAFE DIRECTION. FAILURE TO FOLLOW THESE WARNINGS COULD RESULT IN SERIOUS INJURY OR DEATH.

Your shotgun features a top-tang mounted “safety”/selector located just rearward of the top lever. It is operated with the thumb of your rearward hand when holding the firearm in the shooting position.

FIGURE 8



FIGURE 9

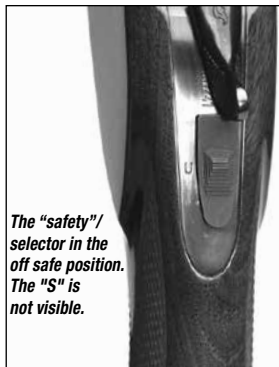

To place the firearm on safe, pull the "safety"/selector fully to the rear with your thumb. When the "safety"/selector is fully rearward, an "S" is exposed at the front of the "safety"/selector. This shows you visually that the "safety" is in the on safe position (Figure 8, page 12). With the "safety" in the on safe position the trigger is disconnected and the shotgun cannot be fired.

To place the firearm off safe, push the "safety"/selector fully forward with your thumb (Figure 9, page 12). When the "safety"/selector is fully forward, the "safety"/selector covers the "S." In the off safe position, if your shotgun is loaded with shell(s) in the chamber(s), the chambered shell(s) can be fired by simply pulling the trigger.

At all times keep the "safety"/selector in the on safe

position and the barrels pointed in a safe direction. It is a good idea never to load your shotgun until you are in the field, at the location you intend to begin hunting or you are at your station on a range and it is your turn to shoot. For extra safety on a range, and as a courtesy to others, fully unload the chambers and keep the action open at all times other than when it is your turn to shoot.

BARREL SELECTOR

The "safety"/selector on the top tang of your shotgun also serves as the barrel selector. The barrel selector allows you to choose which barrel will fire with the first pull of the trigger. The other barrel will then fire with the second pull of the trigger. The "safety"/selector must be in the on safe, rearward position to operate the barrel selector.

The "safety"/selector can be moved to the right or left covering and uncovering the letters "U" and "O." On the left side of the "safety"/selector the letter "U" stands for "under." On the right side the letter "O" stands for "over."

- If the letter "U" is exposed, the under (lower) barrel will fire first (Figure 10, page 13).
- If the letter "O" is exposed, the over (top) barrel will fire first (Figure 11, page 13).

Choke tubes with different constrictions are often installed in each barrel to make one barrel's choke preferable for a certain shot. There is also slightly less muzzle jump when the lower barrel is fired first, making it easier to pick up your target for a follow-up shot. The

barrel selector allows you to choose the best choke and barrel firing order combination for rapidly changing hunting conditions or to adapt to the layout of a sporting clays station.

Always make sure that the “safety”/selector is completely to one side or the other. If the “safety”/selector is inadvertently positioned directly between “O” and “U” it may be more difficult to move to the off safe position.

TOP LEVER

The top lever operates the locking pins, which are fitted to the barrel lugs. Moving the top lever to the right unlocks the action and allows the shotgun to be loaded and unloaded.

It is not necessary that the top lever return to a completely centered position, nor should it hang over the right side or edge of the receiver tang. Upon closing the action, let the top lever snap into position to allow the top lever spring to return the top lever mechanism to the locked position. Do not retard its action with your thumb.

Many shooters lightly push the top lever to the left after closing the breech. This operation is a quick method of ensuring that foreign matter has not interfered with the complete closure of the breech.

FIGURE 10



FIGURE 11



Always keep the polished breech surfaces clean and lightly lubricated. The breech is so carefully hand-fitted that accumulated debris, sand, etc. may prevent complete closing. If this should occur the action will not close. Open the action and unload it. Carefully examine the action surfaces and remove any foreign matter.

Additionally, provision is made for the gradual wear of locking surfaces to keep the action tight. It is common, because of the tight tolerances and craftsmanship of your shotgun, for the top lever to be just slightly right of center, even when the action is fully closed (Figure 12, page 14). This is a sign of a finely crafted firearm and the result of tight tolerances which ensure excellent receiver-to-barrel fit for many years to come.

FIGURE 12

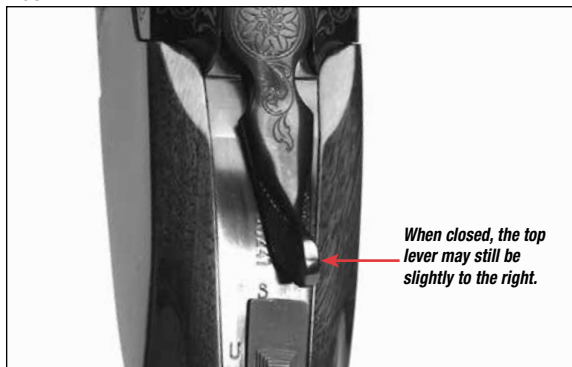
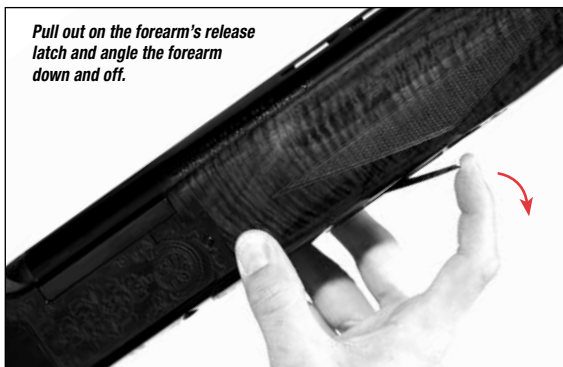

FIGURE 13



ASSEMBLY

⚠WARNING

ALWAYS KEEP THE MUZZLES POINTED IN A SAFE DIRECTION. BEFORE STARTING ASSEMBLY PROCEDURES, VISUALLY INSPECT THE CHAMBERS TO BE ABSOLUTELY CERTAIN THE FIREARM IS COMPLETELY UNLOADED. PLACE THE "SAFETY" IN THE ON SAFE POSITION. FAILURE TO FOLLOW THIS WARNING COULD RESULT IN SERIOUS INJURY OR DEATH.

Your shotgun will come from the factory partially disassembled. Prior to assembly clean and lightly lubricate component parts as explained under "Initial Cleaning and Lubrication" (pages 10-11).

It is important to carefully follow the assembly instructions below to ensure proper assembly of your shotgun.

1. Inspect the chambers and action areas, and clean dirt and/or excess lubricant from them as explained on pages 10-11.
2. Remove the forearm from the barrels by holding the barrels with one hand and pull out on the forearm release latch with the other (Figure 13, page 14).
3. Attach the barrels (without the forearm attached to them) to the action by first holding the barrels with the muzzles at a downward angle with respect to the receiver. Then push the top lever to the right. Carefully engage the surfaces of the trunnions (located

FIGURE 14

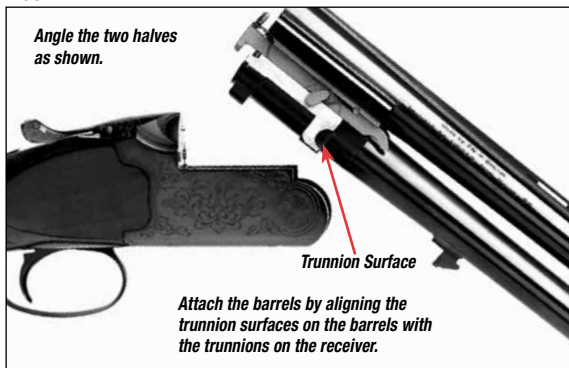

inside the forward portion of the receiver) with the curved trunnion surfaces on the monoblock, located on each side of the bottom barrel (Figure 14, page 15).

4. With the monoblock properly seated on the trunnions, lift up on the barrels and close the action. Make sure the monoblock and trunnions remain in proper alignment. When performing assembly procedures it also helps to keep the top lever pushed fully to the right with your thumb until the action is closed. When the action is fully closed release the top lever and the action will be locked in the closed position.

If the action seems difficult to close, the monoblock and trunnions may not be properly engaged. Release the upward pressure and carefully separate the barrels

FIGURE 15

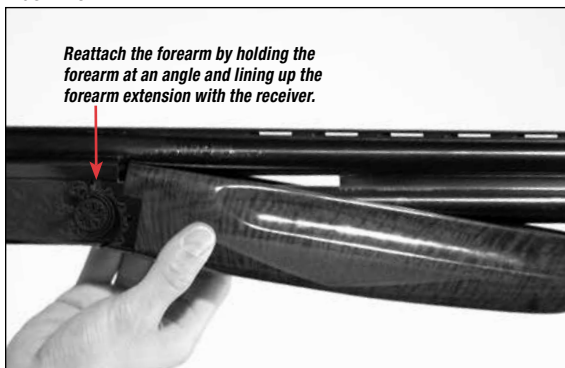

from the action again. If forced, you may mar and damage the fine fit of your shotgun's action.

5. Once the barrels are installed and the action closed, replace the forearm on the shotgun by sliding the radiused rear surface of the forearm extension at an angle into the radiused front edge of the receiver. Match the shape of the rear of the forearm to the shape of the front of the receiver (Figure 15, page 15). Lift the front of the forearm until it engages with the barrels with an audible click. If it does not click, gently slap the forearm just above the latch with the palm of your hand. If the forearm release latch protrudes carefully push it into place, but do not force the latch. Your shotgun is now fully assembled.

DISASSEMBLY

⚠️WARNING

ALWAYS KEEP THE MUZZLES POINTED IN A SAFE DIRECTION. BEFORE STARTING DISASSEMBLY PROCEDURES, OPEN THE ACTION AND VISUALLY INSPECT THE CHAMBERS TO BE ABSOLUTELY CERTAIN THE FIREARM IS COMPLETELY UNLOADED. PLACE THE "SAFETY"/SELECTOR IN THE ON SAFE POSITION. FAILURE TO FOLLOW THIS WARNING COULD RESULT IN SERIOUS INJURY OR DEATH.

Disassembling your shotgun into its two assembly components is an ideal way to ready your shotgun for storage and cleaning. Many luggage-style cases require doing this. It is also a way to add an extra measure of safety when storing your firearm.

1. Make sure your shotgun is unloaded and make sure that the "safety"/selector is in the on safe position.
2. Remove the forearm by pulling outward on the forearm release latch and pulling the forearm away from the barrels. Pull the front-most end of the forearm away and slightly forward, completely detaching it from the barrel set and the front of the receiver.

NOTICE

USE CARE WHEN REMOVING THE FOREARM. DO NOT PULL DOWN TOO HARD ON THE FOREARM OR PULL IT

FIGURE 16



AWAY FROM THE BARRELS TOO FAR. DOING SO MAY CRACK THE FOREARM.

3. Grasp the barrels ahead of the receiver and push the top lever to the right with your thumb. Rotate the barrels downward until they separate from the receiver. Be sure to support the barrels and buttstock carefully. When the barrels are fully down, carefully lift the hinge portion of the barrels (at the receiver) upward out of the receiver, separating the barrels from the receiver (Figure 16, page 16).
4. If you are cleaning your shotgun, this is the ideal level of disassembly.
5. When cleaning is completed, reattach the forearm to the barrels for storage. This is done very easily when

FIGURE 17

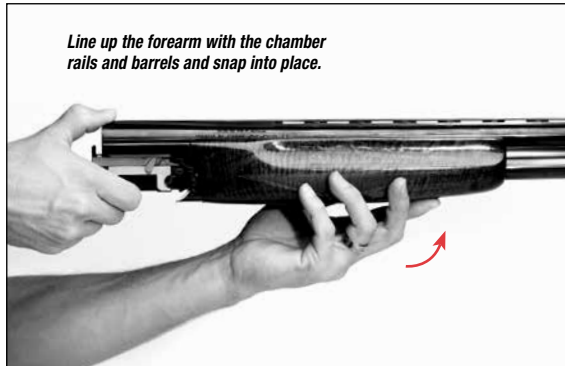

the barrels are detached. Simply align the forearm extension along the bottom of the barrel so that the forearm extension aligns with the rails on each side of the chambers. Make sure the ends of the rails line up with the rear top edge of the forearm (Figure 17, page 17). The forearm can be angled slightly or positioned parallel with the barrels. Press with even pressure using both hands, front to back, along the forearm. As the forearm snaps into position, the release latch may briefly protrude from the bottom of the forearm. It will snap down flush with the forearm when it is secured in position correctly.

AMMUNITION

⚠WARNING

DISCHARGING FIREARMS IN POORLY VENTILATED AREAS, CLEANING FIREARMS OR HANDLING AMMUNITION MAY RESULT IN EXPOSURE TO LEAD AND OTHER SUBSTANCES KNOWN TO CAUSE BIRTH DEFECTS, REPRODUCTIVE HARM AND OTHER SERIOUS PHYSICAL INJURY. HAVE ADEQUATE VENTILATION AT ALL TIMES. WASH HANDS THOROUGHLY AFTER EXPOSURE.

USE ONLY SHELLS OF THE CORRECT GAUGE AND LENGTH. THE GAUGE AND LENGTH OF THE CHAMBER IS INSCRIBED ON THE SIDE OF THE BARREL. DO NOT USE AMMUNITION OTHER THAN WHAT IS INSCRIBED ON THE SIDE OF THE BARREL. EXAMINE EVERY SHELL YOU PUT IN YOUR SHOTGUN. FAILURE TO FOLLOW THIS WARNING COULD RESULT IN SERIOUS INJURY OR DEATH AND CAUSE DAMAGE TO YOUR SHOTGUN.

USE SHELLS OF THE CORRECT LENGTH. DO NOT USE 3" OR 3½" SHELLS IN A BARREL WITH A 2¾" OR 2½" CHAMBER, OR 3½" SHELLS IN A BARREL WITH A 3" CHAMBER. DOING SO CAN RESULT IN A BUILDUP OF DANGEROUSLY HIGH PRESSURES. FAILURE TO FOLLOW THIS WARNING COULD RESULT IN SERIOUS INJURY OR DEATH AND CAUSE DAMAGE TO YOUR SHOTGUN.

DO NOT PUT A 16 GAUGE SHELL OR A 20 GAUGE SHELL IN A 12 GAUGE SHOTGUN. DO NOT PUT A 28 GAUGE SHELL IN A 20 GAUGE SHOTGUN. DO NOT PUT A .410 BORE SHELL IN A 28 GAUGE SHOTGUN. NEVER PUT METALLIC CARTRIDGES OF ANY KIND IN A SHOTGUN. SPECIFICALLY, NEVER PUT CENTERFIRE RIFLE OR PISTOL CARTRIDGES IN A SHOTGUN CHAMBERED FOR .410 BORE. FAILURE TO FOLLOW THIS WARNING COULD RESULT IN SERIOUS INJURY OR DEATH AND CAUSE DAMAGE TO YOUR SHOTGUN.

The most certain way to bulge or rupture a shotgun barrel is to load a smaller gauge shell into a larger gauge chamber. The smaller gauge shell will not fall completely through the barrel; its rim is caught by the front of a larger gauge chamber or at the larger gauge's choke. Your shotgun will misfire (with the chamber appearing to be empty). It is then possible to load the correct gauge shell behind the smaller gauge shell. If the shotgun is then fired, the result will be a so-called "12-16, 12-20, 20-28 or 28-.410 burst" which can cause extensive damage to your shotgun and possible serious injury to you and others.

The barrels and action of this firearm have been made with safety margins over the pressures established by the Sporting Arms and Ammunition Manufacturers' Institute (SAAMI) for Service Cartridges. However, we assume no responsibility for incidents which occur through the use of cartridges of nonstandard dimension or those developing pressures in excess of SAAMI established standards.

There are several different versions of the Model 101. The gauge and chamber length are inscribed on the side of the barrel, forward of the receiver. They are inscribed as follows:

- 2¾" and 3" chamber — These models are designed to shoot all factory loads from 2¾" up to 3" Magnums. (It is not designed to shoot 3½" shells.)
- 2¾" chamber — These models are designed to shoot all factory 2¾" loads from the lightest target loads to heavy 2¾" hunting field loads. (2¾" target models are not designed to shoot 3" or 3½" shells.)

Winchester® ammunition is always an excellent choice for your new Winchester firearm, delivering the unmatched performance and dependability you want.

LOADING

▲WARNING

WHEN LOADING YOUR SHOTGUN ALWAYS KEEP THE MUZZLES POINTED IN A SAFE DIRECTION, ALWAYS PLACE THE "SAFETY" IN THE ON SAFE POSITION AND KEEP YOUR FINGERS AWAY FROM THE TRIGGER. FAILURE TO FOLLOW THESE WARNINGS COULD RESULT IN SERIOUS INJURY OR DEATH.

DO NOT CARRY YOUR SHOTGUN WITH SHELLS IN THE CHAMBERS TO AVOID ACCIDENTAL DISCHARGE. WHEN FIRING IS NO LONGER IMMINENT, MAKE SURE THE

FIGURE 18



“SAFETY” IS IN THE ON SAFE POSITION AND UNLOAD THE CHAMBERS. FAILURE TO FOLLOW THESE WARNINGS COULD RESULT IN SERIOUS INJURY OR DEATH.

1. Make sure the “safety”/selector is in the on safe position.
2. Open the action by pushing the top lever to the right with the thumb of your right hand. Left-handed shooters usually push the lever by reaching across with their left thumb.
3. Visually check to make sure there are no obstructions in the chambers or bores of the barrels.

FIGURE 19

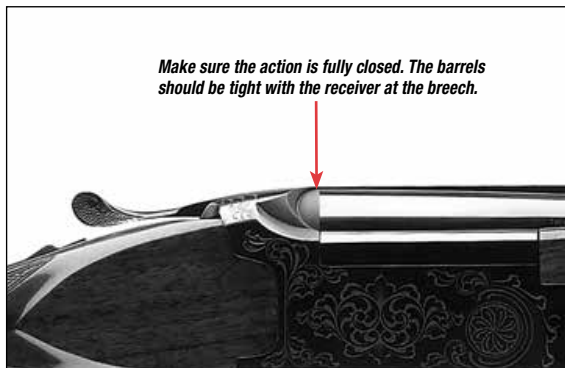

4. Insert a shell in each chamber or in the chamber you plan to fire. Make sure the shell(s) are fully forward in the chamber(s), with the rim(s) in direct contact with the edge of the extractors/ejectors (Figure 18, page 19).
5. Close the action by lifting up on the forearm, hinging the barrels upward into position, until the action is fully closed. When closed, the top lever will snap back into the center position. There should be no space between the face of the barrels and the face of the receiver when the action is fully closed (Figure 19, page 19).

▲WARNING

THE SHOTGUN IS NOW READY TO FIRE BY SIMPLY MOVING THE “SAFETY” TO THE OFF SAFE POSITION AND PULLING THE TRIGGER.

6. Select the barrel you want to fire first by operating the barrel selector which is an integral part of the “safety”/selector. The “safety”/selector must be in the rearward, on safe position to be able to select the firing order of your barrels. Refer to the instructions under “Barrel Selector” on pages 12-13.

FIRING

▲WARNING

NEVER LOAD SHELLS INTO THE CHAMBERS UNLESS SHOOTING IS IMMINENT. ALWAYS KEEP THE MUZZLES POINTED IN A SAFE DIRECTION. FAILURE TO FOLLOW THESE WARNINGS COULD RESULT IN SERIOUS INJURY OR DEATH.

1. Make sure the “safety”/selector is in the on safe position.
2. Load the shotgun as explained previously. With shells in the chambers and the action closed, you need only move the “safety” to the off safe position to fire the shotgun.

▲WARNING

THE SHOTGUN IS NOW READY TO FIRE BY SIMPLY MOVING THE “SAFETY” TO THE OFF SAFE POSITION AND PULLING THE TRIGGER.

3. When shooting is imminent, move the “safety”/selector to the off safe position. Take aim and, when ready, squeeze the trigger to fire. After firing one barrel, it is not necessary to move the “safety”/selector to fire the second barrel. Simply release the trigger to its original forward position and pull it a second time. Be certain you fully release the trigger between shots. If the trigger is not permitted to return to its fully forward position, the firing mechanism will not reengage and the subsequent trigger pull will fail to fire the remaining shell. Failure to release the trigger ordinarily occurs with overly rapid firing or heavily gloved fingers.
4. After you have completed firing you should either reload the chamber(s) with unfired shells (if hunting/shooting is going to continue) or fully unload your shotgun (if shooting is completed). Regardless, always first place the “safety”/selector in the on safe position. Be sure to open the action completely between shots to reset the firing mechanism.

⚠️WARNING

AFTER FIRING, OR WHEN SHOOTING IS NO LONGER IMMINENT, IMMEDIATELY PLACE THE “SAFETY” IN THE ON SAFE POSITION. FAILURE TO FOLLOW THIS WARNING COULD RESULT IN SERIOUS INJURY OR DEATH.

For training purposes or in some target situations your firearm can be fired “single shot” by loading one shell at a time in only one of the chambers. For training new shooters, the bottom barrel is often used because of its slightly lower perceived recoil. Make sure the “safety”/selector is set for the barrel you want to fire.

UNLOADING

⚠️WARNING

WHILE UNLOADING YOUR SHOTGUN ALWAYS PLACE THE “SAFETY” IN THE ON SAFE POSITION. KEEP THE MUZZLES POINTED IN A SAFE DIRECTION, AND YOUR FINGERS AWAY FROM THE TRIGGER. FAILURE TO FOLLOW THESE WARNINGS COULD RESULT IN SERIOUS INJURY OR DEATH.

ALWAYS INSPECT THE CHAMBERS AND BARRELS CAREFULLY AFTER UNLOADING TO BE SURE ALL LIVE SHELLS ARE CLEARED FROM THE FIREARM.

The ejector/extractor mechanism mechanically adapts to whether there is a fired shell or a loaded shell in a chamber. With a loaded shell the mechanism acts as an extractor, elevating the shells in the chamber. With a fired shell it acts as an ejector, forcefully ejecting the empty shell clear of the chamber and onto the ground.

1. Using your thumb, move the top lever fully to the right to open the action. The action must be opened completely to reset the firing mechanism. Due to tight manufacturing tolerances, it may be necessary to pull downward slightly on the forearm to completely open the breech. For proper ejection, keep the receiver level and allow the barrels to completely drop. This keeps empty hulls in full contact with the ejectors.
2. It is important to point the breech, by canting the shotgun to the right (or to the left for left-handed shooters), so empty hulls eject clear of your body and face. Fired shells will be thrown completely out of the shotgun upon opening the action. Remember to pick up all of your empty shells after you have finished shooting.

Unfired shells will be elevated in the chambers by the extractors. They can be unloaded from your shotgun by pulling the unfired shell(s) out of the chambers with your fingers.

If only one barrel has been fired, only the fired hull will be ejected upon opening of the action. If shooting is imminent, a loaded shell can be inserted in its place.

INTERCHANGEABLE CHOKE TUBE SYSTEM

⚠WARNING

NEVER ATTEMPT TO REMOVE OR INSTALL A CHOKE TUBE IN A LOADED FIREARM. WHENEVER REMOVING OR INSTALLING A CHOKE TUBE IN A SHOTGUN ALWAYS KEEP THE MUZZLES POINTED IN A SAFE DIRECTION. OPEN THE ACTION AND MAKE ABSOLUTELY CERTAIN THE SHOTGUN IS COMPLETELY UNLOADED, ALWAYS PLACE THE “SAFETY” IN THE ON SAFE POSITION AND KEEP YOUR FINGERS AWAY FROM THE TRIGGER. FAILURE TO FOLLOW THESE WARNINGS COULD RESULT IN SERIOUS INJURY OR DEATH.

⚠CAUTION

INVECTOR-PLUS, STANDARD INVECTOR AND WINCHOKE CHOKE TUBES ARE NOT INTERCHANGEABLE. DO NOT USE INVECTOR-PLUS, STANDARD INVECTOR OR WINCHOKE CHOKE TUBES IN ANY SHOTGUN BARREL NOT SUPPLIED BY WINCHESTER REPEATING ARMS. DO NOT USE ANY OTHER CHOKING DEVICE IN ANY SHOTGUN BARREL SUPPLIED BY WINCHESTER REPEATING ARMS.

USE ONLY THE APPROPRIATE GAUGE AND TYPE OF CHOKE TUBE, MARKED INVECTOR-PLUS, STANDARD INVECTOR OR WINCHOKE, IN THIS SHOTGUN. DO NOT FIRE THIS SHOTGUN WITHOUT THE CORRECT CHOKE TUBE INSTALLED. DAMAGE MAY RESULT TO THE THREADS INSIDE THE BARREL.

FAILURE TO FOLLOW THIS INFORMATION COULD RESULT IN DAMAGE TO YOUR SHOTGUN OR POSSIBLE INJURY.

NOTICE

USE ONLY THE CHOKE TUBE WRENCH SUPPLIED WITH YOUR SHOTGUN TO INSTALL AND REMOVE CHOKE TUBES. USING ANY OTHER WRENCH MAY DAMAGE THE THREADS IN THE BARREL.

All Model 101 shotgun barrels are threaded to accept the Invector-Plus™ choke system. Standard Invector, WinChoke and Invector-Plus tubes are not interchangeable. Confirm the choke system of your shotgun by looking on the right side of the barrel where the specifications are inscribed, where the choke markings are normally located.

The constriction of each choke tube is indicated twice on the choke tube: On the side of the tube, and indicated with a “notch” code on the top rim of the tube. The included choke tube wrench is used to remove and install choke tubes.

Some target shotguns include premium extended choke tubes. The constriction of premium choke tubes is indicated twice on the choke tube: On the side of the tube, and indicated with an abbreviation in the colored band. The constriction of flush fit choke tubes is indicated twice on the choke tube: On the side of the tube, and indicated with a “notch” code on the top rim

of the tube. The included choke tube is used to remove and install extended choke tubes.

Choke tubes are compatible with factory ammunition that has been loaded in compliance with SAAMI specifications, including magnum lead and steel shot loads, sabots and shotgun slug loads.

Replacement and additional tubes and wrenches are available from your Winchester Repeating Arms dealer, or by contacting the Winchester Repeating Arms Customer Service Department. See page 32 for contact information.

CHOKE TUBE SELECTION

To help you choose the correct choke tube for each hunting and shooting situation, all Invector-Plus choke tubes are inscribed on the side with the patterns they produce with both lead and steel shot. Each Invector-Plus tube also has notches in the top rim of the tube (Figure 20, page 23). These notches are a code to allow you to determine the choke designation while the tube is installed. Rim notches refer specifically to lead shot. Use the charts on this page to cross-reference from lead to steel, and determine the appropriate tubes for your ammunition and hunting/shooting situation.

Several choke tubes are supplied with your shotgun. The choke tubes listed are also available as accessories. Remember, WinChoke, Standard Invector and Invector-Plus tubes are not interchangeable. Before removing or installing tubes, or reading the rim notch code, make sure your shotgun is completely unloaded and the “safety” is in the on safe position.

FIGURE 20

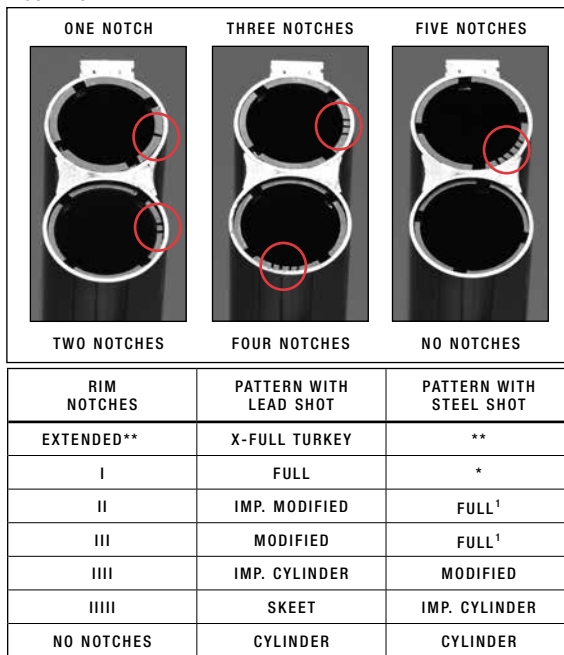

* Not for use with steel shot. Using an over-tight choke constriction with steel shot will result in an ineffective “blown” pattern.

** Extra Full Turkey, extended with ports. Do not use with steel shot.

¹ When more than one choke tube is listed for a given steel shot pattern, use the more open choke listed for high velocity, larger shot size steel loads.

CHOKE TUBE REMOVAL

1. Place the “safety”/selector in the on safe position. Always make sure the shotgun is completely unloaded. Always keep the muzzles pointed in a safe direction.
2. Use the choke tube wrench to loosen the tube, turning it counterclockwise. Finger-twist the tube the rest of the way out of the barrel.

CHOKE TUBE INSTALLATION

1. Place the “safety”/selector in the on safe position. Always make sure the shotgun is completely unloaded. Always keep the muzzles pointed in a safe direction.
2. Before installing a tube, check the internal choke tube threads in the muzzle, as well as the threads on the choke tube to be sure they are clean. Lightly oil the threads with a high-quality, lightweight gun oil.

NOTICE

FAILURE TO CLEAN AND OIL THE THREADS ON THE CHOKE TUBE COULD RESULT IN THE CHOKE TUBE SEIZING IN THE BARREL.

3. Using your fingers, screw the appropriate tube into the muzzle of the barrel, tapered end first, notched end outward. When it becomes finger-tight, use the included choke tube wrench to firmly seat the tube.

NOTICE

THE CHOKE TUBES SHOULD BE PERIODICALLY CHECKED TO ENSURE THEY ARE TIGHT AND FIRMLY SEATED. BEFORE CHECKING, FOLLOW ALL CHOKE TUBE REMOVAL AND INSTALLATION “SAFETY”/SELECTOR GUIDELINES PREVIOUSLY OUTLINED.

CHANGING LENGTH OF PULL (SPECIAL MODELS)

▲WARNING

BEFORE CHANGING TRIGGERS OR PERFORMING ADJUSTMENT PROCEDURES, PLACE THE “SAFETY” IN THE ON SAFE POSITION. OPEN THE ACTION AND MAKE CERTAIN THE CHAMBERS ARE UNLOADED. KEEP THE MUZZLES POINTED IN A SAFE DIRECTION. FAILURE TO FOLLOW THESE WARNINGS COULD RESULT IN SERIOUS INJURY OR DEATH.

Some shotguns are fitted with a special trigger shoe system that allows you to make small adjustments to the length of pull. This feature is usually found on target models where shooters benefit from highly customized settings. It is easy to change the length of pull using the 1.5mm Allen (hex style) wrench included with your firearm.

1. Place your firearm upside down on a secure, padded surface to prevent marring the finish.

FIGURE 21

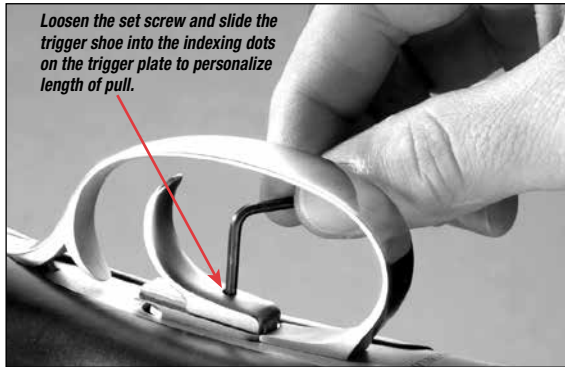

2. Using a 1.5mm Allen wrench, loosen the trigger shoe from the trigger plate by inserting the wrench from the bottom into the set screw head (Figure 21, page 25). Turn in a counterclockwise direction to loosen.
3. When the screw is sufficiently loose you will be able to move the trigger shoe along the trigger plate with your fingers. There are indexing dots on the trigger shoe and on the plate. Line up the dots to make length of pull longer or shorter as desired.
4. Tighten the set screw snugly (do not overtighten) with the Allen wrench to secure the trigger shoe to the plate (turn in a clockwise direction to tighten). Make sure you have aligned the indexing dots in

order to prevent marring the bottom of the trigger plate with the set screw.

5. With your firearm unloaded, and pointed in a safe direction, shoulder your firearm several times to feel how the adjustment changes fit you. Increase or decrease the length of pull following the previous instructions if necessary. Do not adjust more than allowed by the “dot” index marks on the plate and trigger shoe. When you find your preferred adjustment, tighten the set screw. Always make sure the trigger shoe is secure before firing. Checking the tightness of the set screw should be part of your regular maintenance.

ADJUSTABLE STOCK (SPECIAL MODELS)

▲WARNING

BEFORE PERFORMING STOCK ADJUSTMENT PROCEDURES, PLACE THE “SAFETY” IN THE ON SAFE POSITION. OPEN THE ACTION AND MAKE CERTAIN YOUR SHOTGUN IS COMPLETELY UNLOADED. KEEP THE MUZZLES POINTED IN A SAFE DIRECTION. FAILURE TO FOLLOW THESE WARNINGS COULD RESULT IN SERIOUS INJURY OR DEATH.

Some shotguns are fitted with an adjustable stock that allows you to make adjustments to the stock for cast and drop. This feature is usually found on target models where shooters benefit from highly customized settings.

FIGURE 22

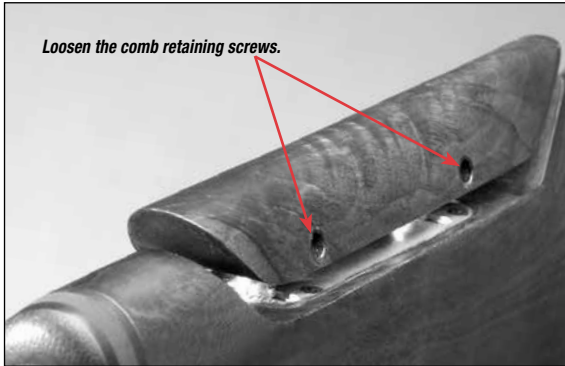
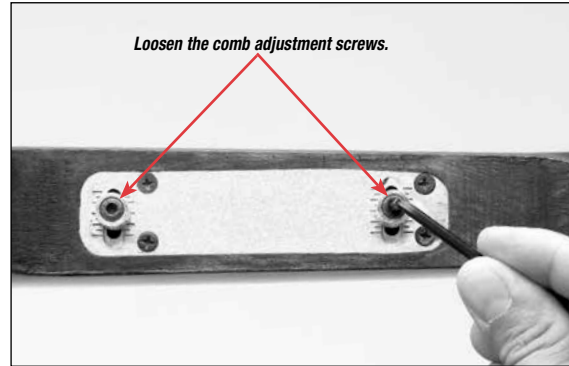

FIGURE 23



ADJUSTING CAST ON AND CAST OFF

Adjusting cast on and cast off allows you to achieve a perfect fit from the stock to your face. This is a most crucial adjustment, as it determines how correctly and consistently your eye will line up with the sight plane along the barrel rib. A shotgun correctly adjusted for cast on and cast off will have you looking directly down the center of the rib with the front and middle beads in alignment.

1. Using a 3mm Allen (hex style) wrench, loosen the two comb retaining screws on the right side of the removable cheekpiece and remove the cheekpiece by lifting upward (Figure 22, page 26). This exposes the cast on and cast off adjustment mechanism.

(The cheekpiece comes set from the factory with cast in the center position.)

2. Loosen both the comb adjustment stud screws located in the top of the stock adjustment studs using a 3mm Allen wrench (Figure 23, page 26). It only takes a fractional $\frac{1}{4}$ turn to loosen them adequately.
3. Slide each stud equally in the desired direction. Each mark indicates $\frac{1}{16}$ ".
4. Move the studs to the right for cast off (Figure 24, page 27).
5. Move the studs to the left for cast on (Figure 25, page 27).

FIGURE 24



FIGURE 25



6. Right-handed shooters may desire some cast off, with left-handed shooters preferring some cast on. The terminology is the same for right- or left-handed shooters. The net effect is to move the cheekpiece to allow the face to move farther over the stock for better eye-to-rib alignment.
7. When properly set, the front and rear sight beads should line up perfectly each time you shoulder your shotgun.
8. Tighten the stock adjustment screws. Be careful not to overtighten.
9. Replace the cheekpiece onto the studs. If drop at comb has already been set to your desired height, tighten the two comb retaining screws securely.

If drop has not been set, leave the retaining screws loose and proceed to “Adjusting Drop at Comb.”

ADJUSTING DROP AT COMB

Adjusting the drop at the comb allows you to align your eye perfectly with the plane of the rib.

The drop measurement is determined by measuring the distance between the plane formed by the top of the rib and the top of the cheekpiece itself. The higher the cheekpiece, the lower the drop. To set drop, perform the following:

1. Loosen the two stock adjustment set screws on the right side of the cheekpiece (if they were not left loose after setting the cast) using a 3mm Allen wrench. The cheekpiece will now move freely, up and down on the stock adjustment studs.
2. Position the cheekpiece on the studs at the desired drop up or down on the stock. Make sure the adjustment on each stud is equal up and down. When you have determined a possible setting, lightly tighten the stock adjustment screws and then shoulder the firearm to test the setting. Drop adjustments are a matter of trial and error. Adjust a little at a time until you obtain the desired sight picture on the rib.
3. Once your desired drop at comb is obtained, secure the cheekpiece in place by tightening the two stock adjustment set screws on the right side of the cheekpiece. Drop is now set on your shotgun.

BARREL PORTING (SPECIAL MODELS)

Some target models feature ported barrels that reduce recoil and muzzle jump. Reducing recoil not only increases comfort when shooting, but increases accuracy because it is easier to pick-up the second clay target faster due to decreased recovery time following the first shot. Carbon can build up in the ports after shooting. To clean them use a good quality powder solvent and pipe cleaners to scrub away debris.

⚠WARNING

BARREL PORTING INCREASES NOISE AND MUZZLE BLAST. ALWAYS WEAR HEARING PROTECTION, AND INSTRUCT BYSTANDERS TO WEAR HEARING PROTECTION, TO PREVENT HEARING LOSS OR DAMAGE.

MAINTENANCE OF OIL FINISH STOCKS

Keeping the oil-finished wood surfaces on your firearm looking their best requires only a small amount of maintenance. When the surfaces become spotted or dull, the affected area(s) can be treated using rubbing alcohol on a soft, lint free cloth and allowed to dry. A small amount of a linseed oil-based finish, such as Watco® Danish Oil Finish, Deft® Danish Oil Finish, or Formby's® Tung Oil Finish should then be applied to the surface of the wood with a soft, lint free cloth according to the manufacturers' instructions. To treat the checkering, a small amount of oil-based finish can be applied and then distributed evenly using a toothbrush or other soft bristled brush.

MODELS WITH SPECIAL FINISHES

As with any firearm, the only way to preserve its pristine condition and collector appeal is to never handle or fire it, which in turn would deprive you of much of the enjoyment that comes with owning a fine Winchester firearm.

While special finishes such as engraving and gold plating greatly enhance the aesthetic appeal of your shotgun, please be aware that they are no more durable, and in some cases may even be slightly less durable than more common firearm finishes.

As you use your Winchester shotgun, you can expect special finishes to wear in much the same manner as any other firearm finish. These marks are the honest product of the hours spent enjoying your firearm and each scuff and scratch will probably have a good story to go along with it.

CLEANING AND MAINTENANCE SUGGESTIONS

⚠WARNING

BEFORE PERFORMING CLEANING PROCEDURES, PLACE THE "SAFETY" IN THE ON SAFE POSITION. OPEN THE ACTION AND MAKE CERTAIN YOUR SHOTGUN IS COMPLETELY UNLOADED. KEEP THE MUZZLES POINTED IN A SAFE DIRECTION. FAILURE TO FOLLOW THESE WARNINGS COULD RESULT IN SERIOUS INJURY OR DEATH.

⚠WARNING

WEAR EYE PROTECTION WHEN DISASSEMBLING AND CLEANING YOUR SHOTGUN TO PREVENT SPRINGS, SPRING-LOADED PARTS, SOLVENTS OR OTHER AGENTS FROM CONTACTING YOUR EYES, RESULTING IN INJURY.

⚠WARNING

KEEP ALL AMMUNITION AWAY FROM THE CLEANING AREA. NEVER TEST THE MECHANICAL FUNCTION OF YOUR SHOTGUN WITH LIVE AMMUNITION. FAILURE TO FOLLOW THESE WARNINGS COULD RESULT IN SERIOUS INJURY OR DEATH.

NOTICE

SOME CLEANING SOLVENTS, LUBRICANTS AND OTHER STRONG CHEMICALS SUCH AS THOSE FOUND IN DEET-CONTAINING INSECT REPELLENTS, SUNSCREENS, ETC. MAY DAMAGE THE FINISHES OF YOUR FIREARM. USE CARE TO PREVENT CHEMICALS FROM MAKING CONTACT WITH FINISHES WHEN CLEANING THE BORE AND ACTION OF YOUR FIREARM.

CLEANING PROCEDURES

Your Model 101 shotgun will function better and more reliably over a longer period of time if it is properly maintained and kept clean. You should clean your shotgun after every day of shooting, and more often if it becomes excessively dirty. The barrels should be cleaned

and the action wiped clean and lubricated after every day of shooting.

Normal maintenance can be accomplished with the barrels still attached to the receiver (lubricating and wiping down). More careful cleaning requires removal of only the barrels and forearm from the receiver (cleaning the barrel).

If a malfunction occurs, perform a thorough cleaning to see if it solves the problem before seeking the services of a Winchester Repeating Arms Authorized Repair Center, or by contacting the Winchester Repeating Arms Service Facility in Arnold, Missouri, or a qualified gunsmith.

1. Place the “safety” in the on safe position. Open the action and inspect the chambers to make certain they do not contain any shells. Keep the muzzles pointed in a safe direction.
2. Remove the forearm and barrels as explained under “Disassembly” on pages 16-17.
3. Using a shotgun cleaning rod with tip and patch large enough for a snug fit in the bore, insert the rod and a lightly oiled patch in the breech end of the barrel and run back and forth through the bore several times. Remove and wipe the choke tube, threads and barrel threads with a nylon brush and lightly oil. Reinstall the choke tubes.
4. Inspect the bore from both ends for leading and plastic residue that often remain in the bores from the shot cups in modern shotshells. Leading and plastic residue

will appear as longitudinal streaks and are usually more predominant near the muzzles and just forward of the chambers. A normal amount of either is common and not serious.

5. If leading or plastic residue seems excessive you can remove it by brushing the bore with a brass brush. Soak the brush or spray the bore with a powder solvent first. Scrub until clean. To prevent bristles from breaking off, push the brush fully through the barrel each time before pulling it back through.

⚠WARNING

MOST SOLVENTS ARE HIGHLY FLAMMABLE. WEAR EYE PROTECTION AND PRACTICE APPROPRIATE SAFETY MEASURES WHEN WORKING WITH SOLVENTS TO AVOID SERIOUS INJURY.

6. After all leading and plastic residues have been removed, run a clean, dry patch through the bore. Follow this with a final, lightly oiled patch.
7. Wipe all metal surfaces of the receiver, forearm and barrels with a clean rag. Then lubricate your firearm at the points noted on pages 10-11. Regular, light lubrication is extremely important to the durability and reliable operation of your shotgun.

NOTICE

THE FINELY FITTED SURFACES OF THE RECEIVER AND FOREARM MECHANISMS (TRUNNION SURFACES,

BARREL LUG AND FOREARM BRACKET) MUST ALWAYS BE COATED WITH A FILM OF HIGH QUALITY GREASE.

8. Reassemble the shotgun and wipe all exposed metal surfaces with an oiled cloth making sure to wipe away all finger marks where moisture could accumulate.
9. Inspect the barrels and chambers to be certain no patches have inadvertently been left in them. Remove any that remain.
10. The wood surfaces can also be wiped with a quality, lightweight gun oil or they can be polished with any quality furniture wax (but not both).

NOTICE

IT IS VERY IMPORTANT THAT THE CHAMBERS OF YOUR SHOTGUN BE CLEANED THOROUGHLY AND PROMPTLY AFTER SHOOTING PLASTIC SHOTSHELLS. DO NOT LEAVE DISCHARGED (EMPTY) SHELLS IN THE CHAMBERS FOR ANY LENGTH OF TIME. THE CHEMICAL COMPOSITION OF MANY PLASTIC SHELLS CONTAINS MOISTURE WHICH CAN “SWEAT” OUT OF THE SHELL AND ONTO THE CHAMBERS’ SURFACES, AND POSSIBLY CAUSE CORROSION AND RUST.

PERIODIC LUBRICATION

The metal parts of a firearm should be lubricated after the firearm has been exposed to weather or handling. Lubricate your firearm at the points described under “Initial Cleaning and Lubrication” found on pages 10-11.

The metal surfaces of the firearm should receive a light film of oil any time the firearm has been exposed to weather or handling. This is very important and must be done with every firearm. Remember, the polished, finely fitted surfaces of the receiver and action mechanisms must always have a thin film of lubrication. Make sure that the surfaces of the locking pin system are especially clean and lightly lubricated with a high-quality gun oil and the hinge surfaces on both sides of the receiver are lightly greased to prevent galling. If the firearm has been exposed to excessive dust, dirt, mud or water, the principal working parts should be wiped clean and lubricated.

NOTICE

DO NOT PLACE LARGE QUANTITIES OF OIL INTO THE ACTION. EXCESS OIL WILL RUN BACK INTO THE WOOD OF THE STOCK SOFTENING THE WOOD, WITH CONSEQUENTIAL LOOSENING OF THE STOCK.

CLEANING THE INVECTOR-PLUS™ CHOKE TUBE SYSTEM

1. Never use a brass brush to clean your barrels unless choke tubes are installed. Bristles could break off and lodge in the threads, making installation and removal of the choke tubes difficult.
2. Regularly remove the choke tubes in order to clean and oil the threads inside the barrel, as well as on the choke tube itself. This will protect the threads from being damaged and also prevent a dirt build-up that would cause the choke tube to become difficult to

remove. Clean the threads with solvent and a small, soft brush like a toothbrush. Wipe completely clean and leave a thin film of clean oil on the threads, both on the tube and in the barrel. The threads of the choke tube and the internal threads of the barrel should be cleaned after each use and before the installation of a tube.

3. Be careful when removing/installing a tube. Use the specially designed wrench. Damage can result to both choke tube and barrel when attempting to remove sticky choke tubes.
4. Never fire your shotgun or run cleaning tools through the barrel of any choke-tubed shotgun without having the choke tubes installed.

NOTICE

NEVER ATTEMPT TO TAKE YOUR FIREARM APART FURTHER THAN EXPLAINED IN THIS OWNER'S MANUAL. YOUR FIREARM IS A SPECIALIZED, FINELY FITTED MECHANISM. YOU MAY PERMANENTLY DAMAGE IT BY ATTEMPTING TO DISASSEMBLE THE INNER MECHANISM. IF FURTHER DISASSEMBLY FOR SERVICE OR CLEANING IS REQUIRED, TAKE YOUR FIREARM TO A QUALIFIED GUNSMITH, OR CONTACT OUR ARNOLD, MISSOURI SERVICE FACILITY AS EXPLAINED UNDER "PARTS, SERVICE, REPAIR AND QUESTIONS" ON PAGE 32.

OTHER SUGGESTIONS

- After extended periods of heavy use, your shotgun should be taken to a qualified gunsmith to have the action disassembled for professional cleaning and lubrication.

PARTS, SERVICE, REPAIR AND QUESTIONS

If your Winchester firearm should require service or repair, we suggest first contacting a Winchester Repeating Arms Authorized Repair Center. To locate an Authorized Repair Center visit winchesterguns.com, contact our customer service department or ask your local Winchester Repeating Arms dealer. You may also send your firearm to the Winchester Repeating Arms Service Facility in Arnold, Missouri. In order to avoid service delays, do not send your firearm directly to our service facility without authorization from one of our service specialists.

Parts listings, a list of Authorized Repair Centers, service procedures, service/repair form and general product information are on the web at winchesterguns.com.

When returning your firearm for service, you must do the following:

1. Be sure it is completely unloaded.
2. Remove any optics, optic mounts or other accessories.

3. Package it securely in a cardboard container.
4. Enclose the service/repair form available at winchesterguns.com or a letter that clearly describes the trouble experienced, the ammunition used and the repairs desired. Also include your name, email address (if possible) and a daytime phone number where you can be reached.
5. Never return ammunition with your firearm. It is against postal and most commerce regulations.

PARTS, SERVICE, REPAIR STATUS AND TECHNICAL QUESTIONS

**Winchester Repeating Arms
Parts and Service**
3005 Arnold Tenbrook Road
Arnold, MO 63010-9406
(800) 322-4626

GENERAL PRODUCT AND HISTORICAL QUESTIONS

**Winchester Repeating Arms
Customer Service**
275 Winchester Avenue
Morgan, UT 84050-9333
(800) 945-5237
customersupport@winchesterguns.com

⚠WARNING

PARTS ARE MADE FOR WINCHESTER BRAND FIREARMS MANUFACTURED BY OR FOR WINCHESTER REPEATING ARMS, AND SHOULD NOT BE USED IN OTHER FIREARMS, EVEN THOUGH MODELS MAY BE SIMILAR. IMPROPERLY FITTED PARTS MAY BE DANGEROUS. FAILURE TO FOLLOW THIS WARNING MAY CAUSE INJURY OR DEATH AND CAUSE DAMAGE TO YOUR FIREARM.

WEBSITE INFORMATION

An information resource for Winchester Repeating Arms can be found online at winchesterguns.com.

- List of Authorized Repair Centers.
- Customer Service information.
- Firearm Service/Repair Form.
- Answers to many technical and historical questions.
- Links to helpful sites.



Winchester Repeating Arms

275 Winchester Avenue

Morgan, UT, U. S. A. 84050-9333

winchesterguns.com

AO2011/20322

Winchester is a registered trademark of Olin Corporation.