



**FN SCAR®
20S**

**AUTOLOADING RIFLE
WITH NON-RECIPROCATING CHARGING HANDLES
OWNER'S MANUAL**

Important operating instructions for:

FN SCAR® 20S AUTOLOADING RIFLES WITH NON-RECIPROCATING CHARGING HANDLES

If you have any questions or comments regarding your new firearm, please contact us:

FN Service Center
797 Old Clemson Road
Columbia, SC 29229

(800) 635-1321
customerservice@fnamerica.com
www.fnamerica.com

Please use the space below to record information about your new firearm.

Model _____

Serial Number _____

Purchased From _____

Date of Purchase _____

© 2021 FN America, LLC All Rights Reserved

CONTENTS

1. Foreword.....	2	5.1. Description.....	16
2. Contents of the Storage Case.....	3	5.2. Operation.....	16
3. Safety and Warnings.....	4	6. Nomenclature.....	17
4. Firearm Safety Information.....	6	7. Serial Number.....	17
5. Description and Operation.....	14	8. Initial Cleaning.....	17

9. Operation of the Safety Selector.....	18	19.3. Removal of the Moving Parts Assembly	35
10. Bolt Release.....	19	19.4. Disassembly of the Moving Parts Assembly	37
10.1. Bolt Release Function.....	19	19.5. Removal of the Gas Regulator and Gas Piston.....	38
10.2. Bolt Lock Function	20	20. Cleaning and Lubrication.....	40
11. Ammunition	20	20.1. Cleaning Procedures	40
12. Magazine Capacity	21	20.2. Cleaning the Trigger Module	43
13. Loading	21	20.3. Cleaning the Magazine.....	44
13.1. Filling the Magazine	22	21. Assembly.....	44
13.2. Loading the Chamber from the Magazine.....	23	21.1. Installation of the Gas Piston and Gas Regulator.....	44
14. Firing	24	21.2. Assembling the Moving Parts Assembly	45
14.1. Firing Procedures	24	21.3. Installation of the Moving Parts Assembly	46
14.2. Adjusting the Gas Regulator...26		21.4 Installation of the Buttstock Module.....	47
14.3. Malfunctions	28	21.5 Installation of the Trigger Module	47
15. Unloading.....	28	21.6. Function Check	50
15.1. Unloading the Rifle.....	29	22. Taking Care of the Rifle.....	50
15.2. Unloading the Magazine.....	30	23. Warranty, Service and Technical Questions.....	51
16. Buttstock Module.....	30	24. Technical Specifications.....	53
16.1. Adjusting the Buttstock for Length of Pull (LOP).....	31		
16.2. Adjusting the Cheek Rest Height	31		
17. Mounting Optics and Sights.....	32		
18 Mounting Accessories.....	32		
19. Disassembly.....	33		
19.1. Removal of the Trigger Module	34		
19.2. Removal of the Buttstock Module.....	35		

1. FOREWORD

We are pleased that you have chosen an FN SCAR 20S autoloading rifle. The FN SCAR 20S with Non-Reciprocating Charging Handles (NRCH) combines the latest in autoloading rifle design, manufacture and testing methods to create a rifle worthy of the operators of the U.S. Military's Special Operations Forces. The FN SCAR family of firearms represents the highest levels of reliable function, consistent accuracy, comfortable ergonomics and the operating precision and safety expected from an FN firearm. Unique and simple in design, the rifle is very easy to maintain. With a reasonable amount of care, your FN SCAR 20S rifle should give you many years of dependable, enjoyable service. In order to take maximum advantage of the many features of your FN SCAR 20S rifle, regularly review this owner's manual.

Please contact FN Customer Support if you have any observations or questions regarding the performance or the operation of your rifle.

2. CONTENTS OF THE STORAGE CASE

The rifle and its accessories are supplied in a cardboard shipping container with foam insert. The contents of the container include:

- Rifle
- Design-fit foam insert that can be used in a typical mid length hard case
- One 10-round magazine
- Owner's manual
- Gun record book
- Locking device and two keys (use the locking device when storing and transporting the rifle; always keep keys in a safe place.)

3. SAFETY AND WARNINGS

⚠ DANGER

LIKE ALL FIREARMS, IF HANDLED IN A CARELESS OR RECKLESS MANNER, THIS RIFLE CAN BE VERY DANGEROUS. FAILURE TO FOLLOW THE INFORMATION IN THIS OWNER'S MANUAL COULD RESULT IN SERIOUS INJURY OR DEATH.

ALWAYS WEAR SAFETY GLASSES AND HEARING PROTECTION WHENEVER YOU ARE SHOOTING. ALWAYS MAKE CERTAIN THAT PERSONS CLOSE TO YOU ARE SIMILARLY PROTECTED. UNPROTECTED EYES MAY BE INJURED BY POWDER, GAS, CARBON RESIDUE, LUBRICANT, METALLIC PARTICLES, OR SIMILAR DEBRIS THAT MAY EMANATE OCCASIONALLY FROM ANY FIREARM IN NORMAL USE. WITHOUT ADEQUATE HEARING PROTECTION, EXPOSURE TO SHOOTING NOISE CAN PERMANENTLY DAMAGE YOUR HEARING.

For that reason, this firearm has been sold under the express understanding that FN America declines any responsibility and disclaim all liability claims for incidental or consequential damages, injuries, loss of use of property, commercial loss, loss of earnings and profits, resulting in whole or partly from:

- The use of reloaded ammunition
- A discharge with criminal intent or through negligence
- Improper or careless handling
- Unauthorized servicing
- The modification or alteration of the basic firearm design
- The use of unoriginal parts
- The modification or alteration of the safety devices
- The use of incorrect firearm and ammunition combinations
- The use of nonconforming or unsafe ammunition

- Inadequate care of the firearm (e.g., corrosion, damage.)
- Disregard of malfunctions
- Resale in contradiction to law
- Other circumstances beyond our direct and immediate control

***NOTICE!* FN AMERICA RESERVES THE RIGHT TO REFUSE SERVICING A FIREARM THAT HAS BEEN MODIFIED BY REMOVAL OF METAL FROM THE BARREL, MODIFICATIONS OF THE FIRING MECHANISM AND/OR OTHER PARTS, AND WILL, IN SUCH A CASE, ALWAYS RECOMMEND RESTORING THE FIREARM TO ITS ORIGINAL SPECIFICATIONS. PARTS AND LABOR REQUIRED FOR SUCH A RESTORATION ARE PAYABLE BY THE OWNER OF THE FIREARM.**

4. FIREARM SAFETY INFORMATION



FAILURE TO FOLLOW ANY OF THE FOLLOWING WARNINGS COULD RESULT IN SERIOUS INJURY OR DEATH.

As a firearm owner, you accept a set of demanding responsibilities. How seriously you take these responsibilities can be the difference between life and death.

There is no excuse for careless or abusive handling of any firearm. At all times handle this firearm and all other firearms with intense respect for their power and potential danger.

Please read and understand all of the cautions, warnings, notices, proper handling procedures and instructions outlined in this owner's manual before using your new firearm.

1. ALWAYS KEEP THE MUZZLE OF YOUR FIREARM POINTED IN A SAFE DIRECTION EVEN THOUGH YOU ARE CERTAIN IT IS UNLOADED.

Never point any firearm at anything you do not intend to shoot. Be extremely alert and aware of all persons and property within the range of your ammunition.

2. NEVER RELY TOTALLY ON YOUR FIREARM'S MECHANICAL SAFETY DEVICES. LIKE ANY MECHANICAL DEVICE, A SAFETY CAN SOMETIMES FAIL; IT CAN BE JARRED OR INADVERTENTLY MANIPULATED INTO AN UNSAFE CONDITION.

The word safety describes a firearm's trigger block mechanism, sear block mechanism, hammer block mechanism or firing pin block mechanism. Mechanical safeties are designed to place your firearm in a safer status, and no guarantee can be made that the firearm will not fire even if the safety is in the "on safe" position. Mechanical safeties merely aid safe gun handling and are no excuse for pointing your firearm's muzzle in an unsafe direction. See Section 9 for instructions on the operation of this firearm's safety.

Remember, safe gun handling does not stop with your firearm's mechanical safety devices, it starts there. Always treat this firearm with the respect due a loaded, ready-to-fire firearm.

Some firearms do not have a mechanical safety. Many target firearms, lever-action firearms and rifles do not have manual safety mechanisms. Therefore, it is critical to read and understand the owner's manual for every firearm which explains the safe operation of the firearm.

While it is a good idea to test your firearm's mechanical safety periodically for proper function, never test the safety while your firearm is loaded or pointed in an unsafe direction.

3. WHENEVER YOU HANDLE ANY FIREARM, OR HAND IT TO SOMEONE, ALWAYS OPEN THE ACTION IMMEDIATELY AND VISUALLY CHECK THE FIREARM'S CHAMBER AND MAGAZINE TO MAKE CERTAIN THAT THE FIREARM IS COMPLETELY UNLOADED.

Make certain the firearm does not inadvertently contain any ammunition. Always keep the chamber empty and the safety in the "on safe" position unless shooting is imminent.

If your firearm is equipped with a detachable magazine, be aware that removing the magazine does not mean your firearm is completely unloaded, a cartridge could be in the chamber. Always remove the magazine, open the action and visually inspect the chamber to make certain the firearm is completely unloaded.

4. ALWAYS WEAR EYE AND HEARING PROTECTION WHEN SHOOTING.

Unprotected, repeated exposure to gunfire can cause hearing damage. Wear ear protectors (shooting earplugs or muffs) to guard against such damage.

Wear shooting glasses to protect your eyes from flying particles. Allow proper distance (eye relief) between a scope and your eye when firing a

scoped rifle or shotgun. Do not use unorthodox shooting methods that could cause the rearward travel of the slide or bolt of a firearm to contact your eyes, face or hands. Always keep a safe distance between the muzzle of your firearm and any persons nearby, as muzzle blast, debris and ejecting shells could inflict serious injury.

Always wear eye protection when disassembling and cleaning your rifle to prevent the possibility of springs, spring-tensioned parts, solvents or other agents from contacting your eyes.

5. KEEP ALL FIREARMS UNLOADED DURING TRANSPORT, EVEN WHEN STORED IN A HOLSTER, GUN CASE, SCABBARD OR OTHER CONTAINER.

For law enforcement and military personnel, refer to the procedures of your department on carrying a loaded firearm.

6. DROPPING OR JARRING A LOADED FIREARM CAN CAUSE AN ACCIDENTAL DISCHARGE.

This can occur even with the safety in the “on safe” position or the hammer in the decocked position. Be extremely careful while hunting or during any shooting activity, to avoid dropping any firearm.

7. SHOOTING FROM ELEVATED SURFACES IS DANGEROUS.

Doing so may increase the risk of mishandling a firearm. The following rules should always be observed. Always make certain that the surface being used is safe and stable. Always make certain that your firearm is unloaded when it is being taken up and down from the surface. Always make certain that your firearm is not dropped from the surface or dropped while it is being taken up or down from the surface.

Remember, a loaded firearm may discharge when dropped, even with the safety in the “on safe” position.

8. STORE YOUR FIREARM AND AMMUNITION SEPARATELY, WELL BEYOND THE REACH OF CHILDREN.

Take prudent safeguards to ensure your firearm does not become available to untrained, inexperienced or unwelcome hands. Store all

firearms in secure, locked cases or a gun safe. Keep your firearm unloaded when not in use. At all times, comply with federal, state and local laws.

For law enforcement and military personnel, refer to the procedures of your department on storing your firearm.

9. BEWARE OF BARREL OBSTRUCTIONS.

Mud, snow and an infinite variety of other objects may inadvertently lodge in a barrel. It only takes a small obstruction to cause dangerously increased pressures that can damage your firearm and cause serious injury to yourself and others.

BEFORE CHECKING FOR A BARREL OBSTRUCTION, BE CERTAIN YOUR FIREARM IS COMPLETELY UNLOADED, THERE IS NOT A LIVE CARTRIDGE IN THE CHAMBER AND THE SAFETY IS IN THE “ON SAFE” POSITION.

Completely unload the firearm as described in Section 15. After assuring yourself that the firearm is completely unloaded, look through the barrel to be sure it is clear of obstructions. If an obstruction is seen, no matter how small it may be, clean the bore with a cleaning rod and patch as described in Sections 20 of this owner's manual.

10. BE ALERT TO THE SIGNS OF AMMUNITION MALFUNCTION. IF YOU DETECT AN OFF SOUND OR LIGHT RECOIL WHEN A CARTRIDGE IS FIRED, DO NOT LOAD ANOTHER CARTRIDGE INTO THE CHAMBER.

If your firearm fails to fire, keep the muzzle pointed in a safe direction for a minimum of 30 seconds. Carefully open the action and remove the cartridge from the chamber, and completely unload the firearm as described in Section 15. If the primer is indented, the defective cartridge should be disposed of in a way that cannot cause harm. If the primer is not indented, your firearm should be examined by the FN Service Center or a qualified gunsmith and the cause of the malfunction corrected before further use. Only *after* you have cleared

the cartridge from the chamber and completely unloaded the firearm, glance down the barrel to make sure that there are no obstructions in the barrel. If there is an obstruction, completely clear the barrel before loading and firing again. Failure to follow these instructions can cause extensive damage to your firearm and possible serious injury to yourself and others.

11. NEVER INSERT A CARTRIDGE OF THE INCORRECT CALIBER INTO ANY FIREARM.

The caliber of your firearm is marked on the barrel. Store all cartridges of different calibers in completely separate and well-marked containers. Never store cartridges of mixed calibers in a common container or in your pockets. See Section 11 for more information on the correct ammunition for your firearm.

12. EXAMINE EVERY CARTRIDGE YOU PUT IN YOUR FIREARM.

We assume no responsibility for the use of unsafe or improper firearm and ammunition combinations or damage or injury caused by damaged ammunition. It is your responsibility to read and heed all warnings in this owner's manual and on ammunition boxes. See Section 11 for more information on the correct ammunition for your firearm.

13. USE ONLY AMMUNITION MADE TO SAAMI (SPORTING ARMS AND AMMUNITION MANUFACTURERS' INSTITUTE) OR NATO STANDARDS. DO NOT USE HANDLOADED, RELOADED OR STEEL-CASED AMMUNITION.

The barrel and action of this rifle have been made with substantial safety margins over the pressures developed by established U.S. commercial loads. Nevertheless, we can assume no liability for incidents that occur using cartridges of nonstandard dimensions or that develop pressures in excess of the standards established by SAAMI or the North Atlantic Treaty Organization (NATO).

14. MAKE SURE OF ADEQUATE VENTILATION IN THE AREA THAT YOU DISCHARGE A FIREARM. LEAD EXPOSURE CAN OCCUR

FROM DISCHARGING FIREARMS IN POORLY VENTILATED AREAS, CLEANING FIREARMS OR HANDLING AMMUNITION.

Lead is a substance that has been known to cause birth defects, reproductive harm and other serious injury. Wash hands thoroughly after exposure to ammunition or after cleaning a firearm.

15. DO NOT SNAP THE FIRING PIN ON AN EMPTY CHAMBER: THE CHAMBER MAY NOT BE EMPTY!

While dry firing will not harm the rifle, doing so risks an accidental discharge. Treat every firearm with the respect due to a loaded firearm, even though you are certain the firearm is unloaded. ***Before dry firing any firearm, ensure it has been completely cleared: the magazine removed, chamber inspected for the presence of any ammunition. Keep the firearm pointed in a safe direction while dry firing.***

16. KEEP YOUR FINGERS AWAY FROM THE TRIGGER AT ALL TIMES UNTIL SHOOTING IS IMMINENT.

17. BE SURE OF YOUR TARGET AND BACKSTOP, PARTICULARLY DURING LOW LIGHT PERIODS.

Know the range of your ammunition. Never shoot at water or hard objects.

18. ALWAYS UNLOAD YOUR FIREARM'S CHAMBER BEFORE CROSSING A FENCE, CLIMBING A TREE, JUMPING A DITCH OR NEGOTIATING OTHER OBSTACLES.

Never place your firearm on or against a fence, tree, car or other similar object.

For law enforcement and military personnel, refer to the procedures of your department.

19. BE DEFENSIVE AND ON GUARD AGAINST UNSAFE GUN HANDLING AROUND YOU AND OTHERS.

Don't be timid when it comes to gun safety. If you observe other shooters violating any of these safety precautions, politely suggest safer handling practices.

20. BE CERTAIN YOUR FIREARM IS UNLOADED BEFORE CLEANING.

Because so many gun accidents occur when a firearm is being cleaned, special and extreme care should be taken to be sure your firearm is unloaded before disassembly, cleaning and reassembly. Keep ammunition away from the cleaning location. Never test the mechanical function of any firearm with live ammunition.

21. TEACH AND SUPERVISE FIREARMS SAFETY TO ALL MEMBERS OF YOUR FAMILY, ESPECIALLY TO CHILDREN AND NON-SHOOTERS.

Closely supervise newcomers to the shooting sports. Encourage enrollment in hunting and shooting safety courses.

22. NEVER DRINK ALCOHOLIC BEVERAGES OR TAKE ANY TYPE OF REFLEX/JUDGEMENT IMPAIRING MEDICATION OR DRUGS BEFORE OR DURING SHOOTING.

Your vision, motor skills and judgment could be dangerously impaired, making your gun handling unsafe to you and to others. Consult your physician for personalized medical advice.

23. READ AND HEED ALL WARNINGS IN THIS OWNER'S MANUAL, ON AMMUNITION BOXES AND WITH ALL ACCESSORIES THAT YOU INSTALL ON YOUR FIREARM.

It is your responsibility to secure the most up-to-date information on the safe handling procedures for your FN firearm. We assume no liability for incidents that occur when unsafe or improper rifle accessories or ammunition combinations are used.

24. PRACTICE PERIODIC MAINTENANCE, AVOID UNAUTHORIZED SERVICING.

Your firearm is a mechanical device, and as such, is subject to wear and requires periodic inspection, adjustment and service. Refer to Section 22. FN firearms should be serviced by the FN Service Center.

We cannot and do not assume any responsibility for injuries suffered or

caused by unauthorized servicing, alterations or modifications of FN firearms.

25. WE RESERVE THE RIGHT TO REFUSE SERVICE ON FIREARMS THAT HAVE BEEN ALTERED, ADDED TO OR SUBSTANTIALLY CHANGED.

Removal of metal from the barrel or modifications of the firing mechanism and/or operating parts may lead to a refusal of service on such firearms. We will charge the owner for parts and labor to return the firearm to original FN specifications.

DO NOT, UNDER ANY CIRCUMSTANCES, ALTER THE TRIGGER, SAFETY OR OTHER PARTS OF THE FIRING MECHANISM OF THIS OR ANY OTHER FIREARM. FAILURE TO OBEY THIS WARNING MAY RESULT IN INJURY OR DEATH TO YOURSELF OR OTHERS.

BE CAREFUL!

5. DESCRIPTION AND OPERATION

FIGURE 1

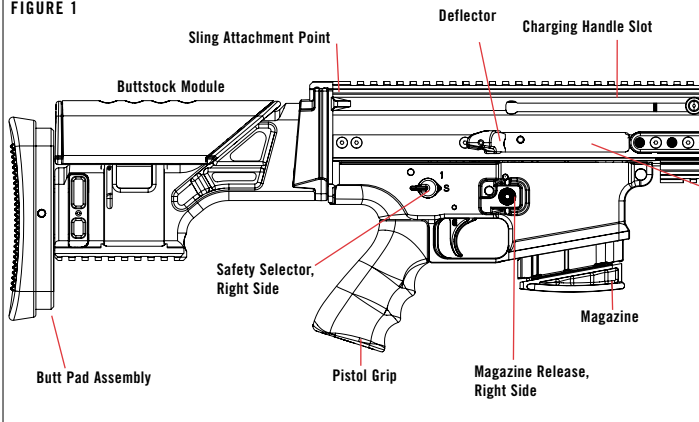
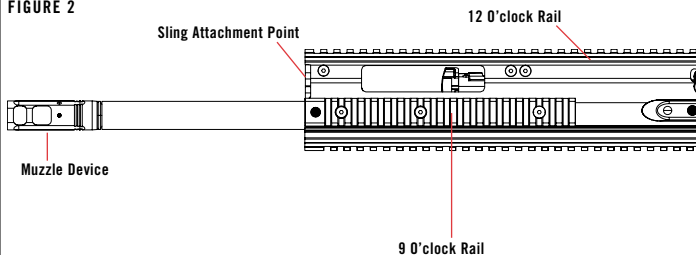
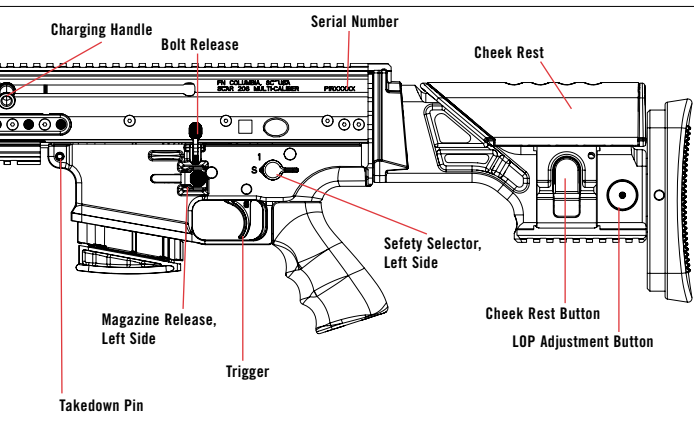
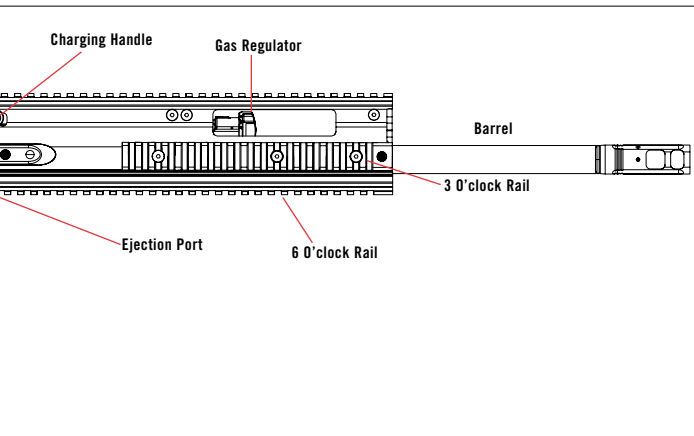

FIGURE 2





5.1 DESCRIPTION

The FN SCAR 20S is a gas-operated, semi-automatic repeating rifle. FN SCAR rifles are a direct result of the U.S. military's search for a modular battle rifle that is easy to use and extremely reliable. FN SCAR rifles have been developed using the latest design and manufacturing techniques, extensive materials testing, real-world research and end user assessments from special operations forces operators. This information has culminated in the next generation of technologically advanced rifles. To make the transition to the FN SCAR rifles easier, the ergonomically designed pistol grip stock is designed with dimensions to suit operators familiar with the M16/M4 platform.

All FN SCAR rifles and carbines now feature an ambidextrous non-reciprocating charging handle assembly making the FN SCAR series even more user-friendly and adaptive. You may use one or both charging handles in your rifle and they can be placed on either side based on user preference.

Refer to Section 21 Assembly for more information.

While like the FN SCAR 17S in many ways, the FN SCAR 20S is a commercial version of the battle-proven FN MK 20 SSR. It has a longer, heavier barrel for increased precision and range. The trigger is improved and lightened for increased trigger control. The buttstock module is more adjustable and better suited for prone shooting positions. The receiver is lengthened to increase stability and provide longer mounting surfaces for precision rifle optics and other optical devices.

5.2 OPERATION

When the trigger is pulled, the firing pin strikes the primer of the cartridge, resulting in the rifle firing. Gases from the fired cartridge travel down the barrel with some diverted into the gas regulator. The gases impart energy onto the short stroke gas piston, pushing it to the rear. The gas piston contacts the front of the bolt carrier moving it to the rear. During the rearward movement of the bolt, the empty cartridge case is ejected out of the ejection port. If there is a cartridge in the magazine, the bolt then returns forward by the force of the recoil spring, picks up a cartridge from

the magazine and loads it into the chamber, ready to be fired. If there is not a cartridge in the magazine during this movement, the bolt release/lock engages, and the bolt remains locked in the rearmost, open position.

With cartridges in the magazine and chamber, and the safety selector in the “off safe” position, the rifle will fire a single round with each successive pull of the trigger until the magazine and chamber are empty. When the last round has been fired, the bolt will lock in the rearmost, open position. This allows for fast, convenient reloading.

6. NOMENCLATURE

In conventional firearm terminology, the position and movement of parts are described as they occur with the firearm horizontal and in normal firing position; i.e., the muzzle is forward or in front; the buttstock is rearward or to the rear; the trigger is downward or underneath; the sight is upward or on top. For general parts nomenclature, refer to Figures 1 and 2.

7. SERIAL NUMBER

The serial number is located on the left side of the receiver at the rear, just below the upper rail. Record the serial number at the front of this owner’s manual for future reference.

8. INITIAL CLEANING



WEAR EYE PROTECTION WHEN ASSEMBLING AND DISASSEMBLING YOUR RIFLE TO PREVENT SPRINGS, SPRING-LOADED PARTS, SOLVENTS OR OTHER AGENTS FROM CONTACTING YOUR EYES, RESULTING IN INJURY.

Various exposed metal parts of this rifle have been coated at the factory with a rust preventative compound. Before using the rifle, clean the anti-rust compound from the inside of the barrel, receiver, bolt and the action/chamber areas with military-grade cleaner/lubricant as explained in Section 20.1.

If your rifle is to be stored, it is acceptable to leave the rust preventative compound on the rifle and keep it in its original packaging. Never fire the rifle upon purchase without cleaning it first. If the rifle contains hardened grease or other substances that you cannot remove, have the rifle checked by your dealer or departmental armorer. For law enforcement and military personnel, refer to the procedures of your department.

9. OPERATION OF THE SAFETY SELECTOR

▲WARNING

ALWAYS KEEP THE SAFETY SELECTOR IN THE “ON SAFE” POSITION UNLESS SHOOTING IS IMMINENT. ALWAYS KEEP THE MUZZLE POINTED IN A SAFE DIRECTION. FAILURE TO FOLLOW THESE WARNINGS COULD RESULT IN SERIOUS INJURY OR DEATH.

FN SCAR rifles utilize an ambidextrous safety selector located on the trigger module just rearward and above the trigger. This location allows the safety selector to be easily manipulated with the thumb of the firing hand.

With the safety selector in the “S” position, the rifle is in the “on safe” position, and rearward movement of the trigger is completely blocked (Figure 3).

With the safety selector in the “1” position the rifle is “off safe” and ready to fire (Figure 4).

FIGURE 3

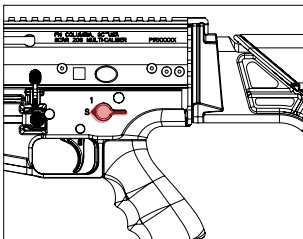

Safety shown in the “on-safe” position.

FIGURE 4

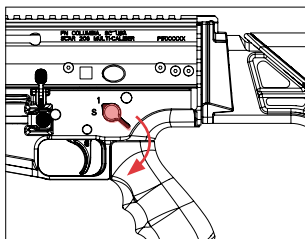

Safety selector in the “fire” or “1” position.

10. BOLT RELEASE

⚠ WARNING

WHEN USING THE BOLT RELEASE ALWAYS KEEP THE MUZZLE POINTED IN A SAFE DIRECTION AND KEEP YOUR FINGERS AWAY FROM THE TRIGGER. UNLESS SHOOTING IS IMMINENT, ALWAYS REMOVE THE MAGAZINE FROM THE RIFLE BEFORE CLOSING THE BOLT TO PREVENT INADVERTENTLY LOADING A CARTRIDGE FROM THE MAGAZINE INTO THE CHAMBER.

MAKE SURE YOUR FINGERS ARE SAFELY AWAY FROM THE EJECTION PORT AT ALL TIMES WHEN THE BOLT IS LOCKED OPEN AND WHEN THE BOLT IS RELEASED TO AVOID PINCHING THEM WHEN THE BOLT CLOSSES.

FAILURE TO FOLLOW THESE WARNINGS COULD RESULT IN SERIOUS INJURY OR DEATH.

10.1 BOLT RELEASE FUNCTION

The bolt release is located on the left side of the rifle, just above the magazine release (Figure 5). It automatically engages after the last cartridge in the magazine has been fired and locks the bolt to the rearmost, open position.

To release the bolt when no magazine is in the rifle and the bolt is locked rearward, press inward on the top of the bolt release, or pull the charging handle to the rear to disengage the bolt release and then release the charging handle. This will allow the bolt to return to the forward position.

FIGURE 5

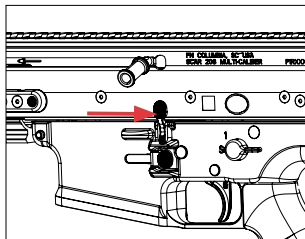

Location of the bolt release.

10.2 BOLT LOCK FUNCTION

The bolt release can also be used to lock the bolt in the rearward position when the magazine is removed. To lock the bolt in the open or rear position, pull the charging handle all the way to the rear and press inward on the bottom portion of the bolt release (Figure 6).

FIGURE 6

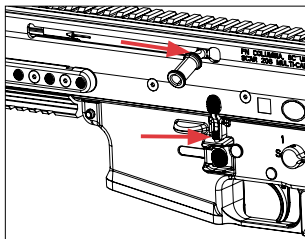

Using the bolt release as a bolt lock.

11. AMMUNITION

⚠ WARNING

DO NOT USE AMMUNITION OTHER THAN WHAT IS DESIGNED FOR USE IN YOUR FN SCAR RIFLE. EXAMINE EVERY CARTRIDGE YOU PUT IN YOUR FIREARM.

DISCHARGING FIREARMS IN POORLY VENTILATED AREAS, CLEANING FIREARMS OR HANDLING AMMUNITION MAY RESULT IN EXPOSURE TO LEAD AND OTHER SUBSTANCES KNOWN TO CAUSE BIRTH DEFECTS, REPRODUCTIVE HARM AND OTHER SERIOUS PHYSICAL INJURY. HAVE ADEQUATE VENTILATION AT ALL TIMES. WASH HANDS THOROUGHLY AFTER HANDLING AMMUNITION.

The barrel and action of this rifle have been made with substantial safety margins over the pressures developed by established American loads. However, we assume no responsibility for incidents that occur using cartridges of nonstandard dimension or those developing pressures in excess of NATO or SAAMI (Sporting Arms and Ammunition Manufacturers' Institute) established standards.

To verify the caliber/cartridge your FN SCAR 20S is chambered in, refer to the caliber marking located on the left side of the barrel just behind the muzzle device. See Figure 7. Only use factory-made ammunition that matches this description.

FIGURE 7

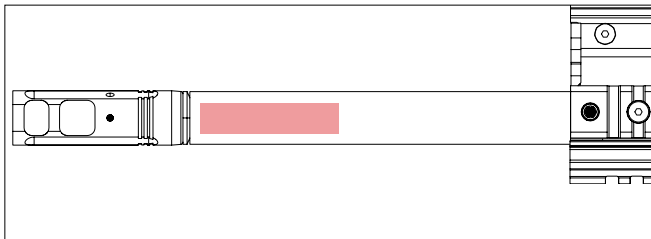

Location for caliber markings on barrel.

12. MAGAZINE CAPACITY

The FN SCAR 20S magazines are the same as the FN SCAR 17S magazines but unique to these rifles and should not be used in other rifles. No other magazine type should be used in your FN SCAR rifle. The specialized designs make the magazine highly reliable and result in easy maintenance and cleaning.

FN SCAR 20S rifles have a standard magazine capacity of 10 cartridges. FN SCAR 17S magazines with a capacity of 20 cartridges will fit the FN SCAR 20S. However, some jurisdictions limit the magazine capacity to 10 cartridges. All FN SCAR rifles sold in those jurisdictions will be shipped with limited capacity magazines in compliance with local or state law. Make sure you have verified the capacity of your magazine before loading it in your rifle.

13. LOADING

⚠ WARNING

WHEN LOADING YOUR RIFLE ALWAYS KEEP THE MUZZLE POINTED IN A SAFE DIRECTION, ALWAYS PLACE THE SAFETY SELECTOR IN THE “ON SAFE” POSITION AND KEEP YOUR FINGERS AWAY FROM THE TRIGGER. FAILURE TO FOLLOW THESE WARNINGS COULD RESULT IN SERIOUS INJURY OR DEATH.

DO NOT CARRY YOUR RIFLE WITH A CARTRIDGE IN THE CHAMBER TO AVOID ACCIDENTAL DISCHARGE. WHEN FIRING IS NO LONGER IMMINENT, PLACE THE SAFETY SELECTOR IN THE “ON SAFE” POSITION, REMOVE THE MAGAZINE AND UNLOAD THE CHAMBER AS EXPLAINED IN SECTION 15.1. FAILURE TO FOLLOW THESE WARNINGS COULD RESULT IN SERIOUS INJURY OR DEATH.

13.1 FILLING THE MAGAZINE

▲WARNING

DO NOT INSERT THE MAGAZINE INTO THE RIFLE, NOR LOAD A CARTRIDGE INTO THE CHAMBER, UNLESS SHOOTING IS IMMINENT.

1. Make sure the safety selector is in the “on safe” position as explained in Section 9 and the muzzle is pointed in a safe direction.
2. Press the ambidextrous magazine release located just in front of the trigger guard. The right magazine release is shown in Figure 8, the left magazine release is shown in Figure 9. Remove the magazine with your free hand.
3. Pull the bolt completely rearward, lock the bolt in the open position as explained in Section 10.2 and inspect the chamber to make sure it is empty. Return the bolt to the forward, closed position.
4. Load the cartridges into the magazine by placing a cartridge on the top of the retaining lips and, with your thumb, pushing it straight down against the force of the follower spring until it locks into position under the retaining lips (Figure 10).

Continue to fill the magazine in this manner. Care should be exercised in positioning each cartridge so that its base is flush with the rear of the magazine. If the nose of a cartridge protrudes beyond the front of the magazine, it could cause feeding problems or interfere with the insertion of the magazine into the rifle.

FIGURE 8

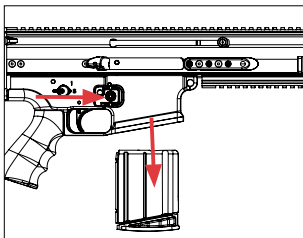

Remove the magazine by pushing on the ambidextrous magazine release (right side).

FIGURE 9

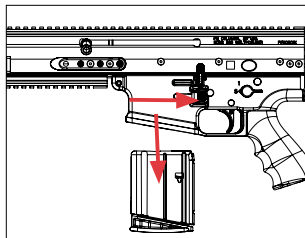

Remove the magazine by pushing on the ambidextrous magazine release (left side).

FIGURE 10

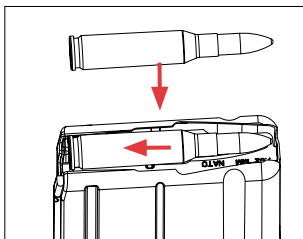

Press each cartridge straight down into the magazine and to the rear.

13.2. LOADING THE CHAMBER FROM THE MAGAZINE

▲WARNING

WHEN LOADING YOUR RIFLE ALWAYS KEEP THE MUZZLE POINTED IN A SAFE DIRECTION AND PLACE THE SAFETY SELECTOR IN THE “ON SAFE” POSITION. KEEP YOUR FINGERS AWAY FROM THE TRIGGER. FAILURE TO FOLLOW THESE WARNINGS COULD RESULT IN SERIOUS INJURY OR DEATH.

1. Make sure the safety selector is in the “on safe” position as explained in Section 9 and the muzzle is pointed in a safe direction.

2. Lock the bolt in the open or rear position by pulling the charging handle all the way to the rear and pressing inward on the bottom portion of the bolt release (Figure 6, page 20).
3. Insert the loaded magazine into the magazine well until it locks in place.
4. If shooting is imminent, a cartridge can now be moved from the magazine to the chamber by pulling back fully on the charging handle and releasing it, or pressing on the top of the bolt release, and allowing the bolt to move forward into battery. If the bolt is not allowed to close in this manner, there is a possibility that it will not close completely, preventing the rifle from firing.
5. Push forward on the charging handle, using it as a forward assist to ensure the bolt is locked and the round is properly chambered.

▲WARNING

THE RIFLE IS NOW READY TO FIRE BY MOVING THE SAFETY SELECTOR TO THE “OFF SAFE” POSITION AND PULLING THE TRIGGER.

14. FIRING

▲WARNING

NEVER CHAMBER A CARTRIDGE OR MOVE THE SAFETY SELECTOR FROM THE “ON SAFE” POSITION UNLESS SHOOTING IS IMMINENT. ALWAYS KEEP THE MUZZLE POINTED IN A SAFE DIRECTION. FAILURE TO FOLLOW THESE WARNINGS COULD RESULT IN SERIOUS INJURY OR DEATH.

14.1 FIRING PROCEDURES

1. Make sure the safety selector is in the “on safe” position as explained in Section 9 and the muzzle is pointed in a safe direction.

2. Load a cartridge into the chamber as explained previously. With a cartridge in the chamber, you need only to move the safety selector to the “off safe” position to make the rifle ready for firing. Do not move the safety selector to the “off safe” position unless shooting is imminent.

▲WARNING

THE RIFLE IS NOW READY TO FIRE BY MOVING THE SAFETY SELECTOR TO THE OFF SAFE POSITION AND PULLING THE TRIGGER.

3. When ready to fire, move the safety selector into the “off safe” position, take aim and squeeze the trigger.

▲WARNING

DURING EXTENDED SHOOTING SESSIONS OR RAPID FIRING, THE 3, 6 AND 9 O’CLOCK ACCESSORY RAILS CAN BECOME EXTREMELY HOT. WEAR GLOVES TO PREVENT BURNING YOUR HANDS. FAILURE TO FOLLOW THIS WARNING COULD RESULT IN SERIOUS INJURY.

4. After a cartridge has fired, the bolt and bolt carrier automatically move rearward, eject the empty case, then return forward, chambering a loaded cartridge from the magazine. Because fired cases are ejected to the right side, bystanders should not stand to the right of the shooter.

NOTICE! THE CHARGING HANDLES ON FN SCAR RIFLES EQUIPPED WITH NON-RECIPROCATING CHARGING HANDLE (NRCH) WILL NOT MOVE AS THE RIFLE CYCLES, LIKE ON EARLIER FN SCAR RIFLES.

5. This operation is repeated each time you pull the trigger until the last cartridge from the magazine has been fired. If shooting is no longer imminent, immediately place the safety selector in the “on safe” position. See “Unloading” in Section 15 for more information.
6. After the last cartridge is fired, the bolt will lock in the rearward position. If you wish to continue shooting, you can reload the rifle by removing the empty magazine and inserting a loaded magazine as

described previously. After reloading the magazine, if shooting is imminent, you can chamber a cartridge and resume firing by pulling the charging handle fully rearward and releasing it, or by pressing the bolt release (Figure 5, page 19) and pushing forward on the charging handle, using it as a forward assist to ensure the bolt is locked and the round is properly chambered.

If your rifle is to be put away and stored, do not reload the rifle or magazine. The chamber and magazine must remain empty when storing your rifle.

▲WARNING

AFTER FIRING, OR WHEN SHOOTING IS NO LONGER IMMINENT, IMMEDIATELY PLACE THE SAFETY SELECTOR IN THE “ON SAFE” POSITION. FAILURE TO FOLLOW THESE WARNINGS COULD RESULT IN SERIOUS INJURY OR DEATH.

EVEN WITH THE BOLT OPEN AFTER SHOOTING, DO NOT ASSUME THE RIFLE IS UNLOADED. ALWAYS INSPECT THE CHAMBER, BARREL, FEED MECHANISM AND MAGAZINE TO BE CERTAIN THE RIFLE IS COMPLETELY UNLOADED. FAILURE TO FOLLOW THESE WARNINGS COULD RESULT IN SERIOUS INJURY OR DEATH.

14.2 ADJUSTING THE GAS REGULATOR

The gas regulator and piston on the FN SCAR® are designed to keep excess carbon from accumulating on the bolt carrier assembly. Most of the carbon buildup is blown out of the vent hole in the front of the regulator. It is recommended that the gas regulator be cycled 2-3 times prior to placing it on the required setting. This will ensure the gas regulator is on the right setting and that it continues to move freely. Positions of the gas regulator as viewed from the muzzle end:

1. 12 o'clock setting - For standard operations (Figure 11).
2. 10 o'clock setting - Suppressed operations. Does not guarantee safe and reliable operation with all suppressors (Figure 12).

3. 4 o'clock setting - Disassembly, cleaning, and reassembly (Figure 13).

FIGURE 11

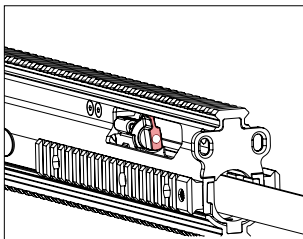

Gas regulator in the standard position.
(12 o'clock).

FIGURE 12

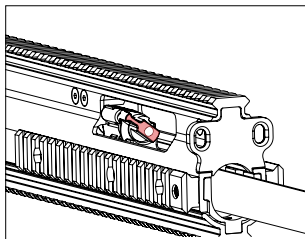

Gas regulator in the suppressed position.
(10 o'clock).

FIGURE 13

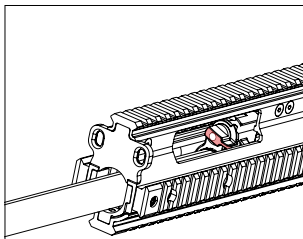

Gas regulator in the disassembly position.
(4 o'clock).

▲WARNING

THE INSTALLATION OF A SOUND SUPPRESSOR (SILENCER) ON A FIREARM WILL AFFECT THE OPERATING CHARACTERISTICS OF THAT FIREARM, MAY INTERFERE WITH THE SAFE AND RELIABLE OPERATION OF THE FIREARM AND COULD RESULT IN FIREARM DAMAGE, PERSONAL INJURY OR DEATH. THE ACTUAL EFFECT ON THE FIREARM IS DEPENDENT ON THE COMBINATION OF FIREARM

DESIGN, SUPPRESSOR DESIGN, AND AMMUNITION TYPE USED. THE USE OF A SUPPRESSOR ON YOUR FN FIREARM INTRODUCES VARIABLES OUTSIDE OF FN'S CONTROL. FN CANNOT ACCOUNT FOR EVERY POSSIBLE SUPPRESSOR AND AMMUNITION COMBINATION THAT MIGHT OCCUR IN CONJUNCTION WITH THE FIREARM. THEREFORE, ANY AND ALL USE OF A SUPPRESSOR WITH YOUR FN FIREARM IS AT YOUR RISK AND VOIDS THE WARRANTY.

14.3 MALFUNCTIONS

If your rifle suffers a malfunction, such as the failure to fully eject a fired cartridge case, perform the following operation to clear the rifle.

1. Immediately place the safety selector in the “on safe” position as explained in Section 9 and keep the muzzle pointed in a safe direction.
2. Remove the magazine from the rifle as explained in Section 13.1.
3. Pull rearward on the charging handle to completely eject the cartridge case.
4. Inspect and ensure the gas regulator is in the correct position as explained in Section 14.2, and if necessary, clean the rifle as outlined in Section 20.

15. UNLOADING



WHEN UNLOADING YOUR RIFLE ALWAYS PLACE THE SAFETY SELECTOR IN THE “ON SAFE” POSITION AND REMOVE THE MAGAZINE. KEEP THE MUZZLE POINTED IN A SAFE DIRECTION AND YOUR FINGERS AWAY FROM THE TRIGGER. LOCK THE BOLT IN THE OPEN POSITION AS EXPLAINED IN SECTION 10.2. INSPECT THE CHAMBER AND BARREL CAREFULLY TO BE SURE ALL LIVE

CARTRIDGES ARE CLEARED FROM THE FIREARM. FAILURE TO FOLLOW THESE WARNINGS COULD RESULT IN SERIOUS INJURY OR DEATH.

15.1 UNLOADING THE RIFLE

1. Make sure the safety selector is in the “on safe” position as explained in Section 9 and the muzzle is pointed in a safe direction.
2. Press the ambidextrous magazine release and remove the magazine.
3. Extract and eject any live cartridge that may be in the chamber by pulling rearward on the charging handle to draw the bolt to its rearmost, open position and pressing the bolt lock as explained in Section 10.2. Please note that the bolt will not automatically lock in the rearward position when the magazine is removed or when a loaded magazine is present. As a good safety practice, hold the bolt open and visually inspect the chamber to be certain a live cartridge is not present (Figure 14).

FIGURE 14

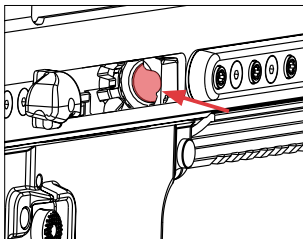

Verify the chamber is empty.

4. With the magazine removed and the chamber empty, close the bolt. Make certain the safety selector is in the “on safe” position and properly store your rifle.

15.2 UNLOADING THE MAGAZINE

Unload the magazine by manually pushing the cartridges, one at a time, forward and out of the magazine.

16. BUTTSTOCK MODULE

▲WARNING

BEFORE PERFORMING STOCK ADJUSTMENT PROCEDURES, PLACE THE SAFETY SELECTOR IN THE “ON SAFE” POSITION. REMOVE THE MAGAZINE, LOCK OPEN THE BOLT AS EXPLAINED IN SECTION 10.2 AND MAKE CERTAIN THE CHAMBER IS COMPLETELY UNLOADED. KEEP THE MUZZLE POINTED IN A SAFE DIRECTION. FAILURE TO FOLLOW THESE WARNINGS COULD RESULT IN SERIOUS INJURY OR DEATH.

The FN SCAR 20S buttstock module has been designed for precision shooting typically done in the prone position. It is adjustable for length of pull (LOP) and cheek rest height to fit the size of the operator in different positions with their specific optics.

16.1 ADJUSTING THE BUTTSTOCK FOR LENGTH OF PULL (LOP)

1. To adjust the length of pull (LOP), press the LOP adjustment lock (Figure 15) and push or pull butt pad assembly to change LOP as desired (Figure 16). Each increment of adjustment is equal to approximately .25" (5mm) for a total of 1.75" (45mm) of LOP adjustment. After adjusting LOP, check to see that the LOP adjustment lock is fully engaged by pushing in on the rear of the stock.

FIGURE 15

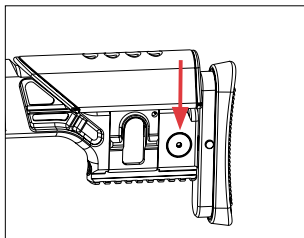

Press and hold the LOP adjustment button.

FIGURE 16

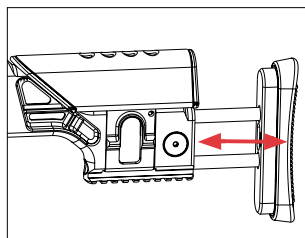

Move butt pad assembly to the desired length.

16.2 ADJUSTING THE CHEEK REST HEIGHT

To adjust the cheek rest height, press the cheek rest button (Figure 17) and push or pull the cheek rest up or down to the desired position (Figure 18). Raising the cheek rest will provide an additional 1.1" (28mm) of comb height. After adjusting the cheek rest to the desired setting, check to see that the cheek rest lock is fully engaged by pushing down on the cheek rest.

FIGURE 17

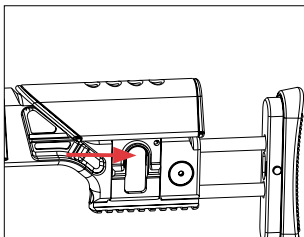

Press and hold the cheek rest button.

FIGURE 18

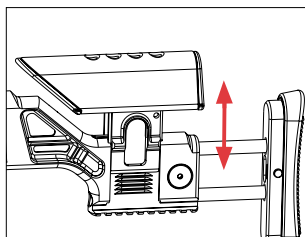

Move the cheek to the desired height.

17. MOUNTING OPTICS AND SIGHTS

⚠WARNING

BEFORE MOUNTING AND ADJUSTING OPTICAL OR IRON SIGHTS, PLACE THE SAFETY SELECTOR IN THE “ON SAFE” POSITION. REMOVE THE MAGAZINE, LOCK OPEN THE BOLT AS EXPLAINED IN SECTION 10.2 AND MAKE CERTAIN THE CHAMBER IS COMPLETELY UNLOADED. KEEP THE MUZZLE POINTED IN A SAFE DIRECTION. FAILURE TO FOLLOW THESE WARNINGS COULD RESULT IN SERIOUS INJURY OR DEATH.

The FN SCAR 20S receiver is machined with a MIL-STD 1913 rail for optics mounting on top. Because the specific sight used is based on specific user preference, FN does not include an optical sight with the FN SCAR 20S. Many scopes and scope mounts are commercially available. The 12 o'clock MIL-STD 1913 rail slots are numbered for recording the location of sights and optics for future reference, if removed. Iron sights may also be mounted, if desired.

Consult your dealer or a qualified gunsmith for mounting optical or iron sights that are commercially available. Ensure that once mounted they do not interfere with the normal operation of the rifle.

Follow your optic's instructions for mounting and ensure there is enough clearance between the ocular lens of the scope and your eye and face.

18. MOUNTING ACCESSORIES

⚠WARNING

BEFORE MOUNTING A SCOPE, SIGHTS OR OTHER ACCESSORIES ON YOUR RIFLE, PLACE THE SAFETY SELECTOR IN THE “ON SAFE” POSITION. REMOVE THE MAGAZINE, LOCK OPEN THE BOLT AS EXPLAINED IN SECTION 10.2 AND MAKE CERTAIN THE CHAMBER IS COMPLETELY UNLOADED. KEEP THE MUZZLE POINTED IN A SAFE DIRECTION. FAILURE TO FOLLOW THESE WARNINGS COULD RESULT IN SERIOUS INJURY OR DEATH.

The FN SCAR receiver is machined with a MIL-STD 1913 rail for optics mounting on top, along with three accessory MIL-STD 1913 rails in the fore-end area positioned at 3, 6 and 9 o'clock. Take care when mounting optics or other accessories so that they do not interfere with the normal operation of the rifle. Follow your accessory's instructions for mounting and ensure there is enough clearance between the accessory and the rifle to avoid malfunctions.

19. DISASSEMBLY

▲WARNING

BEFORE PERFORMING DISASSEMBLY PROCEDURES, PLACE THE SAFETY SELECTOR IN THE "ON SAFE" POSITION. REMOVE THE MAGAZINE, LOCK OPEN THE BOLT AS EXPLAINED IN SECTION 10.2 AND MAKE CERTAIN THE CHAMBER IS COMPLETELY UNLOADED. KEEP THE MUZZLE POINTED IN A SAFE DIRECTION. FAILURE TO FOLLOW THESE WARNINGS COULD RESULT IN SERIOUS INJURY OR DEATH.

WEAR EYE PROTECTION WHEN DISASSEMBLING AND CLEANING YOUR RIFLE TO PREVENT SPRINGS, SPRING-LOADED PARTS, SOLVENTS OR OTHER AGENTS FROM CONTACTING YOUR EYES, RESULTING IN INJURY.

***NOTICE!* THIS RIFLE IS A SPECIALIZED, FINELY FITTED MECHANISM. YOU MAY DAMAGE IT BEYOND REPAIR OR LOSE SMALL PARTS BY ATTEMPTING TO DISASSEMBLE THE INNER MECHANISM ASSEMBLIES. IF FURTHER DISASSEMBLY FOR SERVICE OR CLEANING IS REQUIRED, PLEASE SEND IT TO THE FN SERVICE CENTER LOCATED IN COLUMBIA, SOUTH CAROLINA.**

***NOTICE!* THE FOLLOWING DISASSEMBLY PROCEDURES ARE DESIGNED TO BE PERFORMED WITH FINGER PRESSURE ONLY AND NO TOOLS ARE TO BE USED. IF YOU CANNOT COMPLETE THE DISASSEMBLY PROCEDURES DESCRIBED WITHOUT THE USE OF TOOLS, STOP AND CONTACT FN SERVICE CENTER IN COLUMBIA, SOUTH CAROLINA.**

19.1 REMOVAL OF THE TRIGGER MODULE

1. Remove the magazine and make certain the rifle is completely unloaded and the safety selector is in the “on safe” position as explained in Section 9. Make sure the bolt is forward on an empty chamber as explained in Section 10.
2. Push in on the takedown pin from the left side (Figure 19) and pull it out to the right until it stops (Figure 20).

IMPORTANT: The takedown pin is captive and cannot be removed completely from the trigger module.

FIGURE 19

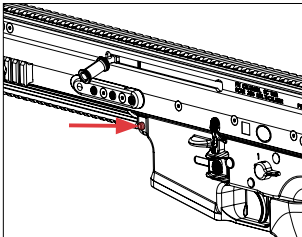

Push on the take down pin from the left side.

FIGURE 20

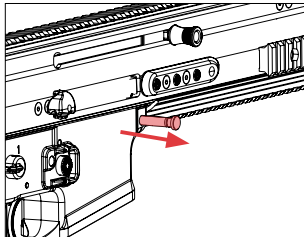

Pull the take down pin to the right until it stops.

FIGURE 21

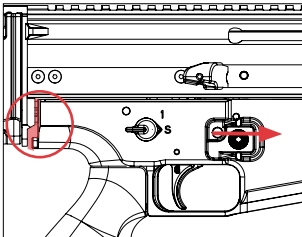

Push the trigger module forward.

FIGURE 22

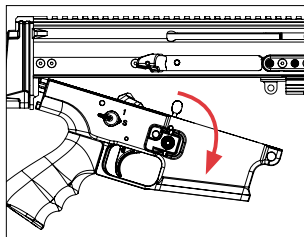

Rotate the trigger module down to remove it.

3. Push the trigger module forward, releasing it from the backplate (Figure 21).
4. Pull down to remove the trigger module from the receiver (Figure 22).

19.2 REMOVAL OF THE BUTTSTOCK MODULE

1. Remove the magazine and make certain the rifle is completely unloaded and the safety selector is in the on safe position as explained in Section 9.
2. Remove the trigger module as explained in Section 19.1.
3. Push the buttstock module downward and off of the receiver assembly backplate (Figure 23).

FIGURE 23

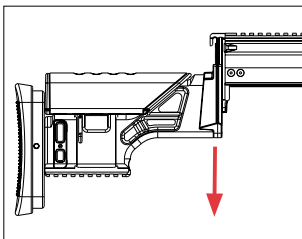

Push the buttstock module off the receiver assembly.

19.3 REMOVAL OF THE MOVING PARTS ASSEMBLY

1. Remove the magazine and make certain the rifle is completely unloaded and the safety selector is in the “on safe” position as explained in Section 9.
2. Remove the trigger module as explained in Section 19.1 and the Buttstock Module as explained in Section 19.2.

3. Remove drive spring/guide rod assembly by pushing it out of the rear of the receiver. (Figure 24)
4. While leaving the charging handle fully forward, reach inside of the receiver and slide the bolt carrier out of the rear of the receiver (Figure 25).

FIGURE 24

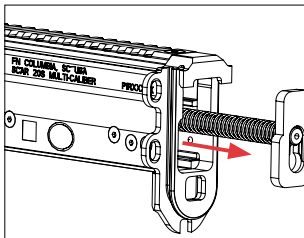

Remove drive spring/guide rod assembly.

FIGURE 25

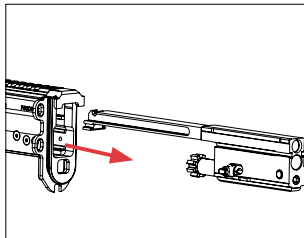

Slide bolt carrier out of the rear of the receiver.

Alternately, you may hold the charging handle in the forward, locked position, the entire bolt carrier can be removed from the rear of the receiver by placing your hand at the rear of the receiver and raising the muzzle, allowing the bolt carrier to slide out into your hand.

5. Pull the charging handles rearward until they align with the rear most opening in the charging handle slots. Then remove both charging handles by pulling them out (Figure 26).
6. Reaching inside the receiver, slide the charging sled out of the rear of the receiver (Figure 27). Do not disassemble the charging sled beyond this point.

FIGURE 26

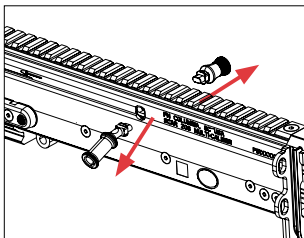

Remove charging handles.

FIGURE 27

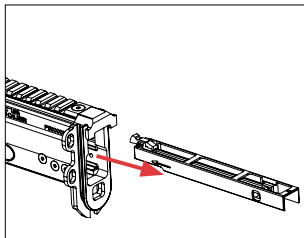

Slide charging sled out of the rear of the receiver.

19.4 DISASSEMBLY OF THE MOVING PARTS ASSEMBLY

1. Remove the magazine and make certain the rifle is completely unloaded and the safety selector is in the “on safe” position as explained in Section 9.
2. Remove the trigger module as explained in Section 19.1.
3. Remove the buttstock module as explained in Section 19.2.
4. Remove moving parts assembly as explained in Section 19.3.
5. Push the firing pin retaining pin out of the bolt carrier from right to left by using the corner of one of the charging handles (Figure 28).
6. Remove the firing pin from the rear of the bolt carrier (Figure 29).
7. Remove the bolt cam pin from the left side of the bolt (Figure 30).
8. Remove the bolt from the front of the bolt carrier (Figure 31).

FIGURE 28

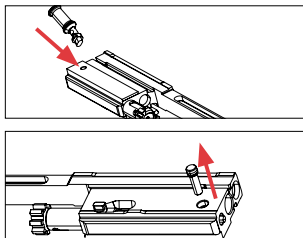

Use the charging handle to remove the firing pin retaining pin.

FIGURE 29

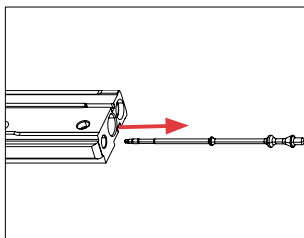

Remove the firing pin.

FIGURE 30

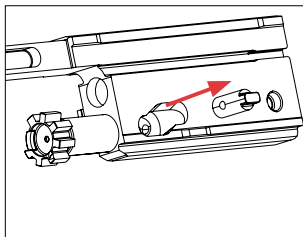

Remove the bolt cam pin.

FIGURE 31

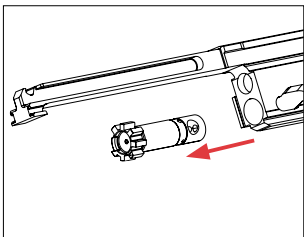

Remove the bolt.

19.5 REMOVAL OF THE GAS REGULATOR AND GAS PISTON

1. Remove the magazine and make certain the rifle is completely unloaded and the safety selector is in the “on safe” position as explained in Section 9. Make sure the bolt is forward on an empty chamber as explained in Section 10.
2. Remove the trigger module as explained in Section 19.1.
3. Remove the buttstock module as explained in Section 19.2.
4. Remove moving parts assembly as explained in Section 19.3.

5. If the gas regulator is not already in the 12 o'clock position, turn the gas regulator to the 12 o'clock position.
6. Use the small end of the bent charging handle or a small 1/8" flat screwdriver to push in on the gas regulator detent and turn the gas regulator clockwise to the 4 o'clock position (Figure 32).
7. Remove the gas regulator from the front of the gas block (Figure 33).

FIGURE 32

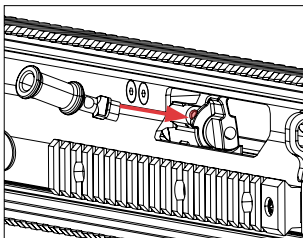

Push the detent and rotate the gas regulator.

FIGURE 33

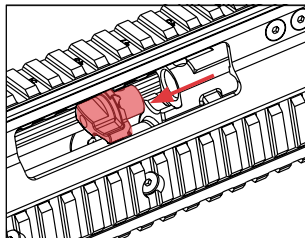

Remove the gas regulator.

8. Place the muzzle down on a soft surface. Lower a cleaning rod (with a 5.56mm or .223 bronze cleaning brush attached) down through the receiver until it comes in contact with the gas piston.
9. Softly tap the piston and it will come out of the front of the gas block.

NOTICE! DO NOT TAKE YOUR FIREARM'S ACTION APART BEYOND WHAT IS EXPLAINED IN THIS OWNER'S MANUAL. THIS IS A SPECIALIZED, FINELY FITTED MECHANISM; ANY ATTEMPT TO DISASSEMBLE THE INNER MECHANISM MAY PERMANENTLY DAMAGE IT. IT IS UNNECESSARY, AND MAY DO DAMAGE TO THE INNER MECHANISM TO DISASSEMBLE IT FOR ROUTINE CLEANING AND OILING. OF COURSE, MISFORTUNES (SUCH AS DROPPING YOUR FIREARM IN WATER) REQUIRE APPROPRIATE ATTENTION,

AND IN SUCH CIRCUMSTANCES, WE RECOMMEND YOU IMMEDIATELY CONTACT THE FN SERVICE CENTER OR TAKE YOUR FIREARM TO A QUALIFIED GUNSMITH.

20. CLEANING AND LUBRICATION

▲WARNING

BEFORE PERFORMING CLEANING PROCEDURES, PLACE THE SAFETY SELECTOR IN THE “ON SAFE” POSITION. REMOVE THE MAGAZINE, LOCK OPEN THE BOLT AS EXPLAINED IN SECTION 10.2 AND MAKE CERTAIN THE CHAMBER IS COMPLETELY UNLOADED. KEEP THE MUZZLE POINTED IN A SAFE DIRECTION. FAILURE TO FOLLOW THESE WARNINGS COULD RESULT IN SERIOUS INJURY OR DEATH.

WEAR EYE PROTECTION WHEN DISASSEMBLING AND CLEANING YOUR RIFLE TO PREVENT SPRINGS, SPRING-LOADED PARTS, SOLVENTS OR OTHER AGENTS FROM CONTACTING YOUR EYES, RESULTING IN INJURY. KEEP ALL AMMUNITION AWAY FROM THE CLEANING AREA. NEVER TEST THE MECHANICAL FUNCTION OF YOUR RIFLE WITH LIVE AMMUNITION. FAILURE TO FOLLOW THESE WARNINGS COULD RESULT IN SERIOUS INJURY OR DEATH.

20.1 CLEANING PROCEDURES

Your FN SCAR 20S will function more reliably and accurately over a longer period if it is properly maintained and kept clean. Clean your firearm after every day of shooting, and more often if it becomes excessively dirty during your shooting session. A minimum cleaning includes wiping down the firearm and lubricating key parts. Regular maintenance will also include cleaning the barrel and gas system.

If you encounter a function problem be sure to give your firearm a thorough cleaning to see if it solves the problem before seeking the services of the FN Service Center in Columbia, South Carolina, or a qualified gunsmith.

1. Remove the magazine and make certain the rifle is completely unloaded and the safety selector is in the “on safe” position as

explained in Section 9.

2. Disassemble the rifle as explained in Section 19.
3. Inspect the chamber and bore for powder fouling. A normal amount of powder residue can be expected and is not serious. It can usually be removed with a patch and military-grade cleaner/lubricant. Use a rifle cleaning rod with a brass jag and patch large enough for a snug fit in the bore. Apply a small amount of military-grade cleaner/lubricant and insert the rod and patch into the barrel from the breech end and run it back and forth several times. Care should be exercised to ensure that the cleaning rod does not strike the crown of the muzzle, as damage to this area can adversely affect the accuracy of the rifle. If, or when, fouling should become heavy, it can be removed with a bronze bore brush. Dip or spray the brush with military-grade cleaner/lubricant and scrub the chamber and bore until the fouling is removed. To prevent bronze bristles from breaking off, the brush should be pushed completely through the barrel before being withdrawn.

***NOTICE!* DO NOT USE A STAINLESS-STEEL BRUSH TO CLEAN THE BORE. IT COULD DAMAGE THE CHROME PLATING.**

If necessary, clean the chamber and locking lugs using a MIL-STD 7.62mm chamber brush. Properly apply military-grade cleaner/lubricant to the brush and insert it into the chamber. Rotate the brush in a clockwise direction several times and remove.

4. After all fouling has been removed, the chamber and bore should be wiped dry. When the bore is dry, pass a patch that is lightly lubricated with military-grade cleaner/lubricant through it for preservation.
5. Inspect the barrel and chamber to be certain no patches have inadvertently been left in them. Remove any that remain.
6. Use a small brush or rag to remove dirt and foreign matter from inside the receiver and other parts of the action. Lightly lubricate all moving parts with military-grade cleaner/lubricant.

7. Use a small brush and military-grade cleaner/lubricant to clean the bolt, bolt carrier and charging sled. Wipe dry and reassemble.
8. Use a cleaning cloth to clean the gas piston. It may be necessary to use a bronze bristle brush to remove carbon build up from the piston.

NOTICE! DO NOT APPLY LUBRICANT TO THE GAS PISTON, GAS REGULATOR OR GAS BLOCK, THESE COMPONENTS ARE NOT TO BE LUBRICATED IN ANY WAY. USING LUBRICATION IN THE GAS SYSTEM COULD DAMAGE YOUR RIFLE.

9. Inspect the gas ports in the gas regulator to ensure they are free of debris and carbon build-up. If the ports are fouled, it may be necessary to use a dental pick to remove carbon build up (Figure 34).

FIGURE 34

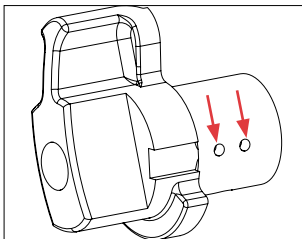

Use a dental pick to remove carbon build up from the gas ports in the gas regulator.

10. Wipe all exposed metal surfaces with a lightly oiled cloth making certain that all finger marks are removed. Finger marks provide a place where moisture can accumulate. The metal of the firearm should receive a light film of oil any time it has been exposed to weather or handling.

20.2 CLEANING THE TRIGGER MODULE

The trigger has been adjusted at the factory to provide a safe and consistent two-stage trigger pull. It is recommended that no attempt be made to change the weight of pull of the trigger.

***NOTICE!* DO NOT ALTER OR ATTEMPT TO DISASSEMBLE ANY PART OF THE TRIGGER MODULE.**

If any service of the trigger or bolt becomes necessary, send the entire rifle to the FN Service Center in Columbia, South Carolina, (Section 23) or contact your departmental armorer.

1. Remove the magazine and make certain the rifle is completely unloaded and the safety selector is in the “on safe” position as explained in Section 9.
2. Remove the trigger module as explained in Section 19.1.
3. After removing the trigger module, place the safety selector in the “off safe” position.
4. Release the hammer by placing your thumb over the hammer and pulling the trigger. Be sure to keep tension on the hammer and lower it slowly to the forward resting position.

***NOTICE!* NEVER ALLOW THE HAMMER TO SLAM FORWARD, THIS MAY DAMAGE THE TRIGGER MODULE.**

5. Perform any cleaning of the parts and receiver cavity as necessary. FN suggests cleaning the trigger group with a polymer-safe aerosol gun cleaner. Allow it to dry and then very lightly lubricate the trigger and hammer contact points.

***NOTICE!* DO NOT USE TOO MUCH LUBRICANT. EXCESSIVE LUBRICATION COULD INTERFERE WITH THE FUNCTION OF YOUR RIFLE.**

20.3 CLEANING THE MAGAZINE

⚠ WARNING

WEAR EYE PROTECTION WHEN CLEANING THE MAGAZINE TO PREVENT SOLVENT, DEBRIS OR OTHER AGENTS FROM CONTACTING YOUR EYES, RESULTING IN INJURY.

We do not recommend disassembling the magazine. Frequently inspect magazines to determine the need for cleaning as lubricant and dirt will gradually collect in the mechanism.

1. Clean the magazine by spraying it with a polymer-safe aerosol gun cleaner that will not adversely affect the follower or corrode the metal components. Spray the magazine with this solvent, both inside and out, to loosen debris.
2. Drain the solvent and residue from inside the magazine.
3. Use compressed air to dry the magazine or allow it to air dry and lightly oil.

21. ASSEMBLY

21.1 INSTALLATION OF THE GAS PISTON AND GAS REGULATOR

NOTICE! DO NOT APPLY LUBRICANT TO THE GAS PISTON, GAS REGULATOR OR GAS BLOCK, THESE COMPONENTS ARE NOT TO BE LUBRICATED IN ANY WAY. USING LUBRICATION IN THE GAS SYSTEM COULD DAMAGE YOUR RIFLE.

1. Ensure that the notches in the gas rings of the piston are not aligned (Figure 35).
2. Insert the gas piston into the gas block with the gas rings towards the muzzle.
3. Install the gas regulator, using the small end of the bent charging handle to push in on the gas regulator detent, and rotate counterclockwise to the 12 o'clock position (Figure 36).

FIGURE 35

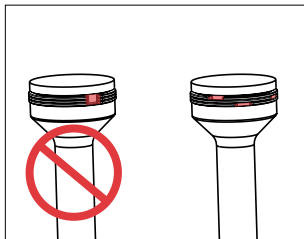

Ensure the gas rings are not aligned as shown on the left.

FIGURE 36

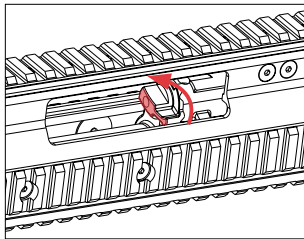

Install the gas regulator by turning counterclockwise to the 12 o'clock position.

21.2 ASSEMBLING THE MOVING PARTS ASSEMBLY

1. Insert the bolt into the front of the bolt carrier, ensure that the extractor is positioned on the right side (Figure 37).
2. Insert the bolt cam pin, ensuring the tab is horizontal (Figure 38).
3. Insert the firing pin from the rear.
4. Insert the firing pin retaining pin until firmly seated. The firing pin retaining pin will not be completely flush with the bolt carrier when fully seated.

FIGURE 37

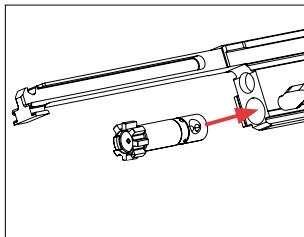

Insert the bolt into the bolt carrier.

FIGURE 38

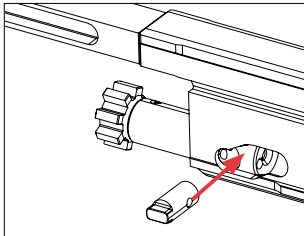

Install the bolt cam pin through the slot and into the bolt.

NOTICE! DO NOT USE EXTREME FORCE ON THE FIRING PIN RETAINING PIN, IT IS NOT DESIGNED TO FIT FLUSH INTO THE BOLT CARRIER. APPLYING EXTREME FORCE TO THE FIRING PIN RETAINING PIN COULD RESULT IN PERMANENT DAMAGE.

21.3 INSTALLATION OF THE MOVING PARTS ASSEMBLY

1. Install the charging sled, latch first and oriented up, into the top raceway in the rear of the receiver. Slide it forward until the charging handle pockets are visible in the opening at the rear of the charging handle slots (Figure 39).
2. Insert the charging handles into the charging sled (Figure 40) and slide the charging sled fully forward into its locked position. The charging handles can be placed on either side based on user preference. One or both charging handles may be used. The bent charging handle may be placed angling up or down.
3. Install the return spring assembly into the bolt carrier. Make certain that the narrow end of the guide rod retaining plate is up.
4. Ensure the upper portion of the bolt carrier is aligned with the bolt carrier guide rails inside the receiver frame and the bolt is fully forward in the bolt carrier (Figure 41).
5. Pushing on the guide rod, slide the bolt carrier all the way forward into the receiver. You may need to apply downward pressure on top of the guide rod retaining plate to clear the backplate in order to slide the moving parts assembly all the way forward (Figure 42).

IMPORTANT: BE SURE THAT THE GUIDE ROD RETAINING PLATE IS FULLY SEATED INTO THE BACKPLATE OR IT WILL PREVENT THE BUTTSTOCK FROM SLIDING INTO PLACE.

FIGURE 39

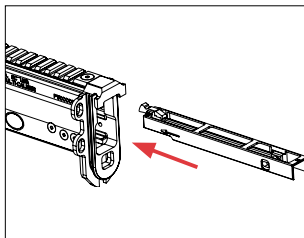

Install the charging sled, latch first into the receiver.

FIGURE 40

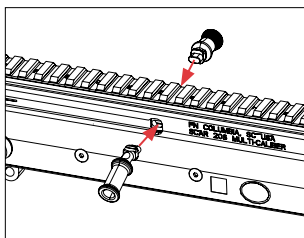

Install the charging handles and slide the charging sled forward into its locked position.

FIGURE 41

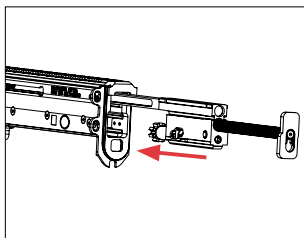

Install the bolt carrier in the receiver.

FIGURE 42

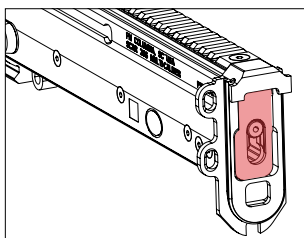

Fully seat the moving parts assembly forward in the receiver.

21.4 INSTALLATION OF THE BUTTSTOCK MODULE

1. Install the buttstock module by pressing in on the retaining plate and sliding the buttstock module on the backplate until seated (Figure 43).

21.5 INSTALLATION OF THE TRIGGER MODULE

1. Ensure that the takedown pin is pushed completely to the right of the trigger module (Figure 44).

FIGURE 43

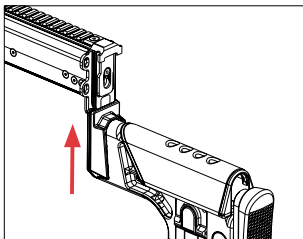

Apply finger pressure to the retaining plate and slide the buttstock module into place.

FIGURE 44

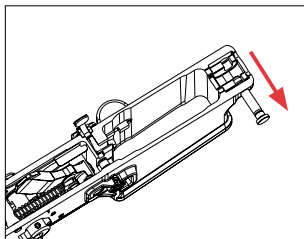

Move the takedown pin to the right side of the housing.

2. Ensure that the hammer is cocked prior to re-installing the trigger module. If the hammer is not cocked (Figure 45), press it down into the cocked position for assembly (Figure 46).
3. Place the trigger module into position, ensuring the rear extrusion engages the notch on the backplate at a slight angle (Figure 47).
4. Carefully rotate the trigger module into the receiver frame, pushing it to the rear (Figure 48).

FIGURE 45

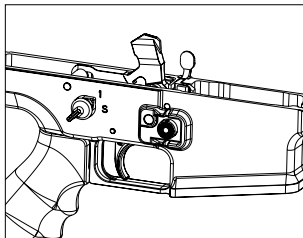

Hammer shown in the decocked position.

FIGURE 46

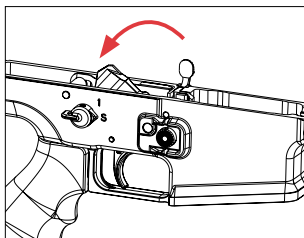

Cock the hammer by rotating it to the rear.

FIGURE 47

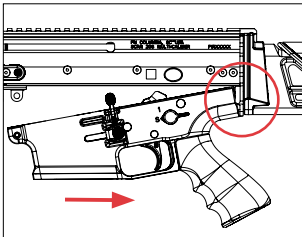

Insert the trigger module rear first into the receiver.

FIGURE 48

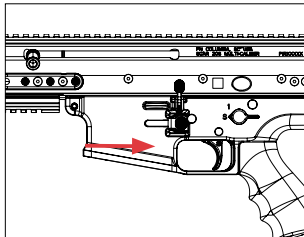

Raise the front of the trigger module into the receiver and push it rearward.

5. Ensure the trigger module is fully seated to the rear before pushing the takedown pin to the left and securing the trigger module to the receiver assembly (Figure 49). Your firearm is now fully assembled. Immediately confirm that the safety selector is in the “on safe” position. Take time to wipe down and clean all external surfaces as explained under “Cleaning and Maintenance Suggestions.” Perform the function check as explained in Section 21.6.

FIGURE 49

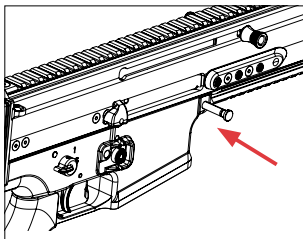

Push in the takedown pin into position.

21.6 FUNCTION CHECK

Once the rifle has been reassembled, perform a function check to ensure proper reassembly. Before conducting the function check, verify that there is no ammunition present in the chamber of the rifle, in the magazine or located within the area of your workstation. With your rifle pointed in a safe direction,

1. Operate the charging handle, making certain the bolt assembly moves freely.
2. Operate the safety selector, making certain that the safety selector moves between “on safe” and “off safe” freely.
3. Place the safety selector in the “on safe” position and properly store the rifle.

22. TAKING CARE OF THE RIFLE

***NOTICE!* FN RECOMMENDS THAT YOUR RIFLE IS INSPECTED EVERY 5,000 ROUNDS OR ONCE A YEAR BY A QUALIFIED GUNSMITH OR THE FN SERVICE CENTER BECAUSE DAMAGE, WEAR AND CORROSION ARE NOT ALWAYS VISIBLE FROM THE OUTSIDE. LAW ENFORCEMENT AND MILITARY PERSONNEL SHOULD CONTACT THEIR DEPARTMENTAL ARMORER WHO WILL INSPECT THE RIFLE ON A YEARLY BASIS.**

***NOTICE!* IF THE OPERATION OF THE RIFLE SEEMS ABNORMAL, CONTACT THE FN SERVICE CENTER OR REPORT IT TO YOUR DEALER. LAW ENFORCEMENT AND MILITARY PERSONNEL SHOULD REPORT IT TO THEIR DEPARTMENTAL OR UNIT ARMORER IMMEDIATELY.**

Your rifle will function better and more reliably over a longer period of time if it is properly maintained and cleaned.

- Always keep the rifle in immaculate condition and good working order.
- Always clean and lubricate the rifle after use.

- Do not use too much lubricant. Using too much lubricant can interfere with the function of the rifle.
- Never soak your firearm in solvents or lubricants, this could cause damage to the polymer parts or cause the rifle to malfunction.
- Regularly inspect the rifle, its parts and accessories

The frequency at which the rifle should be cleaned and lubricated depends on external factors. The weather and shooting conditions that expose your rifle to dirt, moisture, salt or sand can affect the function of your firearm.

Excessively dirty ammunition may also require more frequent cleaning. Clean and lubricate your rifle after every use or if exposed to conditions that could adversely affect the finish or function of your rifle. In the case of intensive shooting, the rifle should be cleaned every 500 rounds. A minimum cleaning includes wiping down the rifle and lubricating key parts. It is important to keep your rifle clean and correctly lubricated. Most regular maintenance also includes disassembly of the rifle and cleaning the barrel. A firearm brought out of prolonged storage should also be cleaned before shooting. Accumulated moisture and dirt, or solidified grease and oil, can prevent the firearm from operating properly.

23. WARRANTY, SERVICE AND TECHNICAL QUESTIONS

Returning your firearm for service

When returning your FN firearm for servicing you must do the following:

NOTICE! ALL FFL HOLDERS, TO AVOID UNNECESSARY RETURN SHIPPING DELAYS PLEASE SUBMIT AN FFL WHEN A FIREARM IS SENT IN FOR SERVICE.

1. Complete the online sign-up form and register to request service via FN's website, www.fnamerica.com
2. Be sure it is completely unloaded.
3. Package it securely in a double-packed cardboard container.

4. Include a copy of your service request confirmation with your firearm that clearly describes the nature of your repair concerns or service desired. If the service form is NOT included with your firearm your service will be delayed.
5. Include a daytime phone number where you can be reached.
6. Never return ammunition with your firearm. It is against postal and most commerce regulations.
7. Remove all accessories. FN America is not responsible for lost or damaged aftermarket accessories.
8. Do not remove any compliant parts or features required by law.

IMPORTANT: FN AMERICA IS NOT RESPONSIBLE FOR DAMAGE INCURRED DURING SHIPPING.

IMPORTANT: ANY ADDITION TO YOUR FN FIREARM OF AFTERMARKET ACCESSORIES (SUCH AS SUPPRESSORS, TRIGGERS, MUZZLE DEVICES, STOCKS, ETC.) IS CONSIDERED A MODIFICATION OF YOUR FIREARM FROM ITS ORIGINAL CONFIGURATION, WHICH MAY VOID YOUR WARRANTY. WE ARE UNABLE TO ADAPT EACH FIREARM FOR EVERY VARIABLE EFFECT THAT MIGHT OCCUR WHEN YOU INSTALL A THIRD-PARTY MANUFACTURER'S ACCESSORY ON AN FN FIREARM.

Therefore, FN disclaims all responsibility and liability for any damage caused to you and/or your firearm as a result of aftermarket accessory use. If an aftermarket accessory causes damage to you and/or your firearm, please address your concerns with the accessory manufacturer.

IF YOU DO NOT UNDERSTAND THE INSTRUCTIONS FOR OPERATING YOUR FN FIREARM, IT IS YOUR RESPONSIBILITY TO CONTACT FN CUSTOMER SERVICE AT 1-800-635-1321 BEFORE USING THE FIREARM.

This owner's manual should always accompany this firearm and be transferred with it upon any change of ownership.

For technical questions about service or your firearm, or if your FN product should require service or repair contact the FN Service Center in Columbia, South Carolina. Law enforcement and military users should contact their department or unit armorer.

If you have any questions about this owner's manual or other FN products, contact:

FN Service Center
797 Old Clemson Road
Columbia, SC 29229

(800) 635-1321
customerservice@fnamerica.com
www.fnamerica.com

24. TECHNICAL SPECIFICATIONS

Caliber and Twist Rate	Refer to your rifle's barrel inscription as explained in Section 11.
Length (in.)	40.6 - 42.5
Height (in.)	8
Width (in.)	3.2
Weight w/ Empty Magazine (lbs.)	11.6
Length of Pull (in.)	13.25 – 15.0
Barrel Length (in.)	20
Magazine Capacity	10-rounds (included) 20-rounds (available as an accessory)
Sight Radius	N/A
Trigger Pull (lbs.)	3.5 - 4.5 two-stage

All specifications subject to changes without notice.

NOTES

NOTES



FNAMERICA.COM