

# SAFETY EQUIPMENT OWNER'S MANUAL

**MOSSBERG®**

**#50298 LINE LAUNCHER**

AND

**#90298 CONVERSION KIT**

To be used with  
500® 6-shot and 590® 9-shot models only.



This SAFETY EQUIPMENT is designed to be used by trained personnel. Deviations from the procedures set forth in this Safety Equipment Owner's Manual or the shotgun Owner's Manual can cause serious injury, damage to this firearm or other personal property, or death.



You have a responsibility to obtain proper training on how to use and maintain this line launcher and your firearm.



Do not attempt to assemble, load or use the line launcher until you thoroughly read and understand the information contained in the shotgun Owner's Manual and the contents of this Safety Equipment Owner's Manual.



Be certain the shotgun Owner's Manual and this Safety Equipment Owner's Manual are available for reference and supplied with the Line Launcher if transferred to another party.



The Line Launcher barrel is designed to fire Mossberg® Line Launcher loads only. Take extra precautions to ensure any other type of shotshells are stored separately and not available for accidental use in the Line Launcher.

If either manual is lost or misplaced, request a free replacement copy from:

O.F. Mossberg & Sons, Inc.  
7 Grasso Ave., P.O. Box 497  
North Haven, CT 06473  
Phone: (203) 230-5300  
e-mail: O.F. Mossberg@worldnet.att.net

IMPORTANT SAFETY WARNINGS – NOTE THE SYMBOL:



These safety warnings are for your protection as well as the safety of others. Disregarding information in this manual may result in serious injury, damage to this firearm or other personal property, or death.



Line Launcher components are designed for a specific application. Do not, under any circumstances, attempt to alter or substitute the action, barrel, shaft, magazine tube extender, projectile, line, blank load or sequence of launch preparation. Any deviation may change combustion pressures resulting in launcher damage and/or serious personal injury or death if the launcher is fired.

A Carrying Case is included with the Line Launcher model and the Line Launcher Kit. The Line Launcher model includes a Mossberg® 590® 12 gauge shotgun action and the items pictured in Figure 1. The Line Launcher “kit” includes the items pictured in Figure 1 which are compatible to 12 gauge Mossberg® 590® 9-shot, or 6-shot 500® models only.

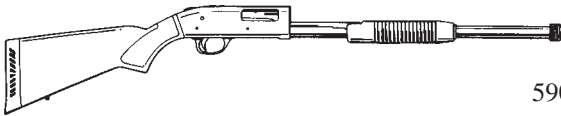

590® Action (9-shot)

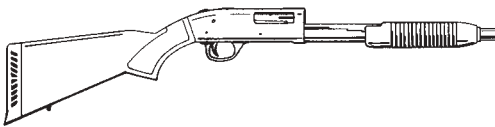

500® Action (6-shot)

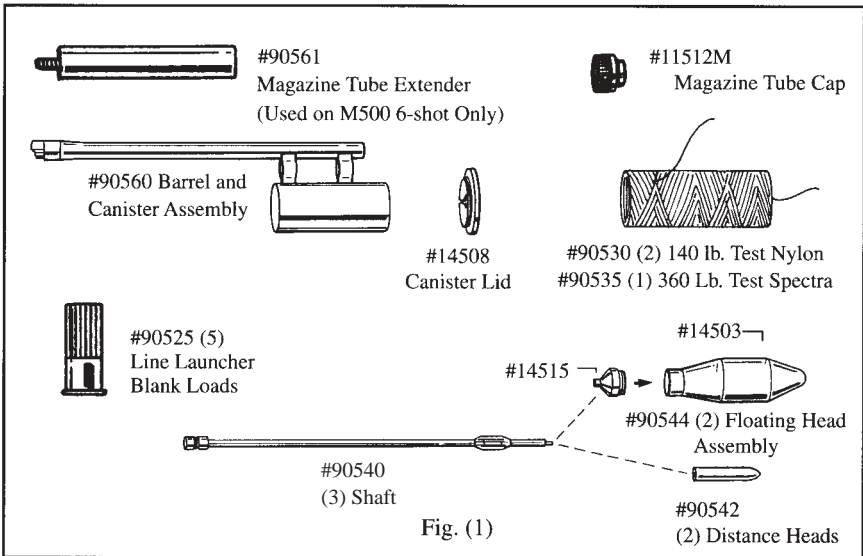

Fig. (1)



The Line Launcher is designed for 12 ga. Mossberg® 590® (9-shot capacity) and 12 ga. 500® (6-shot capacity) models with a full stock only. Do not attempt to modify any other model or brand name shotgun firearm for line launcher use.

### Preparing the Line Launcher Model and Kit



Inspect and ensure the manual safety button is fully rearward to the “ON” (SAFE) position. Visually and physically inspect the chamber, elevator and magazine tube to be sure the shotgun is completely unloaded. Point the muzzle in a safe direction, and leave the action open, with the forearm in its most rearward position.

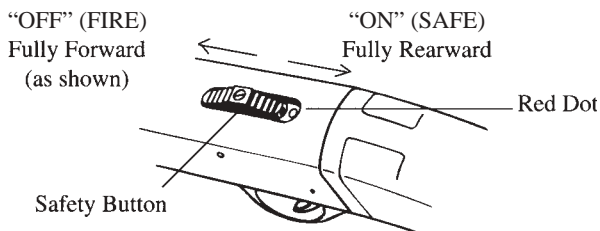

The special Line Launcher barrel, with canister attached, must be the only barrel used for line launching applications. Remove any other shotgun barrel if it is assembled to the action. Follow disassembly instructions found in the shotgun Owner’s Manual.

### 590® Line Launcher

9-shot 590 Models have the proper length (19 1/2") magazine tube. A 19 1/2" magazine tube exposed length is imperative to the Line Launcher function.

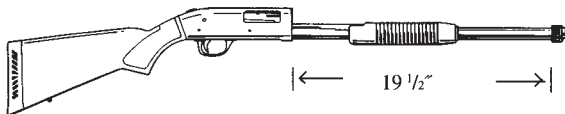

### 500® Line Launcher Kit

500® 6-shot model magazine tubes require a “magazine tube extender.” After the shotgun barrel has been removed, thread the 5 1/2" magazine tube extender to the 14" magazine tube, and hand tighten firmly. There should be no gap between the magazine tube and the magazine tube extender.

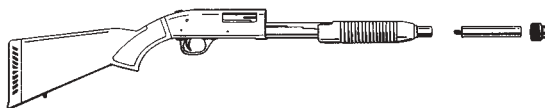

# Line Launcher Barrel Assembly



Do not use the Line Launcher barrel for anything other than line launching. Assemble the Line Launcher barrel to the shotgun as directed in the shotgun Owner's Manual.

## The Projectiles

Two types of projectile heads are available. Either head can be thread-assembled to the shaft.

The "floating" projectile has a translucent bottle head. Under calm conditions the floating projectile can travel approximately 250 feet.

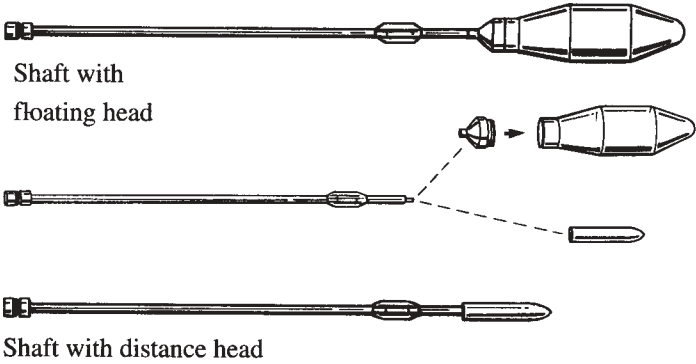

The solid point non-floating head is designed for longer range applications. Under calm conditions the non-floating projectile can travel approximately 700 to 750 feet.

Select the type of projectile head to be used, hand tighten firmly to the projectile shaft.

## Line

The line is "inside coiled" to facilitate its high speed take-off. The coiled line has no shape support once the wrapper has been removed. Carefully remove the line from its wrapper. The stationary "outer" coil line can be attached to a heavy hauling line. The traveling "inner" coil line end must be attached to the projectile shaft.

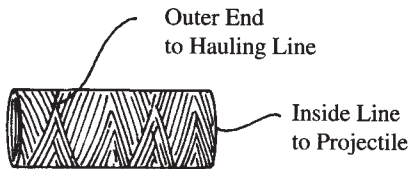

Unscrew the line canister lid. Uncoil approximately 4 feet of the outer coil line's "stationary" end. With the "inside" line end positioned forward, place the coil into the canister threading the "outside" line through the slot on the left side of the canister. Keep the muzzle in an upright position. Attach the 4 foot stationary line end to a hauling line.

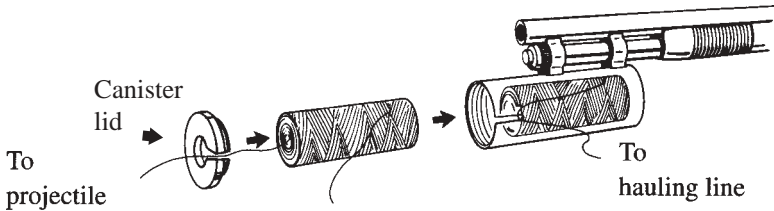

Remove 12 inches of line from the inside coil "traveling" end. Thread the 12 inch traveling end length through the canister lid hole and hand tighten the canister lid to the canister.

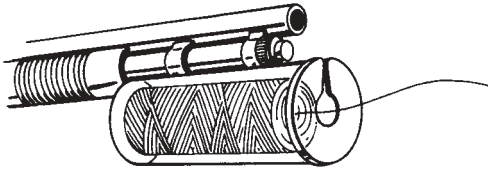

Attach the 12 inches "traveling" line to the shaft with a uni-knot.

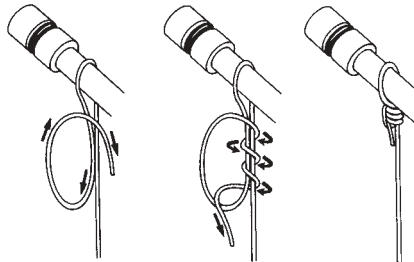

## Loading the Projectiles



Keeping the muzzle pointed in a safe upward direction, slide the projectile **fully** into the barrel. The shaft is equipped with an O-ring near the base of the shaft to help prevent the shaft from sliding forward off the face of the blank load. **The depth warning indicator on the shaft should not be visible.**



## Loading the Line Launcher



1. Use only Mossberg® approved launcher loads.
2. Keep the muzzle pointed in an upright and safe position. The shaft must remain in the most rearward position down the barrel. The depth warning indicator on the shaft should not be visible.
3. Keep the muzzle end up and away from any unintended target. Double check that the action is open, the safety button is fully rearward in the “ON” (SAFE) position and that there are no shells in the magazine tube, chamber, barrel or elevator.
4. Demand and demonstrate safe firearms handling at all times.  
Do not use the magazine tube for storage of additional ammunition.

Place one launcher load into the chamber. Close the action by moving the forearm completely forward. The launcher load will cause the shaft and the projectile to move upwards a short distance.

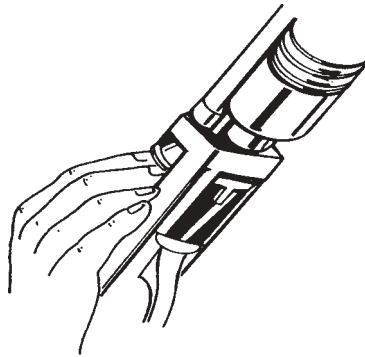

The shaft base must be in direct contact with the launcher load inside the barrel. Ensure the projectile has not moved forward inside the barrel beyond the depth warning indicator. Any gap between the shaft and the launcher load, if fired, could cause serious injury, damage to the firearm or other personal property, or death.



Firing the Line Launcher will produce substantial recoil. Fire from the standing position, with the stock firmly against the shoulder, **do not** brace against a permanent object for support. Lean forward with feet firmly planted. Leaning forward allows the body's natural motion to absorb the additional recoil. Do not creep forward on the stock, and do not allow your thumb to recoil into your nose.

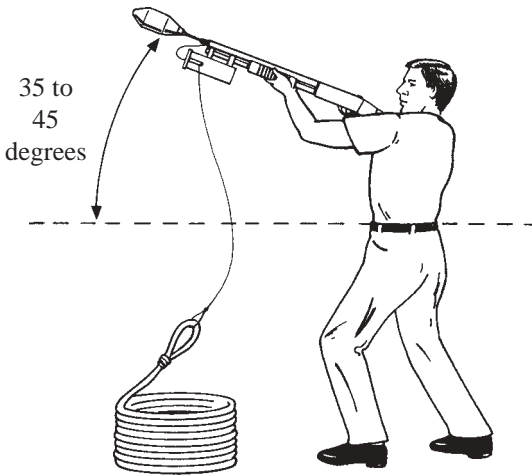

Wind will cause considerable “drift” of the line and to a lesser degree the projectile itself. Drift allowances must be established before firing. The floating head, combined with wind, line drag, and line-whipping from rapid unravelling, may cause the shaft to wobble during flight.

### Firing

Firing from and to a stationary object and with no wind affecting the projectile’s flight, the shooter should aim approximately 35 degrees to 45 degrees **over** the intended target. **Do not lower the line launcher until the projectile lands.** This enables the line to be freely released from the canister; lowering or changing the barrel’s direction immediately after firing, will cause additional “line drag” thereby reducing the projectile’s distance.



### FINAL CHECK:

1. Ensure the projectile has not moved forward beyond the depth warning indicator.
2. Ensure the “stationary” line is secured to a hauling line and that both lines are free from obstructions they may cause entanglement.
3. Spectators and assistants should be behind the shooter. No one should be allowed in front or to either side of the shooter.

When you are positioned in the direction of launch, and all safety precautions have been taken, slide the safety button fully forward to the “OFF” (FIRE) position. Pulling the trigger through its full travel to the rear will fire the launcher.



Should the blank round fail to fire, keep the launcher pointed in a safe direction. Move the safety button fully rearward to the "ON" (SAFE) position. Remove the misfired blank round and segregate from other ammunition. Do not attempt to refire a misfired blank.



If a noticeable difference in sound or recoil is experienced ...STOP! Move the safety button full rearward to the "ON" (SAFE) position. Do not attempt any other firing until after you have safely unloaded the launcher and inspected it for possible damage. If you experience recurring misfires, have the launcher examined by a competent gunsmith, or contact the Product Service Center as indicated in the shotgun Owner's Manual.

### **Cycling the Action**

To eject the spent blank casing, pull the forearm completely rearward. The spent case will eject out of the receiver through the ejection port. Be sure all observers are clear of the path of ejection. Empty cases are thrown out with significant force and could cause injury.

### **Care and Cleaning**

The Carrying Case is made of durable synthetic materials. Do not place wet or damp components of the launcher into the storage case. The Line Launcher apparatus should be thoroughly cleaned, dried and lightly oiled periodically and after each use, for continued reliable performance.



### **Replace any part that shows signs of wear or distortion.**

1. Spent line should not be reused in the line launcher. It may have suffered unnoticeable abrasions or strains which could reduce its strength and cause line breakage or premature flight stoppage if improperly coiled.
2. Inspect the shaft and projectile after each use. A bent shaft will cause dangerous chamber pressure, loss of distance and poor directional accuracy. A damaged floating projectile head will result in poor directional accuracy and may collapse or break apart from the exerted launch force if fired again. If the projectile seems damaged in any way, discard the projectile. Do not try to repair or straighten.

To order replacement parts, or should your line launcher require service, please refer to your shotgun Owner's Manual for service information and procedures.

If you do not understand any of this material in this manual or have any questions, contact O.F. Mossberg & Sons, Inc. directly.

***Safety and Safe Firearms Handling Is Everyone's Responsibility.***