Safety & Instruction Manual

G2 Contender® Pistol & Rifle



Read the instructions and
warnings in this manual
CAREFULLY BEFORE
using this firearm.

THOMPSON/CENTER ARMS
2100 Roosevelt Avenue • Springfield, MA 01104
Toll Free Phone (866) 730-1614
www.tcarms.com



WARNING



READ THESE INSTRUCTIONS AND WARNINGS CAREFULLY. BE SURE YOU UNDERSTAND THESE INSTRUCTIONS AND WARNINGS BEFORE USING THIS FIREARM. FAILURE TO READ THESE INSTRUCTIONS AND TO FOLLOW THESE WARNINGS MAY RESULT IN SERIOUS INJURY OR DEATH TO YOU AND OTHERS AND DAMAGE TO PROPERTY

This SAFETY & INSTRUCTION MANUAL should always accompany this firearm and be transferred with it upon change of ownership or when the firearm is presented to another person.

Always keep your firearm pointed in a safe direction. Never point a firearm at anything you do not intend to shoot.

If you don't have a manual, printed copies are available free upon request by contacting the factory at the address below. They are also available via download from the company's web site shown below.

**THOMPSON/CENTER ARMS
• CUSTOMER SUPPORT •**

2100 Roosevelt Avenue • Springfield, MA 01104

TEL. Toll Free (866) 730-1614

www.tcarms.com

NOTE: The G2 Contender[®], as sold by Thompson/Center, is sold as either a handgun or a rifle. Changes to the configuration of the G2 Contender[®] by the end-user, including but not limited to, a butt stock on a pistol, or a pistol barrel (under 16 inches) on a long gun, may subject the firearm to classification under the National Firearms Act, which imposes registration, taxes, and other requirements on the owners of such firearms. It is your responsibility to comply with all Federal, state and local laws and regulations regarding the ownership or possession of a firearm such as the G2 Contender[®] and any conversions or additions of any aftermarket accessories to your G2 Contender[®].

TABLE OF CONTENTS

YOUR SAFETY RESPONSIBILITIES	3-6
SAFE STORAGE AND TRANSPORTATION.....	7-8
AMMUNITION	9-10
MODEL AND FEATURES IDENTIFICATION	11-12
INSPECTING	13
INSTALLING A BARREL.....	14-15
LOADING THE G2 CONTENDER®	17
FIRING THE G2 CONTENDER®	18
CLEARING MISFIRES	21
UNLOADING.....	21
SIGHT ADJUSTMENT	22
CLEANING AND MAINTENANCE	23-25
DISASSEMBLY OF THE G2 CONTENDER®	25-26
MOUNTING A SCOPE	27-28
INSTALLATION OF CHOKE TUBES 410 BARREL.....	28-29
LIMITED LIFETIME WARRANTY	30-31
CONTACT AND SHIPPING INFORMATION	32-33
BATTERY WARNINGS	34
PATENT INFORMATION.....	35
CONTACT INFORMATION.....	36

YOUR SAFETY RESPONSIBILITIES

SAFETY IS YOUR NUMBER ONE RESPONSIBILITY!!!!

- At home, in the field, at the range, or anywhere, the first concern of every firearm owner should be safety. Apply the following safety rules in every situation, with any kind of firearm. If you feel uncertain about any operational aspects of your firearm, please contact Thompson/Center before proceeding with its operation.
- If you are unfamiliar with firearms you should seek formal training before using your firearm.



WARNING: YOU MUST FOLLOW ALL OF THESE SAFETY RULES TO ENSURE THE SAFE USE OF YOUR FIREARM. THE FAILURE TO FOLLOW THE INSTRUCTIONS AND WARNINGS IN THIS MANUAL COULD CAUSE SERIOUS PERSONAL INJURY OR DEATH TO YOU OR OTHERS AND DAMAGE TO PROPERTY.

- As a firearm owner, you accept a demanding responsibility. How seriously you take this responsibility can be the difference between life and death. There is no excuse for careless or abusive handling of your firearm. At all times handle your firearm with intense respect for its power and potential danger.

YOUR SAFETY RESPONSIBILITIES CONTINUED

- **ALWAYS KEEP YOUR FIREARM POINTED IN A SAFE DIRECTION.** Never point a firearm at anyone or anything you do not intend to shoot whether or not it is loaded. This is particularly important when loading, unloading, or field stripping the gun. ALWAYS control the direction of the firearm.
- **ALWAYS TREAT EVERY FIREARM AS IF IT IS LOADED AND WILL FIRE.** Do not take anyone's word that the firearm is unloaded – always check for yourself. Never pass your firearm to another person until the action is open and you visually check that it is unloaded. Keep your firearm unloaded and safely stored when not in use.
- **NEVER PLACE YOUR FINGER INSIDE THE TRIGGER GUARD OR ON THE TRIGGER UNLESS YOU INTEND TO FIRE.** Ensure that other objects do not touch the trigger.
- **ALWAYS BE SURE OF YOUR TARGET AND WHAT IS BEYOND IT.** Always be sure of where the bullet will strike and shoot only where there is a safe back stop free of obstructions, water or other surfaces which can cause ricochets. Be sure your bullet will stop behind your target. Bullets can glance off many surfaces like rocks or the surface of water and travel in unpredictable directions with considerable velocity. Do not fire randomly into the sky.
- **NEVER CROSS OBSTACLES SUCH AS FENCES OR STREAMS WITH A LOADED FIREARM.** Always make certain your firearm is unloaded before crossing a fence, climbing a tree, jumping a ditch or negotiating other obstacles.
- **SAFE GUN HANDLING IS YOUR PERSONAL RESPONSIBILITY AT ALL TIMES.** Firearms are dangerous and can cause serious injury or death if they are misused or used inappropriately. Safety must be the prime consideration of any one who owns or handles firearms. Accidents are the result of violating the rules of safe gun handling and common sense. Firearm safety training is available. Contact your firearms dealer, law enforcement agency, local sportsman's club, etc. for availability.
- **YOU ARE RESPONSIBLE FOR THE FIREARM AT ALL TIMES.** In owning a firearm, you must undertake full-time responsibility for your firearm's safety and security. You must protect yourself and all others against injury or death from misuse of the firearm 24 hours a day.
- **FIREARM SECURITY IS YOUR RESPONSIBILITY.** You must secure firearms safely from children and/or unauthorized users. Your firearm should always be kept unloaded and locked when not in use. Never assume that the use of this lock is sufficient to safely secure your firearm. You must always evaluate your personal situation and employ the security systems that meet your needs and prevent children and unauthorized users from gaining access to your firearm.

YOUR SAFETY RESPONSIBILITIES CONTINUED

- **APPROPRIATE USE FOR YOUR FIREARM MEANS USING YOUR FIREARM FOR LEGAL PURPOSES.** For example - target shooting, hunting and lawful resistance of deadly criminal force. It is your responsibility to ensure that you are in compliance with all applicable laws and ordinances regarding the use of your firearm.
- **NEVER RELY ON MECHANICAL FEATURES ALONE.** Only your safe gun-handling habits will ensure the safe use of your firearm. This is your responsibility.
- **ALWAYS SAFELY STORE AND SECURE YOUR FIREARM.** Safe and secure storage of your firearm is one of your most important responsibilities. It is a full-time responsibility. You must always secure your firearm and ammunition separately so that they are not accessible to children and/or other unauthorized persons.
- **NEVER KEEP AMMUNITION IN THE SAME LOCATION AS THE FIREARM.** Store each in a separate and secure place.
- **ALWAYS WEAR EYE PROTECTION THAT IS SPECIFIED FOR USE WITH FIREARMS** every time you handle your firearm for cleaning and maintenance.
- **ALWAYS WEAR EYE AND HEARING PROTECTORS THAT ARE SPECIFIED FOR USE WITH FIREARMS** every time you discharge your firearm. Make sure others in the vicinity of where you will be shooting do so as well.
- **NEVER USE ALCOHOL OR DRUGS BEFORE OR WHILE SHOOTING.** Do not use your firearm if you are on any medication which impairs, even slightly, your mental or physical ability.
- **ALWAYS HAVE ADEQUATE VENTILATION.** Discharging firearms in poorly ventilated areas, cleaning firearms, or handling ammunition may result in exposure to lead and other substances known to cause birth defects, reproductive harm, and other serious physical injury. Review the warnings and labels for all ammunition and cleaning products carefully. Wash hands thoroughly after exposure.
- **BEFORE HANDLING ANY FIREARM, UNDERSTAND ITS OPERATION.** Not all firearms are the same. Familiarize yourself with the mechanical features of any firearm you intend to use. If you feel uncertain about any operational aspects of your firearm, please contact Thompson/Center, before proceeding with its operation.
- **NEVER ALLOW A FIREARM TO BE USED BY INDIVIDUALS WHO DO NOT UNDERSTAND ITS SAFE OPERATION OR HAVE NOT READ THESE FIREARM SAFETY RULES.**

YOUR SAFETY RESPONSIBILITIES CONTINUED

- **ALWAYS USE THE CORRECT AMMUNITION FOR YOUR PARTICULAR FIREARM** as indicated by the marking on the firearm. Never use non-standard, reloaded, or “handloaded” ammunition which has not been subjected to internal ballistic pressure testing.
- **BEWARE OF BARREL OBSTRUCTIONS** Be sure the barrel is clear of obstructions before shooting. Mud, water, snow or other objects may inadvertently lodge in the barrel bore. A small obstruction can cause a dangerous increase in pressure and may damage your gun and cause injury to yourself and others.
- **BE SURE ALL ACCESSORIES, SUCH AS HOLSTERS, GRIPS, SLINGS, SCOPES AND OTHER ACCESSORIES ARE COMPATIBLE** with the firearm and that the accessories do not interfere with safe operation. It is your responsibility to understand and follow all of the instructions in this manual, as well as those which may be supplied with your ammunition and any accessory.
- **NEVER DISASSEMBLE YOUR FIREARM** beyond the field stripping procedure outlined in this manual. Improper disassembly or reassembly of your firearm may be dangerous and can lead to serious injury or death.
- **NEVER MANIPULATE, ADJUST OR CHANGE ANY OF THE INTERNAL COMPONENTS OF YOUR FIREARM UNLESS SPECIFICALLY INSTRUCTED TO DO SO IN THIS MANUAL.** Improper manipulation of any other internal component may affect the safety and reliability of your firearm and may cause serious injury or death.
- **NEVER ALLOW ANY ALTERATION OR REPLACEMENT OF PARTS IN YOUR THOMPSON/CENTER FIREARM UNLESS PERFORMED BY A QUALIFIED GUNSMITH** using genuine Thompson/Center parts. If you do otherwise, improper functioning of your firearm may occur and serious injury or death and damage to property may result.



WARNING: SAFE USE OF A FIREARM IS YOUR PERSONAL RESPONSIBILITY AND THE FAILURE TO FOLLOW ALL OF THESE BASIC SAFETY RULES MAY RESULT IN SEVERE PERSONAL INJURY OR DEATH TO YOU OR OTHERS AND DAMAGE TO PROPERTY. YOU ARE THE MOST IMPORTANT SAFETY DEVICE WHEN IT COMES TO THE USE OF YOUR FIREARM AND THOMPSON/CENTER AND ITS PARENT COMPANY WILL NOT BE RESPONSIBLE FOR ANY PERSONAL INJURY, DEATH OR PROPERTY DAMAGE THAT RESULTS FROM: (1) THE CRIMINAL OR NEGLIGENT USE OF THIS FIREARM; (2) A DISREGARD OF THESE SAFETY INSTRUCTIONS AND WARNINGS; (3) IMPROPER OR CARELESS HANDLING OF THIS FIREARM; (4) THE USE OF NON-STANDARD, DEFECTIVE OR IMPROPER AMMUNITION; OR (5) IMPROPER OR NEGLIGENT MODIFICATIONS OR REPAIRS TO THE FIREARM.

SAFE STORAGE AND TRANSPORTATION



WARNING: ALWAYS POINT THE MUZZLE IN A SAFE DIRECTION.



WARNING: FIREARMS ARE DANGEROUS WHEN USED AND STORED IMPROPERLY. THEY POSE A RISK OF SERIOUS OR FATAL INJURIES. FIREARMS CAN BE ESPECIALLY DANGEROUS TO CHILDREN WHEN THEY ARE STORED IN AN IRRESPONSIBLE AND UNSAFE MANNER. FOR YOUR SAFETY AND THE SAFETY OF OTHERS, IT IS IMPERATIVE THAT YOU KEEP YOUR FIREARM UNLOADED AND LOCKED IN A SECURE PLACE. THE AMMUNITION SHOULD BE STORED IN A SEPARATE, SECURE LOCATION WHEN IT IS NOT IN USE. SAFE AND SECURE STORAGE OF YOUR FIREARM IS ONE OF THE MOST IMPORTANT RULES OF FIREARM SAFETY. YOUR FAILURE TO FOLLOW THESE RULES MAY RESULT IN SERIOUS INJURY OR DEATH TO YOU OR OTHERS.

- **ALWAYS SECURE YOUR FIREARM IN A MANNER THAT WILL PREVENT UNAUTHORIZED ACCESS.** Whenever your firearm is not in use, keep it unloaded and locked. Your safety and the safety of others requires that you always secure and store your firearm in a manner that will prevent unauthorized access. Never leave a firearm unattended unless it is locked, unloaded and secured.
- **ALWAYS USE THE LOCK PROVIDED BY THOMPSON/CENTER TO SECURE YOUR FIREARM.** Please read and follow the instructions packaged separately for the use of this lock. A lock, when properly used, can be an effective tool in preventing unauthorized access to your firearm. There are other alternative locks and safe storage containers available in the marketplace which may also be appropriate for your particular needs. Consult your local gun shop, hardware store, or local police department for guidance on the variety of other safe storage devices or practices which may be appropriate for your particular needs. By purchasing this firearm you have accepted the responsibility of safely securing the firearm at all times and preventing its unauthorized use. Never assume that the use of this lock alone is sufficient to safely secure your firearm. It is your personal responsibility to select and use whatever measures or practices that will enable you to be absolutely certain that your firearm is secure at all times.



WARNING: NEVER LOCK A LOADED FIREARM AND NEVER LOAD A LOCKED FIREARM!!

SAFE STORAGE AND TRANSPORTATION CONTINUED

- **ALWAYS STORE YOUR FIREARM AND AMMUNITION SEPARATELY** so that they are not accessible to children or other unauthorized persons. Safe and secure storage of your firearm and ammunition are your responsibility. It is a full-time responsibility.
- **NEVER ASSUME THAT A “HIDING” PLACE IS A SECURE STORAGE METHOD.** Others may be aware of your storage location or come upon it by chance. It is your personal responsibility to use common sense when storing your firearm and ammunition and to always make sure they are not accessible to children or other unauthorized persons.
- **NEVER TRANSPORT A LOADED FIREARM.** When transporting your firearm, be sure it is unloaded and locked. Safe and secure transportation of your firearm is your responsibility.
- **ALWAYS FOLLOW THE LAW!** Many jurisdictions have laws that make it a crime to keep a firearm unlocked and in an area accessible to children or others. Keeping a firearm locked and unloaded when not in use is not only common sense safety practice... IT IS THE LAW. You must be familiar with all local, state, and federal laws regarding the safe storage and transportation of your firearm. Failure to know and follow the law may result in unauthorized access or use of your firearm by another. Obey all laws relating to the storage and transportation of firearms. Your local police department or gun shop can furnish you with available information on storing and/or transporting a firearm safely and legally.
- **YOUR FIREARM IS YOUR RESPONSIBILITY.** You must prevent your firearm from being stolen or from being used by untrained or unqualified individuals. Keep it locked, unloaded and secured when not in use. Use the lock provided to secure against unauthorized users.

AMMUNITION



WARNING: NEVER USE AMMUNITION NOT SPECIFICALLY DESIGNATED FOR USE IN YOUR FIREARM. FAILURE TO USE THE CORRECT TYPE OR CALIBER OF AMMUNITION MAY CAUSE THE FIREARM TO JAM, OR FAIL TO FIRE, OR MAY GENERATE EXCESSIVE PRESSURE WHICH CAN DAMAGE OR EVEN RUPTURE YOUR FIREARM, CAUSING PERSONAL INJURY OR DEATH TO THE SHOOTER OR BYSTANDERS.

- Locate the cartridge designation marked on the barrel. This information indicates the correct ammunition that must be used in this firearm (FIGURE 1).

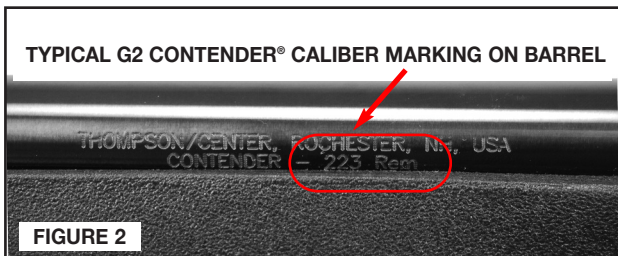

- You are responsible for selecting ammunition that meets industry standards and is appropriate in type and caliber for this firearm.
- Never mix ammunition.



WARNING: IN SOME CASES, A ROUND OF AMMUNITION NOT SPECIFIED ON YOUR FIREARM AND NOT LISTED AS ALTERNATE AMMUNITION IN THIS MANUAL, MAY FIT INTO THE CHAMBER. FIRING THIS AMMUNITION MAY CAUSE A RUPTURE RESULTING IN DAMAGE TO THE FIREARM AND PERSONAL INJURY OR DEATH TO THE SHOOTER OR BYSTANDERS. FOR MORE INFORMATION REGARDING UNSAFE CALIBER COMBINATIONS, REFER TO THE FOLLOWING URL:

[HTTP://WWW.SAAMI.ORG/SPECIFICATIONS_AND_INFORMATION/PUBLICATIONS/DOWNLOAD/SAAMI_ITEM_211-UNSAFE_ARMS_AND_AMMUNITION_COMBINATIONS.PDF](http://www.saami.org/specifications_and_information/publications/download/saami_item_211-unsafe_arms_and_ammunition_combinations.pdf)



WARNING: ALWAYS INSPECT YOUR AMMUNITION BEFORE USING IT. NEVER USE DIRTY, CORRODED OR DAMAGED AMMUNITION. A BURST CARTRIDGE MAY RESULT CAUSING DAMAGE TO THE FIREARM AND PERSONAL INJURY OR DEATH TO THE SHOOTER OR BYSTANDERS.

- Use only commercially manufactured ammunition with internal ballistic pressures which are in strict accordance with the specifications of the Sporting Arms and Ammunition Manufacturers' Institute (SAAMI). If you are uncertain, contact your ammunition supplier for verification.

AMMUNITION CONTINUED



WARNING: NEVER USE NON-STANDARD, RELOADED OR “HANDLOADED” AMMUNITION WHICH HAS NOT BEEN SUBJECTED TO INTERNAL BALLISTIC PRESSURE TESTING. RELOADED OR HANDLOADED AMMUNITION, MAY HAVE MANY MANUFACTURING AND QUALITY VARIABLES (SUCH AS THE TYPE AND AMOUNT OF GUN POWDER). CARTRIDGE CASES THAT HAVE BEEN RELOADED AND FIRED MULTIPLE TIMES MAY SUFFER PHYSICAL DAMAGE WHICH COULD SIGNIFICANTLY IMPACT OR REDUCE THE INTEGRITY OF THE CARTRIDGE, POSSIBLY RESULTING IN BULLET SETBACK OR UNSEATING. CASE FAILURE AND INJURY TO THE SHOOTER OR BYSTANDERS AND DAMAGE TO THE FIREARM MAY RESULT WHEN SUCH A ROUND IS FIRED. ANY AMMUNITION THAT IS IMPROPERLY MANUFACTURED OR RELOADED, EVEN IN THE SLIGHTEST DEGREE, MAY FAIL TO FIRE OR MAY GENERATE EXCESSIVE INTERNAL PRESSURES WHICH CAN DAMAGE OR EVEN RUPTURE THE FIREARM, CAUSING PERSONAL INJURY OR DEATH TO THE SHOOTER OR THOSE IN THE IMMEDIATE VICINITY.

- A firearm and ammunition are a system and must work together. There are different types of ammunition for different types of firearms. Your firearm has been designed for ammunition of a specific type and a specific gauge or caliber. It is important to select the proper ammunition for your firearm.
- Different combinations of bullet velocity, bullet weight and firearm weight can have major impact on felt recoil; a high level of felt recoil can be uncomfortable to some shooters.



WARNING: NEVER USE AMMUNITION OF THE INCORRECT GAUGE OR CALIBER. USING AMMUNITION OF THE INCORRECT GAUGE OR CALIBER MAY CAUSE DAMAGE TO YOUR FIREARM AND POSSIBLE SERIOUS INJURY TO YOU AND TO OTHERS.



WARNING: DEATH, SERIOUS INJURY AND PROPERTY DAMAGE CAN RESULT FROM THE USE OF INCORRECT AMMUNITION OR BORE OBSTRUCTIONS. NEVER USE RELOADED AMMUNITION THAT HAS NOT BEEN SUBJECTED TO INTERNAL BALLISTIC PRESSURE TESTING.



WARNING: DISCHARGING FIREARMS IN POORLY VENTILATED AREAS, CLEANING FIREARMS, OR HANDLING AMMUNITION MAY RESULT IN EXPOSURE TO LEAD AND OTHER SUBSTANCES KNOWN TO CAUSE BIRTH DEFECTS, REPRODUCTIVE HARM, AND OTHER SERIOUS PHYSICAL INJURY. HAVE ADEQUATE VENTILATION AT ALL TIMES. WASH HANDS THOROUGHLY AFTER EXPOSURE.

MODEL AND FEATURES IDENTIFICATION

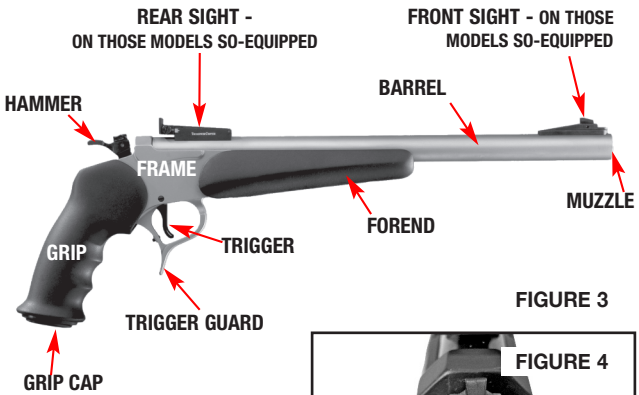

FIGURE 3

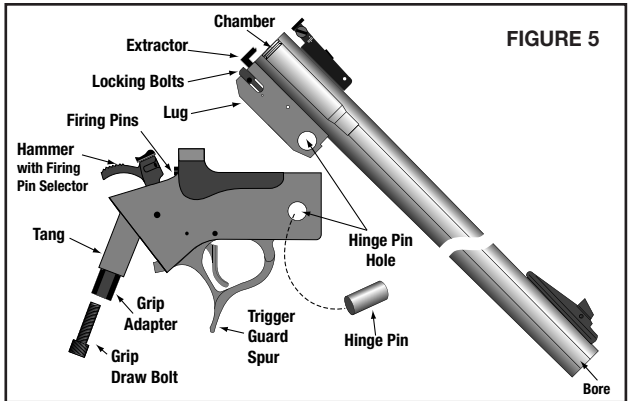
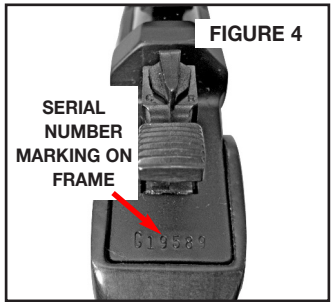
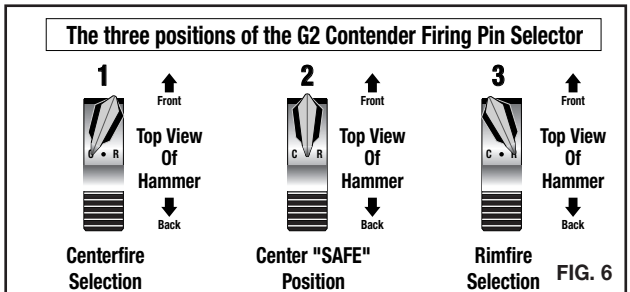

FIGURE 5



MODEL AND FEATURES I.D. CONTINUED

MANUFACTURER MARKING ON THE BARREL



"TCA - G2"
MARKING ON
OLDER FRAME
INDICATES G2
CONTENDER®
MODEL



MARKING
ON FRAME
INDICATES
G2
CONTENDER®
MODEL

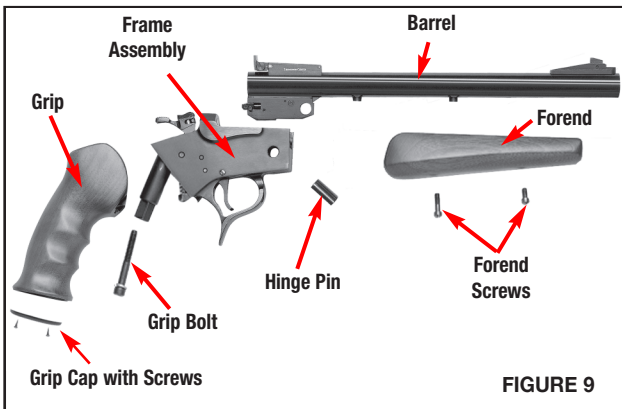

About G2 Contender® Forends:

Different G2 Contender® barrels (i.e. rifle, shotgun, pistol and muzzleloading barrels) may require different forends. Check with your dealer or consult the Thompson/Center catalog or web site for the appropriate forend for your barrel.

About G2 Contender® Interchangeability:

G2 Contender® barrels and frames come in blued and stainless steel - the blued and the stainless steel barrels and frames will interchange readily, the dimensions are the same.

INSPECTING

! WARNING: ALWAYS ENSURE THAT THE FIREARM IS UNLOADED BEFORE INSPECTING, DISASSEMBLING, ASSEMBLING OR CLEANING AND ALWAYS KEEP THE MUZZLE POINTED IN A SAFE DIRECTION.

! WARNING: ANY TIME YOU HANDLE A G2 CONTENDER®, OPEN THE ACTION AND ENSURE THAT IT IS UNLOADED.

INSPECT

- With your finger away from the trigger, with the hammer in the “AT REST” position and the firing pin selector in the center position (FIGURE 10a), open the action by pulling up and back on the trigger guard spur (FIGURES 11a and 11b).



Open the action by pulling up and back on trigger guard spur - allowing the barrel to fall open.

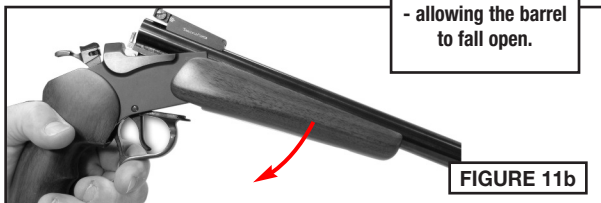

- Look into the barrel from the breech end to make sure there is no cartridge in the chamber (FIGURE 12).
- Verify that the bore is clear and free of obstructions.
- You must follow this procedure every time a firearm leaves your hand, is cleaned, handed to you or another person, transported or stored.

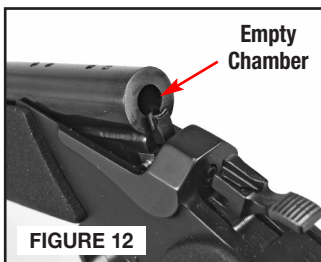

! WARNING: NEVER RELY ON MECHANICAL FEATURES ALONE. ONLY YOUR SAFE FIREARM HANDLING WILL ENSURE THE SAFE USE OF YOUR FIREARM. THIS IS YOUR RESPONSIBILITY.

INSTALLING A BARREL



WARNING: ALWAYS KEEP THE MUZZLE POINTED IN A SAFE DIRECTION.



WARNING: ALWAYS ENSURE THAT THE FIREARM IS UNLOADED WHILE INSPECTING OR ASSEMBLING.

- Before assembly, apply a light film of quality gun oil to all metal parts.
- To install a barrel and corresponding forend on the grip/frame assembly follow these steps:
- The forend must be removed from any barrel before it can be installed on the frame.

- Insert the barrel lug into the frame (FIGURE 13).

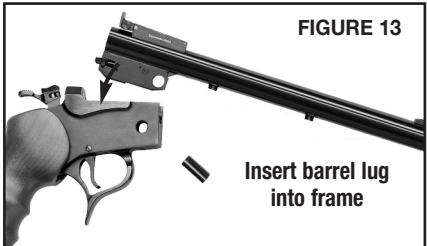

- Align the hinge pin holes of the barrel and frame and insert the hinge pin (FIGURE 14).



- With the hinge pin centered in the frame (not protruding from either side) tip the barrel up and closed on the frame (FIGURE 15).



- Install the forend onto the barrel. Place the rear of the forend against the receiver. Align the holes in the forend over the holes in the barrel (FIGURES 16 & 17) and secure the forend into place using the supplied screws.

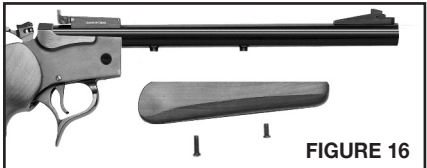

INSTALLING A BARREL CONTINUED

- With your finger away from the trigger and the hammer in the “AT REST” position, open the barrel by holding the firearm by the grip and pulling up and back on the trigger guard spur to unlock the barrel, allowing it to tip down (FIGURE 18).

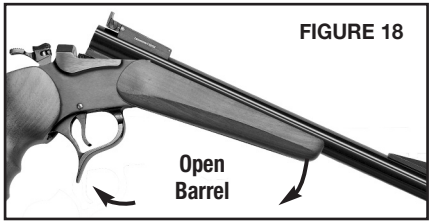

- Practice opening and closing the G2 Contender® before you attempt to load and fire it.

NOTE: To make it easier to open the G2 Contender® barrel, place your finger low on the trigger guard spur for maximum leverage, and give it a quick pull to open the barrel.



WARNING: DO NOT ADD OR REPLACE ANY OF THE PARTS IN YOUR FIREARM UNLESS THEY ARE GENUINE THOMPSON/CENTER PARTS AND YOU FOLLOW THE INSTRUCTIONS SUPPLIED. IF YOU DO OTHERWISE, IMPROPER FUNCTIONING MAY OCCUR AND SERIOUS INJURY OR DEATH MAY RESULT. IN ADDITION TO THE DANGERS PRESENTED, THE USE OF NON-FACTORY PARTS, INCLUDING BUT NOT LIMITED TO BARRELS AND SPRINGS, VOIDS ALL WARRANTIES.

- Before using your firearm for the first time, it should be cleaned. See the cleaning section of this manual for details.

PREPARATION FOR FIRING



WARNING: THE FAILURE TO FOLLOW THESE FIREARM SAFETY REQUIREMENTS WILL CAUSE SERIOUS PERSONAL INJURY OR DEATH TO YOU OR OTHERS.

- **ALWAYS TREAT ALL FIREARMS AS IF THEY ARE LOADED.**
- **ALWAYS BE SURE THAT THE CHAMBER IS CLEAR OF A CARTRIDGE AND THAT THE FIREARM IS POINTING IN A SAFE DIRECTION.**
- **ALWAYS KEEP FINGERS AND OTHER PARTS OF YOUR BODY AWAY FROM THE MUZZLE.**
- **ALWAYS WEAR ADEQUATE AND PROPER HEARING PROTECTORS SPECIFIED FOR FIREARM USE** to prevent permanent damage to your hearing. Make sure others who are nearby are wearing hearing protection as well.
- **ALWAYS WEAR SAFETY GLASSES SPECIFIED FOR FIREARM USE**, whether indoors or out. Safety glasses should protect your eyes from the firing flash and particles associated with the discharge of ammunition. Failure to do so creates a risk of personal injury from particle or debris spitting or a ricochet.
- **ALWAYS BE ALERT AND ALWAYS FOLLOW THE SAFETY INSTRUCTIONS OF THE RANGE OFFICER.** Never shoot if you are tired, cold or impaired in any way.
- **ALWAYS BE AWARE OF OTHER PEOPLE** so that persons do not accidentally walk into the line of fire.
- **THE SHOOTER (AND ALL OTHERS IN THE SHOOTING AREA) MUST ALWAYS BE IN A POSITION THAT IS OUT OF THE LINE OF FIRE** and are not within an area where they may be struck by a ricochet or particles spitting from a firearm, or by ejected cases from some types of firearms.
- **NEVER SHOOT AT SURFACES THAT MAY CAUSE A RICOCHET.** Always select a place to shoot that has a safe backstop, is free from obstructions and has no surfaces which may cause a ricochet.
- **NEVER FIRE RANDOMLY INTO THE SKY.** Always select a place to shoot that has a safe backstop.
- **NEVER USE ALCOHOL OR DRUGS BEFORE OR WHILE SHOOTING OR HANDLING ANY FIREARM.**

LOADING THE G2 CONTENDER®



WARNING: ALWAYS KEEP THE MUZZLE POINTED IN A SAFE DIRECTION.

- To load the G2 Contender®, open the action by pulling up and back on the spur of the trigger guard (FIGURE 19). The barrel tilts downward at the muzzle and a cartridge can then be inserted into the chamber (FIGURES 20 and 21).
- Push the cartridge forward into the chamber (FIGURE 21).
- Rotate the barrel up at the muzzle and close the action.
- Do not force the barrel closed on a live round. If the barrel doesn't close smoothly and easily, remove the live round from the chamber and inspect the cartridge and chamber. If you are unable to recognize and correct the problem, have the firearm examined by a gunsmith qualified to work on Thompson/Center firearms.



LOADING THE G2 CONTENDER® CONTINUED



WARNING: NEVER USE CARTRIDGES OR SHELLS OTHER THAN THOSE DESIGNATED BY THE MARKING ON THE BARREL. DOING SO CAN RESULT IN DANGEROUSLY HIGH PRESSURES THAT MAY DAMAGE THE FIREARM AND POSSIBLY CAUSE SERIOUS INJURY TO YOURSELF AND OTHERS.



WARNING: FORCING THE ACTION CLOSED ON A LIVE ROUND MAY CAUSE ACCIDENTAL DISCHARGE. AN ACCIDENTAL DISCHARGE MAY CAUSE INJURY OR DEATH TO THE SHOOTER OR BYSTANDERS AND DAMAGE TO PROPERTY.

- The instant before firing, when your complete attention is devoted to making a safe shot, load the G2 Contender®. With the muzzle pointed in a safe direction, open the action, tip the barrel down - place a cartridge in the chamber. Tip the barrel back up and lock it closed - at this point the firearm is loaded.

FIRING THE G2 CONTENDER®



WARNING: ALWAYS KEEP THE MUZZLE POINTED IN A SAFE DIRECTION.



WARNING: WEAR EYE AND HEARING PROTECTION SPECIFIED FOR FIREARM USE EVERY TIME YOU DISCHARGE YOUR FIREARM. MAKE SURE OTHERS IN THE VICINITY OF WHERE YOU WILL BE SHOOTING DO SO AS WELL.



WARNING: ALWAYS HAVE ADEQUATE VENTILATION. CLEANING FIREARMS IN POORLY VENTILATED AREAS, DISCHARGING FIREARMS, OR HANDLING AMMUNITION AND LOADING COMPONENTS MAY RESULT IN EXPOSURE TO LEAD AND OTHER SUBSTANCES KNOWN TO CAUSE BIRTH DEFECTS, REPRODUCTIVE HARM AND OTHER SERIOUS PHYSICAL INJURY. WASH HANDS THOROUGHLY AFTER EXPOSURE.



WARNING: NEVER RELY ON MECHANICAL FEATURES ALONE. ONLY YOUR SAFE FIREARM HANDLING WILL ENSURE THE SAFE USE OF YOUR FIREARM. THIS IS YOUR RESPONSIBILITY.

- Grasp firearm firmly with the trigger finger resting along and outside of the trigger guard.
- Move the Firing Pin Selector to the Centerfire or Rimfire position - depending on the cartridge being fired (FIGURE 22).
- Draw the hammer back to the full rearward “Cocked” position (FIGURE 23a).

FIRING THE G2 CONTENDER® CONTINUED

The three positions of the G2 Contender Firing Pin Selector

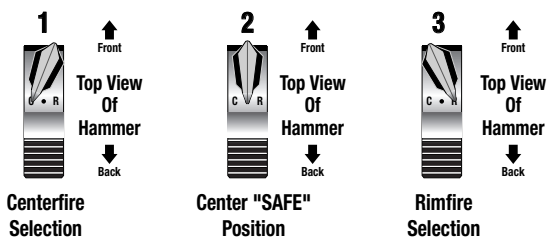
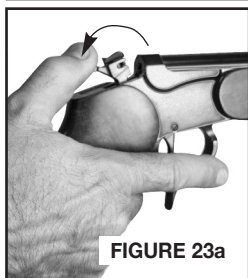
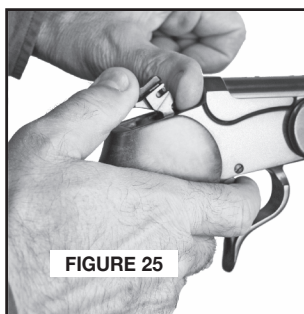
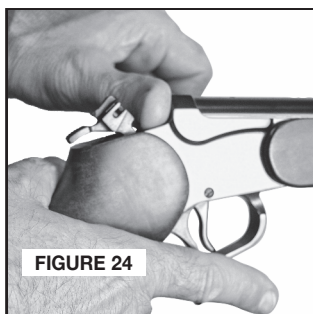

FIGURE 22



- The gun will now fire when pressure is applied to the trigger. Place your finger on the trigger and squeeze gently until the gun fires (FIGURE 23b).
- If you decide not to fire; make sure the firearm is always pointed in a safe direction - then you must carefully lower the hammer from the "Cocked" position to the "At Rest" position. To do this, place the thumb of your free hand between the hammer and the frame to prevent the hammer from moving fully forward until your finger is off the trigger and out of the trigger guard (FIGURE 24).
- Place the thumb of your firing hand on the hammer spur. You must always control the hammer with your thumbs when decocking the firearm. If the hammer slips while the trigger is held to the rear and you have failed to block the hammer travel, your firearm will fire (FIGURE 25).



FIRING THE G2 CONTENDER® CONTINUED

- Apply pressure to the trigger to release the hammer as shown (FIGURE 25). Immediately after the hammer has come out of the cocked position, release the trigger and withdraw your finger from the trigger guard (FIGURE 26).

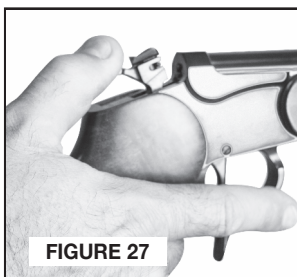
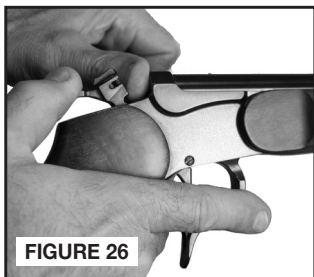

- Carefully ease the hammer forward while removing your other thumb from between the hammer and the frame (FIGURE 27) until the hammer is in the "At Rest" position (FIGURE 28).

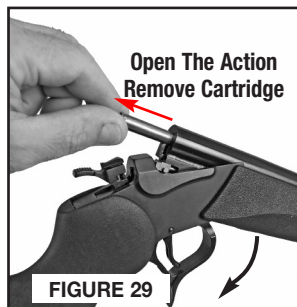
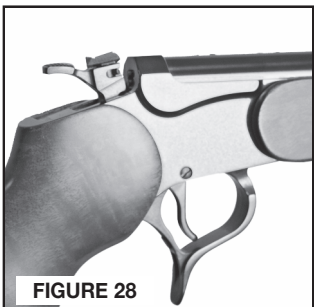

- Open the barrel and remove the cartridge from the chamber. (FIGURE 29).

WARNING: WHEN FIRING THE T/C G2 CONTENDER®, HOLD IT FIRMLY, ALLOWING YOUR BODY WEIGHT TO ABSORB AND BUFFER THE FORCE OF THE RECOIL. AN IMPROPERLY HELD FIREARM CAN CAUSE INJURY AND/OR BRUISING.

WARNING: IF YOUR FIREARM GIVES ANY INDICATION THAT IT IS NOT PERFORMING PROPERLY OR THE OPERATION OF YOUR FIREARM HAS CHANGED "THE WAY IT FEELS OR SOUNDS", STOP FIRING. MAKE SURE THE FIREARM IS POINTED IN A SAFE DIRECTION, UNLOAD THE FIREARM AND HAVE IT INSPECTED BY A FACTORY TECHNICIAN. CALL THOMPSON/CENTER CUSTOMER SUPPORT.

NOTE: Dry firing the G2 Contender® is only recommended when using "Snap Caps" of the appropriate cartridge designation.

CLEARING MISFIRES



WARNING: ALWAYS KEEP THE MUZZLE POINTED IN A SAFE DIRECTION.



WARNING: IF YOUR FIREARM GIVES ANY INDICATION THAT IT IS NOT PERFORMING PROPERLY OR THE OPERATION OF YOUR FIREARM HAS CHANGED "THE WAY IT FEELS OR SOUNDS", STOP FIRING. MAKE SURE THE FIREARM IS POINTED IN A SAFE DIRECTION, UNLOAD THE FIREARM AND HAVE IT INSPECTED BY A FACTORY TECHNICIAN. CALL THOMPSON/CENTER CUSTOMER SUPPORT.

- If a cartridge fails to fire, keep the muzzle pointed in a safe direction and wait 10 seconds before opening the barrel and removing the suspect cartridge.

UNLOADING



WARNING: ALWAYS KEEP THE MUZZLE POINTED IN A SAFE DIRECTION.

- With the hammer in the "SAFE" position, (FIGURE 30) tip the barrel open and remove the ammunition from the chamber (FIGURE 31 and 32).

The three positions of the G2 Contender Firing Pin Selector

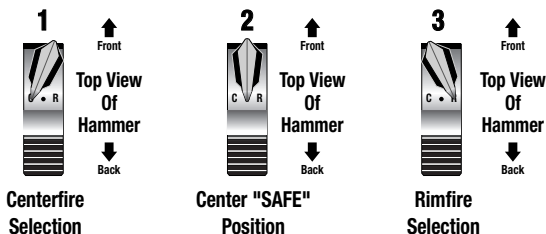
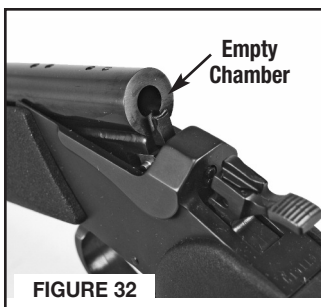
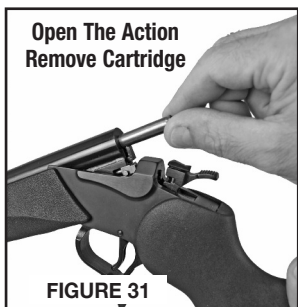

FIG. 30



SIGHT ADJUSTMENT



WARNING: ALWAYS KEEP THE MUZZLE POINTED IN A SAFE DIRECTION.



WARNING: NEVER ATTEMPT TO ADJUST ANY PART OF A LOADED FIREARM. AN ACCIDENTAL DISCHARGE CAN CAUSE INJURY AND/OR DEATH TO THE SHOOTER OR BYSTANDERS AND DAMAGE TO PROPERTY.

- On those barrels equipped with adjustable sights: The rear sight is adjustable by moving the elevation “blade” up or down to change the point of impact (FIGURE 33). Turn the Elevation adjustment screw clockwise (as viewed from the receiver end) to lower the bullet’s point of impact, and counter-clockwise, to raise the point of impact.

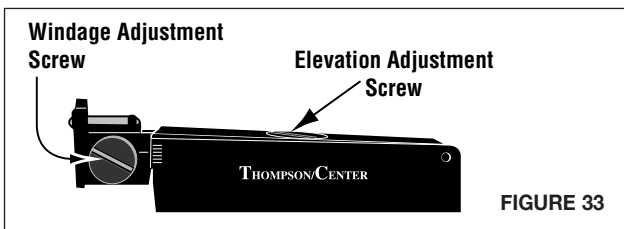

- Adjust windage by moving the rear sight leaf left or right via the slotted screw head on the side of the rear sight. Move the rear sight blade in the direction you want your shots to hit-- (Example; Turn the screw clockwise - thereby moving the sight blade to the right, to move your shots to the right and counter-clockwise to move the shots to the left).

CLEANING AND MAINTENANCE



WARNING: ENSURE THAT YOUR FIREARM IS UNLOADED BEFORE BEGINNING TO CLEAN IT. (SEE “INSPECTING YOUR FIREARM” SECTION). ALWAYS FOLLOW THE RULES OF SAFE FIREARM HANDLING.



WARNING: WEAR EYE PROTECTION SPECIFIED FOR FIREARM USE EVERY TIME YOU CLEAN OR MAINTAIN YOUR FIREARM.

- Before using your firearm for the first time, it should be cleaned.
- Your firearm was treated at the factory with either a preservative or oil to protect it against corrosion during shipping and storage.
- Preservative and oil should be wiped from the bore, chamber and exposed areas using a clean swab or patch before using the firearm.

CAUTION: Never disassemble your firearm beyond the instructions in the Field Stripping and Inspection sections of this manual.

- Purchase cleaning supplies from your firearms dealer that are specifically designated for your type and caliber of firearm. Many suppliers offer these in kit form for your convenience.
- Follow the instructions provided with your cleaning supplies.

NOTE: A basic firearm cleaning kit should include: a brass bore brush and a cleaning jag of appropriate size for the bore being cleaned, high-quality gun cleaning solvent and gun oil/lubricant, cotton cleaning patches and a cleaning rod that is long enough to push the brush and jag completely through the barrel.

- Remove excessive firing residue from the bore and chamber using a properly fitted brass brush dipped in gun cleaning solvent. Finish the bore cleaning process by running a dry cotton cloth patch through the bore to remove residue and solvent.
- Clean the exterior of the firearm using a non-abrasive cleaning cloth.
- After cleaning, lightly coat the metal parts, internal and external with a high quality firearm oil.
- Whenever your firearm has been exposed to sand, dust, extreme humidity, water or other adverse conditions, it must be cleaned and lubricated.

CLEANING AND MAINTENANCE CONTINUED

CAUTION: Always follow the instructions provided with your gun cleaner and gun lubricant.

CAUTION: Some cleaners can cause damage to your firearms. You should avoid prolonged solvent immersion and prolonged ultrasonic cleaning of your firearm. Choice of solvent should be restricted to those products specifically developed for firearms maintenance. Damage to a firearm's finish may occur if these cautions are ignored. Ammoniated solvents or other strong alkaline solvents, should not be used on any Thompson/Center firearm.

- Cleaning is essential to ensure the proper functioning of your firearm.
- Your firearm is a precision instrument. To ensure reliable function it is necessary to follow a routine maintenance procedure. After firing your firearm, be sure to unload it following the procedure outlined in the section entitled "Inspecting Your Firearm" before performing any cleaning or maintenance procedure.
- Remove any gun cleaning solution, oil and fingerprints from the outside surfaces of the firearm. (Finger moisture, if left, could start a corrosion process.)



WARNING: NEVER MANIPULATE, ADJUST OR CHANGE ANY OF THE INTERNAL COMPONENTS OF YOUR FIREARM UNLESS SPECIFICALLY DIRECTED TO DO SO IN THIS MANUAL. IMPROPER MANIPULATION OF ANY INTERNAL COMPONENT MAY AFFECT THE SAFETY AND RELIABILITY OF YOUR FIREARM AND MAY CAUSE SERIOUS INJURY OR DEATH. IT ALSO VOIDS YOUR WARRANTY.



WARNING: ANY MAINTENANCE, ADJUSTMENT OR SERVICE NOT SPECIFIED IN THIS MANUAL MAY AFFECT THE SAFETY AND RELIABILITY OF YOUR FIREARM AND MUST BE PERFORMED BY A QUALIFIED GUNSMITH USING GENUINE THOMPSON/CENTER PARTS. IF YOU DO OTHERWISE, IMPROPER FUNCTIONING OF YOUR FIREARM MAY OCCUR AND SERIOUS INJURY OR DEATH MAY RESULT.

- If your firearm will be used in a cold climate, be sure to use an oil of an appropriate weight so that it will not congeal in cold temperatures, causing the interaction of important parts to be slowed or halted.

CLEANING AND MAINTENANCE CONTINUED

MAINTENANCE BEFORE STORAGE

- When storing, do not encase your firearm in anything that will attract or hold moisture, for example, leather or heavy cloth. Also, do not store guns with a plug inserted in the barrel for this can be a contributing factor to moisture accumulation. If your firearm is to be stored for an extended period, the bore, chamber and internal surfaces should be oiled with a high-quality lubricating oil or preservative intended for firearms. The external parts; receiver, bolt and barrel should be coated with an anti-rust oil. Before using your firearm again, be sure to clean it. Every time you clean your firearm, check it for signs of wear. If wear is noted, do not use the firearm. Return it to Thompson/Center for service or have it checked by a qualified gunsmith.

DISASSEMBLY OF THE G2 CONTENDER®



WARNING: MAKE SURE THAT THE FIREARM YOU ARE HANDLING IS UNLOADED.



WARNING: ALWAYS WEAR EYE PROTECTION THAT IS SPECIFIED FOR USE WITH FIREARMS EVERY TIME YOU HANDLE YOUR FIREARM FOR CLEANING AND MAINTENANCE.

The G2 Contender® breaks down into three basic groups:

- The Frame Assembly - This assembly is held on the stock by a stock draw bolt. The fire control mechanism (hammer, sear, firing pin, etc.) is housed within the frame and the hinge pin.
- The Barrel - It is held to the receiver by the hinge pin which anchors the barrel lug to the frame.
- The Grip or Stock Assembly - The grip/stock and forend.
- Never disassemble your firearm beyond the procedures outlined in this manual. Improper disassembly or re-assembly of your firearm may be dangerous and can lead to serious injury or death.

TAKEDOWN OF THE G2 CONTENDER®.

- With the hammer in the “At Rest” position, point the firearm in a safe direction, open the action and make sure that the chamber is unloaded. Close the barrel.

DISASSEMBLY CONTINUED

- Remove the forend screw(s). Turn these screws out counter-clockwise (as viewed from the bottom of the gun). Remove the forend from the barrel.
- Open the barrel again to remove any tension on the hinge pin and remove the barrel hinge pin by tapping it out (in either direction). Remove the barrel from the frame.
- To reassemble, reverse these steps, making sure that you check for proper functioning of the hammer/trigger mechanism prior to loading and firing.

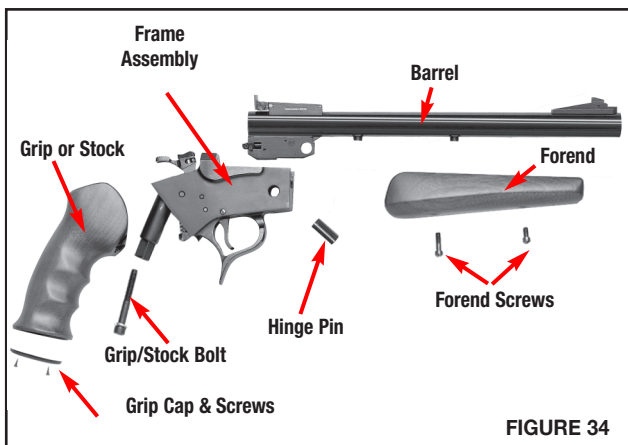

- This diagram shows the extent to which the G2 Contender[®] should be disassembled (FIGURE 34). If other service is required, contact the Thompson/Center Customer Service Department.

MOUNTING A SCOPE



WARNING: ALWAYS ENSURE THAT THE FIREARM IS UNLOADED BEFORE INSTALLING A SCOPE OR ANY OTHER ACCESSORIES. FAILURE TO DO THIS CAN CAUSE PERSONAL INJURY OR DEATH TO YOU OR OTHERS.

- We recommend that you have a competent gunsmith install your scope and mount.

Follow the instructions supplied with the scope and rings to ensure proper eye relief



- The G2 Contender® barrels are factory drilled and tapped to accept a scope mount base. Different scopes have varying lengths of recommended eye relief. You need to choose a combination that allows for adequate clearance between the scope and your eye brow. Follow the instructions supplied with the scope and rings for proper installation (FIGURE 35).

NOTE: G2 Contender® pistols are intended to be fired at arm's length. Therefore, the scope used should be designated as a "Pistol Scope". Do not use a short eye-relief scope on a pistol.



WARNING: DO NOT DRILL ADDITIONAL HOLES IN THE BARREL AS THIS COULD WEAKEN ITS STRUCTURE AND CONTRIBUTE TO A RUPTURE CAUSING INJURY AND/OR DEATH TO THE SHOOTER OR BYSTANDERS AND DAMAGE TO PROPERTY. DOING SO WILL VOID YOUR WARRANTY.



WARNING: A SCOPE WHICH IS NOT SECURELY MOUNTED MAY BECOME DETACHED UPON RECOIL OF THE FIREARM. IF IT BECOMES DETACHED IT MAY FLY BACK AND STRIKE THE SHOOTER OR A BYSTANDER AND CAUSE INJURY. OBSERVE THE CONDITION OF ALL THE SCOPE MOUNT SCREWS AFTER FIRING. IF THE MOUNTING SCREWS SHOW SIGNS OF LOOSENING DO NOT FIRE THE GUN AGAIN; CALL THE THOMPSON/CENTER CUSTOMER SERVICE DEPT. FOR ASSISTANCE 866-730-1614.

MOUNTING A SCOPE CONTINUED



WARNING: FIRING A SCOPED FIREARM WITH YOUR EYE TOO CLOSE TO THE SCOPE EYE PIECE, OR FAILING TO HOLD THE FIREARM SECURELY AGAINST RECOIL, MAY RESULT IN SERIOUS PERSONAL INJURY INCLUDING, BUT NOT LIMITED TO, BLINDNESS.

INSTALLATION of CHOKE TUBES in G2 CONTENDER® 410 GAUGE BARREL



WARNING: NEVER ATTEMPT TO INSTALL A CHOKE TUBE OR REMOVE A CHOKE TUBE FROM A LOADED FIREARM. ALWAYS ENSURE THAT THE FIREARM IS UNLOADED. FAILURE TO HEED THIS WARNING COULD RESULT IN AN ACCIDENTAL DISCHARGE CAUSING INJURY AND/OR DEATH TO THE SHOOTER OR BYSTANDERS AND DAMAGE TO PROPERTY.

- The threads of your T/C choke tubes should be kept clean and lightly lubed at all times - with a good anti-seize lubricant like Thompson/Center's Super Lube™. When installing the choke tube into the barrel, make sure the muzzle is pointed away from you in a safe direction, and never "force" the choke tube into the barrel. If the tube does not screw-in easily, the threads in the barrel or tube could be clogged, or you could be cross threading the parts. The choke tube should screw-in easily by hand. Use an appropriate wrench and tighten it until snug. **DO NOT OVER-TIGHTEN** it as it could damage the tube.

Choke tube wrench engages slots in choke tube. To install choke tube, turn clockwise. To remove, turn counter-clockwise (FIGURE 36).

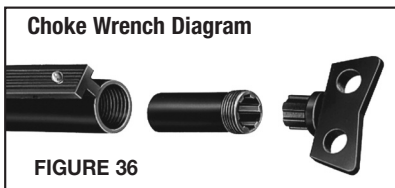

WARNING: NEVER ATTEMPT TO USE ANY OTHER BRAND CHOKE TUBE IN A THOMPSON/CENTER G2 CONTENDER®. MISMATCHING CHOKE TUBES IN ANY FIREARM COULD RESULT IN DAMAGE TO THE FIREARM, OR SERIOUS INJURY AND/OR DEATH TO THE SHOOTER OR BYSTANDERS AND DAMAGE TO PROPERTY.

INSTALLATION OF CHOKE TUBE CONTINUED

Note regarding 45 Colt/.410 Bore Shotshell Ammunition:

Internal choke pistol models are offered in 45 Colt/.410 bore allowing the use of standard 3" .410 bore shotshells. IN ALL INSTANCES, THE CHOKE TUBE MUST BE REMOVED BEFORE STANDARD BALL AMMUNITION, RIFLED SLUGS OR BUCKSHOT OF THE APPROPRIATE CALIBER IS TO BE USED.

After heavy use of shot cartridges, clean the barrel and choke tube with a tight fitting stiff bore brush to remove any accumulation of lead.

LIMITED LIFETIME WARRANTY

This warranty is granted by Smith & Wesson Corp. doing business as Thompson/Center Arms. This warranty is effective from the date of purchase for the lifetime of the original retail purchaser of any factory finished firearm. In order to be eligible for service under this warranty, the original retail purchaser must return a completed authorized warranty card or register online at <http://www.tcarms.com/warranty-details/registration> within thirty (30) days of purchase of such firearm. With respect to such firearm, this warranty supersedes any and all other warranties.

Thompson/Center Arms brand firearms are warranted to be free from defects in material and workmanship. Any such defects of which Smith & Wesson receives written notice by the original retail purchaser will be remedied without charge within a reasonable time after such notification and delivery of the firearm as provided below.

Warranty claims (in writing) and the firearm or part thereof concerned should be delivered, postage prepaid, to the factory at Smith & Wesson, 2100 Roosevelt Ave., Springfield, MA 01104, Attn: Service Department. In addition, a copy of the bill of sale in the original retail purchaser's name, or, where applicable, a copy of ATF Form 4473 indicating date of purchase must be included. Please include your physical address and phone number. You must comply with all applicable federal, state and local laws and regulations in the shipment of firearms to Smith & Wesson.

NOTE: See the Contact & Shipping section of this manual for further details regarding returns.

Warranty claims should state the model and, where applicable, the serial number of the firearm concerned and the description of the difficulty experienced. It is recommended that shipments be insured by the owner, since Smith & Wesson will accept no responsibility for loss or damage in transit. Transportation and insurance charges for return to the owner will be paid by Smith & Wesson if the claim is covered by this warranty.

If the work required is not covered by our "Limited Lifetime Warranty" you will receive a quotation which must be authorized by you. No actual work will be done without your approval. Return shipments can be shipped via UPS, FedEx or mail at your cost. Repaired product will be shipped back to you via FedEx requiring an adult signature upon receipt.

UNDER NO CIRCUMSTANCES SHALL SMITH & WESSON BE RESPONSIBLE FOR INCIDENTAL OR CONSEQUENTIAL DAMAGES WITH RESPECT TO ECONOMIC LOSS, INJURY, DEATH OR PROPERTY DAMAGE, WHETHER AS A RESULT OF BREACH OF THIS WARRANTY, NEGLIGENCE OR OTHERWISE.

Some states do not allow the exclusion or limitation of incidental or consequential damages, so the above limitation or exclusion may not apply to you.

LIMITED LIFETIME WARRANTY CONTINUED

Smith & Wesson will not be responsible for:

- Defects or malfunctions resulting from careless handling, unauthorized adjustments or modifications made or attempted by anyone other than a qualified gunsmith following authorized procedures, or failure to follow the instructions in Safety & Instruction manual that was provided with the firearm from the factory.
- Use of defective or improper ammunition and/or propellant, corrosion, neglect, abuse, ordinary wear and tear, or unreasonable use.
- Use of replacement parts, including but not limited to barrels and springs, other than factory or authorized parts.
- Criminal misuse, negligence, or use under the influence of drugs or alcohol.

Services that were performed by the Thompson/Center Arms Custom Shop and/or that are performed by the Smith & Wesson Repair Department do not void this warranty. This warranty gives you specific legal rights, and you may also have other rights which vary from state to state.

NOTE: All liability is excluded in the event that the instructions provided in the Safety and Instruction manual that was provided with the firearm from the factory are not observed.

CONTACT AND SHIPPING INFORMATION

NOTE: A Return Merchandise Authorization (**RMA**) is the first step in the process of returning a product in order to receive a repair, replacement or refund. Please contact Thompson/Center's Customer Service Dept. (e-mail: ca_customerservice@tcarms.com or by phone at 800-331-0852 ext. 4125) to obtain authorization to return your firearm so we can process it quickly and efficiently. The RMA number that is supplied by Thompson/Center Arms must be displayed on the outside of the returned product's packaging; returns without an RMA number will be routed differently which will result in delayed processing.

The issuance of an Return Merchandise Authorization (**RMA**) allows Thompson/Center Arms an opportunity to try to diagnose and correct a customer's concerns with the product (such as ammunition problems) before it is returned. Accordingly, please contact us before returning your Thompson/Center firearm.

Shipping Address: Thompson/Center Arms
2100 Roosevelt Avenue
Springfield, MA 01104

Should your Thompson/Center firearm require service, it should be returned to the Thompson/Center factory.

- Call or e-mail the Customer Service Dept. for authorization and shipping instructions.
- Ensure that the magazine and chamber are unloaded.
- Do not attempt to ship a firearm via US Postal Service; only federally licensed dealers may ship a firearm by US Postal Service.
- DO NOT SHIP ANY AMMUNITION.
- Enclose a letter which includes your full name and address (no P.O. Boxes, please), daytime telephone number, e-mail address, the serial number of the firearm, and details of the problem experienced (stating the brand and type of ammunition used when the problem occurred) or work desired.
- Record the serial number before shipping, in case you wish to check on the repair status of your firearm.
- Please remove all custom parts and accessories, such as stocks, special sights and scopes, or slings from your firearm before returning.
- Place the firearm in its original case or in a similarly secure container and pack it securely.

CONTACT & SHIPPING CONTINUED

- The package must NOT bear any markings which indicate the identity of the contents.
- It is most important that you comply with federal, state, and local laws and regulations. The following guidelines are meant to help, but you must seek assistance from the appropriate authorities if necessary.
- If your firearm must be replaced, it may be necessary to ship the replacement to a dealer rather than directly to you. You may be requested to furnish a signed FFL (Federal Firearms License) from your dealer in such an instance.
- Warranty repair work will begin upon receipt and examination of the firearm. In the case of repairs or work not covered by the warranty, a quotation covering the cost of the work plus shipping charges will be sent to you. Repairs or modification will be scheduled upon receipt of payment.



WARNING: YOU MAY PURCHASE ACCESSORIES FOR YOUR THOMPSON/CENTER FIREARM. YOU MUST HAVE SOME OF THESE PARTS INSTALLED BY A GUNSMITH QUALIFIED TO PERFORM SERVICE ON THOMPSON/CENTER FIREARMS. NEVER ATTEMPT TO MODIFY YOUR FIREARM OR INSTALL REPLACEMENT PARTS IN YOUR FIREARM. ALWAYS USE A QUALIFIED THOMPSON/CENTER GUNSMITH EVEN IF THE REPAIR SEEMS SIMPLE.

BATTERY WARNINGS



WARNING: IF A BATTERY OPERATED ACCESSORY OR ATTACHMENT (I.E. LASER, OPTICAL SIGHT OR FLASHLIGHT, ETC.) IS SUPPLIED OR USED WITH THIS FIREARM, THE FOLLOWING WARNINGS AND INSTRUCTIONS MUST BE ADHERED TO.



WARNING: KEEP BATTERIES AWAY FROM CHILDREN. THERE IS A CHEMICAL BURN HAZARD ASSOCIATED WITH BATTERIES.



WARNING: IF A NEW OR USED LITHIUM BUTTON/COIN CELL BATTERY IS SWALLOWED OR ENTERS THE BODY, IT CAN CAUSE SEVERE INTERNAL BURNS AND CAN LEAD TO DEATH IN AS LITTLE AS 2 HOURS. ALWAYS COMPLETELY SECURE THE BATTERY COMPARTMENT. IF THE BATTERY COMPARTMENT DOES NOT CLOSE SECURELY, STOP USING THE PRODUCT, REMOVE THE BATTERIES, AND KEEP IT AWAY FROM CHILDREN. IF YOU THINK BATTERIES MIGHT HAVE BEEN SWALLOWED OR PLACED INSIDE ANY PART OF THE BODY, SEEK IMMEDIATE MEDICAL ATTENTION.

- When used correctly, batteries provide a safe and dependable source of portable power. However, misuse or abuse may result in leakage, fire, or explosion.
- Batteries can explode or leak and cause burns if installed backwards, disassembled, charged, or exposed to water, fire or high temperature.
- Always take care to install your batteries correctly observing the “+” and “-” marks on the battery and the device.
- Always replace the whole set of batteries at one time, taking care not to mix old and new batteries, or batteries of different types.
- Store unused batteries in their original packaging and away from metal objects that may short-circuit them.
- Remove discharged batteries from equipment promptly to avoid possible damage from leakage.
- Never dispose of batteries in fire. (Failure to observe this precaution may result in an explosion.)
- The batteries are supplied in a charged state and are not designed for recharging. Recharging may cause leakage, fire, or explosion.
- The batteries should be disposed of properly, including keeping them away from children.
- Dispose of used batteries immediately. Even used batteries may cause injury.

PATENT INFORMATION

- This product may be covered by one or more patents. Visit www.tcarms.com for virtual patent information.

CONTACT INFORMATION

T/C Mailing Address:
(for questions & comments)

Thompson/Center Arms
2100 Roosevelt Avenue • Springfield, MA 01104

T/C Shipping Address:
(for repairs or warranty work)

Thompson/Center Arms
ATTN: Repair Department
2100 Roosevelt Avenue • Springfield, MA 01104

Web Address:
www.tcarms.com

Customer Service Phone:
Toll Free (866) 730-1614

Customer Service email:
tca_customerservice@tcarms.com

