

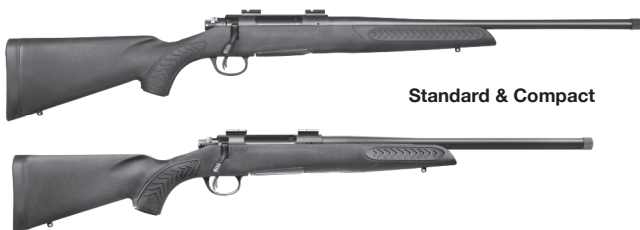

## Safety & Instruction Manual

# COMPASS<sup>®</sup> II Bolt-Action Rifles



Standard & Compact

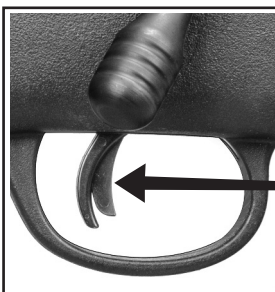

This manual applies only to COMPASS<sup>®</sup> II rifles with the Generation II non-adjustable trigger (as shown here). There is a separate manual for COMPASS<sup>®</sup> rifles with the Generation I adjustable trigger which is available for download at [www.tcarms.com](http://www.tcarms.com). Please consult the appropriate manual for the rifle you are using.



**Read the instructions and warnings in this manual CAREFULLY BEFORE using this firearm.**

**THOMPSON/CENTER ARMS**  
2100 Roosevelt Avenue  
Springfield, MA 01104  
Toll Free Phone: 800-331-0852 ext 4125  
[www.tcarms.com](http://www.tcarms.com)



**WARNING  
READ THESE**



**INSTRUCTIONS AND  
WARNINGS CAREFULLY.  
BE SURE YOU UNDERSTAND  
THESE INSTRUCTIONS AND  
WARNINGS BEFORE USING THIS  
FIREARM. FAILURE TO READ THESE  
INSTRUCTIONS AND TO FOLLOW  
THESE WARNINGS MAY RESULT IN  
SERIOUS INJURY OR DEATH TO  
YOU AND OTHERS AND  
DAMAGE TO PROPERTY**

**This SAFETY & INSTRUCTION  
MANUAL should always accompany this  
firearm and be transferred with it upon  
change of ownership or when the  
firearm is presented to another person.**

**Always keep your firearm pointed in a  
safe direction. Never point a firearm at  
anything you do not intend to shoot.**

**If you don't have a manual, printed  
copies are available free upon request  
by contacting the factory at the address  
below. They are also available  
via download at [www.tcarms.com](http://www.tcarms.com).**

**THOMPSON/CENTER ARMS**

**• CUSTOMER SUPPORT •**

**2100 Roosevelt Avenue**

**Springfield, MA 01104**

**Toll Free Phone 800-331-0852 ext 4125**

**Website: [www.tcarms.com](http://www.tcarms.com)**

**Customer Service Email:  
[tca\\_customerservice@tcarms.com](mailto:tca_customerservice@tcarms.com)**

## **TABLE OF CONTENTS**

YOUR SAFETY RESPONSIBILITIES .....	3-6
SAFE STORAGE AND TRANSPORTATION .....	7-8
PREPARATION FOR FIRING .....	9
AMMUNITION .....	10-11
MODEL AND FEATURES IDENTIFICATION .....	12
INSPECTING AND INITIAL ASSEMBLY .....	13-16
GENERATION II TRIGGER WITH SAFETY LEVER .....	16-17
LOADING .....	17-18
FIRING .....	19
CLEARING MISFIRES .....	20
UNLOADING .....	20-21
DISASSEMBLY / FIELD STRIPPING .....	22-23
MOUNTING A SCOPE .....	24
CLEANING AND MAINTENANCE .....	25-29
STOCK SPACER FOR COMPASS® II COMPACT .....	25-29
DETAILED BOLT DISASSEMBLY FOR CLEANING .....	30-31
BOLT REASSEMBLY .....	32-34
LIMITED LIFETIME WARRANTY .....	35-36
BATTERY WARNINGS .....	37
CONTACT AND SHIPPING .....	38-39
ADDRESSES AND PHONE NUMBERS & PATENT INFO ..	40

---

# **YOUR SAFETY RESPONSIBILITIES**

---

## **SAFETY IS YOUR NUMBER ONE RESPONSIBILITY!**

- At home, in the field, at the range, or anywhere, the first concern of every firearm owner should be safety. Apply the following safety rules in every situation, with any kind of firearm. If you feel uncertain about any operational aspects of your firearm, please contact Thompson/Center Arms at 800-331-0852 ext 4125 before proceeding with its operation.
- If you are unfamiliar with firearms you should seek formal training before using your rifle.



**WARNING: YOU MUST FOLLOW ALL OF THESE SAFETY RULES TO ENSURE THE SAFE USE OF YOUR FIREARM. THE FAILURE TO FOLLOW THE INSTRUCTIONS AND WARNINGS IN THIS MANUAL COULD CAUSE SERIOUS PERSONAL INJURY OR DEATH TO YOU OR OTHERS AND DAMAGE TO PROPERTY.**

- As a firearm owner, you accept a demanding responsibility. How seriously you take this responsibility can be the difference between life and death. There is no excuse for careless or abusive handling of your firearm. At all times handle your firearm with intense respect for its power and potential danger.

---

## YOUR SAFETY RESPONSIBILITIES CONTINUED

---

- **ALWAYS KEEP YOUR FIREARM POINTED IN A SAFE DIRECTION.** Never point a firearm at anyone or anything you do not intend to shoot whether or not it is loaded. This is particularly important when loading, unloading, or field stripping the firearm. ALWAYS control the muzzle direction of the firearm.
- **ALWAYS TREAT EVERY FIREARM AS IF IT IS LOADED AND WILL FIRE.** Do not take anyone's word that the firearm is unloaded – always check for yourself. Never pass your firearm to another person until the action is open and you visually check that it is unloaded. Keep your firearm unloaded and safely stored when not in use.
- **NEVER PLACE YOUR FINGER INSIDE THE TRIGGER GUARD OR ON THE TRIGGER UNLESS YOU INTEND TO FIRE.** Ensure that other objects do not touch the trigger.
- **ALWAYS BE SURE OF YOUR TARGET AND WHAT IS BEYOND IT.** Always be sure of where the bullet will strike and shoot only where there is a safe backstop free of obstructions, water or other surfaces which can cause ricochets. Be sure your bullet will stop behind your target. Bullets can glance off many surfaces like rocks or the surface of water and travel in unpredictable directions with considerable velocity. Do not fire randomly into the sky.
- **NEVER CROSS OBSTACLES SUCH AS FENCES OR STREAMS WITH A LOADED FIREARM.** Always make certain your firearm is unloaded before crossing a fence, climbing a tree, jumping a ditch or negotiating other obstacles.
- **SAFE FIREARM HANDLING IS YOUR PERSONAL RESPONSIBILITY AT ALL TIMES.** Firearms are dangerous and can cause serious injury or death if they are misused or used inappropriately. Safety must be the prime consideration of any one who owns or handles firearms. Accidents are the result of violating the rules of safe firearm handling and common sense. Firearm safety training is available. Contact your firearms dealer, law enforcement agency, local sportsman's club, etc. for availability.
- **YOU ARE RESPONSIBLE FOR THE FIREARM AT ALL TIMES.** In owning a firearm, you must undertake full-time responsibility for your firearm's safety and security. You must protect yourself and all others against injury or death from misuse of the firearm 24 hours a day.
- **FIREARM SECURITY IS YOUR RESPONSIBILITY.** You must secure firearms safely from children and/or unauthorized users. Your firearm should always be kept unloaded and locked when not in use. Never assume that the use of the provided lock is sufficient to safely secure your firearm. You must always evaluate your personal situation and employ the security systems that meet your needs and prevent children and unauthorized users from gaining access to your firearm.

---

## YOUR SAFETY RESPONSIBILITIES CONTINUED

---

- **APPROPRIATE USE FOR YOUR FIREARM MEANS USING YOUR FIREARM FOR LEGAL PURPOSES.** For example - target shooting, hunting and lawful resistance of deadly criminal force. It is your responsibility to ensure that you are in compliance with all applicable laws and ordinances regarding the use of your firearm.
- **NEVER RELY ON MECHANICAL FEATURES ALONE.** Only your safe firearm-handling habits will ensure the safe use of your firearm. This is your responsibility.
- **ALWAYS SAFELY STORE AND SECURE YOUR FIREARM.** Safe and secure storage of your firearm is one of your most important responsibilities. It is a full-time responsibility. You must always secure your firearm and ammunition separately so that they are not accessible to children and/or other unauthorized persons.
- **NEVER KEEP AMMUNITION IN THE SAME LOCATION AS THE FIREARM.** Store each in a separate and secure place.
- **ALWAYS WEAR EYE PROTECTION THAT IS SPECIFIED FOR USE WITH FIREARMS** every time you handle your firearm for cleaning and maintenance.
- **ALWAYS WEAR EYE AND HEARING PROTECTION THAT ARE SPECIFIED FOR USE WITH FIREARMS** every time you discharge your firearm. Make sure others in the vicinity of where you will be shooting do so as well.
- **NEVER USE ALCOHOL OR DRUGS BEFORE OR WHILE SHOOTING.** Do not use your firearm if you are on any medication which impairs, even slightly, your mental or physical ability.
- **ALWAYS HAVE ADEQUATE VENTILATION.** Discharging firearms in poorly ventilated areas, cleaning firearms, or handling ammunition may result in exposure to lead and other substances known to cause birth defects, reproductive harm, and other serious physical injury. Review the warnings and labels for all ammunition and cleaning products carefully. Wash hands thoroughly after exposure.
- **BEFORE HANDLING ANY FIREARM, UNDERSTAND ITS OPERATION.** Not all firearms are the same. Familiarize yourself with the mechanical features of any firearm you intend to use. If you are uncertain about any operational aspects of your firearm, contact the company before proceeding with its operation.

Thompson/Center Arms  
2100 Roosevelt Avenue, Springfield, MA 01104  
Toll Free Phone 800-331-0852 ext 4125  
tca\_customerservice@tcarms.com
- **NEVER ALLOW A FIREARM TO BE USED BY INDIVIDUALS WHO DO NOT UNDERSTAND ITS SAFE OPERATION OR HAVE NOT READ THESE FIREARM SAFETY RULES.**

---

## YOUR SAFETY RESPONSIBILITIES CONTINUED

---

- **ALWAYS USE THE CORRECT AMMUNITION FOR YOUR PARTICULAR FIREARM** as indicated by the marking on the firearm. Never use non-standard, damaged, corroded or reloaded, (handloaded) ammunition which has not been subjected to internal ballistic pressure testing.
- **BEWARE OF BARREL OBSTRUCTIONS** Be sure the barrel is clear of obstructions before shooting. Mud, water, snow or other objects may inadvertently lodge in the barrel bore. A small obstruction can cause a dangerous increase in pressure and may damage your firearm and cause injury to yourself and others.
- **BE SURE ALL ACCESSORIES, SUCH AS SLINGS, SCOPES AND OTHER ACCESSORIES ARE COMPATIBLE** with the firearm and that the accessories do not interfere with safe operation. It is your responsibility to understand and follow all of the instructions in this manual, as well as those which may be supplied with your ammunition and any accessory.
- **NEVER DISASSEMBLE YOUR FIREARM** beyond the field stripping procedure outlined in this manual. Improper disassembly or reassembly of your firearm may be dangerous and can lead to serious injury or death.
- **NEVER MANIPULATE, ADJUST OR CHANGE ANY OF THE INTERNAL COMPONENTS OF YOUR FIREARM UNLESS SPECIFICALLY INSTRUCTED TO DO SO IN THIS MANUAL.** Improper manipulation of any other internal component may affect the safety and reliability of your firearm and may cause serious injury or death.
- **NEVER ALLOW ANY ALTERATION OR REPLACEMENT OF PARTS IN YOUR THOMPSON/CENTER™ FIREARM UNLESS PERFORMED BY A QUALIFIED GUNSMITH** using genuine Thompson/Center™ parts. If you do otherwise, improper functioning of your firearm may occur and serious injury or death and damage to property may result.



**WARNING: SAFE USE OF A FIREARM IS YOUR PERSONAL RESPONSIBILITY AND THE FAILURE TO FOLLOW ALL OF THESE BASIC SAFETY RULES MAY RESULT IN SEVERE PERSONAL INJURY OR DEATH TO YOU OR OTHERS AND DAMAGE TO PROPERTY. YOU ARE THE MOST IMPORTANT SAFETY DEVICE WHEN IT COMES TO THE USE OF YOUR FIREARM AND THOMPSON/CENTER AND ITS PARENT COMPANY WILL NOT BE RESPONSIBLE FOR ANY PERSONAL INJURY, DEATH OR PROPERTY DAMAGE THAT RESULTS FROM: (1) THE CRIMINAL OR NEGLIGENT USE OF THIS FIREARM; (2) A DISREGARD OF THESE SAFETY INSTRUCTIONS AND WARNINGS; (3) IMPROPER OR CARELESS HANDLING OF THIS FIREARM; (4) THE USE OF NON-STANDARD, DEFECTIVE OR IMPROPER AMMUNITION; (5) IMPROPER OR NEGLIGENT MODIFICATIONS OR REPAIRS TO THE FIREARM.**

---

# SAFE STORAGE AND TRANSPORTATION

---



**WARNING: ALWAYS POINT THE MUZZLE IN A SAFE DIRECTION.**



**WARNING: FIREARMS ARE DANGEROUS WHEN USED AND STORED IMPROPERLY. THEY POSE A RISK OF SERIOUS OR FATAL INJURIES. FIREARMS CAN BE ESPECIALLY DANGEROUS TO CHILDREN WHEN THEY ARE STORED IN AN IRRESPONSIBLE AND UNSAFE MANNER. FOR YOUR SAFETY AND THE SAFETY OF OTHERS, IT IS IMPERATIVE THAT YOU KEEP YOUR FIREARM LOCKED AND UNLOADED IN A SECURE PLACE. THE AMMUNITION SHOULD BE STORED IN A SEPARATE, SECURE LOCATION WHEN IT IS NOT IN USE. SAFE AND SECURE STORAGE OF YOUR FIREARM IS ONE OF THE MOST IMPORTANT RULES OF FIREARM SAFETY. YOUR FAILURE TO FOLLOW THESE RULES MAY RESULT IN SERIOUS INJURY OR DEATH TO YOU OR OTHERS.**

- **ALWAYS SECURE YOUR FIREARM IN A MANNER THAT WILL PREVENT UNAUTHORIZED ACCESS.** Whenever your firearm is not in use, keep it unloaded and locked. Your safety and the safety of others requires that you always secure and store your firearm in a manner that will prevent unauthorized access. Never leave a firearm unattended unless it is locked, unloaded and secured.
- **ALWAYS USE THE LOCK PROVIDED BY THOMPSON/CENTER™ TO SECURE YOUR FIREARM.** Please read and follow the instructions packaged separately for the use of this lock. A lock, when properly used, can be an effective tool in preventing unauthorized access to your firearm. There are other alternative locks and safe storage containers available in the marketplace which may also be appropriate for your particular needs. Consult your local gun shop, hardware store, or local police department for guidance on the variety of other safe storage devices or practices which may be appropriate for your particular needs. By purchasing this firearm you have accepted the responsibility of safely securing the firearm at all times and preventing its unauthorized use. Never assume that the use of this lock alone is sufficient to safely secure your firearm. It is your personal responsibility to select and use whatever measures or practices that will enable you to be absolutely certain that your firearm is secure at all times.



**WARNING: NEVER LOCK A LOADED FIREARM AND NEVER LOAD A LOCKED FIREARM!!**

---

## SAFE STORAGE AND TRANSPORTATION CONTINUED

---

- **ALWAYS STORE YOUR FIREARM AND AMMUNITION SEPARATELY** so that they are not accessible to children or other unauthorized persons. Safe and secure storage of your firearm and ammunition are your responsibility. It is a full-time responsibility.
- **NEVER ASSUME THAT A “HIDING” PLACE IS A SECURE STORAGE METHOD.** Others may be aware of your storage location or come upon it by chance. It is your personal responsibility to use common sense when storing your firearm and ammunition and to always make sure they are not accessible to children or other unauthorized persons.
- **NEVER TRANSPORT A LOADED FIREARM.** When transporting your firearm, be sure it is unloaded and locked. Safe and secure transportation of your firearm is your responsibility.
- **ALWAYS FOLLOW THE LAW.** Many jurisdictions have laws that make it a crime to keep a firearm unlocked and in an area accessible to children or others. Keeping a firearm locked and unloaded when not in use is not only common sense safety practice... IT IS THE LAW. You must be familiar with all local, state, and federal laws regarding the safe storage and transportation of your firearm. Failure to know and follow the law may result in unauthorized access or use of your firearm by another. Obey all laws relating to the storage and transportation of firearms. Your local police department or gun shop can furnish you with available information on storing and/or transporting a firearm safely and legally.
- **YOUR FIREARM IS YOUR RESPONSIBILITY.** You must prevent your firearm from being stolen or from being used by untrained or unqualified individuals. Keep it locked, unloaded and secured when not in use.
- Use the lock provided to prevent unauthorized use, follow the instructions supplied with the lock.
- Never leave the key with the stored firearm.



---

# PREPARATION FOR FIRING

---



**WARNING: FAILURE TO FOLLOW THESE FIREARM SAFETY REQUIREMENTS WILL CAUSE SERIOUS PERSONAL INJURY OR DEATH TO YOU OR OTHERS.**

- **ALWAYS TREAT ALL FIREARMS AS IF THEY ARE LOADED.**
- **ALWAYS BE SURE THAT ALL CYLINDERS AND ACTIONS OF FIREARMS ARE OPEN, THAT CHAMBER(S) ARE CLEAR OF CARTRIDGES OR SHELLS, MAGAZINES ARE REMOVED OR UNLOADED, AND THAT FIREARMS ARE POINTING IN A SAFE DIRECTION.**
- **ALWAYS WEAR ADEQUATE AND PROPER HEARING PROTECTION SPECIFIED FOR FIREARM USE** to prevent permanent damage to your hearing. Make sure others who are nearby are wearing hearing protection as well.
- **ALWAYS WEAR SAFETY GLASSES SPECIFIED FOR USE WITH FIREARMS,** whether indoors or out. Safety glasses should protect your eyes from the firing flash and particles associated with the discharge of ammunition. Failure to wear the proper eye protection creates a risk of personal injury from particle or debris spitting or ricochets.
- **ALWAYS BE ALERT AND ALWAYS FOLLOW THE SAFETY INSTRUCTIONS OF THE RANGE OFFICER.** Never shoot if you are tired, cold or impaired in any way.
- **ALWAYS BE AWARE OF OTHER PEOPLE** so that persons do not accidentally walk into the line of fire.
- **THE SHOOTER (AND ALL OTHERS IN THE SHOOTING AREA) MUST ALWAYS BE IN A POSITION THAT IS OUT OF THE LINE OF FIRE** and are not within an area where they may be struck by a ricochet or particles spitting from a firearm, or by ejected cases from some types of firearms.
- **NEVER SHOOT AT SURFACES THAT MAY CAUSE A RICOCHET.** Always select a place to shoot that has a safe backstop, is free from obstructions and has no surfaces which may cause a ricochet.
- **NEVER FIRE RANDOMLY INTO THE SKY.** Always select a place to shoot that has a safe backstop.
- **NEVER USE ALCOHOL OR DRUGS BEFORE OR WHILE SHOOTING OR HANDLING ANY FIREARM.**

# AMMUNITION



**WARNING: NEVER USE AMMUNITION NOT SPECIFICALLY DESIGNATED FOR USE IN YOUR FIREARM. FAILURE TO USE THE CORRECT TYPE OR CALIBER OF AMMUNITION MAY CAUSE THE FIREARM TO JAM, OR FAIL TO FIRE, OR MAY GENERATE EXCESSIVE PRESSURE WHICH CAN DAMAGE OR EVEN RUPTURE YOUR FIREARM, CAUSING PERSONAL INJURY OR DEATH TO THE SHOOTER OR BYSTANDERS.**

- Locate the cartridge designation marked on the firearm. This information indicates the correct ammunition that must be used in this firearm (FIGURE 1).
- You are responsible for selecting ammunition that meets industry standards and is appropriate in type and caliber for this firearm.
- \* Never mix ammunition.

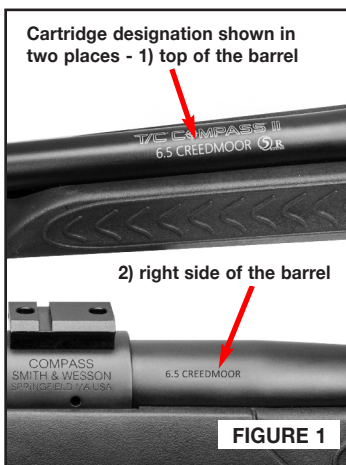

**WARNING: IN SOME CASES, A ROUND OF AMMUNITION**

**NOT SPECIFIED ON YOUR FIREARM AND NOT LISTED AS ALTERNATE AMMUNITION IN THIS MANUAL, MAY FIT INTO THE CHAMBER. FIRING THIS AMMUNITION MAY CAUSE A RUPTURE RESULTING IN DAMAGE TO THE FIREARM AND PERSONAL INJURY OR DEATH TO THE SHOOTER OR BYSTANDERS. FOR MORE INFORMATION REGARDING UNSAFE CALIBER COMBINATIONS, REFER TO THE FOLLOWING URL: [HTTPS://SAAMI.ORG/TECHNICAL-INFORMATION/UNSAFE-FIREARM-AMMUNITION-COMBINATIONS/](https://saami.org/technical-information/unsafe-firearm-ammunition-combinations/)**



**WARNING: ALWAYS INSPECT YOUR AMMUNITION BEFORE USING IT. NEVER USE DIRTY, CORRODED OR DAMAGED AMMUNITION. A BURST CARTRIDGE OR BORE OBSTRUCTION MAY RESULT CAUSING DAMAGE TO THE FIREARM AND PERSONAL INJURY OR DEATH TO THE SHOOTER OR BYSTANDERS.**

- Use only commercially manufactured ammunition with internal ballistic pressures which are in strict accordance with the specifications of the Sporting Arms and Ammunition Manufacturers' Institute (SAAMI). If you are uncertain, contact your ammunition supplier for verification.

---

## AMMUNITION CONTINUED

---



**WARNING: NEVER USE NON-STANDARD, RELOADED OR "HANDLOADED" AMMUNITION WHICH HAS NOT BEEN SUBJECTED TO INTERNAL BALLISTIC PRESSURE TESTING. RELOADED OR HANDLOADED AMMUNITION, MAY HAVE MANY MANUFACTURING AND QUALITY VARIABLES (SUCH AS THE TYPE AND AMOUNT OF GUN POWDER). CARTRIDGE CASES THAT HAVE BEEN RELOADED AND FIRED MULTIPLE TIMES MAY SUFFER PHYSICAL DAMAGE WHICH COULD SIGNIFICANTLY IMPACT OR REDUCE THE INTEGRITY OF THE CARTRIDGE, POSSIBLY RESULTING IN BULLET SETBACK OR UNSEATING. CASE FAILURE AND INJURY TO THE SHOOTER OR BYSTANDERS AND DAMAGE TO THE FIREARM MAY RESULT WHEN SUCH A ROUND IS FIRED. ANY AMMUNITION THAT IS IMPROPERLY MANUFACTURED OR RELOADED, EVEN IN THE SLIGHTEST DEGREE, MAY FAIL TO FIRE OR MAY GENERATE EXCESSIVE INTERNAL PRESSURES WHICH CAN DAMAGE OR EVEN RUPTURE THE FIREARM, CAUSING PERSONAL INJURY OR DEATH TO THE SHOOTER OR THOSE IN THE IMMEDIATE VICINITY.**

- A firearm and ammunition are a system and must work together. There are different types of ammunition for different types of firearms. Your firearm has been designed for ammunition of a specific type and a specific gauge or caliber. It is important to select the proper ammunition for your firearm.
- Different combinations of bullet velocity, bullet weight and firearm weight can have major impact on felt recoil; a high level of felt recoil can be uncomfortable to some shooters.



**WARNING: NEVER USE AMMUNITION OF THE INCORRECT GAUGE OR CALIBER. USING AMMUNITION OF THE INCORRECT GAUGE OR CALIBER MAY CAUSE DAMAGE TO YOUR FIREARM AND POSSIBLE SERIOUS INJURY TO YOU AND TO OTHERS.**



**WARNING: DEATH, SERIOUS INJURY AND PROPERTY DAMAGE CAN RESULT FROM THE USE OF INCORRECT AMMUNITION OR BORE OBSTRUCTIONS. NEVER USE RELOADED AMMUNITION THAT HAS NOT BEEN SUBJECTED TO INTERNAL BALLISTIC PRESSURE TESTING.**



**WARNING: DISCHARGING FIREARMS IN POORLY VENTILATED AREAS, CLEANING FIREARMS, OR HANDLING AMMUNITION MAY RESULT IN EXPOSURE TO LEAD AND OTHER SUBSTANCES KNOWN TO CAUSE BIRTH DEFECTS, REPRODUCTIVE HARM, AND OTHER SERIOUS PHYSICAL INJURY. HAVE ADEQUATE VENTILATION AT ALL TIMES. WASH HANDS THOROUGHLY AFTER EXPOSURE.**

# MODEL AND FEATURES IDENTIFICATION

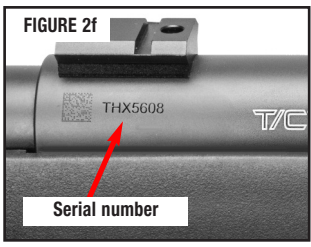
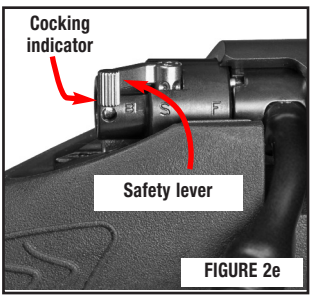
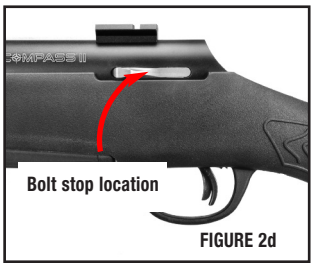
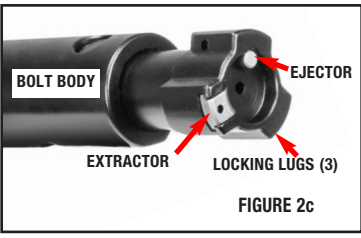
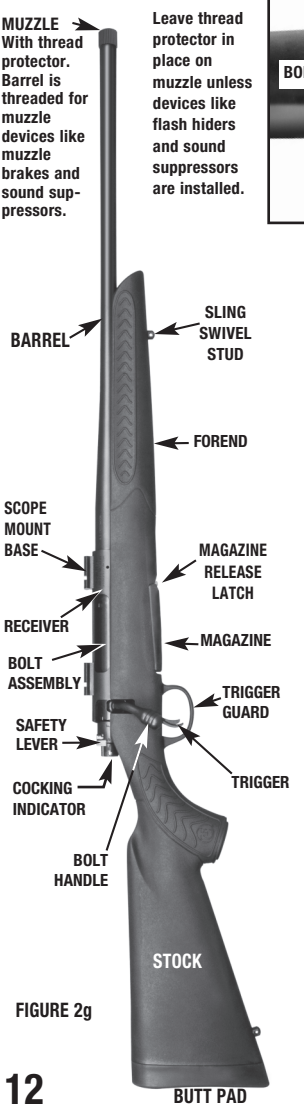
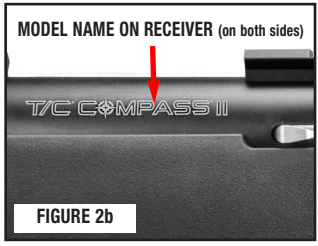
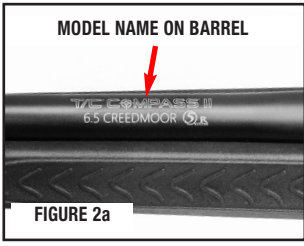

**FIGURE 2g**

# INSPECTING AND INITIAL ASSEMBLY



**WARNING: ALWAYS ENSURE THAT THE FIREARM IS UNLOADED BEFORE INSPECTING, DISASSEMBLING, ASSEMBLING OR CLEANING AND ALWAYS KEEP THE MUZZLE POINTED IN A SAFE DIRECTION.**

- Your Thompson/Center™ COMPASS® II rifle comes completely assembled from the factory except for the bolt, which has been removed for transportation and storage. The bolt assembly is packed separately in the shipping carton.



**WARNING: THE BOLT ASSEMBLY IN THE T/C® COMPASS® II RIFLE IS MATCHED SPECIFICALLY TO THE RECEIVER. BOLT ASSEMBLIES ARE NOT INTER-CHANGEABLE BETWEEN RIFLES. THE LAST FOUR DIGITS OF THE RIFLE'S SERIAL NUMBER ARE MARKED ON THE CORRECT BOLT SHROUD (FIGURE 3) AND BOLT HEAD (FIGURE 4) FOR THAT PARTICULAR RIFLE. NO ATTEMPT SHOULD BE MADE TO USE ANY BOLT IN A RECEIVER THAT DOES NOT HAVE MATCHING NUMBERS AS INJURY AND/OR DEATH TO THE SHOOTER OR BYSTANDERS AND DAMAGE TO PROPERTY MAY RESULT.**

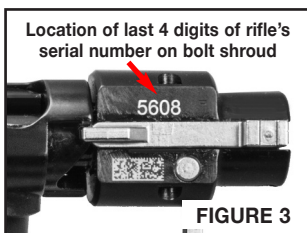

**THE BOLT ASSEMBLY IS PACKAGED SEPARATELY IN THE BOX AS SHIPPED FROM THE FACTORY. BEFORE INSTALLING THE BOLT ASSEMBLY INTO THE RIFLE, CONFIRM THAT THE LAST FOUR DIGITS OF THE RIFLE'S SERIAL NUMBER ALSO APPEAR ON THE BOLT**

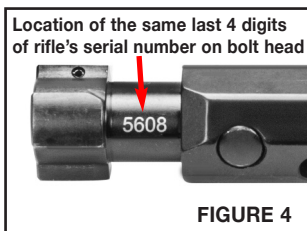

**SHROUD AND BOLT HEAD. IF A RIFLE AND BOLT ASSEMBLY ARE MISMATCHED, THE ENTIRE RIFLE MUST BE RETURNED TO THE FACTORY FOR PROPER FITTING OF A NEW BOLT ASSEMBLY THAT WILL BEAR THE LAST FOUR DIGITS OF THE RIFLE'S SERIAL NUMBER.**

## INSPECTING YOUR RIFLE

- Grasp the rifle, keeping your finger outside the trigger guard and off the trigger. Keep the muzzle pointed in a safe direction.
- Check to be certain that the chamber is empty (FIGURE 5).

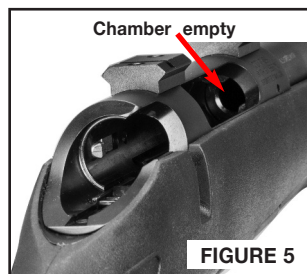

## INSPECTING AND INITIAL ASSEMBLY CONTINUED

- Press and hold the magazine latch to the rear to release the magazine (FIGURE 6).
- With the rifle positioned as shown (FIGURE 7), unlatch the magazine by depressing and holding the latch at the front.
- Tip the front of the magazine down first and remove the magazine from the rifle (FIGURE 8) and ensure that it is empty.
- Remove the COMPASS® II identifier from the barrel (FIGURE 9). The rifle should not be used with the identifier attached.

### INSTALLING THE BOLT ASSEMBLY

**NOTE:** Do not try to move the safety lever with the bolt out of the rifle. The bolt must be in the rifle in the closed position with the firing pin cocked in order to move the safety lever.

- Grasp the bolt by its handle and slide the bolt forward into the receiver about one inch as shown (FIGURE 10).
- Rotate the bolt upward by the handle (FIGURE 11) until the bolt stop engages the bolt stop tracking groove in the bolt itself (FIGURE 12). Sometimes it helps to press the bolt stop in slightly to make it easier to rotate the bolt.

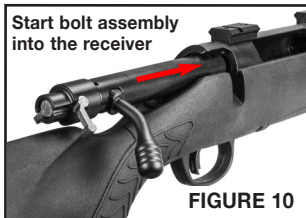
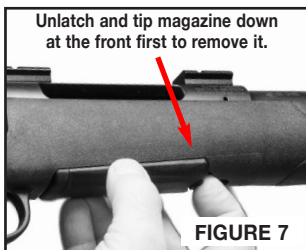
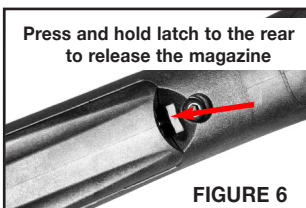

## INSPECTING AND INITIAL ASSEMBLY CONTINUED

- Push the bolt fully forward into the receiver once the bolt stop engages the tracking groove in the bolt (FIGURE 12).

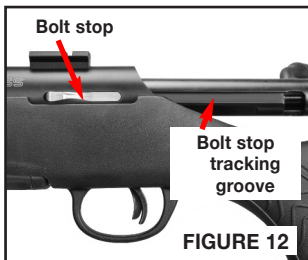

- Close the bolt by turning the bolt handle down (FIGURE 13).

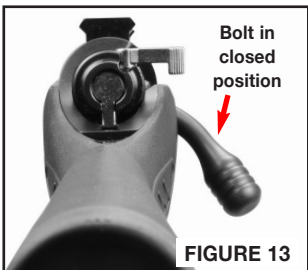

### The Manual Safety Lever

**WARNING: NEVER RELY ON MECHANICAL FEATURES ALONE. ONLY YOUR SAFE FIREARM HANDLING WILL ENSURE THE SAFE USE OF YOUR FIREARM. THIS IS YOUR RESPONSIBILITY.**

- Located on the right side at the rear of the bolt, the manual safety lever has three (3) positions that are set by the user when the bolt is in the closed and cocked position (FIG. 14):  
“BL” (BOLT LOCKED-SAFE)  
“S” SAFE  
“F” FIRE

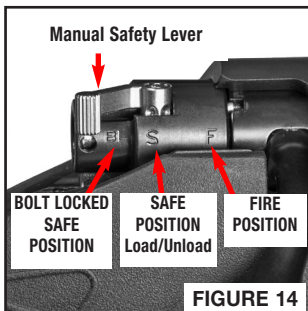

**NOTE:** See page 16 for further details regarding the manual safety lever.

- Cocking indicator is visible near the back of the bolt shroud when the rifle is cocked (FIGURE 15). The indicator is recessed when the firing pin is in the FIRED position (FIGURE 16). The safety lever can only be moved when the rifle is cocked and the bolt is closed. Cock the rifle by lifting the bolt handle fully and then closing it.

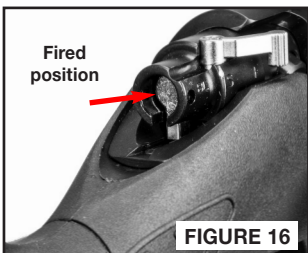
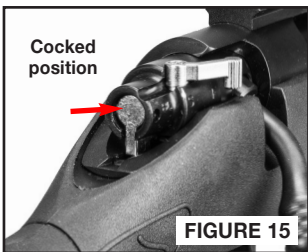

## INSPECTING AND INITIAL ASSEMBLY CONTINUED

- Fully rearward - In the “BL” BOLT LOCKED SAFE position (FIGURE 17). Bolt is locked closed and the rifle is in SAFE mode.
- The middle position - “S” - SAFE LOAD/UNLOAD (FIGURE 18) The rifle is in SAFE mode - but the bolt can be manipulated to load and unload the rifle’s chamber.
- Fully forward in the - “F” FIRE position (FIGURE 19) the rifle can be fired by pulling rearward on the trigger.

 **WARNING: DO NOT ALTER, MODIFY OR REPLACE ANY OF THE PARTS OF YOUR FIREARM UNLESS THIS WORK IS PERFORMED BY A QUALIFIED GUNSMITH USING GENUINE THOMPSON/CENTER™ PARTS. IF YOU DO OTHERWISE, IMPROPER FUNCTIONING MAY OCCUR AND SERIOUS INJURY OR DEATH MAY RESULT.**

 **WARNING: NEVER DO ANYTHING BEYOND WHAT YOU ARE SPECIFICALLY INSTRUCTED TO DO IN THIS MANUAL. NEVER ALTER OR MODIFY THE PARTS IN YOUR FIREARM.**

- Before using your firearm for the first time, it should be cleaned. See the Cleaning section of this manual.

Safety lever fully rearward in the “BOLT LOCKED - SAFE” position

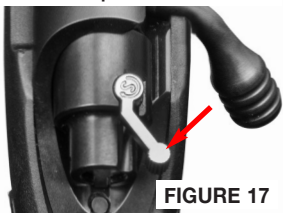

FIGURE 17

Safety lever in the middle “SAFE” LOAD/UNLOAD position

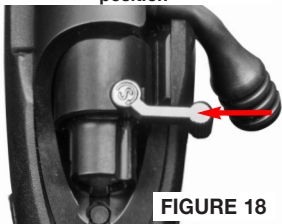

FIGURE 18

Safety lever fully forward in the “FIRE” position

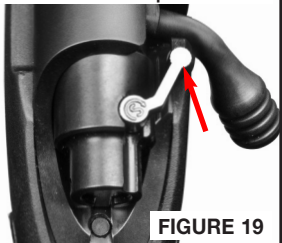

FIGURE 19

## GENERATION II TRIGGER WITH SAFETY LEVER

 **WARNING: ALWAYS KEEP THE MUZZLE POINTED IN A SAFE DIRECTION.**

 **WARNING: ALWAYS ENSURE THAT THE FIREARM IS UNLOADED BEFORE DRY FIRING.**



## GENERATION II TRIGGER WITH SAFETY LEVER CONTINUED

### GENERATION II NON-ADJUSTABLE TRIGGER

**NOTE:** This manual applies only to COMPASS® II rifles with the Generation II non-adjustable trigger with central safety lever (as shown below). There is a separate manual for COMPASS® rifles with the Generation I adjustable trigger which is available for download at [www.tcarms.com](http://www.tcarms.com). Please consult the appropriate manual for the rifle you are using.

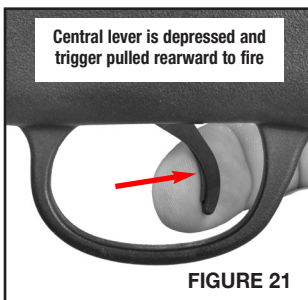
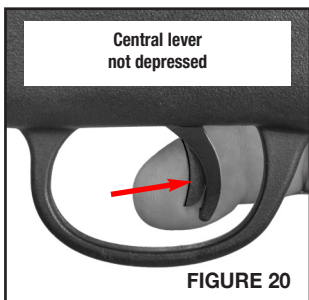

- Located in the center of the trigger, the safety lever must be depressed by the user's finger during the act of firing to allow the trigger to move rearward to fire the rifle (FIGURES 20 and 21).
- The trigger has been set at the factory for optimal weight of pull and overtravel. No further adjustment should be attempted.

## LOADING



**WARNING: ALWAYS POINT THE MUZZLE IN A SAFE DIRECTION.**



**WARNING: NEVER CARRY THIS RIFLE WITH A CARTRIDGE IN THE CHAMBER. FAILURE TO FOLLOW THIS INSTRUCTION CAN LEAD TO PERSONAL INJURY OR DEATH TO YOU OR OTHERS AND DAMAGE TO PROPERTY.**

- Do not load the rifle until you have read and fully understand this manual.
- Do not load the rifle until you are ready to use it.
- Never load your rifle until you are sure of your target, what is beyond it and are fully prepared to fire.
- Open the bolt (FIGURE 22) and draw it fully rearward.

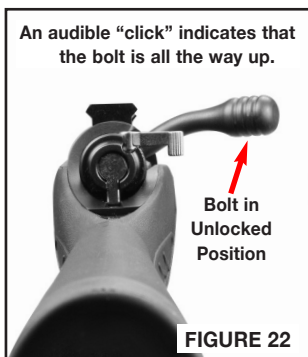

## LOADING CONTINUED

- Press the bolt stop in and remove the bolt from the rifle.
- Inspect the bore for obstructions. Follow the cleaning instructions in this manual to remove any obstructions.
- Reinstall the bolt and close the bolt on an empty chamber.
- Place the safety lever in the “SAFE” LOAD/UNLOAD middle position (FIGURE 23).
- Keep your finger outside the trigger guard and off the trigger, point the muzzle in a safe direction.
- Remove the magazine from the rifle in order to load the cartridges into it.

**NOTE:** The magazines are marked - showing appropriate cartridge usage (FIGURE 24)

- Insert the cartridges into the magazine as shown (FIGURES 25a and 25b). Use the base of the first cartridge loaded into the magazine to gently push the follower (pointed out with red arrow in FIGURE 25a) to the side.

**NOTE:** It helps to press the cartridge(s) that are in the magazine down slightly to aid in starting each subsequent round into the magazine.

- Just prior to firing, with the bolt closed on an empty chamber, insert the loaded magazine into place - tipping the back end in first and then lifting the front until it “clicks” into position (FIGURE 26).

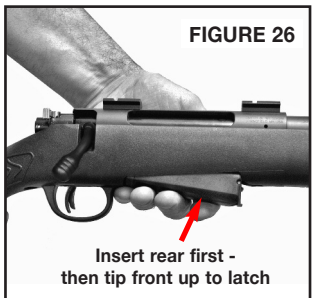
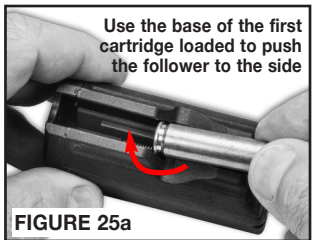
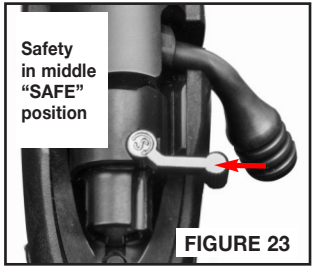

# FIRING



**WARNING: ALWAYS KEEP THE MUZZLE POINTED IN A SAFE DIRECTION.**



**WARNING: WEAR EYE AND HEARING PROTECTION SPECIFIED FOR FIREARM USE EVERY TIME YOU DISCHARGE YOUR FIREARM. MAKE SURE OTHERS IN THE VICINITY OF WHERE YOU WILL BE SHOOTING DO SO AS WELL.**

- With the bolt closed on an empty chamber, make certain that the safety is in the “SAFE” LOAD/UNLOAD middle position (FIGURE 27). You can move the safety lever only when the firing pin is cocked. If the firing pin is in the fired position, lift the bolt handle fully and then return it to the closed position to allow the safety lever to be moved.

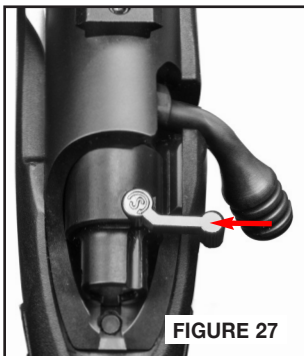

- Open the bolt and draw it fully to the rear, then push forward and close bolt handle (with the bolt handle turned fully down) to strip a round from the magazine and put that round into the chamber.
- Grasp the rifle with one hand on the forend and other hand on the grip with the trigger finger resting along and outside of the trigger guard. Raise the rifle and hold the butt pad firmly against your shoulder.

- Push the safety lever to the fully forward “FIRE” position (FIGURE 28).

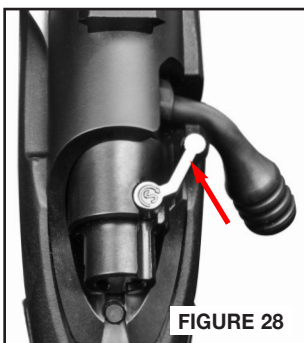

- The rifle will now fire when pressure is applied to the trigger.
- When you are sure of your target and what is beyond it, place your finger on trigger and gently pull the trigger until the rifle fires.

- You may continue to fire the rifle by fully opening and closing the bolt, which will eject the spent case and feed a new cartridge into the rifle, and then pulling the trigger. You may repeat this process until the magazine is empty and the chamber is empty.
- To reload, see the Loading Section.

# CLEARING MISFIRES



**WARNING: IF YOUR FIREARM GIVES ANY INDICATION THAT IT IS NOT PERFORMING PROPERLY OR THE OPERATION OF YOUR FIREARM HAS CHANGED “THE WAY IT FEELS OR SOUNDS”, STOP FIRING. MAKE SURE THE FIREARM IS POINTED IN A SAFE DIRECTION, UNLOAD THE FIREARM AND CALL THOMPSON/CENTER CUSTOMER SUPPORT AT 800-331-0852 EXT 4125 TO HAVE IT INSPECTED BY A FACTORY TECHNICIAN.**

- If a cartridge fails to fire, keep the muzzle pointed in a safe direction and wait 30 seconds before opening the bolt and ejecting the suspect cartridge. Then remove the magazine and make sure that the rifle is unloaded. Dispose of the defective cartridge in a method specifically approved for live round disposal.

## UNLOADING



**WARNING: ALWAYS KEEP THE MUZZLE POINTED IN A SAFE DIRECTION.**

- Open the bolt and ensure that the chamber is empty (FIGURES 29 and 30).

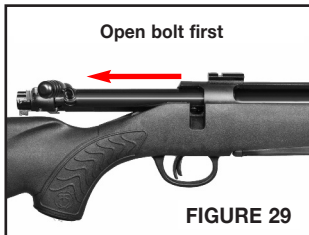

- Press and hold the magazine latch (FIGURE 31) rearward.

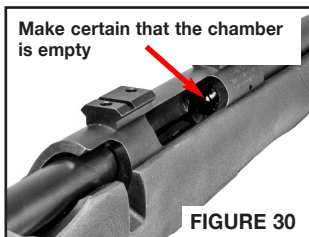

- Remove the magazine from the rifle (FIGURE 32).



## UNLOADING CONTINUED

- Close the bolt on an empty chamber (FIGURE 33).

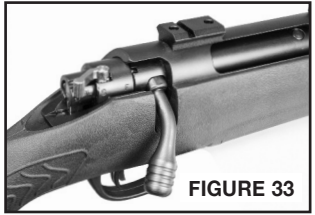

- Set the manual safety lever into the middle "SAFE" LOAD/UNLOAD position as shown (FIGURE 34).

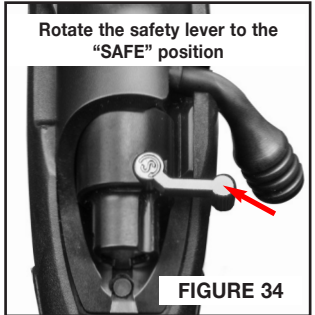

- Remove any cartridges from the magazine by holding the magazine in one hand and pushing the cartridges out with the other (FIGURE 35).



# DISASSEMBLY/FIELD STRIPPING



**WARNING: ALWAYS KEEP THE MUZZLE POINTED IN A SAFE DIRECTION.**



**WARNING: NEVER DO ANYTHING BEYOND WHAT YOU ARE SPECIFICALLY INSTRUCTED TO DO IN THIS MANUAL. NEVER ALTER OR MODIFY THE PARTS IN YOUR FIREARM.**



**WARNING: WEAR SAFETY GLASSES SPECIFIED FOR USE WITH FIREARMS EVERY TIME YOU ASSEMBLE OR DISASSEMBLE YOUR FIREARM.**



**WARNING: DO NOT ALTER, MODIFY OR REPLACE ANY OF THE PARTS OF YOUR FIREARM UNLESS THIS WORK IS PERFORMED BY A QUALIFIED GUNSMITH USING GENUINE THOMPSON/CENTER™ PARTS. IF YOU DO OTHERWISE, IMPROPER FUNCTIONING MAY OCCUR AND SERIOUS INJURY OR DEATH MAY RESULT.**

## REMOVAL OF BOLT

- Lift the bolt handle and draw the bolt fully to the rear (FIG. 36).
- Confirm that the chamber is empty (FIGURE 37).



FIGURE 36

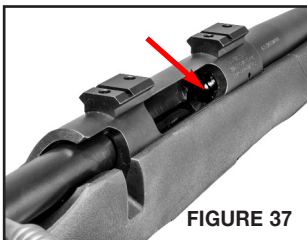

FIGURE 37



FIGURE 38

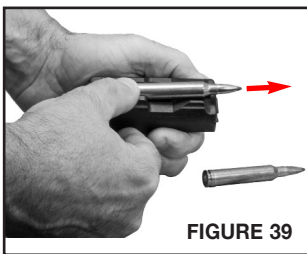

FIGURE 39

- Remove magazine from rifle (FIGURE 38).
- Hold the magazine in one hand and push any cartridges out of the magazine (FIGURE 39).

## DISASSEMBLY / FIELD STRIPPING CONTINUED

- Close the bolt on an empty chamber (FIGURE 40).



- Set the manual safety lever into the middle "SAFE" position as shown (FIGURE 41).



- Open the bolt and draw it fully rearward.

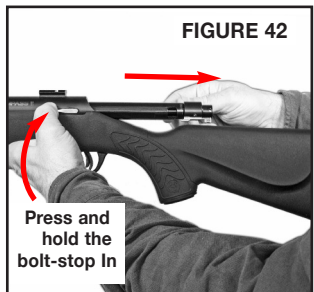

- Press the bolt stop in and hold it as shown (FIGURE 42). Continue to hold the bolt stop depressed while you remove the bolt from the receiver with a gentle pull rearward.

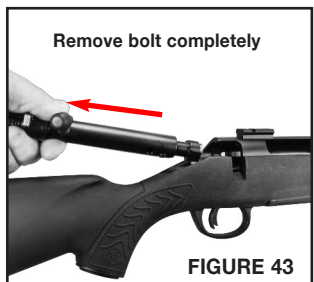

- Withdraw the bolt fully, taking care not to hit the stock - possibly causing cosmetic damage (FIGURE 43).

**NOTE:** Under normal conditions, this is the extent of disassembly that needs to be done for cleaning or storage. For details on disassembling the bolt, see the bolt disassembly instructions in the Cleaning and Maintenance Section of this manual.

# MOUNTING A SCOPE



**WARNING: ALWAYS ENSURE THAT THE FIREARM IS UNLOADED BEFORE INSTALLING A SCOPE OR ANY OTHER ACCESSORIES. FAILURE TO DO THIS CAN CAUSE PERSONAL INJURY OR DEATH TO YOU OR OTHERS.**

We recommend that you have a competent gunsmith install your scope and mount.

The COMPASS® II is factory drilled and tapped for scope mount bases. Weaver®-style bases are included with the rifle. Different scopes have varying lengths of recommended eye relief. You need to choose a combination that allows for adequate clearance between the scope and your eye. Follow the instructions supplied with the scope and rings for proper installation (FIG. 44).

Follow the instructions supplied with the scope and mounts to ensure proper eye relief



FIGURE 44



**WARNING: A SCOPE WHICH IS NOT SECURELY MOUNTED MAY BECOME DETACHED UPON RECOIL OF THE FIREARM. IF IT BECOMES DETACHED, IT MAY FLY BACK AND STRIKE THE SHOOTER OR A BYSTANDER AND CAUSE INJURY. OBSERVE THE CONDITION OF ALL THE SCOPE MOUNT SCREWS AFTER FIRING. IF THE MOUNTING SCREWS SHOW SIGNS OF LOOSENING DO NOT FIRE THE FIREARM AGAIN; TAKE IT TO A QUALIFIED GUNSMITH FOR ASSISTANCE.**



**WARNING: FIRING A SCOPED FIREARM WITH YOUR EYE TOO CLOSE TO THE SCOPE EYE PIECE, FAILING TO HOLD THE FIREARM SECURELY AGAINST RECOIL OR FAILING TO WEAR EYE PROTECTION THAT IS SPECIFIED FOR USE WITH FIREARMS MAY RESULT IN SERIOUS PERSONAL INJURY INCLUDING, BUT NOT LIMITED TO, BLINDNESS.**



---

# CLEANING AND MAINTENANCE

---



**WARNING: ENSURE THAT YOUR FIREARM IS UNLOADED BEFORE BEGINNING TO CLEAN IT. (SEE “INSPECTING YOUR FIREARM” SECTION). ALWAYS FOLLOW THE RULES OF SAFE FIREARM HANDLING.**



**WARNING: WEAR EYE PROTECTION SPECIFIED FOR FIREARM USE EVERY TIME YOU CLEAN OR MAINTAIN YOUR FIREARM.**

- Before using your firearm for the first time, it should be cleaned.
- Your firearm was treated at the factory with either a preservative or oil to protect it against corrosion during shipping and storage.
- Preservative and oil should be wiped from the bore, chamber and exposed areas using a clean swab or patch before using the firearm.

**CAUTION:** Never disassemble your firearm beyond the instructions in the Field Stripping and Inspection sections of this manual.

- Purchase cleaning supplies from your firearms dealer that are specifically designated for your type and caliber of firearm. Many suppliers offer these in kit form for your convenience.
- Follow the instructions provided with your cleaning supplies.

**NOTE:** A basic firearm cleaning kit should include: a brass bore brush and a cleaning jag of appropriate size for the bore being cleaned, high-quality gun cleaning solvent and gun oil/lubricant, cotton cleaning patches and a cleaning rod that is long enough to push the brush and jag completely through the barrel.

- Remove excessive firing residue from the bore and chamber using a properly fitted brass brush dipped in gun cleaning solvent. Finish the bore cleaning process by running a dry cotton cloth patch through the bore to remove residue and solvent.
- Clean the exterior of the firearm using a non-abrasive cleaning cloth.
- After cleaning, lightly coat the metal parts, internal and external with a high quality firearm oil.
- Whenever your firearm has been exposed to sand, dust, extreme humidity, water or other adverse conditions, it must be cleaned and lubricated.

---

## CLEANING AND MAINTENANCE CONTINUED

---



**WARNING: ALWAYS HAVE ADEQUATE VENTILATION. CLEANING FIREARMS IN POORLY VENTILATED AREAS, DISCHARGING FIREARMS, OR HANDLING AMMUNITION MAY RESULT IN EXPOSURE TO LEAD AND OTHER SUBSTANCES KNOWN TO CAUSE BIRTH DEFECTS, REPRODUCTIVE HARM AND OTHER SERIOUS PHYSICAL INJURY. WASH HANDS THOROUGHLY AFTER EXPOSURE.**

**CAUTION:** Always follow the instructions provided with your gun cleaner and gun lubricant.

**CAUTION:** Some cleaners can cause damage to your firearms. You should avoid prolonged solvent immersion and prolonged ultrasonic cleaning of your firearm. Choice of solvent should be restricted to those products specifically developed for firearms maintenance. Damage to a firearm's finish may occur if these cautions are ignored. Ammoniated solvents or other strong alkaline solvents, should not be used on any Thompson/Center™ firearm. Cleaning is essential to ensure the proper functioning of your firearm.

- Your firearm is a precision instrument. To ensure reliable function it is necessary to follow a routine maintenance procedure. After firing your firearm, be sure to unload it following the procedure outlined in the section entitled "Inspecting Your Firearm" before performing any cleaning or maintenance procedure.
- Remove any gun cleaning solution, oil and fingerprints from the outside surfaces of the firearm. (Finger moisture, if left, could start a corrosion process.)



**WARNING: NEVER MANIPULATE, ADJUST OR CHANGE ANY OF THE INTERNAL COMPONENTS OF YOUR FIREARM UNLESS SPECIFICALLY DIRECTED TO DO SO IN THIS MANUAL. IMPROPER MANIPULATION OF ANY INTERNAL COMPONENT MAY AFFECT THE SAFETY AND RELIABILITY OF YOUR FIREARM AND MAY CAUSE SERIOUS INJURY OR DEATH. IT ALSO VOIDS YOUR WARRANTY.**



**WARNING: ANY MAINTENANCE, ADJUSTMENT OR SERVICE NOT SPECIFIED IN THIS MANUAL MAY AFFECT THE SAFETY AND RELIABILITY OF YOUR FIREARM AND MUST BE PERFORMED BY A QUALIFIED GUNSMITH USING GENUINE THOMPSON/CENTER™ PARTS. IF YOU DO OTHERWISE, IMPROPER FUNCTIONING OF YOUR FIREARM MAY OCCUR AND SERIOUS INJURY OR DEATH MAY RESULT.**

- If your firearm will be used in a cold climate, be sure to use a quality gun oil that it will not congeal in cold temperatures, causing the interaction of important parts to be slowed or halted.

## CLEANING AND MAINTENANCE CONTINUED

- Periodically check to verify that the two 5/32" hex head stock bolts at either end of the action are snug (FIGURE 45).

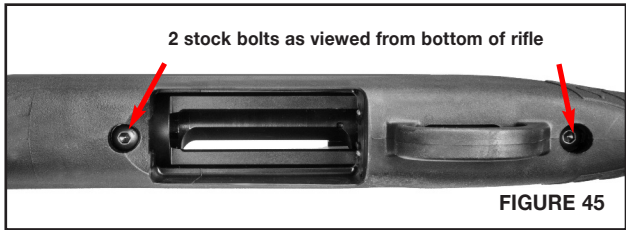

- If you would like to remove the stock from the rifle for more thorough cleaning, follow these instructions while keeping the rifle pointed in a safe direction:

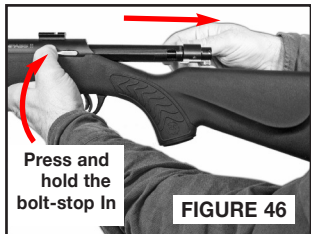

- Open the bolt and draw it fully rearward.

- Remove the magazine from the rifle and set it aside.

- Press and hold the bolt stop and remove the bolt from the rifle (FIGURES 46 and 47). Instructions for further bolt disassembly follow in a later section of this manual.

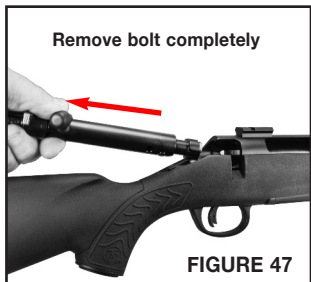

- Remove the 2 stock bolts (FIGURES 48a and 48b) that hold the stock onto the receiver. Use a 5/32" hex wrench.

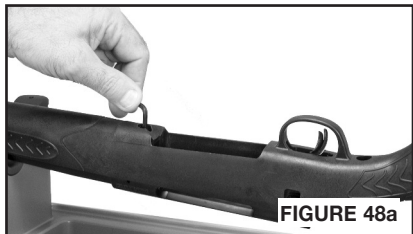

- Separate the stock from the barreled action and set the stock aside.

- Clean the parts as needed.

- Reassemble the rifle as detailed on the following page.



## CLEANING AND MAINTENANCE CONTINUED

- As the rifle is reassembled, make certain the recoil lug is engaged with the stock correctly (FIGURE 49).
- Reassemble the barreled action into the stock. Tighten the two 5/32" hex head bolts at either end of the action (FIGURES 50 and 51) until snug. The bolts are both the same length and can be interchanged.

**NOTE:** Be certain that the two trigger (fire-control) assembly pins are centered side to side (not protruding from either side) in the receiver when reassembling the barreled action into the stock (FIGURE 52). If these pins are too far to the left or right they will interfere with the stock and you will not be able to engage the stock takedown screws.

**WARNING:**  
**INCORRECT ASSEMBLY**  
**MAY RESULT IN DAMAGE TO THE FIREARM AND CREATE AN UNSAFE CONDITION.**

### Dry Firing Note:

Be certain that the chamber is unloaded and the magazine is removed from the rifle. Keep the firearm pointed in a safe direction. The COMPASS® II rifle can be dry fired without damage to the firing pin or other components. To dry fire, cock the rifle by lifting the bolt handle fully and returning it to the closed position and then pulling the trigger - with the safety lever in the FIRE position.

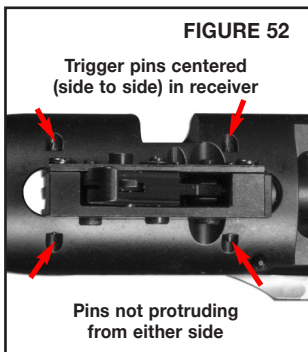
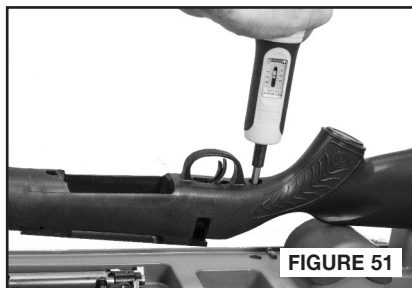
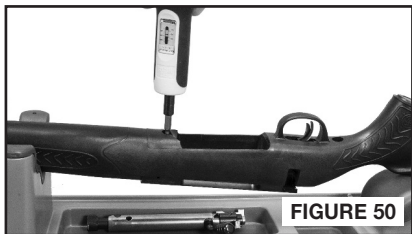

## CLEANING AND MAINTENANCE CONTINUED

### MAINTENANCE BEFORE STORAGE

- When storing, do not encase your firearm in anything that will attract or hold moisture, for example, leather or heavy cloth. Also, do not store guns with a plug inserted in the barrel for this can be a contributing factor to moisture accumulation. If your firearm is to be stored for an extended period, the bore, chamber and internal surfaces should be oiled with a high-quality lubricating oil or preservative intended for firearms. The external parts; receiver, bolt and barrel should be coated with an anti-rust oil. Before using your firearm again, be sure to clean it. Every time you clean your firearm, check it for signs of wear. If wear is noted, do not use the firearm. Return it to Thompson/Center™ for service or have it checked by a qualified gunsmith.

### LUBRICATION POINT

- A single drop of light, non-congealing gun oil can be applied to the sear engagement surface (FIGURE 53a).

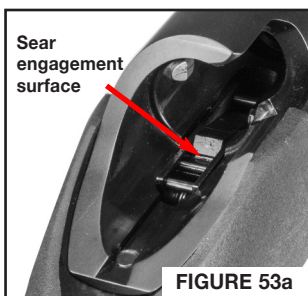

## STOCK SPACER FOR COMPASS® II COMPACT

- The COMPASS® II COMPACT allows the length of pull to be altered by 7/8" (FIGURE 53b).

- Both the standard and extended butt pads are held to the stock by 2 Phillips head screws. Loosen the 2 screws and remove the butt pad. Gather the extra set of screws provided in the box, substitute the other butt pad and tighten screws.

**NOTE:** When inserting a Phillips head screwdriver into the holes of the butt pad, a few drops of silicone lubricant on the screwdriver shaft will keep the butt pad material from breaking away around the screw hole.

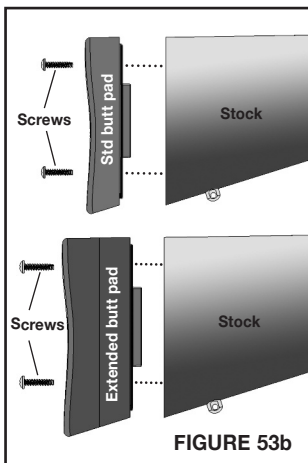



## DETAILED BOLT DISASSEMBLY FOR CLEANING CONTINUED

- Remove the bolt from the rifle.
- When the bolt is removed from the receiver, the firing pin is cocked (FIGURE 57).
- Uncock the firing pin. To do this, grasp the bolt body in one hand and the bolt shroud in the other hand and rotate the bolt shroud to move the firing pin assembly from the cocked position to the uncocked position (FIGURES 58 and 59).
- Press the bolt shroud against a hard surface to relieve spring tension and at the same time - pull the bolt handle clear of the bolt body (FIGURE 60).
- After the bolt handle is pulled free of the bolt body (FIGURE 61) the firing pin assembly can be removed from the bolt body - allowing it to be cleaned and lightly lubricated.

**NOTE:** Some jiggling of the firing pin assembly may be required as you pull on it to allow it to be pulled free of the bolt body.

- After the firing pin assembly is pulled free of the bolt body the bolt head retainer pin and bolt head can be removed from the bolt body - allowing them to be cleaned and lightly lubricated (FIGURE 62).

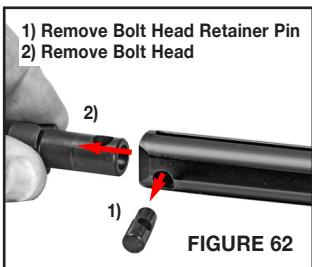
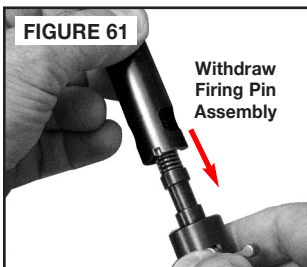
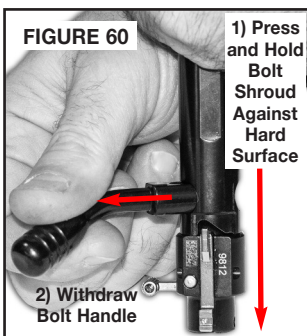
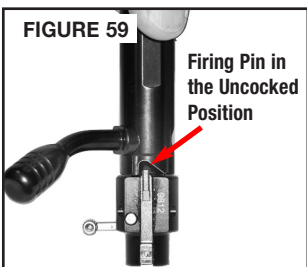

## BOLT REASSEMBLY



**WARNING: THE BOLT ASSEMBLY IN THE COMPASS® II RIFLE IS MATCHED SPECIFICALLY TO THE RECEIVER. BOLT ASSEMBLIES ARE NOT INTERCHANGEABLE BETWEEN RIFLES. THE LAST FOUR DIGITS OF THE RIFLE'S SERIAL NUMBER ARE MARKED ON THE BOLT SHROUD (FIGURE 63) AND BOLT HEAD (FIGURE 64) FOR THAT PARTICULAR RIFLE. NO ATTEMPT SHOULD BE MADE TO USE ANY BOLT IN A RECEIVER THAT DOES NOT HAVE MATCHING NUMBERS AS INJURY AND/OR DEATH TO THE SHOOTER OR BYSTANDERS AND DAMAGE TO PROPERTY MAY RESULT.**

**THE BOLT ASSEMBLY IS PACKAGED SEPARATELY IN THE BOX AS SHIPPED FROM THE FACTORY. BEFORE INSTALLING THE BOLT ASSEMBLY INTO THE RIFLE, CONFIRM THAT THE LAST FOUR DIGITS OF THE RIFLE'S SERIAL NUMBER ALSO APPEAR ON THE BOLT**

**SHROUD AND BOLT HEAD. IF A RIFLE AND BOLT ASSEMBLY ARE MIS-MATCHED, THE ENTIRE RIFLE MUST BE RETURNED TO THE FACTORY FOR PROPER FITTING OF A NEW BOLT ASSEMBLY THAT WILL BEAR THE LAST FOUR DIGITS OF THE RIFLE'S SERIAL NUMBER.**

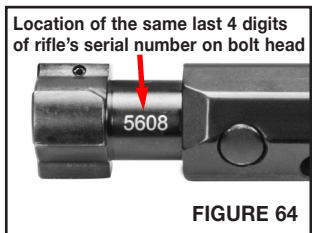
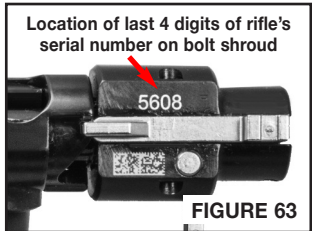

- When reassembling the bolt, put the bolt head and bolt head retaining pin back into the bolt body. The retaining pin will only enter the bolt body and bolt head in one direction - when everything is lined up correctly (FIGURE 65).

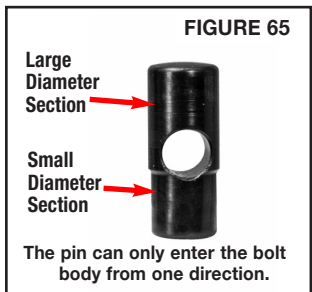

- Return the bolt head into the bolt body (FIGURE 66) and install the bolt head retaining pin.

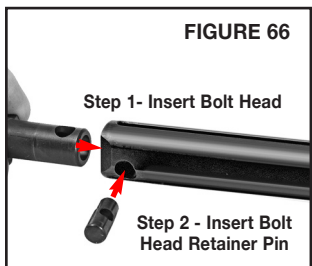



## BOLT REASSEMBLY CONTINUED

- Then, return the firing pin assembly into the bolt body. Keep the firing pin assembly in the uncocked position (FIGURE 67).

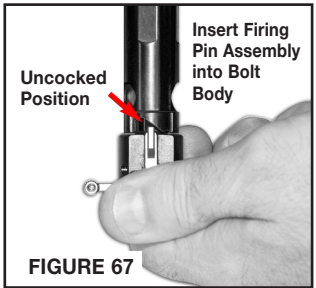

- Press the bolt shroud against a hard surface to compress spring slightly. Insert the bolt handle into the bolt body slot (FIGURE 68).

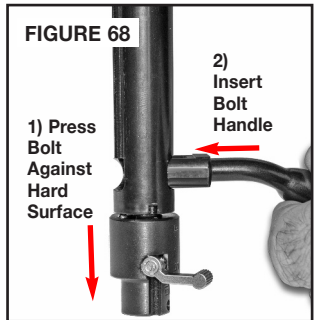

- Pull on the bolt handle to ensure that it is assembled correctly and held securely in place by the cocked firing pin assembly. If the bolt handle comes free when pulled, it was not installed properly, repeat assembly procedure and try to pull the handle out again until it remains in place when pulled.

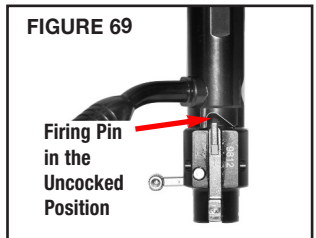

- After the bolt handle is re-installed, the firing pin must now be re-cocked by grasping the bolt body in one hand and turning the bolt shroud with the other hand. An audible “click” indicates that the firing pin is re-cocked (FIGURES 69, 70 and 71).

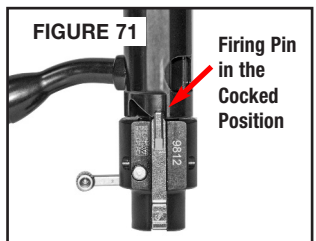
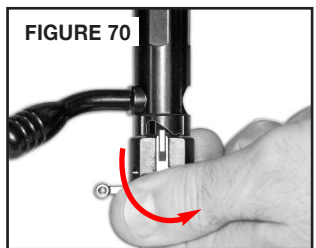

## BOLT REASSEMBLY CONTINUED

**NOTE:** The firing pin must be cocked to allow the bolt to be installed back into the receiver. Failure to re-cock the firing pin before installing the bolt back into the receiver could result in cosmetic damage to the stock as the parts won't be aligned correctly and the stock may interfere.

- Re-install bolt into receiver (FIGURES 72 and 73) and check for proper functioning. Sometimes it helps to press the bolt stop in slightly to make it easier to rotate the bolt into position.

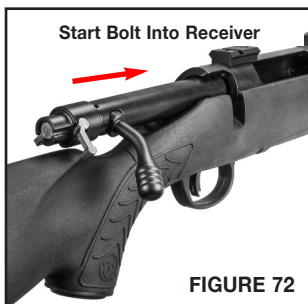

**WARNING: NEVER MANIPULATE, ADJUST OR CHANGE ANY OF THE INTERNAL COMPONENTS OF YOUR FIREARM UNLESS SPECIFICALLY DIRECTED TO DO SO IN THIS MANUAL. IMPROPER MANIPULATION OF ANY INTERNAL COMPONENT MAY AFFECT THE SAFETY AND RELIABILITY OF YOUR FIREARM AND MAY CAUSE SERIOUS INJURY OR DEATH.**



---

# LIMITED LIFETIME WARRANTY

---

This warranty is granted by Smith & Wesson Inc. doing business as Thompson/Center Arms™. This warranty is effective from the date of purchase for the lifetime of the original retail purchaser of any factory finished firearm. In order to be eligible for service under this warranty, the original retail purchaser must return a completed authorized warranty card or register online at <http://www.tcarms.com/warranty-details/registration> within thirty (30) days of purchase of such firearm. With respect to such firearm, this warranty supersedes any and all other warranties.

Thompson/Center Arms™ brand firearms are warranted to be free from defects in material and workmanship. Any such defects of which Smith & Wesson® receives written notice by the original retail purchaser will be remedied without charge within a reasonable time after such notification and delivery of the firearm as provided below.

Warranty claims (in writing) and the firearm or part thereof concerned should be delivered, postage prepaid, to the factory at Smith & Wesson, 2100 Roosevelt Ave., Springfield, MA 01104, Attn: Service Department. In addition, a copy of the bill of sale in the original retail purchaser's name, or, where applicable, a copy of BATFE Form 4473 indicating date of purchase must be included. Please include your physical address and phone number. You must comply with all applicable federal, state and local laws and regulations in the shipment of firearms to Smith & Wesson®.

**NOTE: See the Contact And Shipping section of this manual for further details regarding returns.**

Warranty claims should state the model and, where applicable, the serial number of the firearm concerned and the description of the difficulty experienced. It is recommended that shipments be insured by the owner, since Smith & Wesson® will accept no responsibility for loss or damage in transit. Transportation and insurance charges for return to the owner will be paid by Smith & Wesson® if the claim is covered by this warranty.

If the work required is not covered by our "Limited Lifetime Warranty" you will receive a quotation which must be authorized by you. No actual work will be done without your approval. Return shipments can be shipped via UPS, FedEx or mail at your cost. Repaired product will be shipped back to you via FedEx requiring an adult signature upon receipt.

**UNDER NO CIRCUMSTANCES SHALL SMITH & WESSON® BE RESPONSIBLE FOR INCIDENTAL OR CONSEQUENTIAL DAMAGES WITH RESPECT TO ECONOMIC LOSS, INJURY, DEATH OR PROPERTY DAMAGE, WHETHER AS A RESULT OF BREACH OF THIS WARRANTY, NEGLIGENCE OR OTHERWISE.**

Some states do not allow the exclusion or limitation of incidental or consequential damages, so the above limitation or exclusion may not apply to you.

---

## LIMITED LIFETIME WARRANTY CONTINUED

---

Smith & Wesson® will not be responsible for:

- Defects or malfunctions resulting from careless handling, unauthorized adjustments or modifications made or attempted by anyone other than a qualified gunsmith following authorized procedures, or failure to follow the instructions in Safety & Instruction manual that was provided with the firearm from the factory.
- Use of defective or improper ammunition and/or propellant, corrosion, neglect, abuse, ordinary wear and tear, or unreasonable use.
- Use of replacement parts, including but not limited to barrels and springs, other than factory or authorized parts.
- Criminal misuse, negligence, or use under the influence of drugs or alcohol.

Services that are performed by the Thompson/Center Arms™ Service Department do not void this warranty. This warranty gives you specific legal rights, and you may also have other rights which vary from state to state.

**NOTE:** All liability is excluded in the event that the instructions provided in the Safety and Instruction manual provided with the firearm from the factory are not observed.

---

# BATTERY WARNINGS

---



**WARNING: IF A BATTERY OPERATED ACCESSORY OR ATTACHMENT (I.E. LASER, OPTICAL SIGHT OR FLASH-LIGHT, ETC.) IS SUPPLIED OR USED WITH THIS FIREARM, THE FOLLOWING WARNINGS AND INSTRUCTIONS MUST BE ADHERED TO.**



**WARNING: KEEP BATTERIES AWAY FROM CHILDREN. THERE IS A CHEMICAL BURN HAZARD ASSOCIATED WITH BATTERIES.**



**WARNING: IF A NEW OR USED LITHIUM BUTTON/COIN CELL BATTERY IS SWALLOWED OR ENTERS THE BODY, IT CAN CAUSE SEVERE INTERNAL BURNS AND CAN LEAD TO DEATH IN AS LITTLE AS 2 HOURS. ALWAYS COMPLETELY SECURE THE BATTERY COMPARTMENT. IF THE BATTERY COMPARTMENT DOES NOT CLOSE SECURELY, STOP USING THE PRODUCT, REMOVE THE BATTERIES, AND KEEP IT AWAY FROM CHILDREN. IF YOU THINK BATTERIES MIGHT HAVE BEEN SWALLOWED OR PLACED INSIDE ANY PART OF THE BODY, SEEK IMMEDIATE MEDICAL ATTENTION.**

- When used correctly, batteries provide a safe and dependable source of portable power. However, misuse or abuse may result in leakage, fire, or explosion.
- Batteries can explode or leak and cause burns if installed backwards, disassembled, charged, or exposed to water, fire or high temperature.
- Always take care to install your batteries correctly observing the “+” and “-” marks on the battery and the device.
- Always replace the whole set of batteries at one time, taking care not to mix old and new batteries, or batteries of different types.
- Store unused batteries in their original packaging and away from metal objects that may short-circuit them.
- Remove discharged batteries from equipment promptly to avoid possible damage from leakage.
- Never dispose of batteries in fire. (Failure to observe this precaution may result in an explosion.)
- The batteries are supplied in a charged state and are not designed for recharging. Recharging may cause leakage, fire, or explosion.
- The batteries should be disposed of properly, including keeping them away from children.
- Dispose of used batteries immediately. Even used batteries may cause injury.

---

# CONTACT AND SHIPPING INFORMATION

## FOR OWNERS WITHIN THE UNITED STATES

---

**NOTE:** A Return Merchandise Authorization (**RMA**) is the first step in the process of returning a product in order to receive a repair, replacement or refund.

Please contact the Thompson/Center Customer Service Dept. (e-mail: [tca\\_customerservice@tcarms.com](mailto:tca_customerservice@tcarms.com) or by phone at 800-331-0852 ext. 4125) to obtain authorization to return your firearm so we can process it quickly and efficiently. The RMA number that is supplied by Thompson/Center Arms™ must be displayed on the outside of the returned product's packaging; returns without an RMA number will be routed differently which will result in delayed processing.

The issuance of a Return Merchandise Authorization (**RMA**) allows Thompson/Center Arms™ an opportunity to try to diagnose and correct a customer's concerns with the product (such as ammunition problems) before it is returned. Accordingly, please contact us before returning your Thompson/Center™ firearm.

**Shipping Address:** Thompson/Center Arms  
2100 Roosevelt Avenue  
Springfield, MA 01104

Should your Thompson/Center™ firearm require service, it should be returned to the Thompson/Center™ factory.

- Call toll free 800-331-0852 or e-mail the Customer Service Dept. for authorization and shipping instructions.
- Ensure that the magazine and chamber are unloaded.
- **Do not attempt to ship a firearm via US Postal Service; only federally licensed dealers may ship a firearm by US Postal Service.**
- **DO NOT SHIP ANY AMMUNITION.**
- Enclose a letter which includes your full name and address (no P.O. Boxes, please), daytime telephone number, e-mail address, the serial number of the firearm, and details of the problem experienced (stating the brand and type of ammunition used when the problem occurred) or work desired.
- Record the serial number before shipping, in case you wish to check on the repair status of your firearm.
- Please remove all custom parts and accessories, such as stocks, special sights and scopes, or slings from your firearm before returning.

---

## CONTACT AND SHIPPING INFORMATION CONTINUED

---

- Place the firearm in its original case or in a similarly secure container and pack it securely.
- The package must NOT bear any markings which indicate the identity of the contents.
- It is most important that you comply with federal, state, and local laws and regulations. The following guidelines are meant to help, but you must seek assistance from the appropriate authorities if necessary.
- If your firearm must be replaced, it may be necessary to ship the replacement to a dealer rather than directly to you. You may be requested to furnish a signed FFL (Federal Firearms License) from your dealer in such an instance.
- Warranty repair work will begin upon receipt and examination of the firearm. In the case of repairs or work not covered by the warranty, a quotation covering the cost of the work plus shipping charges will be sent to you. Repairs or modification will be scheduled upon receipt of payment.



**WARNING: YOU MAY PURCHASE ACCESSORIES FOR YOUR THOMPSON/CENTER™ FIREARM. YOU MUST HAVE SOME OF THESE PARTS INSTALLED BY A GUNSMITH QUALIFIED TO PERFORM SERVICE ON THOMPSON/CENTER™ FIREARMS. NEVER ATTEMPT TO MODIFY YOUR FIREARM OR INSTALL REPLACEMENT PARTS IN YOUR FIREARM. ALWAYS USE A QUALIFIED THOMPSON/CENTER™ GUNSMITH EVEN IF THE REPAIR SEEMS SIMPLE.**

---

# PATENT INFO

---

- This product may be covered by one or more patents. Visit [www.tcarms.com](http://www.tcarms.com) for virtual patent information.

---

## ADDRESSES AND PHONE NUMBERS

---

**Thompson/Center Mailing Address:  
(for questions and comments)**

Thompson/Center Arms  
2100 Roosevelt Avenue  
Springfield, MA 01104

**Thompson/Center Shipping Address:  
(for repairs or warranty work)**

Thompson/Center Arms ATTN: Service Department  
2100 Roosevelt Avenue  
Springfield, MA 01104

**Thompson/Center Web Address:** [www.tcarms.com](http://www.tcarms.com)

**Thompson/Center Customer Service Phone:**

Toll Free 800-331-0852 ext.4125

**Thompson/Center Customer Service E-mail:**

[tca\\_customerservice@tcarms.com](mailto:tca_customerservice@tcarms.com)



3012691