

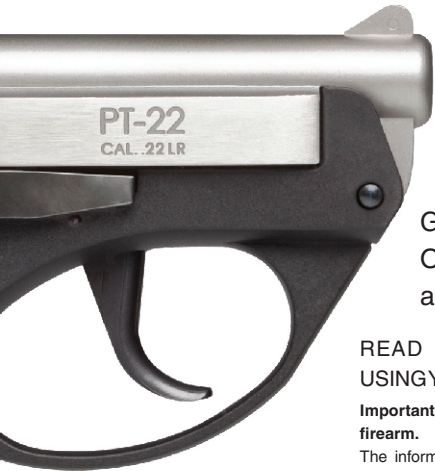

TAURUS[®]



PT22/25 INSTRUCTION MANUAL

General Safety,
Operating Instructions
and Limited Warranty

**READ CAREFULLY BEFORE
USING YOUR FIREARM**

**Important: Keep this manual with your
firearm.**

The information contained in this manual is useful, both for beginners and experienced shooters. In addition to important information about functioning, cleaning and care of the gun, the manual contains instructions that may be very helpful in shooting properly. The most important rule of safe gun handling is always keep the muzzle pointed in a safe direction!



ATTENTION

THIS BOOKLET

The safety warnings in this booklet are important. By understanding the dangers inherent in the use of any firearm, and by taking the precautions described herein, you can enjoy complete safety in the use of your Taurus firearm. Failure to heed any of these warnings may result in serious injury to you or others, as well as severe damage to the firearm or other property.

CONTENTS

1. Safety precautions	Page 04
2. Get to know your pistol	Page 12
Specifications	Page 12
Safety Devices	Page 13
Taurus Security System	Page 15
3. Ammunition	Page 16
4. Operating Instructions	Page 20
5. Disassembly/Reassembly	Page 24
Disassembly	Page 24
Reassembly	Page 25
6. Care and maintenance	Page 26
7. Exploded View	Page 28
Parts List	Page 29
8. Taurus Service Policy	Page 32
9. Taurus Limited Warranty	Page 33



1. SAFETY PRECAUTIONS

PISTOLS are classified as FIREARMS or DANGEROUS WEAPONS and are sold by us with the specific understanding that we are not responsible in any manner whatsoever for their improper or negligent handling or resale under local laws and regulations.

Taurus shall not be responsible in any manner whatsoever for malfunctioning of the firearm, or for physical injury or property damage, resulting in whole or in part from (1) criminal or negligent discharge, (2) improper or careless handling, (3) unauthorized modifications, (4) defective, improper hand-loaded, or reloaded ammunition, (5) neglect, or (6) other influences beyond our direct and immediate control. This limitation applies regardless of whether liability is asserted on the basis of contract, negligence or strict liability (including any failure to warn). Under no circumstance shall Taurus be liable for incidental or consequential damages, such as loss of use of property, commercial loss and loss of earnings or profits.

SAFETY WARNINGS

NOT JUST FOR BEGINNERS

Regardless of your familiarity or experience with firearms, you need to study this manual.

The safe handling of firearms requires specialized training, discipline and caution. Firearms, by their nature and intended function, are deadly instruments. Accidental death or serious injury can result if they are handled improperly or carelessly.

Firearms rarely cause accidents. Firearms accidents almost always are caused by a failure to obey the basic rules of gun safety. Unfortunately, experienced shooters seem to violate these rules as frequently as beginners. Thus the basics of safe firearms handling cannot be repeated too often. Read, re-read and practice the basic principles of firearms safety until they become second nature: habits that you don't forget. If you have any question about your knowledge or ability to use this or any other firearm with complete safety you should seek supervised instruction. Personalized instruction is often available from firearms dealers, gun clubs, state hunter safety programs or police departments in the United States. If none of these sources is accessible, write to the National Rifle Association, 11250 Waples Mill Road, Fairfax, VA 22030 or at www.nra.org. **THEY WILL ASSIST YOU.**

A PERSON WITH A FIREARM IN HIS POSSESSION HAS A FULL-TIME RESPONSIBILITY. HE MUST KNOW HOW TO KEEP AND USE HIS FIREARM SAFELY, AND THEN MUST ALWAYS TAKE THE PRECAUTIONS NECESSARY -ALL OF THEM. HE CANNOT GUESS; HE CANNOT FORGET. THIS RESPONSIBILITY IS HIS ALONE. IT CANNOT BE PASSED OFF TO SOMEONE ELSE. REMEMBER: NO FIREARM CAN BE MADE ACCIDENT-PROOF. A FIREARM IS JUST A MACHINE, WITH NO JUDGEMENT OF ITS OWN. IT RESPONDS TO YOUR ACTIONS, WHETHER WISE OR FOOLISH. THE ONLY TRULY EFFECTIVE SAFETY DEVICE IS THE MIND OF A CAUTIOUS SHOOTER WHO NEVER FORGETS THAT A MOMENT'S CARELESSNESS CAN PRODUCE PERMANENT TRAGEDY.

Firearms are not all alike

Many makes and models of firearms might LOOK nearly the same. However, they differ widely in design and operation, and in the location and function of various controls.

Study this manual thoroughly. Educate yourself on the characteristics and operation of your particular firearm before attempting to handle it. Do not permit others to handle it - unless they also have done so.

You should have an instruction manual for every firearm you own. If you do not, write the manufacturer and obtain one. Most manufacturers will gladly send you one free. If for any reason a manual is not available, visit your public library. Many books have been published which contain detailed information on obsolete or discontinued firearms.

You also may access the Taurus web site at taurususa.com to view and print manuals.

Your knowledge can prevent injuries.

Taurus firearms are designed and made to offer maximum safety when correctly used. However, as with any other weapon, it is not foolproof, and may become very dangerous if the next basic recommendations are not RIGIDLY observed:

ATTENTION

NOTICE: Get instruction from a competent firearms instructor before using any firearm.

NOTICE: Never cock the firearm until you are ready to shoot.

DANGER: Never, never-ever point any firearm, loaded or unloaded, at anything you do not intend to shoot.

DANGER: Load and unload with the muzzle pointed in a safe direction.

DANGER: When receiving a firearm always check that it is unloaded (remove magazine and open slide to check if chamber is empty), even if you saw it done previously.

DANGER: Never put your hand over the muzzle of a firearm.

DANGER: Check ammunition to be sure it is the right size and caliber, and that it is not dented.

DANGER: WHILE HANDLING ANY FIREARM, NEVER ALLOW IT TO POINT AT ANY PART OF YOUR BODY OR AT ANOTHER PERSON. NO HARM SHOULD RESULT IF YOU OBEY THIS RULE, EVEN IF AN ACCIDENTAL DISCHARGE OCCURS.

DANGER: Don't try to change your firearm's trigger pull, because alteration of trigger pull usually affects sear engagement and may cause accidental discharge.

DANGER: Never engage a gun lock on a loaded firearm.

DANGER: This product is not intended for use by criminals, for use in the commission of crimes or for any other wrongful purpose. Such uses constitute a misuse of the product and have a high likelihood of serious bodily injury or death for the criminal, the wrongdoer, law enforcement officers and/or innocent bystanders.

CAUTION: If there is any reason to suspect that a bullet is obstructing the barrel, immediately unload the firearm and look through the bore. It is not sufficient to merely look in the chamber.

WARNING: Keep your finger off the trigger until you are actually aiming at the target ready to shoot.

WARNING: Be certain the firearm is unloaded before cleaning.

WARNING: Always empty firearms before entering a place where there are people.

WARNING: Don't test the safety by pulling the trigger while the safety is on unless you are absolutely sure the firearm is empty and you are pointing the muzzle away from everyone, including yourself, and in a safe direction.

WARNING: Never pull a firearm towards you by the muzzle. Don't climb a tree or cross a fence with a loaded firearm.

WARNING: Never carry any firearm in your pocket, purse or waist-band. Use a pistol case or proper holster with safety flap or strap.

WARNING: Old or reloaded ammunition may be dangerous. We recommend against using it.

WARNING: Always treat every firearm as if it were loaded.

WARNING: Do not shoot or handle firearms after consuming beer, wine, other alcoholic beverages, any medications or other drugs that may affect your ability and judgment.

SAFETY FIRST: Never leave a loaded firearm unattended.

SAFETY FIRST: Store firearms and ammunition separately beyond the reach of children.

SAFETY FIRST: Be sure of your target and backstop before you shoot.

SAFETY FIRST: If a firearm fails to fire when the trigger is pulled, keep it pointed at the target for at least 30 seconds. Sometimes slow primer ignition will cause a "hang" fire and the cartridge will go off after a short pause.

SAFETY FIRST: Never shoot at hard flat surfaces or water. Bullet may ricochet.

SAFETY FIRST: Use a proper bench or support and aim the gun only if you intend to shoot.

SAFETY FIRST: Dry firing is bad for this firearm, whether the hammer block is engaged or not.

SAFETY FIRST: Treat this firearm as a precision instrument.

SAFETY FIRST: Write to us concerning any items or circumstances which might relate to your safety and the operation of our products.

SAFETY FIRST: Use a proper holster and draw only if you intend to shoot.

SAFETY FIRST: The safety is only a mechanical device, not a substitute for common sense.

WARNING

Taurus Pistols were manufactured to perform properly with the original parts as designed. It is your duty to make sure any parts you buy are installed correctly and that neither replacements nor originals are altered or changed. Your firearm is a simple tool but it has many parts that must relate correctly to other parts. Putting a firearm together with wrong or modified parts can result in a damaged firearm, danger and injury or death to you and others through malfunction. Always have a qualified gunsmith work on your firearm.

DANGER

THIS PISTOL IS CAPABLE OF FIRING WITH MAGAZINE REMOVED. INJURY OR DEATH MAY RESULT. NEVER POINT A LOADED PISTOL AT ANYONE OR ANYTHING YOU DO NOT INTEND TO SHOOT.

WARNING

To prevent injury or death, it is imperative that you must keep your firearm unloaded, uncocked and securely locked, with ammunition in a separate location. In addition, take any other reasonable steps to limit the possibility of theft, crime, accident or suicide.

LOADING

- 1. DANGER:** Always make sure the muzzle is pointed in a safe direction.
- 2. SAFETY FIRST:** Never attempt to load or unload any firearm inside a vehicle, building or other confined space (except a properly constructed shooting range). Enclosed areas frequently do not offer a completely safe direction to point the firearm; if an accidental discharge occurs, there is a great risk of injury or property damage.
- 3. SAFETY FIRST:** Before loading, always clean all grease and oil from the bore and chamber, and check to be certain that no obstruction is in the barrel. Any foreign matter in the barrel could result in a bulged or burst barrel or other damage to the firearm, and could cause serious injury to the shooter or the others.

POSITION FOR TARGET SHOOTING

Take such stance that your body faces the target at a 90 degree angle. Keep your feet 1 ft. to 1-1/2 ft. apart. Raise your arm so that it lines up naturally with the target. Your head should be turned as needed, so as to have a good sight picture. When you are in a correct position, aim the firearm and squeeze the trigger.

AIMING

Align the rear and front sights carefully. The top of the front sight must be leveled with the top of the rear sight and set in the middle of the notch.

The bullseye should rest on the top of the sights.

SQUEEZE OF THE TRIGGER

Squeeze the trigger carefully with index-finger, keeping sight aligned with the target. If the trigger is jerked, the target will possibly be missed due to the movement of the firearm. The pressure must be applied between the tip and the first joint of the finger. Press slowly and carefully. More speed will be gained with practice.

FIRING

1. DANGER: Keep the muzzle pointed in a safe direction and your finger away from the trigger when cocking any firearm.

2. WARNING: Never carry, handle or leave unattended any firearm which is cocked and ready-to-fire. When cocked, it will fire from slight pressure on the trigger. An accidental discharge could easily result if you fall or drop the firearm, or if the firearm is struck or disturbed by someone or something.

3. WARNING: Never fire any semi-automatic firearm with your finger, hand, face, or other part of your body over or adjacent to the ejection port, or in any position where you may be struck by reciprocating movement of the slide (or bolt). Both the ejection of the empty cartridge cases and the movement of the slide (or bolt) are part of the normal operating cycle of semi-automatic firearms, and pose no safety hazard to the shooter if the firearm is held in a normal grip and fired at arm's length (in the case of a handgun) as intended by its design.

4. CAUTION: Never allow other persons to stand beside you where they might be struck by an ejected cartridge case. The case is hot, and may be ejected with sufficient force to cause a burn, or cut, or injury to an unprotected eye. Make certain there is a clear, unobstructed path for safe ejection of the fired case. Remember, the case may bounce off a hard object nearby and strike you or someone else.

5. DANGER: If while shooting, your firearm develops ANY mechanical malfunction or binding, or "spits" powder, gas, or if a cartridge primer is punctured or a cartridge case is bulged or ruptured, or if the report on firing does not sound quite right, STOP SHOOTING IMMEDIATELY. It may be dangerous to continue. UNLOAD THE FIREARM. DO NOT try "one more shot". Take the firearm and ammunition to a gunsmith for examination.

6. SAFETY FIRST: While shooting any semi-automatic firearm, an unfired cartridge case may occasionally become jammed between the slide (or bolt) and the barrel. Clear the jam as follows, WHILE KEEPING THE MUZZLE POINTED IN A SAFE DIRECTION: remove the magazine, then pull back the slide (or bolt) and hold or lock it to the rear. The jammed cartridge or case now can be removed by shaking it out or by picking it out.

SEMI-AUTOMATIC PISTOLS

1. SAFETY FIRST: Risk of an accident is greatly increased when any semi-automatic pistol, no matter how safely designed is carried with a cartridge in the chamber.

WARNING: THIS PRACTICE IS NOT RECOMMENDED AND MAYBE JUSTIFIED ONLY IN CIRCUMSTANCE OF CLEAR AND PRESENT DANGER, WHEN THE PISTOL MAY IMMEDIATELY HAVE TO BE USED IN SELF DEFENSE. By far the safest procedure when carrying a loaded pistol is to leave the chamber empty.

2. SAFETY FIRST: If you must carry a Taurus semi-automatic pistol with a cartridge in the chamber, ALWAYS place safety in “ON” position until you are ready to shoot and the firearm is pointed at the target.

3. SAFETY FIRST: ALWAYS point the muzzle in a SAFE DIRECTION when manually operating the slide to load the first cartridge from the magazine into the chamber. Malfunctions which allow the pistol to fire without the trigger being pulled when the slide snaps closed are rare but can happen. Always grip the slide so that your fingers, hand, elbow, and other parts of your body are BEHIND the pistol and your finger is off the trigger and well clear of the trigger guard.

4. SAFETY FIRST: These pistols are designed as a “double action only” firearm. This means that the pistol can only be fired by pulling the trigger through. This pistol cannot be cocked i.e. hammer pulled back into a locked (cocked) position. Each shot must be accomplished by pulling the trigger through from its forward position all the way to the rear most position in the trigger guard.

2. GET TO KNOW YOUR PISTOL



*Indicative view

Model	22PLY	25PLY	22	25
Caliber	.22 LR	.25 ACP	.22 LR	.25 ACP
Firing Mechanism	Hammer			
Action	DAO			
Capacity	8+1	9+1	8+1	9+1
Barrel length	2.33"		2-3/4"	
Weight	11.27 oz	11.39 oz	12.66 oz	12.93 oz
Sights	Front: Fixed Rear: Fixed			
Safety Devices	Manual Safety			
Grip	Polymer		Checked Wood, Pearl, Rosewood	
Finish	Blue or Stainless		Blue	
Remarks	Redesigned grip		Golden accents (optional)	

3. SAFETY DEVICES

DANGER

USE OF SAFETY

1. Your firearm comes equipped with an effective, well-designed safety device. **HOWEVER, NEVER RELY COMPLETELY ON ANY SAFETY MECHANISM.** The best safety mechanism is your own common sense: **USE IT!** Always handle your firearm as though you expect the safety **NOT** to work.
2. While handling any firearm, **NEVER ALLOW IT TO POINT AT** any part of your body or at another person. No harm will result if you obey this rule, even if an accidental discharge occurs.
3. Leave the safety “ON” until you are ready to shoot and the firearm is pointed at the target.
4. **ALWAYS** keep your finger **OFF** the **TRIGGER** and point the muzzle in a safe direction when turning the safety “on” or “off”.
5. When applying the safety, be certain to move it **FULLY** into position. On some firearms a red warning dot is located beside the safety; when the safety is fully “on”, the red dot should be completely covered. Always remember, **“HALF-SAFE” IS NOT SAFE.**
6. **NEVER** carry any firearm with a cartridge in the chamber without placing the safety “on” (the only exceptions are double-action revolvers and some double-action pistols which have automatic internal safeties and which are not equipped with manual safeties).
7. For maximum safety never carry a firearm with a cartridge in the chamber.

WARNING

NEVER RELY COMPLETELY ON ANY SAFETY MECHANISM. It is **NOT** a substitute for cautious firearm handling. **NO** safety, however positive or well-designed, should be totally trusted. Like all mechanical devices, the safety is subject to breakage or malfunction and can be adversely affected by wear, abuse, dirt, corrosion, incorrect assembly, improper adjustment or repair, or lack of maintenance. Moreover, there is no such thing as a safety which is “childproof” or which can completely prevent accidental discharge from improper usage, carelessness, or “horseplay”.

Your pistol is manufactured with the following described safety devices. REMEMBER! Mechanical safety devices are not a substitute for safe firearm handling practices.

1. This pistol is designed so that it can only be fired by pulling the trigger through its full range. It cannot be cocked and then discharged by pulling the trigger with lighter pressure.
2. The manual safety is designed to be “ON SAFE” when pushed UP FULLY, covering the red dot. In this position, the trigger cannot be pulled or the slide pulled back.
3. This pistol contains a magazine disconnect. The pistol can be fired and the slide pulled to the rear only when the magazine is inserted in the butt of the pistol.

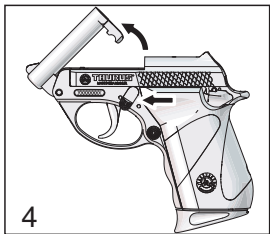

4. A tip up barrel is part of the design of this pistol. This allows the shooter to determine if a round is in the chamber or to load the chamber. Tipping up the barrel is accomplished by pushing forward on the barrel release lever.

TAURUS SECURITY SYSTEM®

ENGAGEMENT (SECURE)

Insert the key into the mechanism and turn clockwise until a click is felt or heard. The mechanism now partially protrudes above the surface of the backstrap of the grip. The action is locked in place and cannot function.

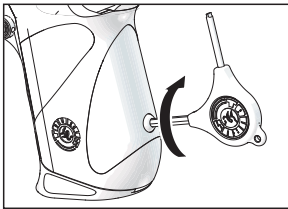

DISENGAGEMENT (READY-TO-FIRE)

To place the pistol in a firing condition, insert the key into the mechanism and turn it counterclockwise. The mechanism is now virtually flush with the backstrap of the grip. The pistol can now be fired.

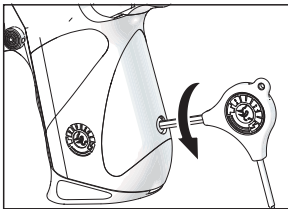

WARNING:

Securing your firearm may inhibit access to it in a defense situation and result in injury or death.

WARNING:

Failure to properly secure a firearm may result in injury or death.

CAUTION:

Never engage the Taurus Security System on your Taurus Pistol with the slide in the open (rearward) position or with the barrel tipped up/open. This will result in permanent damage to your firearm.

3. AMMUNITION

3.1 Use only high quality, original, factory-manufactured ammunition. Do not use cartridges that are dirty, wet, corroded, bent or damaged. Do not oil cartridges. Lubricant or other foreign matter on cartridges can cause potentially dangerous ammunition malfunctions. Use only ammunition of the caliber for which your firearm is chambered. The proper caliber is permanently engraved on your firearm; never attempt to use ammunition of any other caliber.

3.2 The use of reloaded (remanufactured) hand-loaded, or other non-standard ammunition voids all warranties. Improperly loaded ammunition can be extremely dangerous. Severe damage to the firearm and serious injury to the shooter or to others may result. Always use ammunition that complies with the industry performance standards established by the Sporting Arms and Ammunition Manufacturers Institute, Inc., of the United States, (SAAMI) or the equivalent from other countries.

3.3 Firearms may be severely damaged and serious injury to the shooter or to others may result from any condition causing excessive pressure inside the chamber or barrel during firing. Excessive pressure can be caused by obstructions in the barrel, propellant powder overload, or by the use of incorrect cartridges or defectively assembled cartridges. In addition, the use of a dirty, corroded, or damaged cartridge can lead to a burst cartridge case and consequent damage to the firearm and personal injury from the sudden escape of high-pressure propellant gas within the firearm's mechanism.

3.4 Immediately stop shooting and check the barrel for a possible obstruction whenever:

- You have difficulty in, or feel unusual resistance in, chambering a cartridge;
- A cartridge misfires (does not go off);
- The mechanism fails to extract a fired cartridge case;
- Unburned grains of propellant powder are discovered spilled in mechanism;
- A shot sounds weak or abnormal.

In such cases it is possible that a bullet is lodged part way down the barrel.

Firing a subsequent bullet into the obstructed barrel can wreck the firearm and cause serious injury to the shooter or to bystanders.

3.5 Bullets can become lodged in the barrel.

-If the cartridge has been improperly loaded without propellant powder, or if the powder fails to ignite (ignition of the cartridge primer alone will push the bullet out the cartridge case, but usually

does not generate sufficient energy to expel the bullet completely from the barrel).

-If the bullet is not properly seated tightly in the cartridge case. When such a cartridge is extracted from the chamber without being fired, the bullet may be left behind in the bore at the point where the rifling begins. Subsequent chambering of another cartridge may push the first bullet further into the bore.

3.6 If there is any reason to suspect that a bullet is obstructing the barrel, immediately unload the firearm and look through the bore. It is not sufficient to merely look in the chamber. A bullet may be lodged some distance down the barrel where it can not easily be seen.

IF A BULLET IS IN THE BORE, DO NOT ATTEMPT TO SHOOT IT OUT BY USING ANOTHER CARTRIDGE, OR BY BLOWING IT OUT WITH A BLANK OR ONE FROM WHICH THE BULLET HAS BEEN REMOVED. SUCH TECHNIQUES CAN GENERATE EXCESSIVE PRESSURE, WRECK THE FIREARM AND CAUSE SERIOUS PERSONAL INJURY.

If the bullet can be removed with a cleaning rod, clean any unburned powder grains from the bore, chamber, and mechanism before resuming shooting. If the bullet cannot be dislodged by tapping it with a cleaning rod, take the firearm to a gunsmith.

Dirt, corrosion, or other foreign matter on a cartridge can impede complete chambering and may cause the cartridge case to burst upon firing. The same is true of cartridges which are damaged or deformed.

3.7 Do not oil cartridges, and be sure to wipe the chamber clean of any oil or preservative before commencing to shoot. Oil interferes with the friction between cartridge case and chamber wall that is necessary for safe functioning, and subjects the firearm to stress similar to that imposed by excessive pressure.

3.8 Use lubricants sparingly on the moving parts of your firearm. Avoid excessive spraying of any aerosol firearm care product especially where it may get on ammunition. All lubricants and aerosol spray, lubricants in particular, can penetrate cartridge primers and cause misfires. Some highly penetrative lubricants can also migrate inside cartridge cases and cause deterioration of the propellant powder; on firing, the powder may not ignite. If only the primer ignites, there is danger that the bullet may become lodged in the barrel.

WARNING concerning ammunition marked “+P” and “+P+”. Recently there have been many developments by ammunition manufacturers and reloaders, not all of them good. It seems some ammunition manufacturers and reloaders are in a horsepower race to see who can develop the most case pressure and muzzle velocity with little regard for practicality or safety. Some of these loads exceed common sense and can virtually tear metal apart. Taurus Firearms rated for “+P” ammunition are rated for Sporting Arms and Ammunition Manufacturers Institute (SAAMI) compliant “+P” ammunition. **SAAMI does not recognize any “+P+” ammunition at all. It is DANGEROUS to fire “+P+” ammunition in any Taurus firearm and if you do so you may be seriously injured or killed.**

In addition, it seems some ammunition marked “+P” is not SAAMI compliant either. **There are only four calibers that can carry a “+P” rating from SAAMI.** They are 38 Special +P, 9mm Luger +P, 38 Super Automatic and 45 Automatic +P. **There are no other SAAMI approved “+P” loads.** Any ammunition in any other caliber marked “+P” is not SAAMI compliant, may be dangerous and should not be used.

DANGER for “+P+”

Never use “Plus -P -Plus” (+P+) rated ammunition in any Taurus firearm. The Sporting Arms and Ammunition Manufacturers Institute (SAAMI) does not recognize such ratings and such ammunition can be very dangerous. Firing such ammunition can cause catastrophic failure in firearms resulting in serious bodily injury or death.

WARNING for “+P”

Only fire SAAMI rated Plus P (“+P”) ammunition in Taurus Models designated by Taurus for +P use, as below. Firing +P ammunition in other Taurus products may be dangerous and can result in serious bodily injury or death.

- Model 85 small frame revolver in 38 Special.
- Model 850 small frame revolver in 38 Special.
- Model 851 small frame revolver in 38 Special.
- Model 85 Polymer small frame revolver in 38 Special.
- Model 82 medium frame revolver in 38 Special.
- Model 817 medium frame revolver in 38 Special.
- All firearms chambered in 38 Super Automatic.
- All firearms chambered in 45 Automatic. (ACP)
- All firearms chambered in 9mm Luger.

WARNING

Even if your Taurus firearm is rated for Plus-P (“+P”) ammunition, such ammunition generates pressures significantly in excess of the pressures associated with standard ammunition. Such pressures may affect the useful life of the firearm or exceed the margin of safety built into many firearms. Unless you need +P ammunition, do not use it, particularly for practice.

CAUTION

Discharging firearms in poorly ventilated areas, cleaning firearms, or handling ammunition may result in exposure to lead and other substances known to cause birth defects, reproductive harm, and other serious physical injury. Have adequate ventilation at all times. Wash thoroughly after exposure.

WARNING

This pistol is equipped with a magazine disconnecter. It is intended that the pistol will not fire with the magazine removed, however,

- 1) The magazine disconnecter is not a safety and should not be relied on as such to prevent injury or death.
- 2) The magazine disconnecter can be accidentally bypassed through abnormal handling. If so, the pistol will fire and may result in injury or death.
- 3) The magazine disconnecter may break and allow the pistol to fire with the magazine removed, resulting in injury or death.
- 4) Do not attempt to remove, alter or modify the magazine disconnecter. Injury or death may result.
- 5) If you purchase this product “used” check the operation of the magazine disconnecter as follows: Verify that the magazine is out and visually confirm that the chamber is empty by pulling the slide back with your finger well clear of the trigger. Close the slide, and point the muzzle in a safe direction and attempt to pull the trigger. If the trigger pull is complete and a loud clicking is heard, then the disconnecter may be broken and the firearm should be returned to Taurus customer service for inspection and, if necessary, repair. Failure to do so may result in injury or death.
- 6) If you are unclear about the purpose, function or proper procedures for performing the test, please return the product to Taurus in accordance with your warranty for a free inspection.

WARNING

This pistol is not equipped with a loaded chamber indicator and must be checked as follows:

- 1) Remove magazine by pressing magazine release button.
- 2) Tip up barrel by pushing forward on the barrel catch.
- 3) Visually inspect chamber area of barrel.

4. OPERATING INSTRUCTIONS

1. TO REMOVE THE MAGAZINE. Press the **MAGAZINE RELEASE BUTTON** located near the **TRIGGER-GUARD** with your thumb.

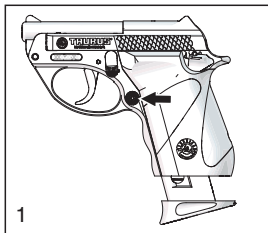

2. TO LOAD THE MAGAZINE. Hold the magazine with one of your hands and with the other one insert the cartridges one at a time, pressing them down and to the rear. Insert the **MAGAZINE** into the pistol until it is held by the **MAGAZINE CATCH**.

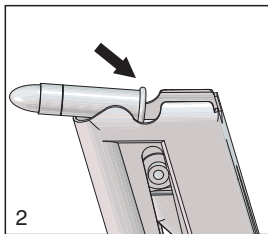

3. TO LOAD CHAMBER. Hold the pistol with one hand keeping your finger AWAY from the TRIGGER. With the other hand pull the SLIDE to its limit and release it. The SLIDE will go forward under RECOIL SPRING pressure and will insert one cartridge in the chamber, or tip up barrel by pushing forward on the barrel catch located above the trigger on the left side of the frame and insert cartridge. Or insert magazine and tip up barrel and then insert cartridge into barrel chamber.

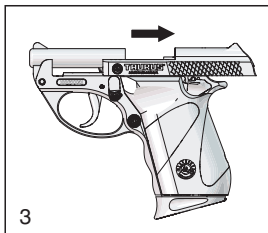

4. TO FIRE PISTOL. The pistol is fired by pulling the TRIGGER. After firing, the SLIDE will recoil from gas pressure and will eject the empty cartridge case and feed another cartridge into the chamber. The pistol will be ready to fire again.

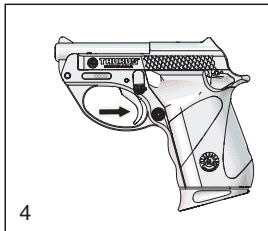

5. If you want to **STOP SHOOTING** before firing the last cartridge of the **MAGAZINE**, **PUT SAFETY LEVER IN THE SAFE POSITION**, i.e. manual safety lever fully up (on). To start shooting again you only have to take safety off and pull the **TRIGGER** as this **TAURUS** pistol is double action.

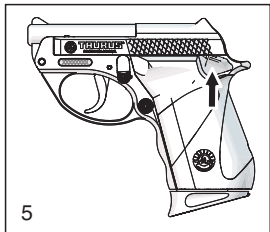

TO UNLOAD THE GUN.

Remove the magazine and tip up barrel and pick out cartridge from chamber.

ATTENTION: Unload your pistol with the muzzle pointing in a safe direction.

5. DISASSEMBLY/ REASSEMBLY

1. Remove the magazine by pressing the magazine release button located behind the trigger guard.

WARNING: ALWAYS MAKE SURE THE FIREARM IS UNLOADED BEFORE FIELDSTRIPPING.

2. Tip up the barrel (by pressing forward on the barrel release lever) and check to make sure the chamber is empty.

3. Pull forward end of slide up and forward removing the slide from the frame.

4. The barrel chamber and slide surfaces can now be cleaned and lightly oiled.

Attention: No further cleaning or disassembly is recommended unless done by a skilled gunsmith.

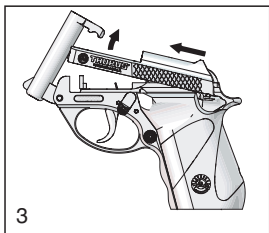
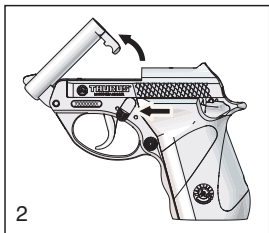
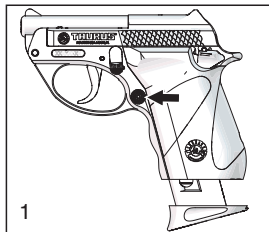

REASSEMBLY

In order to reassemble the pistol, proceed by reversing the disassembly instructions, while observing the following details.

1. When replacing the slide on the frame - make certain that the grooves at rear of the slide engage the “EARS” located at the top rear of the frame, then snap down the front part of the slide onto the frame.

WARNING

SAFETY AGAINST ACCIDENTAL FIRING FROM DROPPING

Like any other precision instrument of small size, this pistol can be damaged or broken by unusual abuse, such as by severe impact on a hard surface. If dropped from a height at which the pistol is normally used, the manual safety provides strong resistance against accidental firing caused by such impact. BUT THE MANUAL SAFETY MUST BE “ON” TO FULFILL ITS FUNCTION. A user who neglects to apply the manual safety runs a greater risk of accidental firing. It is important to recognize that it is impossible to make any small firearm absolutely foolproof against drop firing under all circumstances, so long as a cartridge is loaded in the chamber. The RISK IS ELIMINATED by the simple precaution of leaving the chamber EMPTY until you are ready to shoot. In the event of a severe drop, the pistol should be checked by a competent gunsmith to ensure that no internal damage has occurred which may impair its safety or reliability.

6. CARE AND MAINTENANCE

WARNING: Be certain the firearm is unloaded before cleaning. The firearm may be cleaned and lubricated under normal conditions with the disassembly steps described in section 5.

- In special conditions, such as repairs, when disassembling is necessary, it is recommended the firearm be sent to a competent gunsmith or the importer.
- In order to keep a firearm in perfect condition it must be kept clean and covered with a slight film of good quality oil to prevent corrosion. This is especially necessary after use.
- For normal cleaning of firearm not used or kept in storage for sometime, it is necessary to rub it with a lightly oiled cloth. In the same way proceed with the bore of the barrel. The excess of oil must be removed, but a thin protecting film should remain. Also the dust should be removed from all crevices with a small, clean brush.
- For cleaning after shooting, it is of special importance that all residues of powder be removed from barrel and other adjacent areas subject to such deposits, using an appropriate brush. If particles of lead are detected in barrel they must be scrubbed with a brass brush, drenched with oil. Once cleaned, lubrication should be done as above described.
- Do not keep handguns in contact with materials that attract moisture or possess a certain degree of acidity, or in environments with great variation of temperature or of humidity. Avoid the use of holsters of cloth or of any other material except natural leather appropriately cured.
- If the weapon is to be stored for a long period of time, extreme care should be taken with metal surfaces, in order to protect them against corrosion.

PROTECT YOUR EYES AND EARS

Always wear adequate shooting glasses and ear plugs or “ear muff” type protectors whenever you are shooting. Always make certain that persons close to you are similarly protected. Unprotected eyes may be injured by powder, gas, carbon residue, lubricant, metallic particles or similar debris which may emanate occasionally from any firearm in normal use. Without ear protection, repeated exposure to shooting noise may lead to cumulative, permanent hearing loss.

Empty cartridges are automatically ejected from your pistol at a considerable speed and may cause injury to people close to you.

The pistol slide moves backwards during the shot. Therefore, keep your face away from the pistol. Do not use double-holding, a condition in which the thumb of the hand not used to hold the pistol stays over the other hand.



PART LIST

1	SLIDE	35	GUIDE PIN
3	BARREL	36	LOCKING SCREW PLUNGER SPRING
5	FIRING PIN	37	LOCKING SCREW PLUNGER
7	FIRING PIN SPRING	38	LOCKING SCREW
9	BARREL SPRING PIN	39	SAFETY PLUNGER
10	GROOVED BARREL PIN	40	GRIP
11	EJECTOR SHAFT	41	FINGER REST SCREW
12	HAMMER PIN	42	BUSHING
13	MAGAZINE RELEASE BLUE	43	FRAME
14	HAMMER BLUE	44	HAMMER SPRING STRUT
15	TRIGGER SPRING	45	HAMMER SPRING
16	TRIGGER PIN	46	HAMMER SPRING STRUT BLOCK
17	BARREL RELEASE SPRING	47	SLIDE SPRING PIN
18	SEAR PIN	48	RECOIL SPRING
19	BARREL SPRING	49	SLIDE SPRING BUSHING
20	SLIDE LEVER	50	SLIDE SPRING WASHER
21	MAGAZINE RELEASE BUTTON	51	MAGAZINE BODY (PT22)
22	TRIGGER BAR SPRING	52	MAGAZINE BODY (PT25)
23	TRIGGER	53	FOLLOWER (PT22)
24	BARREL RELEASE	54	FOLLOWER (PT25)
25	MAGAZINE RELEASE SPRING	55	FOLLOWER BUSHING (PT22)
26	PLASTIC INSERT	56	MAGAZINE SPRING (PT22)
27	FIRING PIN RETAINING PIN	57	MAGAZINE SPRING (PT25)
28	TRIGGER BAR	58	MAGAZINE BOTTOM SPRING PLATE
29	SAFETY	59	FINGER REST
30	SAFETY SPRING		
31	MAGAZINE SAFETY LOCK		
32	LOCK SPRING		
33	MAGAZINE SAFETY SPRING		
34	MAGAZINE SAFETY SCREW		

7. EXPLODED VIEW

PT 22/25

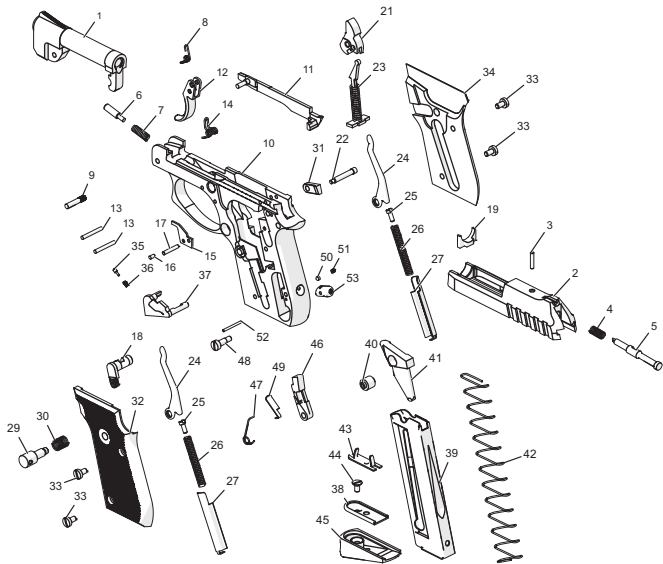

PART LIST

1	BARREL	32	LEFT GRIP PANEL
2	SLIDE	33	GRIP SCREW
3	FIRING PIN RETAINING SPRING	34	RIGHT GRIP PANEL
4	FIRING PIN SPRING	35	SAFETY PLUNGER
5	FIRING PIN	36	SAFETY PLUNGER SPRING
6	BARREL SPRING PLUNGER PIN	37	SAFETY
7	BARREL SPRING	38	MAGAZINE BASE
8	TRIGGER SPRING	39	MAGAZINE BODY
9	BARREL PIN	40	FOLLOWER BUSHING
10	FRAME	41	FOLLOWER
11	TRIGGER BAR	42	MAGAZINE SPRING
12	TRIGGER	43	SPRING BASE
13	TRIGGER PIN	44	FINGER REST SCREW
14	BARREL RELEASE SPRING	45	FINGER REST
15	EJECTOR	46	MAGAZINE SAFETY LEVER
16	EJECTOR PIN	47	MAGAZINE SAFETY SPRING
17	EJECTOR SHAFT	48	MAGAZINE SAFETY SCREW
18	BARREL RELEASE	49	LOCK SPRING
19	PLASTIC INSERT	50	LOCKING SCREW PLUNGER
21	HAMMER	51	LOCKING SCREW PLUNGER SPRING
22	HAMMER PIN	52	GUIDE PIN
23	HAMMER STRUT ASSEMBLY	53	LOCKING SCREW
24	RECOIL LEVER		
25	RECOIL LEVER PIN		
26	RECOIL SPRING		
27	RECOIL SPRING HOUSING		
29	MAGAZINE RELEASE BUTTON		
30	MAGAZINE RELEASE SPRING		
31	MAGAZINE RELEASE		

8. TAURUS SERVICE POLICY

Before shipment, your firearm was carefully inspected and test fired in order to ensure that it conformed to our specifications and standards. Should your firearm require adjustment or repair, we strongly recommend that you return it to Taurus for factory service.

If there is any question regarding the performance of your firearm, please write to our Service Department fully describing all circumstances and conditions involved. If our Service Department makes the determination that your firearm requires factory service, you will be so advised and will be given instructions for the most expeditious handling of your shipment. Our Service Department will give your firearm a complete inspection, and evaluate the problem (s) specified in your letter. If the work required is not covered under the terms of our "Warranty" (when applicable) you will receive an actual cost quotation, not an estimate. Any repair work must be authorized by you, and no work will be done without your expressed approval.

Please follow these suggestions to expedite service in the United States of America to return any firearm to us for adjustment or repair.

1. Federal law permits you to return your firearm to the manufacturer for service via common carriers. However, state and local firearms laws vary greatly; you should consult your local prosecuting attorney regarding any restrictive laws in your jurisdiction regarding your shipment or receipt of firearms. With the above in mind, it is strongly recommended that any firearm sent to us for repair be sent through a Federally licensed dealer.
2. All firearms must be shipped to us prepaid. **WE WILL NOT ACCEPT COLLECT SHIPMENTS.**
3. Be sure to enclose a letter stating your name, address and telephone number, serial number, caliber and barrel length of your firearm. Also state nature of trouble experienced or work required. Merely stating "defective" or "repair as necessary" is inadequate information. Be specific and enclose copies of any previous correspondence. Work (other than warranty repair) will bear minimum labor charge of \$ 10.00.
4. **FIREARMS MUST BE SHIPPED UNLOADED.** Double check the chamber of your firearm before shipping. If firearms are sent to Taurus in a loaded condition, we are required by law to notify the Federal authorities.
5. **DO NOT** include telescopic sights, custom grips, holsters, or other accessories with any firearm shipped to us.

9. TAURUS LIMITED WARRANTY

What Does This Warranty Cover?

This warranty covers any service and repair needed by any product manufactured by Forjas Taurus SA., and imported by Taurus International Manufacturing, Inc. or manufactured in the United States by Taurus International Manufacturing, Inc.

How Long Does Coverage Last?

This warranty is of unlimited duration.

What Will We Do?

Taurus will service and/or repair all covered products free of charge.

What Does This Warranty Not Cover?

This warranty does not cover grips, sights, accessories, cosmetic defects after one year, or damage caused by customer abuse at any time. This express limited warranty is the only warranty on this product. This product is sold "as is" and has no implied warranties of merchantability or fitness for a particular purpose. There are no warranties which extend beyond the description on the face hereof.

How Do I Get Service?

To simplify repair and service Forjas Taurus and Taurus International products are serviced and repaired by Taurus International. Questions regarding the products of either company can be directed to Taurus International in Miami, Florida at 1-305-624-1115 or in writing to:

16175 NW. 49th Avenue

Miami, Florida 33014

In care of Customer Service

If a problem arises, describe the problem in writing and send the firearm to Taurus International at the above address, insured and pre-paid with the written description of the problem enclosed. Within 4 business days of our receipt of your firearm our Customer Service Department will contact you in writing advising you of when to expect your firearm back. We will ship firearms serviced because of defect in materials or workmanship insured and pre-paid. We will ship firearms repaired out of warranty COD. There will, of course, be no charge for parts or labor if the repair work performed is covered by this express warranty.

How Does State Law Apply?

This warranty gives you specific legal rights and you may also have other rights which vary from state to state.

TAURUS NEWS

If you desire to receive periodic e-mails relating to new products from us, you may utilize our product enrollment web page at

<http://www.taurususa.com/product-enrollment.cfm>

Privacy Statement – We do not share, sell or reveal customer information. This information is for our records only. Your e-mail address and purchase information will be kept confidential.

PARTS

All firearms require periodic maintenance and inspection which may reveal a need for adjustment or repair. Have your firearm checked by a competent gunsmith annually, even if it seems to be working well, since breakage, improper functioning, undue wear, or corrosion of some components may not be apparent from external examination. If you notice ANY mechanical malfunction, do NOT continue to use the firearm. UNLOAD the firearm and take it to a competent gunsmith immediately.

Similarly, if water, sand, or other foreign matter enters the internal mechanism, the firearm should be dismantled for complete and thorough cleaning. Failure to keep your firearm clean and in proper working order can lead to a potentially dangerous condition.

Our Service Department maintains a full complement of replacement parts for our firearms of current manufacture. Even though most gunsmiths have the knowledge, training and ability to make the necessary repairs to your firearm, the skill and workmanship of any particular gunsmith is totally beyond our control. Should your firearm ever require service, we strongly recommend that you return it to Taurus. Follow the instructions outlined below. Remember, unauthorized adjustments or parts replacement can void your warranty.

It is the responsibility of the purchaser to be absolutely certain that any parts ordered from Taurus are of the correct type and are properly fitted and installed by a competent person. THIS FIREARM IS A PRECISION MECHANISM AND THE IMPROPER FITTING OF PARTS OR IMPROPER MECHANICAL ADJUSTMENT MAY RESULT IN A DANGEROUS MALFUNCTION, DAMAGE TO THE FIREARM, AND POSSIBLE SERIOUS INJURY TO THE SHOOTER OR TO OTHERS. Therefore, the purchaser and/or installer of parts must accept full responsibility for the correct adjustment of and function of the firearm after such installation has been made or attempted.

Notice:

It is recommended that you record the model number, serial number and date of purchase of your Taurus firearm for future reference. Be sure to retain your store receipt and any other documentation that came with your Taurus.

Model Number _____

Serial Number _____

Date of Purchase _____



This trademark, forged for over 70 years of hard and dedicated work, became a symbol of quality in handguns for civilian, police and military use. This outstanding quality is the result of constant technological evolution and from the devoted work of expert gunsmiths and highly specialized professionals, which makes TAURUS a respected name in more than 75 countries all over the world.

IMPORTANT
DO NOT DISCARD

KEEP THIS MANUAL WITH
YOUR FIREARM UPON
CHANGE OF OWNERSHIP.

FORJAS TAURUS S.A.
Avenida do Forte, 511
CEP: 91.360-000
Porto Alegre - RS - Brasil
Fone: 55-51-30213000
Fax: 55-51-30213110

TAURUS INTERNATIONAL
MANUFACTURING, INC.
16175 NW 49 Avenue
Miami, Florida 33014
Telephone: (305) 624 1115
Fax: (305) 624 1126

www.taurususa.com
www.taurus.com.br

