

# Owner's Manual

Instruction Book for:

**MODEL 887 NITRO MAGNUM™**  
**PUMP ACTION SHOTGUN**

*Remington®*

## IMPORTANT!



This manual contains operating, care, and maintenance instructions. To ensure safe operation, any user of this firearm must read and understand this manual before using the firearm. Failure to follow the instructions and heed the warnings in this manual can cause property damage, personal injury, and/or death.

This manual should always accompany this firearm, and be transferred with it upon change of ownership.

**WARNING!** Keep this firearm out of the reach of children, unauthorized individuals, and others unfamiliar with safe handling of firearms.

Page 2.....	The Ten Commandments of Firearm Safety
Page 7.....	Important Parts of the Firearm
Page 10.....	To Assemble the Firearm
Page 11.....	To Load the Firearm
Page 12.....	To Unload the Firearm
Page 14.....	Lubrication and Maintenance
Page 19.....	To Function Test the Firearm
Page 25.....	Parts List
Page 28.....	How to Obtain Parts and Service

# A Tradition of Performance and Safety.

In 1816 Eliphalet Remington was confident he could make a flintlock that was as good or better than any he could buy. His confidence was well founded. The barrel he handcrafted set a new standard for firearm accuracy and spawned generations of products that have made Remington® America's leading gunmaker. While performance and style are certainly hallmarks of Remington firearms, one factor ultimately drives their performance. Safety. Eliphalet Remington never lost sight of the fact that his rifles were potentially lethal and could kill someone if handled improperly. And after more than 190+ years the same holds true for any firearm, including your new Remington. Eliphalet Remington's first flintlock launched a proud tradition of accuracy and responsibility.



*Eliphalet Remington's first flintlock launched a proud tradition of accuracy & responsibility*

## Safety is Critical to Performance.

A superbly crafted firearm is only as good as the hands that hold it. You can never be too careful. Shooting accidents are often caused by careless oversights such as failing to control the direction of the muzzle, failing to fully engage the safety, leaving ammunition in the chamber or using improper loads. These oversights can result in the destruction of life, limb or property. There's no calling back a bullet once it's been fired, so it's critical that you know the principles of safe firearm handling and storage before you ever take your new Remington firearm out of the box.

The proper use and performance of your firearm depends on correct assembly and maintenance, so it's critical that you familiarize yourself with the information in this instruction book. Even if you're a veteran shooter with a collection of Remington firearms, take the time to read this literature. Not all firearms are the same. That means the first step in safe handling is to learn the features and requirements of your new Remington.

# THE TEN COMMANDMENTS OF FIREARM SAFETY

The Ten Commandments of Firearm Safety should be etched in your memory forever. Let them govern your action wherever and whenever you're involved with firearms. In the field. On the range. Or in your home. Please take the time to review and understand these rules.

## 1st COMMANDMENT

**ALWAYS KEEP THE MUZZLE POINTED IN A SAFE DIRECTION.**

*This is the most important firearm safety rule.* A safe direction is one in which an accidental discharge will not cause injury to yourself or others. Never allow your firearm to point at anything you don't intend to shoot. Be especially careful when you're loading or unloading. Treat every firearm as if it were loaded. And make it a habit to know where the muzzle is pointed at all times, even when your firearm is un-loaded. No one will be injured by an accidental discharge if you keep your firearm pointed in a safe direction. It's as simple as that.

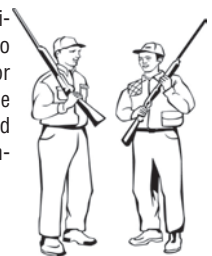

## 2nd COMMANDMENT

**FIREARMS SHOULD BE UNLOADED WHEN NOT ACTUALLY IN USE.**

*Load your firearm only* when you're in the field or on the target range and ready to fire. Never let a loaded firearm out of your sight or out of your hands. Unload it as soon as you're finished shooting - before you bring it into your car, camp or home. Remember, unloading your firearm means unloading it completely, so there is no ammunition in the chamber or in the magazine. Before handling a firearm or passing it to someone else, visually check the chamber, receiver and magazine to be certain they do not contain ammunition. Always keep the firearm's action open when not in use. Never assume a firearm is unloaded even if you were the last person to use it. Always check for yourself.

• *Let common sense rule* when you carry a loaded firearm. If you're in a situation that could risk accidental discharge - such as crossing a fence, wading through a stream or climbing a tree - always unload your firearm. Never pull or push a loaded firearm toward yourself or another person. Never carry a loaded firearm in a scabbard, detached holster or gun case.

• *Certain firearms* (including some Remington® rifles and shotguns) are equipped with internal security devices to prevent unauthorized use. In addition, some firearms owners use external devices, such as cable locks and trigger blocks, for the same purpose. Even if you use such a device, you should still keep your firearm unloaded when stored or not in use. And using internal or external devices cannot substitute, however, for securing your firearms and ammunition in a separate, locked location.



*Firearms should be stored in a secure place where children cannot access them. A gun safe is an ideal way to secure your firearm*

• *Safe storage* of firearms is just as critical as safe handling. Never store firearms loaded. Be sure to keep your firearms in a secure place where unauthorized persons cannot get their hands on them without your knowledge.

• *Take special care* if there are children around. Children are fascinated by firearms. It's a natural curiosity that can have tragic consequences when not properly supervised. Store your firearms in a locked gun safe or some other location that physically bars a child from gaining access.

• *Ammunition* should be stored and locked in a location separate from your firearm. Never leave an unsecured firearm or ammunition in a closet, dresser drawer or under the bed. Remember, it is your responsibility to make sure that children and others unfamiliar with firearms cannot get access to your firearm and ammunition.

## **3rd C O M M A N D M E N T** **DON'T RELY ON YOUR GUN'S SAFETY**

*Treat every Firearm* as if it can fire at any time, whether or not there's pressure on the trigger. Your firearm has been carefully designed to maximize performance and safety. However, because a firearm's safety is a mechanical device, it could fail.

*Human error* is a more likely reason for a firearm safety to fail. By mistake, you may think the safety is on when it really isn't. Or the safety may have been disengaged without your knowledge. Or you could think your firearm is unloaded when there's actually a cartridge or shell in it. A mechanical safety is not a substitute for common sense. It's merely a supplement to your proper handling of a firearm.

*Never touch* the trigger on a firearm until you are ready to shoot. Keep your fingers away from the trigger when you're loading or unloading. Don't pull the trigger when the safety is engaged or positioned between safe and fire.

*Before using your firearm*, read this instruction book to understand the exact location and operation of your firearm's safety. Even when the safety is on, maintain control of your loaded firearm and control the direction of the muzzle. In other words, don't rely on your safety to justify careless handling. If your firearm's internal mechanisms are broken or have been altered, your firearm may fire even when the safety is on. Remember, you and your safe firearm handling practices are your firearm's best safety.

## **4th C O M M A N D M E N T** **BE SURE OF YOUR TARGET AND WHAT'S BEYOND IT.**



You can't stop a shot in mid-air, so never fire unless you know exactly where your shot is going and what it will strike. Never fire at a sound, a movement or a patch of color. A hunter in camouflage can easily be mistaken for a target by an impulsive shooter.

Before you pull the trigger be absolutely sure of your target and what's behind it. Make sure the shot has a backstop such as a hillside or dense material like sand. Remember, bullets can travel great distances with tremendous velocity. Know how far your shot will go if you miss your target or the bullet ricochets.



## 5th C O M M A N D M E N T

### USE PROPER AMMUNITION

*Every firearm is designed* to use a certain caliber or gauge of ammunition. Using the wrong ammunition, mixing ammunition or using improperly reloaded ammunition can cause serious personal injury or death. And it only takes one cartridge or shotshell of the incorrect caliber or gauge, or which has been improperly reloaded, to destroy your firearm. It's your responsibility to make sure the ammunition you use exactly matches the caliber or gauge of your firearm. Refer to this instruction book to find out the specific requirements of your firearm. Always read and heed the instructions on ammunition boxes.

*Confusing shells* or cartridges can cause serious personal injury or death and destroy your firearm. Examine your shells or cartridges closely and use only the precise caliber or gauge for your specific firearm. For example, suppose you accidentally loaded a 20 ga. shell into a 12 ga. shotgun. Because the 20 ga. shell is too small for the chamber, the 20 ga. shell could travel down the barrel and get lodged in the bore. If you then loaded a standard 12 ga. shell behind it and fired, the 12 ga. shot will slam into the lodged 20 ga. shell and may cause the barrel to explode right in your hand. This is commonly called a 12/20 burst, and it can kill you.

*Check all ammunition* before you load it to make sure it matches your firearm's requirements. Every Remington® cartridge and shell is head-stamped with its caliber or gauge for easy identification. Likewise, you'll find the caliber or gauge of your new Remington firearm imprinted on the barrel.

### Reloading Requires Extra Diligence.

*If you're an ammunition reloader*, you are responsible for personally ensuring that the loads and components of your reloaded ammunition meet your firearm's factory-tested standards. Never use ammunition, which has been reloaded by someone else!

*Many shooters handload* as a hobby or to save money on commercial, factory-made ammunition. However, it requires a thorough knowledge of reloading procedures and a deep respect for the explosive potential of gunpowder.

*Firearms are designed*, manufactured and proof-tested to standards based on factory-loaded ammunition. Handloaded or reloaded ammunition that deviates, either intentionally or accidentally, from load or component recommendations can be very dangerous.

Reloaders must observe all possible safety precautions and practices related to the proper handling of explosives. Whether you're a seasoned reloader or just starting out, you should study the subject, watch reloading demonstrations and talk to experienced reloaders.

*The first rule of reloading* is to always follow the manufacturer's instructions for the components you're using. They'll tell you to follow certain guidelines. Namely:

1. Don't mix or substitute powders or primers.
2. Don't use unknown or substandard components.
3. Use only suitable components that have been factory-tested by reputable ammunition, powder and bullet manufacturers.
4. Always be sure to use the manufacturer's recommended recipe when reloading.

*Not following these guidelines* could result in severe injury to yourself or severe damage to your firearm. Dangerously high pressure and explosions can result from an overcharge of powder or other deviations from established reloading guidelines. Be very careful. The process of reloading exposes you to environmentally hazardous material. Lead, which is known to cause cancer and birth defects, is the most common substance in bullets and shot. It is important to handle lead bullets and shot with extreme care. Work only in a well-ventilated area and always wash your hands after exposure and before eating. Never smoke while reloading.

*Primers and powders* are also highly toxic and flammable. So after reloading be sure to clean up all materials from your work area. Don't leave primer or powder spills anywhere on the floor or bench top. Dispose of all waste material in accordance with the manufacturer's recommendations.

*Finally, when reloading* or handloading concentrate on what you're doing at all times. Do not be distracted by talking to others, listening to the radio or watching TV while reloading. Never reload after consuming alcoholic beverages or drugs of any kind. You are working with extremely hazardous materials and you can't risk even a few seconds of distraction. Remember, if you reload, you are the ammunition manufacturer and you are responsible for the performance and safety of your reloaded ammunition.



## 6th C O M M A N D M E N T

**IF YOUR GUN FAILS TO FIRE WHEN THE TRIGGER IS PULLED, HANDLE WITH CARE.**

If for some reason the ammunition doesn't fire when you pull the trigger, stop and remember the 1st Commandment of Firearm Safety - always keep the muzzle pointed in a safe direction. Keep your face away from the breech, then put the safety on, carefully open the action, unload the firearm and dispose of the cartridge safely. Remember that anytime there's a shell in the chamber, your firearm is loaded and ready to use. Even if you tried to shoot and your firearm didn't fire, treat your firearm as if it could still discharge.

## 7th C O M M A N D M E N T

**ALWAYS WEAR EYE AND EAR PROTECTION WHEN SHOOTING.**

Your sight and hearing risk injury from shooting and should be protected at all times. Wear protective shooting glasses to guard against falling shot, clay target chips, powder residue, ruptured cartridge cases and even twigs and branches in the field. Also be sure to wear eye protection when you're disassembling or cleaning a firearm so that tensioned parts (like springs) and cleaning solvents don't come in contact with your eyes. Continued exposure to shooting noise can permanently damage your hearing. On the range, where shooting volume is the loudest, be sure to use the maximum protection of a headset. Learn to use ear protection at all times.



## 8th C O M M A N D M E N T

**BE SURE THE BARREL IS CLEAR OF OBSTRUCTIONS BEFORE SHOOTING.**

Before loading your firearm, open the action and make sure there's no ammunition in the chamber or magazine. Check the barrel for any obstructions or debris. Even a small amount of snow, mud, excess lubricant or grease in the bore can dangerously increase pressure and cause the barrel to bulge or burst when firing. Use a cleaning rod and patch to wipe away anti-rust compounds or any other residues or obstructions in the barrel. Never try to shoot out an obstruction by loading another shell and firing!

When firing, rely on your instincts. If the noise or recoil of your firearm seems weak, stop everything, unload your firearm and be sure nothing is lodged in the barrel. Remember the 12/20 burst? That's what can happen when the barrel is obstructed. Always be sure you're using the correct ammunition in your firearm and that it's free of obstructions.

## 9th C O M M A N D M E N T

**DON'T ALTER OR MODIFY YOUR GUN AND HAVE IT SERVICED REGULARLY.**

Your firearm has been designed to operate according to certain factory specifications. You'll jeopardize your safety and that of others around you by attempting to alter its trigger, mechanical safety or other mechanisms. So never alter or modify your firearm in any way.



Like any mechanical device, a firearm is subject to wear. It must be maintained and periodically serviced to assure optimum safety and performance. Only a qualified service facility should service, repair or modify your Remington firearm. Consult your instruction book for instructions on how to send your firearm to the factory or for the location of the nearest Remington authorized repair station.

Proper cleaning and lubrication are also important to firearm maintenance and are necessary to assure accuracy, safety and reliability. Before cleaning, always make sure that your firearm is completely unloaded. And always clean the barrel from the chamber end to the muzzle when possible.

Make it a practice to clean your bore every time you're going to shoot. Be sure to clean your entire firearm before and after long-term storage and no less than once a year. It's also important to clean your firearm whenever it's been exposed to adverse conditions such as rain, dirt, mud, snow, sleet or saltwater.

For safe and dependable operation of your firearm, all parts of your firearm must be properly cleaned and lubricated. Periodically inspect the internal workings of your firearm to be sure they're clean and free of rust, unwanted dirt and debris.

Use recommended lubricants on your firearm and do not over-lubricate. Excessive use of a non-recommended lubricant could adversely affect the function and safe operation of your firearm. Remember, you are responsible for the proper care and maintenance of your firearm. Failure to properly maintain your firearm cannot only damage or ruin your firearm, it can expose you and others to unnecessary risks of personal injury or death.

Remington® has a wide range of firearm care products and resources for best results when cleaning your firearm. Everything from solvents and lubricants to rods and patches. They're all available from your Remington dealer.



## 10th C O M M A N D M E N T

### LEARN THE MECHANICS AND HANDLING CHARACTERISTICS OF YOUR FIREARM.

Not all firearms are alike. They have different mechanical characteristics that dictate how you should carry and handle them. Anyone who plans to use a firearm should first become totally familiar with the type of firearm it is and the safe handling procedures for loading, unloading, carrying, shooting and storing it.

Before you even unpack your new Remington firearm, read this instruction book from cover to cover and familiarize yourself with the different component parts of the firearm. Then read, understand and follow the Ten Commandments of Firearm Safety in this manual.

**WARNING!** Discharging firearms in poorly ventilated areas, cleaning firearms or handling ammunition may result in exposure to lead, a substance known to cause birth defects, reproductive harm, cancer and other serious physical injury. Have adequate ventilation at all times. Wash hands thoroughly after exposure.



### SHOOT SOBER!!

There's one other rule that must be followed when handling firearms. In fact, respect for this rule is necessary in order to effectively practice the Ten Commandments of Firearm Safety. The rule is: SHOOT SOBER! Firearms and alcohol or drugs make a deadly combination. Never consume anything that would mildly impair your judgment or physical coordination when you're using a firearm. A staggering percentage of the shooting accidents that occur every year involve alcohol or drugs. Be smart. Always shoot sober and stay alive.

**WARNING!** Failure to follow any of these safety rules may cause personal injury or death to the shooter or bystander and damage to property. Do not use a firearm until you fully understand and practice the Ten Commandments of Firearm Safety. If you have any questions about the safe use of a Remington firearm, write to us at Remington Arms Company, LLC, Consumer Service, P.O. Box 700, Madison, NC 27025-0700, or call us at 1-800-243-9700.

### DON'T KEEP THIS TO YOURSELF.

Now that you're a firearm owner you have the obligation to help ensure that shooting sports are safe for everyone - participants and bystanders alike. You can do that by practicing these principles of firearm safety and passing them on to others - especially new shooters. Set an example for beginners. Be a guide to their safe entry into the exciting world of shooting sports. Invest your time and patience for the love of the sport and for its future. After all, it's your love of the sport that led you to buy a new Remington.

Firearm ownership is a right and privilege. It's a right guaranteed in this nation's Constitution. It's a privilege, which carries with it a personal responsibility to use your firearm in a way which will ensure your safety and the safety of others. The preservation of this right and privilege depends on the personal commitment of you and your fellow shooters to the safe and responsible use of firearms. Let the Ten Commandments of Firearm Safety outlined in the manual guide you at all times. Teach and promote these rules whenever you can. Remember, firearm safety depends on you! That's the only way to really enjoy your new Remington firearm and to preserve sport shooting as we know it today.

# Remington® Model 887™ Nitro Magnum Pump Action Shotgun

*Congratulations on your choice of a Remington®. With proper care, it should give you many years of dependable use and enjoyment. For best results, we recommend that you use Remington Ammunition - the ammunition used in factory testing your firearm against our rigorous function and performance standards.*

**PICTURE 1** This picture shows the main parts of a REMINGTON® MODEL 887™ Nitro Magnum Pump Action Shotgun. The picture will aid in understanding the instructions.

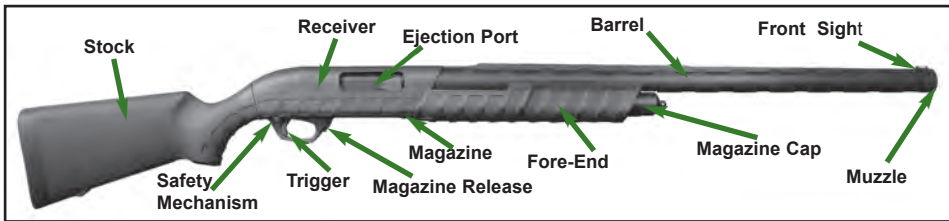

## General Operation

The Remington Model 887™ Nitro Magnum is a pump operated shotgun, incorporating a steel barrel and receiver over molded with high strength polymer. It is capable of firing multiple shots with each cycle of the action and pull of the trigger. At the start of the firing cycle after a chambered shell is discharged the bolt unlocks. As the fore-end or action is opened, the spent shell is pulled from the chamber and expelled out of the receiver through the ejection port. As the fore-end continues rearward the hammer is cocked and the trigger is reset. When the fore-end is in the full rear position, a shell is released from the magazine onto the carrier. As the fore-end is moved forward the carrier rises and places the new shell in front of the bolt. When the fore-end is moved fully forward, the new shot shell is chambered and bolt locks into the firing position, completing the cycle.

## Serial Number, Shotshell Gauge and Length

The serial number is located on the bottom of the receiver. See Picture 2.

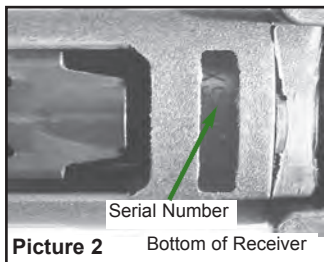

Specifications for the gauge and length of the shotshells intended for use in your firearm are located on the shooter's left side of the barrel.

## IMPORTANT PARTS OF THE FIREARM

**WARNING!** Only use the specified gauge and length shotshell ammunition specified for your shotgun as designated on the barrel. See "To Load Your Firearm." on page 11.

## The Safety Mechanism

The safety mechanism of the Model 887™ Nitro Magnum shotgun provides protection against accidental or unintentional discharge under normal usage when properly engaged and in good working order.

The safety mechanism is not a substitute for following the rules of safe gun handling. The cross-bolt type safety prevents the trigger from being pulled when engaged in the "ON" or "SAFE" position.

To engage the safety mechanism, push the "safety button" located at the rear of the trigger guard to the shooter's right until the button stops and the red band marking CAN-NOT be seen. See Picture 3.

*Always engage the safety mechanism by moving the safety button to the shooter's right before handling, loading or unloading the firearm.*

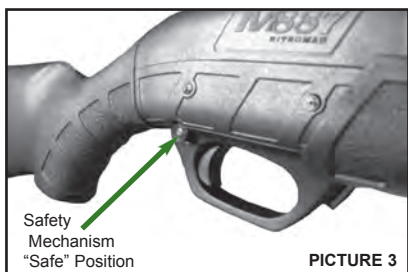

When you are ready to FIRE the firearm, disengage the Safety Mechanism by pushing the Safety Button to the shooter's left until the button stops and the **RED BAND MARKING IS VISIBLE**. See Picture 4. You have now disengaged the Safety Mechanism and the firearm is ready to FIRE.

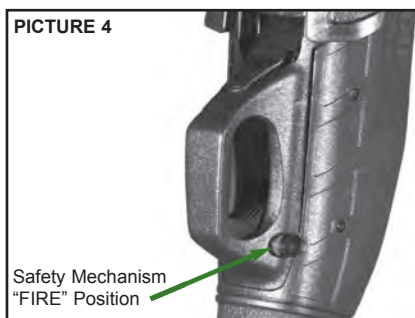

*Do not touch the trigger* while moving the safety button. Your fingers and all other objects should be kept outside of the trigger guard and away from the trigger until you are actually ready to FIRE.

*Never pull the trigger* when the Safety Mechanism is in the "ON" or "SAFE" position.

**WARNING!** The firearm will discharge when the trigger is pulled and the safety mechanism is in the "OFF" or "FIRE" position.

*Even when the safety is engaged in the "ON" or "SAFE" position, careless handling can cause the firearm to discharge.* See the *Ten Commandments of Firearm Safety*, on page 2.

## Additional Features:

Besides the manual safety mechanism, the Model 887™ Nitro Magnum shotguns incorporate passive features providing additional protection against accidental or unintentional discharge under normal usage and in good working order. These passive features such as the inertia firing pin system, steel alloys and/or their metallurgical treatments, the hammer, sear, and trigger engagements, the trigger disconnect, the breech lock-up system, head space, and the trigger guard all work without direct input from the user as long as your firearm is kept clean and in good working order.

**WARNING!** Do not alter, modify, bypass, or render these safety features inoperative.

## The Locking Device

This firearm was originally sold with a key-operated locking device to assist the owner in protecting against unauthorized use. These are storage locking devices and the firearm should be completely unloaded when stored or not in use. Using a locking device cannot substitute for securing your firearm and ammunition in separate locked locations. See the *Ten Commandments of Firearm Safety*, on page 2.

The locking device does not eliminate the need for safe gun handling and storage, including keeping this and every firearm unloaded and locked in a secure place when not in use. read and follow these and other safety rules in this instruction book. Failure to read, understand, and obey these rules can result in serious personal injury or death. See "The Ten Commandments of Firearm Safety," on page 2.

Keep your locking device engaged when your firearm is not in use. Keep the keys in a secure place, inaccessible to others. DO NOT leave your keys or any ammunition with your firearm, which should be kept unloaded and locked in a safe place.



## The Fore-end and Bolt Release

The action will open when the fore-end is moved rearward. The bolt release is used to unlock the bolt. The action can be opened when the bolt release is activated by pushing inward while moving the fore-end rearward. See Picture 5.

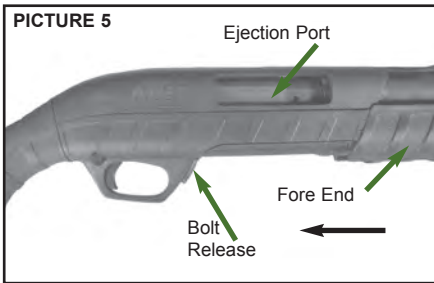

**WARNING!** When the fore-end or action is forward in the closed position and the *safety mechanism* is in the “OFF” or “FIRE” position, the firearm can be discharged by pulling the trigger.

## The Trigger Assembly

*Pulling the trigger DISCHARGES the firearm.*

The trigger assembly of the Model 887™ shotgun is a single-action (SA) system. When the trigger is pulled fully rearward, it starts the firing sequence by releasing the hammer. The trigger assembly is not adjustable. All repairs to the trigger assembly must be made by the factory or a Remington Authorized Repair Center.

**WARNING!** Never place your finger on the trigger unless you are ready to discharge the firearm.

## The Choke Tube

The inside bore constriction at the muzzle end of a shotgun's barrel is known as the “Choke”. When a shot shell is discharged, shot travels down the bore, exiting the muzzle and begins to “spread-out”. The spread of the shot is controlled by changing the muzzle constriction. The Model 887 has a changeable, screw-in, choke tube system. To change or replace the barrel's choke tube, see: “To Change the Choke Tube,” on page 13. For more information about choke tubes, see: *The Remington*

*Guide to Shotguns and Shot Shell Ammunition*, publication or visit our web site at [www.remington.com](http://www.remington.com).

**WARNING!** Unload your firearm before removing or installing a choke tube and the safety mechanism is engaged by placing the safety in the “ON” or “SAFE” position.

**WARNING!** Never discharge your shotgun without a choke tube properly installed, as damage or injury may occur.

**WARNING!** Never discharge steel shot through a lead only choke tube. Choke tubes **NOT** designated for steel will be marked “Lead Only”.

## The Magazine Plug

The standard M887 is provided with a magazine plug is provided with your shotgun to limit the magazine capacity to two (2) shot shells. A limited magazine capacity limit is required by the Federal Migratory Bird regulations and certain state laws. Check with your local Fish & Game Commission or other appropriate authorities to determine whether a magazine plug is required to limit the magazine capacity within your jurisdiction.

To install or remove a magazine plug, See: “To Install the Magazine Plug,” on page 13.

**WARNING!** Before installing or removing a magazine plug, make sure the firearm is completely unloaded and the safety mechanism is engaged by placing the safety in the “ON” or “SAFE” position.

## Sights

**WARNING!** Before adjusting the sights or mounting any telescopic sights, make sure the firearm is completely unloaded and the safety mechanism is engaged by placing the safety in the “ON” or “SAFE” position.

See instructions provided in packaging to change the front sight's fiber optic (lite-pipe).

## Receiver Mounted Optics

The top of the Model 887™ Nitro Magnum receiver maybe drilled and tapped to mount an optic sight mount (not provided). For optic mounting and adjustment, see the instructions provided with your optic sight system.

## The Barrel

**WARNING!** The inside of the barrel must be clean and free of obstructions. See the *Ten Commandments of Firearm Safety*, on page 2.

### To check the Barrel for Obstructions:

1. Always keep the firearm pointed in a safe direction.
2. Engage the safety mechanism by placing the safety mechanism in the "ON" or "SAFE" position. The Red Band Will **NOT** Be Visible.
3. While pressing the bolt release, open the bolt by pulling the fore-end rearward.

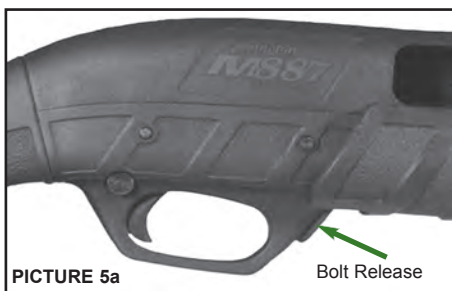

4. Look into the ejection port, visually check the chamber, carrier, and magazine to make sure the firearm is completely unloaded.
5. Insert a cleaning rod into the muzzle.
6. Push the rod completely through the barrel until the rod can be seen at the ejection port.

### To Remove Barrel Obstructions:

**WARNING!** NEVER try to remove an object from the barrel by loading another shotshell and firing. This may cause the barrel to burst or a shotshell to rupture and cause serious personal injury or death.

1. Always keep the firearm pointed in a safe direction.
2. Engage the safety by placing the safety mechanism in the "ON" or "SAFE" position. The Red Band Will **NOT** Be Visible.
3. Press the bolt release and open the bolt by pulling the fore-end rearward.
4. Look into the ejection port, visually check the chamber, carrier, and magazine to make sure the firearm is completely unloaded.

5. To remove the barrel, See: "To Disassemble the Firearm for Cleaning," on Page 15.
6. Insert cleaning rod into the muzzle and lightly tap rod to free object from the barrel.
7. Push rod all the way through the barrel until the rod can be seen at the chamber opening.
8. If an object cannot be easily pushed out of the barrel with a cleaning rod, return the firearm to the factory or a Remington Authorized Repair Center.

### To Assemble the Firearm:

The standard Model 887™ Nitro Magnum was shipped with the barrel assembly removed. See Picture 6. The M887 Tactical is shipped fully assembled.



**Note:** The bore and chamber should be cleaned before assembly. See "Cleaning, Lubrication, and Maintenance," on Page 14.

1. Engage the safety by placing the safety mechanism in the "ON" or "SAFE" position. The Red Band Will **NOT** Be Visible.
2. Visually check the inside of barrel making sure there are no obstructions.
3. Unscrew and remove the magazine cap by turning it counter clockwise.
4. Visually check the barrel making sure there are no obstructions.
5. Slide the cardboard packing ring forward and remove from the magazine tube.

**WARNING!** DO Not pump the action or pull the trigger repeatedly with the barrel removed.

6. Press the bolt release while moving the fore-end approximately halfway rearward. See Picture 5.
7. Insert the barrel into the receiver and the barrel ring over the magazine tube. See Picture 7.

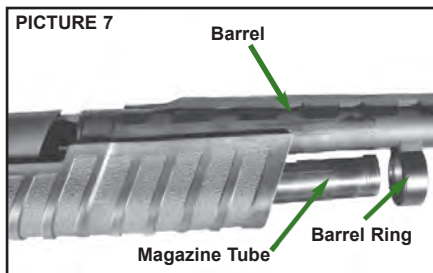

8. Once the barrel is fully inserted into the receiver, replace the magazine cap on top of the magazine tube. Tighten by turning clockwise until hand-tight.
9. Always point the firearm in a safe direction.
10. Open the bolt by pressing the bolt release while moving the fore-end fully rearward.

## To Load the Firearm:

**WARNING!** The specific gauge and length of shotshell ammunition suitable for use in your firearm is marked on the barrel. Different gauges and shell lengths are not interchangeable. Do not use any ammunition other than the designated gauge and length specified for your shotgun. Using incorrect ammunition in your firearm can result in a severe malfunction of your firearm or ammunition leading to personnel in jury or death. See the *Ten Commandments of Firearm Safety*, on page 2.

## Ammunition

Always check the shotshell for the correct gauge and length before loading the firearm. To find additional information on shotshells ammunition, see publication: *The Remington Guide to Shotguns and Ammunition* at [www.remington.com](http://www.remington.com).

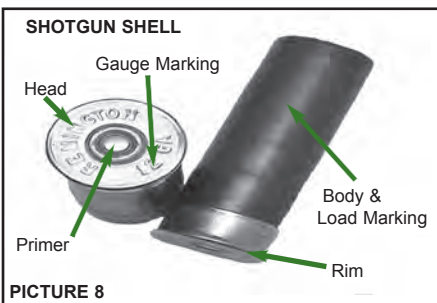

## To load the Chamber and Magazine:

**NOTE:** The bore should be cleaned before loading the firearm the first time. Follow cleaning instructions shown on Page 16, "To Clean Barrel."

1. Always keep the firearm pointed in a safe direction.
2. Engage the safety by placing the safety mechanism in the "ON" or "SAFE" position. The Red Band Will **NOT** Be Visible.
3. While pressing the bolt release, open the action by pulling the fore-end rearward.
4. Look into the ejection port, visually check the chamber, loading port, and magazine to make sure the shotgun is completely unloaded.
5. Ensure the barrel and chamber are free of obstructions, see page 10, "To Check the Barrel for Obstructions."

## To Load the Chamber:

6. Put one shell of the correct gauge and length through the ejection port.
7. Move the fore-end forward, closing the action.

## To Load the Magazine:

8. Push up to four (4), 2 3/4" cartridges or 3" cartridges or three (3), 3 1/2" cartridges of the correct gauge, one at a time, fully forward into the magazine tube, ensuring the rim of each shell engages the feed latch and is held inside the magazine tube.

## To Load a Tactical Magazine:

- 8a. Push up to seven (7), 2 3/4" cartridges or six (6), 3" cartridges or five (5), 3 1/2" cartridges of the correct gauge, one at a time, fully forward into the magazine tube, ensuring the rim of each shell engages the feed latch and is held inside the magazine tube.

**WARNING!** The firearm is now cocked and fully loaded. Make sure the safety mechanism is still engaged in the "ON" or "SAFE" position. The Red Band Marking Will **NOT** be Visible. Always keep the firearm pointed in a safe direction.

## To Load The Chamber From The Magazine:

1. Always keep the firearm pointed in a safe direction.
2. Engage the safety by placing the safety mechanism in the "ON" or "SAFE" position. The Red Band Will **NOT** Be Visible.
3. With the bolt open, visually check the chamber, ejection port, carrier, and magazine making sure the firearm is completely unloaded and the barrel is free of obstructions.
4. Close action by moving the fore-end fully forward.
5. Load the magazine as described on page 11, see: "To load the Magazine" or "To load a Tactical Magazine."
6. Open the bolt by pressing the bolt release while moving the fore-end fully rearward.
7. Place the shell in the chamber by closing the bolt or moving the fore-end fully forward until the bolt locks into position.

**WARNING!** The firearm is now cocked and fully loaded.

## To Discharge the Firearm:

**WARNING!** Always wear eye and hearing protection when discharging your firearm. See the *Ten Commandments of Firearm Safety*, on page 2.

1. Point the muzzle at your intended target.
2. Disengage the safety mechanism by moving the safety button to the "OFF" or "FIRE" position. The Red Band Will Be Visible.
3. With the butt of the firearm firmly mounted against your shoulder and target acquired, pull the trigger. The firearm will discharge each time the trigger is pulled and the action is cycled until the magazine and chamber are empty.



**WARNING!** If a cartridge does not discharge when the trigger is pulled (misfire), keep the firearm pointed in a safe direction and wait one minute before opening the bolt. See: "To Unload the Firearm," on page 12.

**WARNING!** If the "report" of the shot is noticeably softer or louder or any way irregular, keep the firearm pointed in a safe direction; unload the firearm and check for bore obstructions. See on page 10, "To Remove a Barrel Obstruction."

4. Engage the safety mechanism by placing the safety button in the "ON" or "SAFE" position. The Red Band Will **NOT** Be Visible.
5. Look into the ejection port, visually check the chamber, loading port, and magazine to make sure the firearm is completely unloaded.

## To Unload the Firearm:

### To UNLOAD BY USING PUMP ACTION:

**WARNING! NEVER** assume your firearm is unloaded to justify careless handling. Always control the direction of the muzzle of your firearm, even if you think it is completely unloaded.

1. Keep the firearm pointed in a safe direction throughout the unloading process.
2. Engage the safety by placing the safety mechanism in the "ON" or "SAFE" position. The Red Band Will **NOT** Be Visible.
3. Open the bolt by pressing the bolt release while moving the fore-end slowly rearward until the shell clears the chamber.
4. Lift the front of the shell outward and remove it from the ejection port.
5. Continue to move the fore-end fully rearward until the next shell is released from the magazine onto the carrier.
6. Tip the firearm sideways allowing the shell to drop from the ejection port.
7. Close the action by moving the fore-end forward.
8. Repeat opening and closing the action (steps 5 through 7) until all shells are removed from firearm.
9. With the bolt open, visually check the chamber, carrier, and magazine making sure the firearm is completely unloaded.

## To Unload the Magazine Manually:

1. Keep the firearm pointed in a safe direction throughout the unloading process.
2. Engage the safety by placing the safety mechanism in the "ON" or "SAFE" position. The Red Band Will **NOT** Be Visible.
3. Push the carrier up against the bolt carrier exposing the staged shell in the magazine.

**WARNING!** Shells in the magazine are under spring compression. Wear eye protection to avoid possible serious personal injury.

4. Push the left (feed) latch in toward the receiver wall until the staged shell is released from the magazine. See Picture 9.

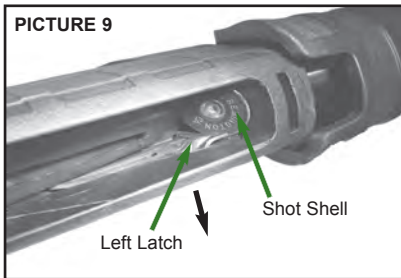

5. Repeat step 4 until all shells are removed from magazine and the orange follower can be seen.
6. Open the bolt by pressing the bolt release while moving the fore-end slowly rearward until the shell clears the chamber.
7. Lift the front of the shell outward and remove from ejection port.
8. Look into the ejection port and visually check the chamber, carrier, and magazine to make sure the firearm is completely unloaded and free of obstructions.

## To Change the Choke Tube:

**WARNING! COMPLETELY UNLOAD** the firearm before changing the choke tube. See: "To Unload the Firearm," on page 12.

1. Always keep the firearm pointed in a safe direction.

2. Engage the safety by placing the safety mechanism in the "ON" or "SAFE" position. The Red Band Will **NOT** Be Visible.
3. Open the bolt by pressing the bolt release while moving the fore-end fully rearward.
4. With the bolt open, look into the ejection port and visually check the chamber, carrier, and magazine to make sure the firearm is completely unloaded. Change the choke tube only when the bolt or action is open.
5. Place the choke tube wrench supplied with your shotgun into the choke tube. See Picture 10.

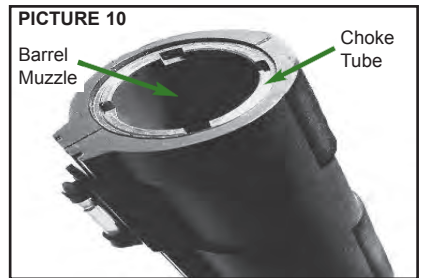

6. Turn the choke tube wrench counter-clockwise until the choke tube can be removed from the barrel.
  7. Select the desired choke tube and insert into the barrel muzzle.
  8. Place the choke tube wrench onto choke tube and tighten by turning clockwise. **Do Not Over Tighten!**
  9. With the Safety in the "ON" or "SAFE" position, bolt open, and the chamber and magazine completely unloaded, check the choke tube periodically to make sure it is tight and secure.
- NOTE:** NEVER discharge the shotgun without a choke tube installed.

## To Install the Magazine Plug:

1. Point the firearm in a safe direction.
2. Engage the safety by placing the safety mechanism in the "ON" or "SAFE" position. The Red Band Marking Will **NOT** Be Visible.
3. Completely unload the magazine and chamber. With the bolt open, look into the ejection port and visually check the chamber, carrier, and magazine to make sure the firearm is completely unloaded. Also make sure the barrel is free of obstructions.



4. Remove the magazine cap by turning counter clockwise.
5. Place a large slotted screw driver into the magazine retainer. See Picture 11.

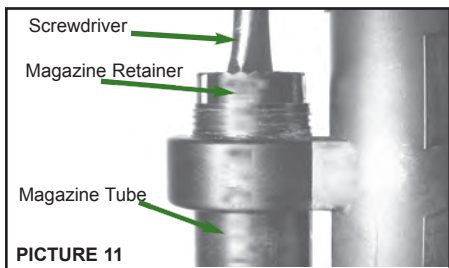

**PICTURE 11**

6. Push down on the screw driver and retainer (approximately) one (1) inch or until you can turn the screw driver.

**WARNING!** Use extreme care when removing the magazine retainer, as the magazine spring is under compression. Wear eye protection to avoid possible serious personal injury.

7. Turn the screwdriver approximately 1/4 turn. Slowly release the magazine spring retainer as it is under pressure. Remove magazine retainer. Do not remove the magazine spring.
8. Place the magazine plug, small end first, into the magazine spring. See Picture 12.

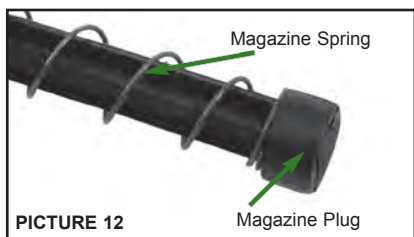

**PICTURE 12**

9. Place the open end of the magazine spring retainer on top of magazine plug.
10. While holding the magazine spring and retainer with one hand, place a slotted screw driver in the slot on top of the retainer.
11. Push the magazine spring, plug, and retainer into the magazine tube while aligning the magazine spring retainer detent slots with the detents in the magazine tube. See Picture 13.

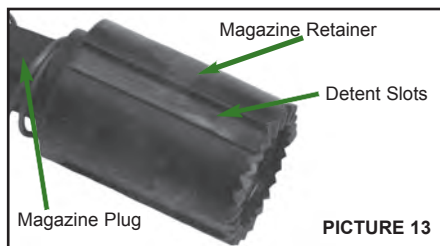

**PICTURE 13**

12. Once the detents are aligned, push the magazine spring, plug, and retainer down in the magazine tube (approximately 1 1/2 inches) until the screw driver can be turned 1/4 of a turn or until the detents are misaligned locking the retainer in position.
13. Slowly remove the screw driver. When properly seated, the magazine spring retainer will be 1/4 inch higher than top of the magazine tube.
14. Replace the magazine cap by turning it clockwise until tight. **Do not over tighten.**

## Cleaning, Lubrication and Maintenance

**WARNING!** Before cleaning, make sure your firearm is completely unloaded (both the chamber and the magazine) and engage the safety mechanism in the "ON" or "SAFE" position.

**WARNING!** After each use, follow the lubrication and maintenance directions in this Manual. If the firearm is immersed in water, it must be thoroughly cleaned and lubricated as soon as possible. In case of saltwater immersion, first flush all parts with fresh water, then dry, clean and lubricate the firearm. If the firearm does not function properly, have it checked and corrected by a Remington Authorized Repair center before further use. Failure to follow these instructions may lead to firearm malfunctions which could result in serious personal injuries or death.

**NOTE:** The chamber and bore should be cleaned before loading and firing the firearm the first time.

## Lubrication

**Over-lubrication** should be avoided at all times. A light application of Rem™ Oil helps to prevent rusting.

**WARNING!** Excessive use of a lubricant could adversely affect the function and safe operation of your firearm. Failure to properly maintain your firearm can not only damage your firearm, it can expose you and others to unnecessary risks of personal injury or death.



When the firearm is to be stored, it should be carefully cleaned and thoroughly oiled. Outside metal surfaces should be wiped with Rem™ Oil occasionally. When the firearm is to be reused, all excess lubrication must be removed. The chamber and bore must be thoroughly wiped dry.

For safe and dependable operation of your firearm, the barrel and action must be cleaned periodically.

Remington recommends using Remington cleaning products and lubricants or their equivalents.

**WARNING!** The use of a non recommended lubricant or cleaner could adversely affect the function and safe operation of your firearm. Do not use congealing lubricants. The use of non-congealing lubricants such as Rem™ Oil is strongly recommended.

**NOTE:** Remington's Rem™ Oil is available from your local dealer. If your dealer is out of stock, ask the dealer to order Rem™ Oil from the Remington Distributor.

## To Disassemble the Firearm for Cleaning:

**CAUTION:** The Model 887 NITRO MAGNUM shotgun should not be disassembled beyond what is described in this manual, except by the factory or a Remington Authorized Repair Center.

**WARNING!** Unload the firearm before cleaning. Look into the ejection port and visually check the chamber, loading port, and magazine to make sure there are no shells in the firearm. Always wear eye protection when disassembling and reassembling the firearm.

## To Remove the Barrel:

1. Always keep the firearm pointed in a safe direction.
2. Engage the safety by placing the safety mechanism in the "ON" or "SAFE" position. The Red Band Will **NOT** Be Visible.
3. With the bolt open, look into the ejection port and visually check the chamber, carrier, and magazine to make sure the firearm is completely unloaded.
4. Slide the fore-end forward; approximately halfway.
5. Remove the magazine cap by turning it counterclockwise.
6. Hold the barrel above the barrel ring then pull the barrel from the receiver. See Picture 14.

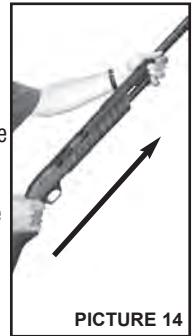

## To Remove a Barrel with a Magazine Extension - M887 Tactical:

7. Remove all tack rail accessories.
8. Remove the tack rail from the extension magazine barrel clamp by unscrewing the tack rail mounting screw. See Picture 15.

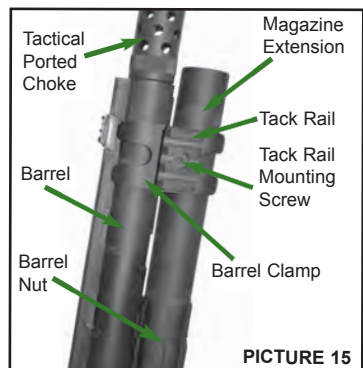

- Remove the magazine barrel clamp by (1) removing the two mounting screws; (2) remove the right and left magazine barrel clamp from the barrel and magazine extension. See Picture 16.

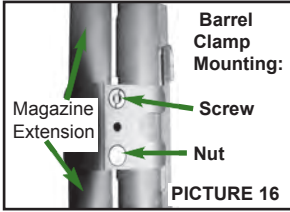

- With the barrel clamp removed, unscrew the extended magazine by turning the barrel nut counterclockwise. See Picture 17.

**WARNING!** Use extreme care when removing the extended magazine, as the magazine spring is under compression. Wear eye protection to avoid possible serious personal injury.

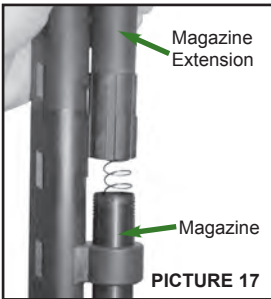

- Lift the magazine extension from the magazine spring.
- Remove the magazine spring from the magazine tube. Do not remove the magazine follower.

### To Remove the Trigger Assembly:

- Tap out the front and rear trigger assembly pins with a drive punch. See Picture 18.

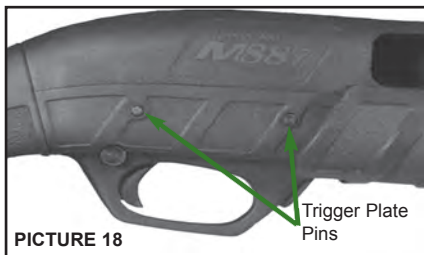

- Remove the trigger assembly from the receiver by pulling it downward. See Picture 19.

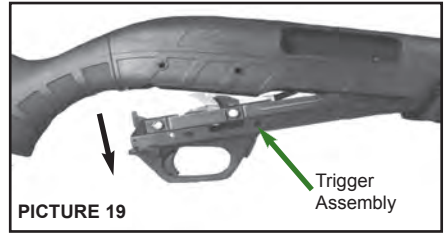

### To Remove the Bolt Slide:

- With the barrel and trigger assembly removed, move the fore-end forward until bolt assembly is free of receiver. See Picture 20.

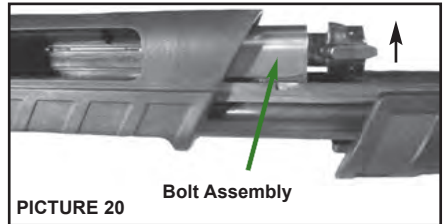

- Remove the bolt assembly from the action bars by lifting the bolt assembly upward.
- Remove the port cover from the bolt assembly by lifting the port cover over the port cover guide pin and then lift upward.

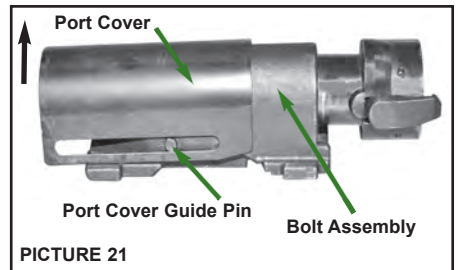

See Picture 21.

### To Clean Barrel:

**WARNING!** The use of a non recommended lubricants or cleaners could adversely affect the function and safe operation of your firearm.

- Use the instructions and equipment provided in a quality cleaning kit such as a Remington® Cleaning Kit. For recommendations, see your dealer or a

- Remington Authorized Repair Center.
- Saturate the cleaning patch with Brite Bore™ or equivalent.
  - Attach the patch to a cleaning rod tip.
  - Pass the patch through bore from the chamber end to the muzzle several times removing loose residue and fouling.
  - Select the correct caliber cleaning brush and attach a brush to the cleaning rod.
  - Spray the bore brush with Brite Bore.
  - Push the cleaning rod through the barrel several times.
  - Remove the brush from the rod and attach a tip with a cleaning patch.
  - Push the cleaning patch through the bore.
  - Repeat several times using a new cleaning patch each time until the patch is removed from the barrel without fouling residue.
  - Remove all shooting residue from the lock notch in the barrel with Rem™ Action Cleaner. See Picture 22.

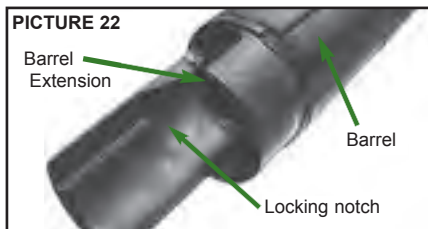

- Push a clean patch saturated with Rem™ Oil through the barrel.
- Push a clean dry patch through the barrel to remove excess lubricant.
- Apply a light application of Rem™ Oil to the outside of the barrel extension with a soft clean cloth.

**WARNING!** After cleaning, make sure the barrel is free of obstructions.

### To Clean the Choke Tube:

- Remove the choke tube from the barrel. See "To Change the Choke Tube," page 13.
- Clean the choke tube, including the threads, with Rem Action Cleaner and wipe clean.
- When dry, apply Rem Oil to the choke tube threads and reattach to barrel. See "To Change the Choke Tube," page 13.

### To Clean the Bolt Assembly:

- Spray the bolt assembly and bolt head using Rem Action Cleaner and brush. See Picture 23.

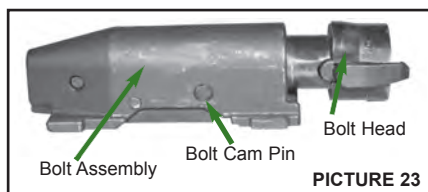

- Compress the bolt head into the bolt assembly. Ensure the bolt head moves freely and returns forward without hesitation. See Picture 24.



- With the bolt head compressed, push the firing pin from the rear. Ensure the firing pin moves freely forward and returns without hesitation. See Picture 25.

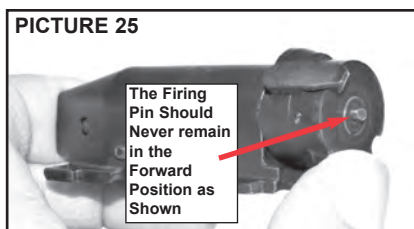

- If the firing pin does not move freely or remains forward, flush the firing pin with Rem Action Cleaner and repeat step 23.

**WARNING!** If the firing pin does not move freely or return without hesitation; the bolt assembly is NOT safe to use. The use of a firearm that is not in a safe operating condition may result in serious personal injury or death. Return the firearm to the factory or to a Remington Authorized Repair Center.

- Wipe clean and let dry before applying a light application of Rem Oil to the bolt assembly, firing pin, and bolt head.
- Ensure the bolt can pin is present and secure.
- To insert the bolt cam pin, compress the bolt head into the bolt assembly until the cam pin can be inserted fully into the bolt assembly. Once the cam pin is fully inserted, slowly release the bolt head.

**WARNING!** When the bolt cam pin is not in the bolt assembly, the firearm is **NOT** safe to use. Leaving the bolt cam pin out of the assembly can cause serious personnel injury or death to you and others.

### To Clean the Trigger Assembly:

**WARNING!** The use of a non recommended lubricants or cleaners could adversely affect the function and safe operation of your firearm.

- Thoroughly spray Rem Action Cleaner inside the trigger assembly where specified in Picture 26.

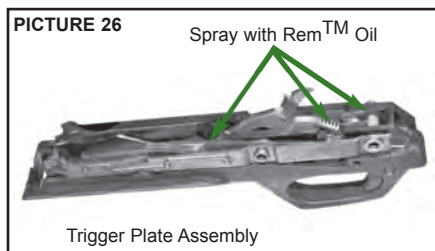

- Thoroughly dry the trigger assembly either by compressed air or let air dry.
- Disengage the safety mechanism by moving the safety button to the shooter's left.
- With your thumb on hammer and the safety disengaged, pull the trigger rearward and release, see Picture 27. Repeat multiple times. Ensure the trigger returns completely to the forward position each time. Repeat step 1 thru 4 if the trigger does not fully return.

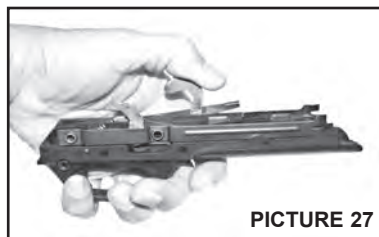

PICTURE 27

**WARNING!** If the trigger does not fully return to the forward position each time it is released, then your firearm is **NOT** in a safe operating condition and it must **NOT** be used until you have had it repaired by a Remington Authorized Repair Center.

The use of a firearm that is not in a safe operating condition may result in serious personal injury or death.

- With the hammer fully rearward in the cocked position; engage the safety mechanism, multiple times, in the "ON" or "Safe" position by moving the safety button fully to the shooter's right. The red band will **NOT** be visible.
- The safety button must be positioned fully in the "ON" or "**SAFE**" position. The safety should **NOT** remain in a position between the "SAFE" and "FIRE" position. If the safety mechanism does not freely return to the full "SAFE" or "FIRE" position, repeat steps 1 and 2. **If the safety mechanism does not freely return to the "SAFE" or "FIRE" position after repeating operations 1 and 2, send the firearm to a Remington Authorized Repair Center for an inspection of the safety and trigger assembly.**

**WARNING!** If the safety mechanism does not freely return to the full "SAFE" or "FIRE" position; then your firearm is **NOT** in a safe operating condition and it must **NOT** be used until you have had it repaired by a Remington Authorized Repair Center. The use of a firearm that is not in a safe operating condition may result in serious personal injury or death.

- Apply a light application of Rem Oil to the areas specified in Picture 26.



## To Clean the Receiver Assembly:

1. Thoroughly spray and brush all components inside the receiver using Rem Action Cleaner or equivalent.
2. Air dry or use compressed air to thoroughly dry the receiver assembly.
3. Wipe with a clean cloth and air dry or use compressed air to thoroughly dry the magazine tube.
4. Apply a light application of Rem Oil to the inside and outside of the receiver.
5. Remove all excess lubricant with a clean dry cloth.

**NOTE:** While your firearm has been designed and manufactured to provide improved corrosion protection, only proper care will keep your firearm in a good operating condition and maintain its appearance. After extensive use, the protective coating on plated parts may be worn sufficiently, reducing the corrosion protection. Such worn parts should be replaced to assure the integrity of the corrosion protection. Remington recommends you have your firearm serviced periodically by a Remington Authorized Repair Center ensuring the proper function and replacement of any worn parts. For firearm service see: "Repair Service," on Page 26.

## To Reassemble The Firearm:

**WARNING!** Visually check the chamber, loading port, and magazine to make sure the firearm is completely unloaded and there are no shot shells anywhere in the firearm.

1. With the port cover guide slot on the right side of the bolt assembly. Place the port cover over the port cover guide pin on the bolt assembly then snap the top of the port cover into place. See Picture 21.
2. Center the action bar support (used only to aid in assembling the bolt and action bars into the receiver) between the two action bars and the bolt carrier notches. See Picture 28.
3. Place the bolt assembly onto the action bars with the bolt head oriented toward the fore-end. Ensure all four bolt carrier tabs are fully seated into the bolt carrier notches. See Picture 29.

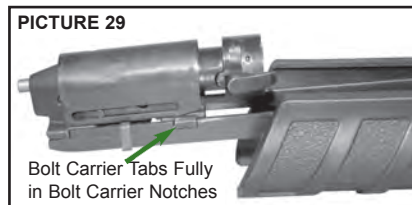
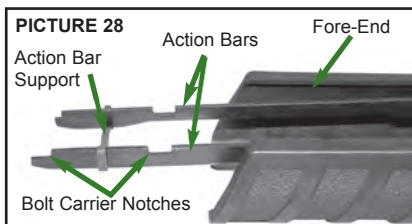

4. Insert the bolt assembly, action bars, and fore-end onto the magazine tube as shown in picture 30.

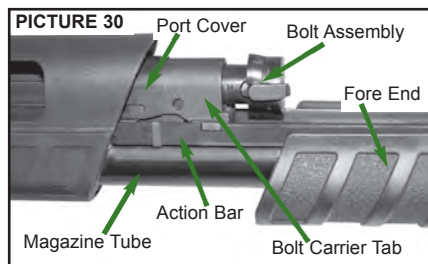

5. Align the action bars with the right and left action rails in the receiver.
6. With the action bars aligned with receivers action rails, move the fore-end rearward; sliding the bolt assembly halfway into the receiver.
7. Insert the barrel into the receiver and align the barrel ring over the magazine tube. See Picture 7.
8. Replace the magazine cap on top of the magazine. Secure by turning clockwise until hand tight. Do not over tighten.

Note: To complete assemble for a standard configuration, see step 9 on page 20.

## To Assemble a Magazine Extension:

- 1e. Place the extension magazine spring into the magazine tube.
- 2e. Slide the extension magazine over the extension magazine spring. See Picture 16.
- 3e. Push the extension magazine tube over the magazine spring and tighten the barrel nut by turning it clockwise. Do not over tighten. See Picture 31.

- 4e. Place the right and left barrel clamp onto the magazine and the barrel.
- 5e. Align the smaller radius of the barrel clamp over the magazine. The orientation of the barrel clamp may be indicated by an arrow toward the magazine. (Not Shown). See Picture 32.

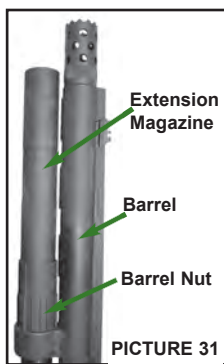

10. Align the trigger assembly with the mounting holes in the receiver. If the mounting holes do not align, press the bolt release while holding the trigger assembly in the receiver, then move the fore-end fully rearward, then move the fore-end fully forward.
11. Once the action is forward and the trigger assembly mounting holes are aligned with receiver, tap in the longer front trigger plate pin.
12. Then tap the shorter rear trigger plate pin. See Picture 35.

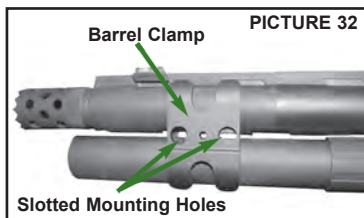

- 6e. Push the slotted mounting screws through the mounting holes in the barrel clamp.
- 7e. Secure the barrel clamps using the slotted barrel clamp mounting nuts. Do not over tighten. See Picture 33.

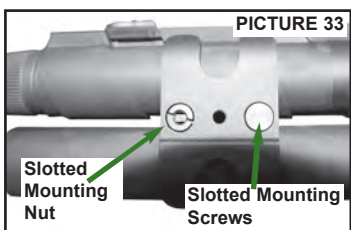

9. Insert the trigger assembly by aligning the front tab into receiver. See Picture 34.

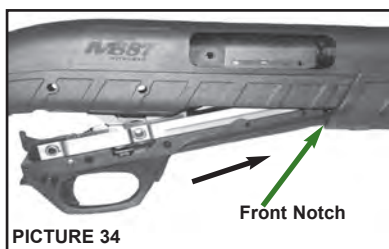

## To Function Test Firearm:

When the firearm is reassembled, a short function test should be conducted to ensure proper operation before loading or discharging the firearm. If the firearm does not function as described in any of the Function Test, the firearms should be reassembled and function tested again. If the firearm fails the function test again, the firearm should be sent to a Remington Authorized Repair Center or call: Remington's customer service number, 1-800-243-9700, Mon-Fri., 9:00 AM-5:00 PM Eastern time.

**WARNING!** Completely unload the firearm before Function Testing. Look into the ejection port and visually check the chamber, carrier, and magazine to make sure there are no shells in the firearm. Always wear eye protection when handling the firearm.

1. Always keep the firearm pointed in a safe direction throughout the Function Testing process.
2. Engage the safety mechanism in the "ON" or "Safe" position by moving the safety button fully to the shooter's right. The red band will NOT be visible.
3. Open the action by pressing the bolt release then sliding the Fore-end rearward. See Picture 5.

4. With the bolt open, visually check the chamber, loading port, and magazine making sure the firearm is completely unloaded. If the chamber is not unloaded, see page 12, "To Unload the Firearm."
5. Make sure the barrel and chamber are free of obstructions, see "To Check the Barrel for Obstructions," on page 10.
6. Close the action smartly by quickly moving the Fore-end fully forward. The hammer should NOT release.

**WARNING!** If the hammer does **NOT** remain cocked when the action is smartly closed, the firearm is **NOT** safe to use. Using the firearm in this condition may lead to firearm malfunctions which could result in serious personal injury or death. Return the firearm to the factory or to a Remington Authorized Repair Center. The use of a firearm that is not in a safe operating condition may result in serious personal injury or death.

7. With the safety mechanism engaged, pull the trigger fully rearward. The trigger should not move and the hammer should NOT release.
8. To check if the hammer released in step 6 or 7, disengage the safety mechanism by moving the safety button to the "OFF" or "FIRE" position. The red band will be visible. Pull the trigger fully rearward. The hammer should release.
9. After the trigger is pulled and released, verify the trigger returns to the fully forward position.

**WARNING!** If the trigger does not fully return to the forward position each time it is released, or the hammer releases anytime the safety mechanism is engaged, your firearm is **NOT** in a safe operating condition and it must **NOT** be used until you have it inspected and the problem corrected by a Remington Authorized Repair Center. The use of a firearm that is not in a safe operating condition may result in serious personal injury or death.

10. Open the action by pressing the bolt release then sliding the Fore-end rearward. See Picture 6.

11. Close the action by moving the Fore-end fully forward.
12. Without touching the trigger, pull the Fore-end rearward. The bolt and Fore-end should not move and the action should remain locked, in the forward position.

**WARNING!** If the action opens when the trigger has not been pulled or the bolt release pressed, the firearm is **NOT** safe to use. Using the firearm in this condition may lead to firearm malfunctions which could result in serious personal injury or death. Return the firearm to the factory or to a Remington Authorized Repair Center. The use of a firearm that is not in a safe operating condition may result in serious personal injury or death.

13. Check the disconnector operation by disengaging the safety mechanism by moving the safety button to the "OFF" or "FIRE" position. The red band will be visible. Pull the trigger fully rearward. The hammer should release.
14. Release the trigger and cycle the action by move the fore-end fully rearward then fully forward.
15. Press the bolt release and move the fore-end rearward about 1/4 of an inch. (Out-Of-Battery)
16. Pull the trigger fully rearward. The hammer should not release.
17. To check if the hammer released in step 16, remove your finger from the trigger and slide the fore-end fully forward. Pull the trigger fully rearward. The hammer should release and fall forward.

**WARNING!** If the hammer does **NOT** remain cocked when the bolt is out-of-battery, the firearm is **NOT** safe to use. Using the firearm in this condition may lead to firearm malfunctions which could result in serious personal injury or death. Return the firearm to the factory or to a Remington Authorized Repair Center. The use of a firearm that is not in a safe operating condition may result in serious personal injury or death.

18. Repeat steps 13 thru 17 multiple times.
19. Engage the safety mechanism in the “ON” or “Safe” position. The red band will NOT be visible.
20. With the Safety in the “ON” or “SAFE” position, the bolt open, and the chamber and magazine completely unloaded, verify the choke tube is present, tight, and secure.

**WARNING!** Incorrectly assembling the firearm or with modified parts can result in damage to your firearm, personal injury or death to you or others. Remington recommends all service and replacement of components be performed by a Remington Authorized Repair Center. If a repair or component replacement was not completed by a Remington Authorized Repair Center we recommend that you have your firearm checked by an Authorized Repair Center. See page 28, for a Remington Authorized Repair Center nearest you.

**The firearm owner and user must accept full responsibility for the correct reassembly and functioning of the firearm after disassembly or replacement of parts.**

---

### **Firearm Sale or Transfer:**

If your firearm has been adjusted or changed in any way and you intend to sell or otherwise transfer possession of your firearm, you must: (1) provide a complete service record, (2) warn the purchaser or recipient of your firearm that it has been adjusted or modified, and (3) give the purchaser or recipient this owner's manual for review and reference. If you do not wish to sell or transfer your firearm in an adjusted condition (recommended), return it to a Remington Authorized Repair Center for restoration of your firearm to the original factory conditions. Do Not attempt to restore the firearm to factory conditions yourself.

**WARNING!** NEVER alter or modify any part of the firearm. Improper alterations can make the firearm unsafe and result in personal injury or death to you or others.

This firearm should not be sold where prohibited by federal, state or local laws.

All rights to this instruction manual are reserved. The information in this document is subject to change without notice. Remington reserve the right to change the content herein without the obligation to notify any person or organization of such changes.

Remington® is a registered trademark of Remington Arms Company, LLC and may not be used in any way without the express written consent of Remington Firearms. All other trademarks used herein remain the exclusive property of their respective owners. Nothing contained in this manual should be construed as granting, by implication or trademarks displayed herein. Misuse of any trademarks or any content of this manual is strictly prohibited. Remington shall aggressively enforce its intellectual property rights to the fullest extent of the law.

## Firearm Maintenance Record

DATE	Service	Performed By



# MODEL 887™ Nitro Magnum

## Pump Action Shotgun Exploded View

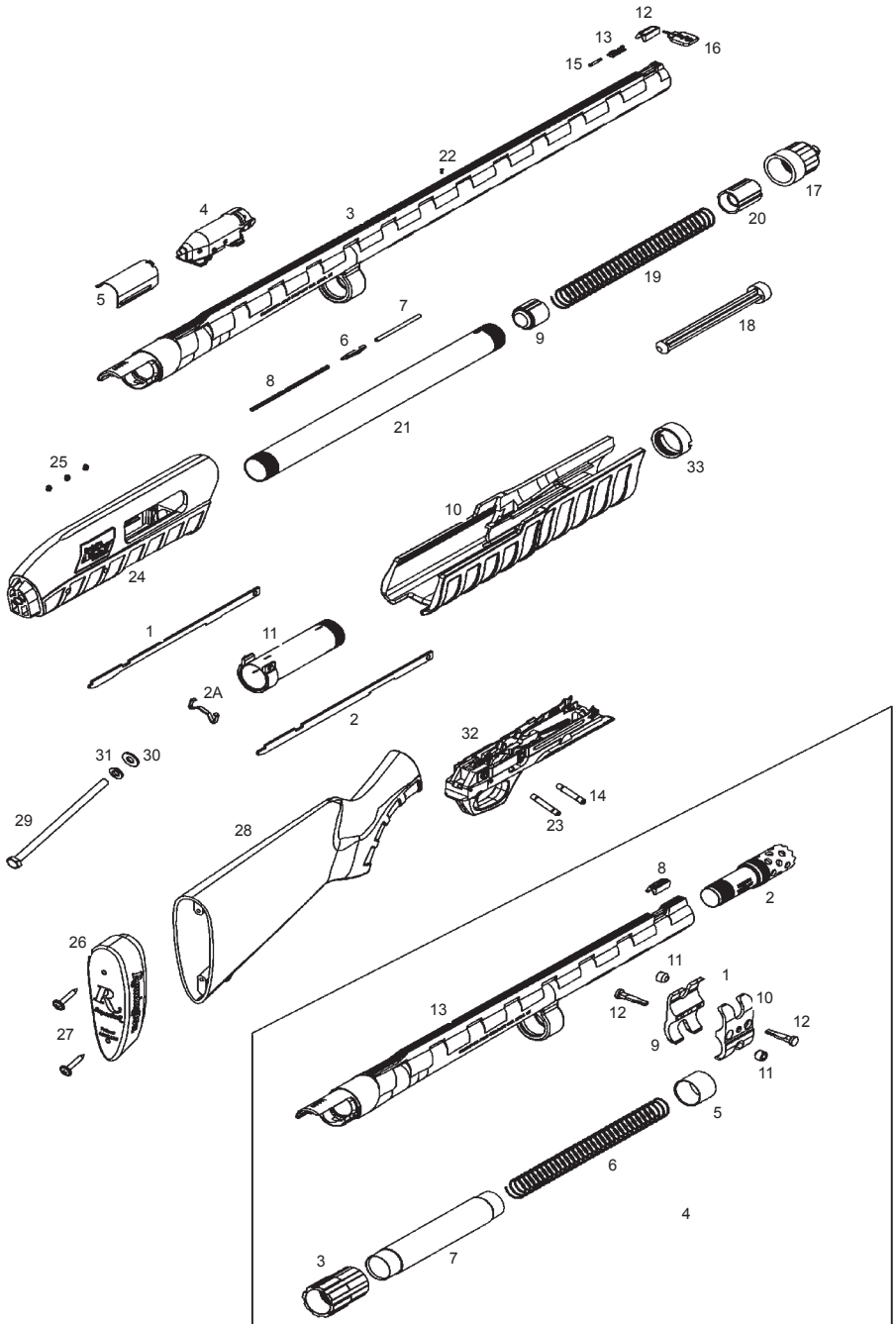

Drawing is provided for part identification only and should not be used as a guide to assemble the firearm.

# MODEL 887™ Nitro Magnum

## Pump Action Shotgun Parts List

Note: parts are subject to change without notice

ITEM NO.	PART NAME	ITEM NO.	PART NAME
1	Action Bar Left	17	Magazine Cap
2	Action Bar Right	18	Magazine Plug
2A	Action Bar Support	19	Magazine Spring
3	Barrel	20	Magazine Spring Retainer
4	Bolt Assembly	21	Magazine Tube
5	Ejection Port Cover	22	Mid Bead
6	Ejector	23	Rear Trigger Plate Pin
7	Ejector Retaining Pin	24	Receiver
8	Ejector Spring	25	Receiver Plugs
9	Follower	26	Recoil Pad
10	Fore End	27	Recoil Pad Screw (2)
11	Fore End Tube Assembly	28	Stock
12	Front Sight	29	Stock Attachment Bolt
13	Front Sight Base	30	Stock Attachment Washer
14	Front Trigger Plate Pin	31	Stock Lock Washer
15	Lite Pipe	32	Trigger Plate Assembly
16	Lite Pipe Key	33	Tube Nut; Fore-End

# MODEL 887™ Tactical

## Pump Action Shotgun Parts List

ITEM NO.	PART NAME	ITEM NO.	PART NAME
1	Barrel Clamp Assembly	8	Front Sight Assembly
2	Extended Choke; Ported	9	Left Barrel Clamp
3	Extension Barrel Nut	10	Right Barrel Clamp
4	Extension Magazine Assy	11	Slotted Nut; B. Clamp (2)
5	Extension Magazine Cap	12	Slotted Screw; B Clamp (2)
6	Extension Magazine Spring	13	Tactical Barrel 18"
7	Extension Magazine Tube		

# MODEL 887™ Nitro Magnum

## Pump Action Shotgun Exploded View

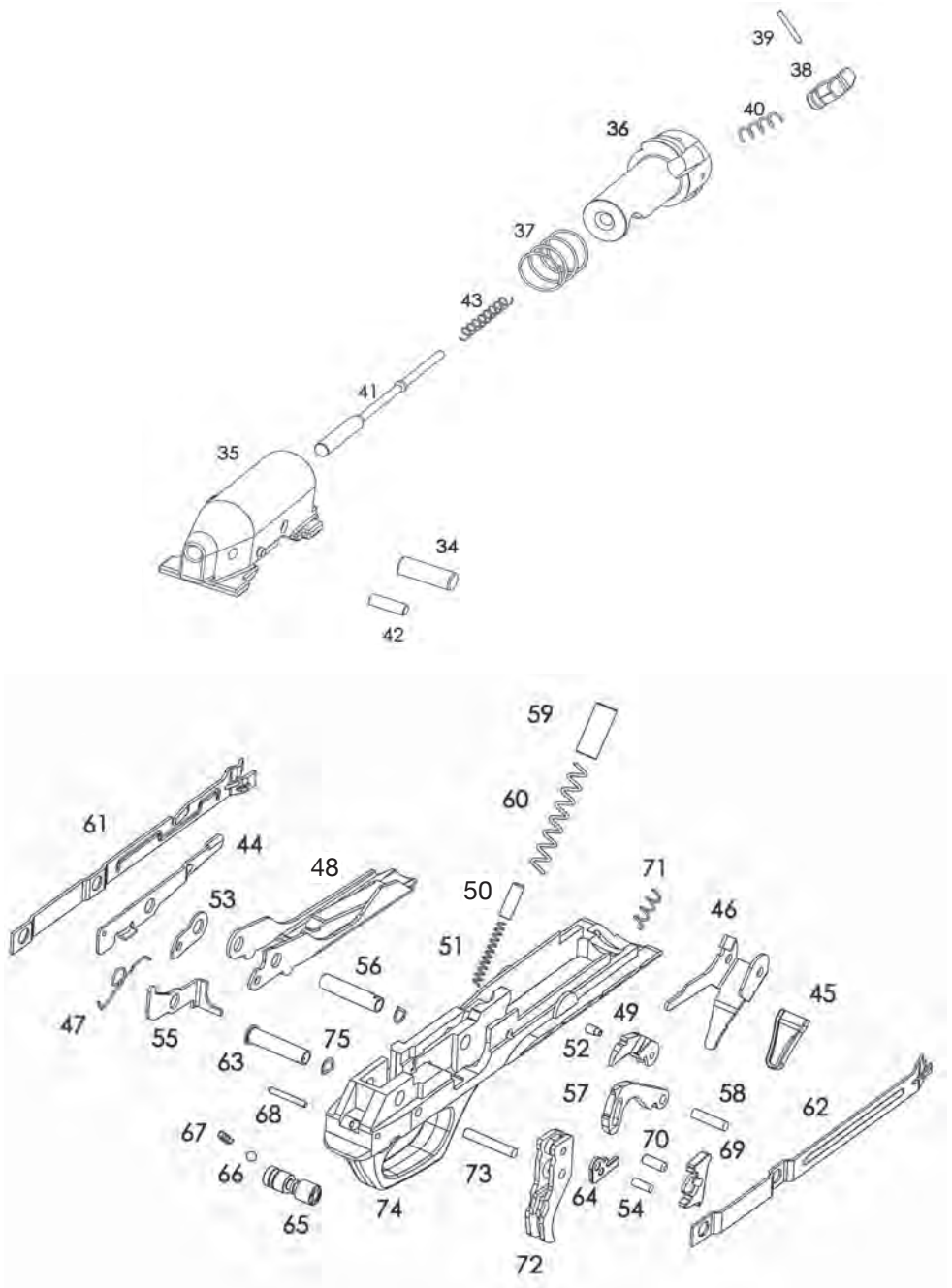

# MODEL 887™ Nitro Magnum

## Bolt and Trigger Plate Assembly Parts List

### Bolt Assembly (4)

ITEM NO.	PART NAME
34	Bolt Cam Pin
35	Bolt Carrier
36	Bolt Head
37	Bolt Head Bias Spring
38	Extractor
39	Extractor Retaining Pin
40	Extractor Spring
41	Firing Pin
42	Firing Pin Retaining Pin
43	Firing Pin Spring

### Trigger Plate Assembly (32)

ITEM NO.	PART NAME
44	Action Bar Lock
45	Action Bar Lock Release Button
46	Action Bar Lock Release
47	Action bar Lock Spring
48	Carrier
49	Carrier Dog
50	Carrier Dog Follower
51	Carrier Dog Follower Spring
52	Carrier Dog Pin
53	Carrier Dog Washer
54	Connector Pin
55	Disconnecter
56	Front Trigger Plate Bushing
57	Hammer
58	Hammer Pivot Pin
59	Hammer Plunger
60	Hammer Spring
61	Latch - Left
62	Latch - Right
63	Rear Trigger Plate Bushing
64	Right Connector
65	Safety Button
66	Safety Detent Ball
67	Safety Spring
68	Safety Spring Retaining Pin
69	Sear
70	Sear Pin
71	Sear Spring
72	Trigger
73	Trigger Pivot Pin
74	Trigger Plate
75	Trigger Plate Detent Spring

Note: parts are subject to change without notice.

## How to Obtain Parts and Service From Remington Arms Company, Inc.

### To Order Parts:

To order parts please visit Remington's web site @ [www.remingtonpartsstore.com](http://www.remingtonpartsstore.com) or call 1-800-243-9700. For additional information on service enhancements, upgrades, repair, additional barrels, and specialty parts visit [www.remington.com](http://www.remington.com).

To place an order or for additional information on service enhancements, up grades, and additional barrels, please call us toll free consumer service number, 1-800-243-9700, Mon.-Fri., 9:00 AM-5:00 PM Eastern time.

1. Fax completed order form (from the web site) to 1-336-548-7801.
2. To order by phone without the order form call 1-800-243-9700.

### Please have the following information ready before you call.

- Firearm model and serial number.
- Part description and quantity. Part descriptions can be found on the parts listing pages 24 through 27 in this manual.
- Your complete mailing address (P.O. Box and Street Address) including zip code, telephone number and e-mail address.
- Method of payment: MasterCard, Visa, Amex or Discover card number and expiration date. A quote may be made to you over the phone. (Sorry, no C.O.D.s.)

**WARNING!** Use only Remington parts in Remington's firearms.

**NOTE:** Some parts may be restricted. See parts list for details. Owner's manuals/ instruction books may be requested via our web site at: [www.remington.com](http://www.remington.com) or by calling 1-800-243-9700.

## Repair Services

If there is a defect with your Remington firearm that (i) you believe is, or should be, covered by the Warranty, (ii) you would like Remington to address at your cost and expense, or (iii) you would otherwise like to discuss with Remington, please contact Remington Consumer Services at 1-800-243-9700, Mon.-Fri 9:00AM – 5:00PM. Please do not send your firearm or other item to Remington without first (a) calling this number, (b) receiving instructions from the Remington representative, and (c) obtaining a Service Request document containing your Service Repair Number. With regards to the Service Request document, Remington will either e-mail this document to you or, if you do not have an e-mail address, Remington will mail it to you. Please be sure to store your Service Request document in your records so that it is both safe and accessible. Finally, to the extent you seek Warranty coverage, please review the Warranty for your Remington firearm and note that you may void your Warranty by taking action without first contacting Remington.

**WARNING! DO NOT SEND LIVE OR SPENT SHELLS IN YOUR FIREARM OR IN THE SAME BOX WITH THE FIREARM. THIS IS A VIOLATION OF FEDERAL LAW. IF YOU FEEL YOU MUST SEND SPENT SHELLS, PLEASE SEND THEM IN A SEPARATE PACKAGE AND INCLUDE NAME, ADDRESS (WITH ZIP CODE), TELEPHONE NUMBER, MODEL AND SERIAL NUMBER OF YOUR FIREARM.**



## Firearm Owner's Record

Model: \_\_\_\_\_

Serial # \_\_\_\_\_

Date Purchased: \_\_\_\_\_

Purchased From: \_\_\_\_\_

Price Paid: \_\_\_\_\_

Remember to complete and return the Firearm Warranty Registration Card in order to obtain full benefit of your Limited Two Year Firearm Warranty.

### **A WORD ON THE MAINTENANCE AND CARE OF YOUR REMINGTON FIREARM**

#### **Don't Alter or Modify Your Gun and Have it Serviced Regularly.**

*Your firearm* has been designed to operate according to certain factory specifications. You'll jeopardize your safety and that of others around you by attempting to alter its trigger, mechanical safety or other mechanisms. Never alter or modify your firearm in any way.

*Like any mechanical device*, a firearm is subject to wear. It must be maintained and periodically serviced to assure optimum safety and performance. Only a qualified service facility should service, repair or modify your Remington® firearm. Consult your instruction book for location of the nearest Remington repair station. Remington recommends that you have your

firearm professionally serviced annually. You should also have your firearm professionally serviced after prolonged storage, or if there is ever any question pertaining to the proper functioning characteristics of your firearm.

*Proper cleaning and lubrication* are also important to firearm maintenance and are necessary to assure accuracy, safety and reliability. Before cleaning, always make sure that your gun is completely unloaded. And always clean the barrel from the chamber end to the muzzle when possible.

## Firearm Maintenance Record

<b>DATE</b>	<b>Service</b>	<b>Performed By</b>

## NOTES

**MODEL 887™ Nitro Magnum  
Pump Action Shotgun**

*Remington.*®

REMINGTON IS A TRADEMARK REGISTERED IN THE UNITED STATES PATENT  
AND TRADEMARK OFFICE BY REMINGTON ARMS COMPANY, LLC

PRINTED IN THE U.S.A.

302011 12.08 ORIG. 08.13 REV