

MODEL VERSA MAX™
Autoloading Shotguns

Remington.

Remington is a Trademark Registered in the United States Patent and Trademark Office
By Remington Arms Company, LLC.

Printed in the U.S.A.

1914 06.13

Owner's Manual

Instruction Book for:
Remington®
VERSA MAX™
Autoloading Shotguns

IMPORTANT!

This manual contains operating, care, and maintenance instructions. To ensure safe operation, any user of this firearm must read and understand this manual before using the firearm. Failure to follow the instructions and heed the warnings in this manual can cause property damage, personal injury, and/or death.



This manual should always accompany this firearm, and be transferred with it upon change of ownership.

WARNING! Keep this firearm out of the reach of children, unauthorized individuals, and others unfamiliar with safe handling of firearms.

Remington®

Page 2	The Ten Commandments of Firearm Safety
Page 7	Important Parts of the Firearm
Page 11	To Assemble the Firearm
Page 11	To Load the Firearm
Page 14	To Unload the Firearm
Page 17	Lubrication and Maintenance
Page 22	To Function Test the Firearm
Page 27	Parts List
Page 30	How to Obtain Parts and Service



Remington®
VERSA MAX™

A Tradition of Performance and Safety.

In 1816 Eliphalet Remington was confident he could make a flintlock that was as good or better than any he could buy. His confidence was well founded. The barrel he handcrafted set a new standard for firearm accuracy and spawned generations of products that have made Remington® America's leading gun-maker. While performance and style are certainly hallmarks of Remington firearms, one factor ultimately drives their performance. Safety. Eliphalet Remington never lost sight of the fact that his rifles were potentially lethal and could kill someone if handled improperly. And after more than 190+ years the same holds true for any firearm, including your new Remington. Eliphalet Remington's first flintlock launched a proud tradition of accuracy and responsibility.



Eliphalet Remington's first flintstock launched a proud tradition of accuracy & responsibility

Safety is Critical to Performance.

A superbly crafted firearm is only as good as the hands that hold it. You can never be too careful. Shooting accidents are often caused by careless oversights such as failing to control the direction of the muzzle, failing to fully engage the safety, leaving ammunition in the chamber or using improper loads. These oversights can result in the destruction of life, limb or property. There's no calling back a bullet once it's been fired, so it's critical that you know the principles of safe firearm handling and storage before you ever take your new Remington firearm out of the box.

The proper use and performance of your firearm depends on correct assembly and maintenance, so it's critical that you familiarize yourself with the information in this instruction book. Even if you're a veteran shooter with a collection of Remington firearms, take the time to read this literature. Not all firearms are the same. That means the first step in safe handling is to learn the features and requirements of your new Remington.

THE TEN COMMANDMENTS OF FIREARM SAFETY

The Ten Commandments of Firearm Safety should be etched in your memory forever. Let them govern your action wherever and whenever you're involved with firearms. In the field. On the range. Or in your home. Please take the time to review and understand these rules.

1st C O M M A N D M E N T

ALWAYS KEEP THE MUZZLE POINTED IN A SAFE DIRECTION.

This is the most important firearm safety rule. A safe direction is one in which an accidental discharge will not cause injury to yourself or others. Never allow your firearm to point at anything you don't intend to shoot. Be especially careful when you're loading or unloading. Treat every firearm as if it were loaded. And make it a habit to know where the muzzle is pointed at all times, even when your firearm is un-loaded. No one will be injured by an accidental discharge if you keep your firearm pointed in a safe direction. It's as simple as that.

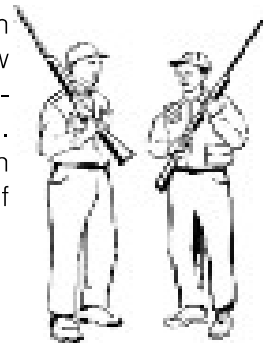

2nd C O M M A N D M E N T

Firearms should be Unloaded When Not Actually in Use.

Load your firearm only when you're in the field or on the target range and ready to fire. Never let a loaded firearm out of your sight or out of your hands. Unload it as soon as you're finished shooting - before you bring it into your car, camp or home. Remember, unloading your firearm means unloading it completely, so there is no ammunition in the chamber or in the magazine. Before handling a firearm or passing it to someone else, visually check the chamber, receiver and magazine to be certain they do not contain ammunition. Always keep the firearm's action open when not in use. Never assume a firearm is unloaded even if you were the last person to use it. Always check for yourself.

- *Let common sense rule* when you carry a loaded firearm. If you're in a situation that could risk accidental discharge - such as crossing a fence, wading through a stream or climbing a tree - always unload your firearm. Never pull or push a loaded firearm toward yourself or another person. Never carry a loaded firearm in a scabbard, detached holster or gun case.

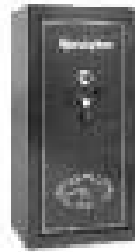

- *Certain firearms* (including some Remington® rifles and shotguns) are equipped with internal security devices to prevent unauthorized use. In addition, some firearms owners use external devices, such as cable locks and trigger blocks, for the same purpose. Even if you use such a device, you should still keep your firearm unloaded when stored or not in use. And using internal or external devices cannot substitute, however, for securing your firearms and ammunition in a separate, locked location.

Firearms should be stored in a secure place where children cannot access them. A gun safe is an ideal way to secure your firearm

- *Safe storage* of firearms is just as critical as safe handling. Never store firearms loaded. Be sure to keep your firearms in a secure place where unauthorized persons cannot get their hands on them without your knowledge.

- *Take special care* if there are children around. Children are fascinated by firearms. It's a natural curiosity that can have tragic consequences when not properly supervised. Store your firearms in a locked gun safe or some other location that physically bars a child from gaining access.

- *Ammunition* should be stored and locked in a location separate from your firearm. Never leave an unsecured firearm or ammunition in a closet, dresser drawer or under the bed. Remember, it is your responsibility to make sure that children and others unfamiliar with firearms cannot get access to your firearm and ammunition.

3rd C O M M A N D M E N T

DON'T RELY ON YOUR FIREARM'S SAFETY

Treat every Firearm as if it can fire at any time, whether or not there's pressure on the trigger. Your firearm has been carefully designed to maximize performance and safety. However, because a firearm's safety is a mechanical device, it could fail.

Human error is a more likely reason for a firearm safety to fail. By mistake, you may think the safety is on when it really isn't. Or the safety may have been disengaged without your knowledge. Or you could think your firearm is unloaded when there's actually a cartridge or shell in it. A mechanical safety is not a substitute for common sense. It's merely a supplement to your proper handling of a firearm.

Never touch the trigger on a firearm until you are ready to shoot. Keep your fingers away from the trigger when you're loading or unloading. And don't pull the trigger when the safety is engaged or positioned between safe and fire.

Before using your firearm, read this instruction book to understand the exact location and operation of your firearm's safety. Even when the safety is on, maintain control of your loaded firearm and control the direction of the muzzle. In other words, don't rely on your safety to justify careless handling. If your firearm's internal mechanisms are broken or have been altered, your firearm may fire even when the safety is on. Remember, you and your safe firearm handling practices are your firearm's best safety.

4th C O M M A N D M E N T

BE SURE OF YOUR TARGET AND WHAT'S BEYOND IT.



You can't stop a shot in mid-air, so never fire unless you know exactly where your shot is going and what it will strike. Never fire at a sound, a movement or a patch of color. A hunter in camouflage can easily be mistaken for a target by an impulsive shooter. Before you pull the trigger be absolutely sure of your target and what's behind it. Make sure the shot has a backstop such as a hillside or dense material like sand. Remember, bullets can travel great distances with tremendous velocity. Know how far your shot will go if you miss your target or the bullet ricochets.



5th C O M M A N D M E N T

Use Proper Ammunition

Every firearm is designed to use a certain caliber or gauge of ammunition. Using the wrong ammunition, mixing ammunition or using improperly reloaded ammunition can cause serious personal injury or death. And it only takes one cartridge or shotshell of the incorrect caliber or gauge, or which has been improperly reloaded, to destroy your firearm. It's your responsibility to make sure the ammunition you use exactly matches the caliber or gauge of your firearm. Refer to this instruction book to find out the specific requirements of your firearm. Always read and heed the instructions on ammunition boxes.

Confusing shells or cartridges can cause serious personal injury or death and destroy your firearm. Examine your shells or cartridges closely and use only the precise caliber or gauge for your specific firearm. For example, suppose you accidentally loaded a 20 ga. shell into a 12 ga. shotgun. Because the 20 ga. shell is too small for the chamber, the 20 ga. shell could travel down the barrel and get lodged in the bore. If you then loaded a standard 12 ga. shell behind it and fired, the 12 ga. shot will slam into the lodged 20 ga. shell and may cause the barrel to explode right in your hand. This is commonly called a 12/20 burst, and it can kill you.

Check all ammunition before you load it to make sure it matches your firearm's requirements. Every Remington® cartridge and shell is head-stamped with its caliber or gauge for easy identification. Likewise, you'll find the caliber or gauge of your new Remington firearm imprinted on the barrel.

Reloading Requires Extra Diligence.

If you're an ammunition reloader, you are responsible for personally ensuring that the loads and components of your reloaded ammunition meet your firearm's factory-tested standards. Never use ammunition, which has been reloaded by someone else!

Many shooters handload as a hobby or to save money on commercial, factory-made ammunition. However, it requires a thorough knowledge of reloading procedures and a deep respect for the explosive potential of gunpowder.

Firearms are designed, manufactured and proof-tested to standards based on factory-loaded ammunition. Handloaded or reloaded ammunition that deviates, either intentionally or accidentally, from load or component recommendations can be very dangerous.

Reloaders must observe all possible safety precautions and practices related to the proper handling of explosives. Whether you're a seasoned reloader or just starting out, you should study the subject, watch reloading demonstrations and talk to experienced reloaders.

The first rule of reloading is to always follow the manufacturer's instructions for the components you're using. They'll tell you to follow certain guidelines. Namely:

1. Don't mix or substitute powders or primers.
2. Don't use unknown or substandard components.
3. Use only suitable components that have been factory-tested by reputable ammunition, powder and bullet manufacturers.
4. Always be sure to use the manufacturer's recommended recipe when reloading.

Not following these guidelines could result in severe injury to yourself or severe damage to your firearm. Dangerously high pressure and explosions can result from an overcharge of powder or other deviations from established reloading guidelines. Be very careful. The process of reloading exposes you to environmentally hazardous material. Lead, which is known to cause cancer and birth defects, is the most common substance in bullets and shot. It is important to handle lead bullets and shot with extreme care. Work only in a well-ventilated area and always wash your hands after exposure and before eating. Never smoke while reloading.

Primers and powders are also highly toxic and flammable. So after reloading be sure to clean up all materials from your work area. Don't leave primer or powder spills anywhere on the floor or bench top. Dispose of all waste material in accordance with the manufacturer's recommendations.

Finally, when reloading or handloading concentrate on what you're doing at all times. Do not be distracted by talking to others, listening to the radio or watching TV while reloading. Never reload after consuming alcoholic beverages or drugs of any kind. You are working with extremely hazardous materials and you can't risk even a few seconds of distraction. Remember, if you reload, you are the ammunition manufacturer and you are responsible for the performance and safety of your reloaded ammunition.



6th C O M M A N D M E N T

IF YOUR FIREARM FAILS TO FIRE WHEN THE TRIGGER IS PULLED, HANDLE WITH CARE.

If for some reason the ammunition doesn't fire when you pull the trigger, stop and remember the 1st Commandment of Firearm Safety - always keep the muzzle pointed in a safe direction. Keep your face away from the breech, then put the safety on, carefully open the action, unload the firearm and dispose of the cartridge safely. Remember that anytime there's a shell in the chamber, your firearm is loaded and ready to use. Even if you tried to shoot and your firearm didn't fire, treat your firearm as if it could still discharge.



7th C O M M A N D M E N T

ALWAYS WEAR EYE AND EAR PROTECTION WHEN SHOOTING.

Your sight and hearing risk injury from shooting and should be protected at all times. Wear protective shooting glasses to guard against falling shot, clay target chips, powder residue, ruptured cartridge cases and even twigs and branches in the field. Also be sure to wear eye protection when you're disassembling or cleaning a firearm so that tensioned parts (like springs) and cleaning solvents don't come in contact with your eyes. Continued exposure to shooting noise can permanently damage your hearing. On the range, where shooting volume is the loudest, be sure to use the maximum protection of a head-set. Learn to use ear protection at all times.

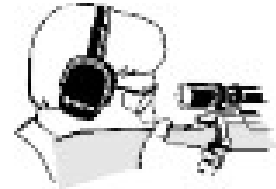

8th C O M M A N D M E N T

BE SURE THE BARREL IS CLEAR OF OBSTRUCTIONS BEFORE SHOOTING.

Before loading your firearm, open the action and make sure there's no ammunition in the chamber or magazine. Check the barrel for any obstructions or debris. Even a small amount of snow, mud, excess lubricant or grease in the bore can dangerously increase pressure and cause the barrel to bulge or burst when firing. Use a cleaning rod and patch to wipe away anti-rust compounds or any other residues or obstructions in the barrel. Never try to shoot out an obstruction by loading another shell and firing!

When firing, rely on your instincts. If the noise or recoil of your firearm seems weak, stop everything, unload your firearm and be sure nothing is lodged in the barrel. Remember the 12/20 burst? That's what can happen when the barrel is obstructed. Always be sure you're using the correct ammunition in your firearm and that it's free of obstructions.



9th C O M M A N D M E N T

DON'T ALTER OR MODIFY YOUR FIREARM AND HAVE IT SERVICED REGULARLY.

Your firearm has been designed to operate according to certain factory specifications. You'll jeopardize your safety and that of others around you by attempting to alter its trigger, mechanical safety or other mechanisms. So never alter or modify your firearm in any way.



Like any mechanical device, a firearm is subject to wear. It must be maintained and periodically serviced to assure optimum safety and performance. Only a qualified service facility should service, repair or modify your Remington firearm. Consult your instruction book for instructions on how to send your firearm to the factory or for the location of the nearest Remington authorized repair station.

Proper cleaning and lubrication are also important to firearm maintenance and are necessary to assure accuracy, safety and reliability. Before cleaning, always make sure that your firearm is completely unloaded. And always clean the barrel from the chamber end to the muzzle when possible.

Make it a practice to clean your bore every time you're going to shoot. Be sure to clean your entire firearm before and after long-term storage and no less than once a year. It's also important to clean your firearm whenever it's been exposed to adverse conditions such as rain, dirt, mud, snow, sleet or salt-water.

For safe and dependable operation of your firearm, all parts of your firearm must be properly cleaned and lubricated. Periodically inspect the internal workings of your firearm to be sure they're clean and free of rust, unwanted dirt and debris.

Use recommended lubricants on your firearm and do not over-lubricate. Excessive use of a non-recommended lubricant could adversely affect the function and safe operation of your firearm. Remember, you are responsible for the proper care and maintenance of your firearm. Failure to properly maintain your firearm cannot only damage or ruin your firearm, it can expose you and others to unnecessary risks of personal injury or death.

Remington® has a wide range of firearm care products and resources for best results when cleaning your firearm. Everything from solvents and lubricants to rods and patches. They're all available from your Remington dealer.



10th C O M M A N D M E N T

LEARN THE MECHANICS AND HANDLING CHARACTERISTICS OF YOUR FIREARM.

Not all firearms are alike. They have different mechanical characteristics that dictate how you should carry and handle them. Anyone who plans to use a firearm should first become totally familiar with the type of firearm it is and the safe handling procedures for loading, unloading, carrying, shooting and storing it.

Before you even unpack your new Remington firearm, read this instruction book from cover to cover and familiarize yourself with the different component parts of the firearm. Then read, understand and follow the Ten Commandments of Firearm Safety in this manual.

WARNING! Discharging firearms in poorly ventilated areas, cleaning firearms or handling ammunition may result in exposure to lead, a substance known to cause birth defects, reproductive harm, cancer and other serious physical injury. Have adequate ventilation at all times. Wash hands thoroughly after exposure.



SHOOT SOBER!!

There's one other rule that must be followed when handling firearms. In fact, respect for this rule is necessary in order to effectively practice the Ten Commandments of Firearm Safety. The rule is: SHOOT SOBER! Firearms and alcohol or drugs make a deadly combination. Never consume anything that would mildly impair your judgment or physical coordination when you're using a firearm. A staggering percentage of the shooting accidents that occur every year involve alcohol or drugs. Be smart. Always shoot sober and stay alive.

WARNING! Failure to follow any of these safety rules may cause personal injury or death to the shooter or bystander and damage to property. Do not use a firearm until you fully understand and practice the Ten Commandments of Firearm Safety. If you have any questions about the safe use of a Remington firearm, write to us at Remington Arms Company, LLC., Consumer Service, P.O. Box 700, Madison, NC 27025-0700, or call us at 1-800-243-9700.

DON'T KEEP THIS TO YOURSELF.

Now that you're a firearm owner you have the obligation to help ensure that shooting sports are safe for everyone - participants and bystanders alike. You can do that by practicing these principles of firearm safety and passing them on to others - especially new shooters. Set an example for beginners. Be a guide to their safe entry into the exciting world of shooting sports. Invest your time and patience for the love of the sport and for its future. After all, it's your love of the sport that led you to buy a new Remington.

Firearm ownership is a right and privilege. It's a right guaranteed in this nation's Constitution. It's a privilege, which carries with it a personal responsibility to use your firearm in a way which will ensure your safety and the safety of others. The preservation of this right and privilege depends on the personal commitment of you and your fellow shooters to the safe and responsible use of firearms. Let the Ten Commandments of Firearm Safety outlined in the manual guide you at all times. Teach and promote these rules whenever you can. Remember, firearm safety depends on you! That's the only way to really enjoy your new Remington firearm and to preserve sport shooting as we know it today.

Remington® VERSA MAX™ Autoloading Shotguns

Congratulations on your choice of a Remington®. With proper care, it should give you many years of dependable use and enjoyment. For best results, we recommend that you use Remington Ammunition - the ammunition used in factory testing your firearm against our rigorous function and performance standards.

PICTURE 1 This picture shows the main parts of the REMINGTON® Versa Max Autoloading Shotgun. The picture will aid in understanding the instructions.

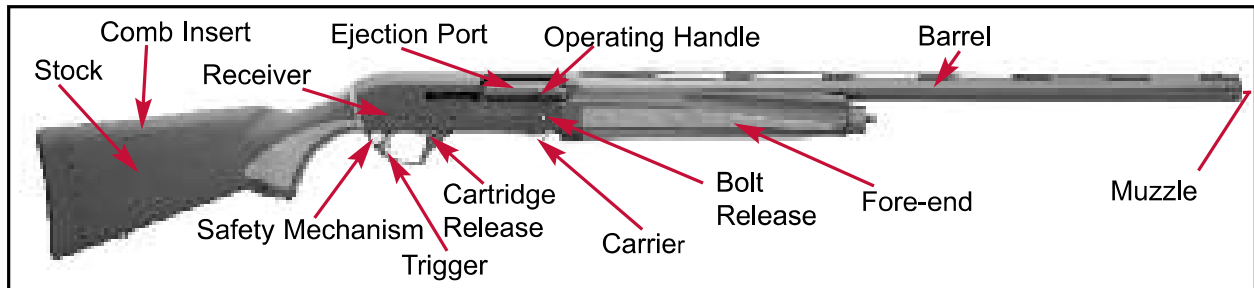

Important Parts of the Firearm

General Operation

The Remington® VERSA MAX™ is a gas operated, autoloading shotgun. The firearm is capable of firing successive shots with 2 3/4, 3, and 3 1/2 inch shot-shell cartridges interchangeably. At the start of the firing cycle when the trigger is pulled, the disconnecter is activated and the hammer is released, striking the firing pin. In turn, the firing pin strikes the chambered shotshell's primer, igniting the shot charge. High pressure gas from behind the shot charge passes through ports in the barrel to the gas cylinders. The residual gas pressure forces the bolt assembly rearward, operating the action. The spent shell is extracted from the chamber. The hammer is re-cocked. The disconnecter is deactivated when the trigger is released. The trigger and cartridge release are reset. As the action continues rearward the spent shell engages the ejector, expelling it from the receiver through the ejection port. When the bolt is fully rearward, a new shotshell is released from the magazine onto the carrier. As the bolt moves forward the carrier rises to place the new shell in front of the bolt. Completing the cycle, the bolt continues forward pushing the shell into the chamber. The bolt head rotates, locking the cartridge into battery (firing position). When the last shell has been discharged, the bolt assembly locks in the open position.

Caution: The Versa Max manual bolt hold open, loading, and unloading procedures are not the same as a Remington 1100 or 11-87 autoloading shotgun. See "To Load the Firearm" and "To Unload the Firearm", sections of this manual.

Serial Number and Cartridge Designation:

The serial number is located on the shooter's right side of the receiver. See Picture 2.

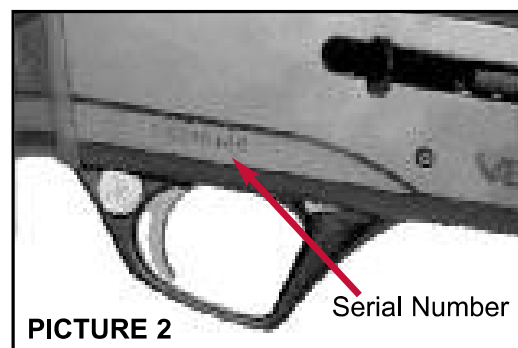

Specifications for the correct gauge and length of the shotshell intended for use in your firearm is located on the shooter's left side of the barrel. See Picture 3.

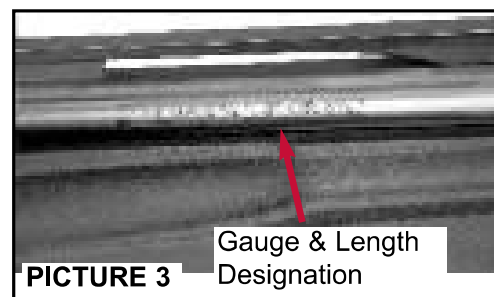

WARNING! Only use the specified gauge and length of shotshell ammunition specified for your firearm as designated on the barrel. See "To Load the Firearm," page 11.

The Safety Mechanism

The manual safety mechanism on the Versa Max shotgun provides protection against accidental or unintentional discharge under normal usage when properly engaged and in good working order. This safety mechanism is not a substitute for following the rules of safe firearm handling. The cross bolt type safety prevents the trigger from being pulled when fully engaged in the "ON" or "SAFE" position. To engage the safety mechanism, push the "Safety Button," located at the rear of the trigger guard, to the shooter's right until the button stops and **THE RED BAND MARKING CANNOT BE SEEN.** See Picture 4.

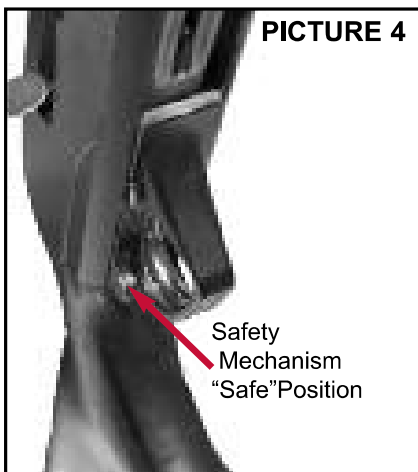

Always engage the safety mechanism by moving the safety button to the shooter's right before handling, loading or unloading the firearm.

*When you are ready to FIRE the firearm, disengage the Safety Mechanism by pushing the Safety Button to the shooter's left until the button stops and the **RED BAND MARKING IS VISIBLE.** See Picture 5. You have now disengaged the Safety Mechanism and the firearm is ready to FIRE.*

Do not touch the trigger while moving the safety mechanism. Your fingers and all other objects should be kept outside of the trigger guard and away from the trigger until you are actually ready to FIRE.

Never pull the trigger when the Safety Mechanism is in the "ON" or "SAFE" position.

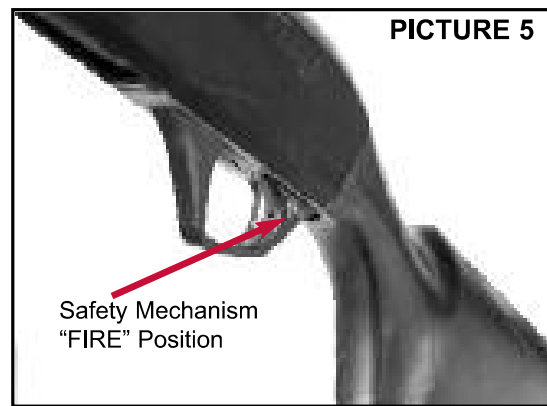

WARNING! The firearm will discharge when the trigger is pulled and the *safety mechanism* is OFF or in the "FIRE" position.

*Even when the safety is engaged in the "ON" or "SAFE" position, careless handling can cause the firearm to discharge. See *The Third Commandment of Firearm Safety.**

NOTE: If desired, a left-handed shooter may have the operation of the safety mechanism reversed by the factory or a Remington® Authorized Repair Center. Once reversed to accommodate a left-handed shooter, the safety mechanism's "ON" and "OFF" positions will be exactly opposite as described in this manual.

Additional Features:

Besides the manual safety mechanism, the Versa Max autoloading shotguns incorporate passive features providing additional protection against accidental or unintentional discharge under normal usage and in good working order. These passive features such as the inertia firing pin system, steel alloys and/or their metallurgical treatments, the hammer, sear, and trigger engagements, the trigger disconnect, the breech lock-up system, head space, and the trigger guard all work without direct input from the user as long as your firearm is kept clean and in good working order.

WARNING! Do not alter, modify, bypass, or render these safety features inoperative.

The Locking Device

This firearm was originally sold with a key-operated locking device to assist the owner in protecting against unauthorized use. These are storage locking devices, which should be used when the firearm is stored or not in use. Always store a firearm completely unloaded.

These locking devices **DO NOT** eliminate the need for safe firearm handling and storage, including keeping this and every firearm unloaded and locked in a secure place when not in use. Read and follow these and other safety rules in this instruction manual. Failure to read, understand, and obey these rules can result in serious personal injury or death. See the "Ten Commandments of Firearm Safety," on page 2.

Keep your locking device engaged when your firearm is not in use. Keep the keys in a secure place, inaccessible to others. DO NOT leave your keys or any ammunition with your firearm, which should be kept locked in a safe place.

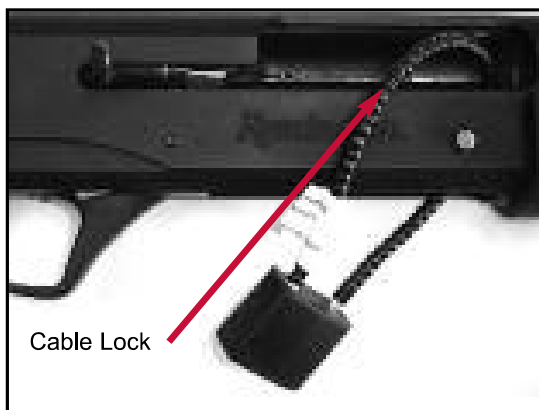
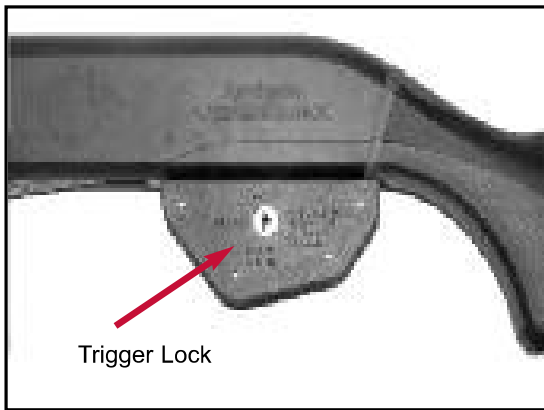

To secure your firearm with an external locking device, See instructions provided in the packaging.

The Operating Handle, Bolt Release, and Cartridge Release

The operating handle is used to move the bolt rearward, opening the action. The bolt release is used to release the bolt from the locked open position. See Picture 6.

The cartridge release is used to manually release cartridges from the magazine and to manually reset the bolt lock open feature.

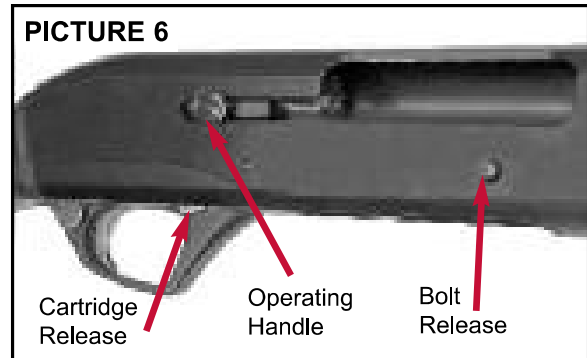

WARNING! When the operating handle (bolt) is forward in the closed position and the safety mechanism is in the "OFF" or in the "FIRE" position, the firearm can be discharged by pulling the trigger.

The Trigger Assembly

Pulling the trigger FIRES the firearm.

The trigger assembly of your Versa Max shotgun is a single-action (SA) system. When the trigger is pulled fully rearward, it starts the firing sequence by releasing the hammer. The trigger assembly is not adjustable. All repairs to the trigger assembly must be made by the factory or a Remington Authorized Repair Center.



WARNING! Never place your finger on the trigger unless you are ready to discharge or fire the firearm.

WARNING! Never manipulate, adjust or change any of the internal components of your firearm. Improper manipulation of any internal component may effect the safety and reliability of your firearm and may cause serious injury or death.

The Choke Tube

The inside bore constriction at the muzzle end of a shotgun's barrel is known as the "Choke". When a shot shell is discharged, shot travels down the bore, exiting the muzzle and begins to "spread-out". The spread of the shot is controlled by changing the muzzle constriction. The Versa Max has a changeable, screw-in, choke tube system. To change or replace the barrel's choke tube, see: "To Change the Choke Tube," on page 14. For more information about choke tubes, see: *The Remington Guide to Shotguns and Shot Shell Ammunition*, publication or visit our web site at www.remington.com.

WARNING! Unload your shotgun before removing or installing a choke tube and the safety mechanism is engaged by placing the safety in the "ON" or "SAFE" position

WARNING! Never discharge your shotgun without a choke tube properly installed, as damage or injury may occur.

WARNING! Never discharge steel shot through a lead only choke tube. Choke tubes **NOT** designated for steel will be marked "Lead Only".

The Magazine Plug

A magazine plug is provided with your shotgun to limit the magazine capacity to two (2) shot shells. A limited magazine capacity limit is required by the Federal Migratory Bird regulations and certain state laws. Check with your local Fish & Game Commission or other appropriate authorities to determine whether a magazine plug is required to limit the magazine capacity within your jurisdiction.

To install or remove a magazine plug, See: "To Install the Magazine Plug," on page 14.

WARNING! Before installing or removing a magazine plug, make sure the firearm is completely unloaded and the safety mechanism is engaged by placing the safety in the "ON" or "SAFE" position.

The Barrel

WARNING! The inside of the barrel and chamber must be clean and free of obstructions. See the "Ten Commandments of Firearm Safety," on page 2.

I. To Check the Barrel for Obstructions:

1. Always keep the firearm pointed in a safe direction.
2. Engage the safety mechanism in the "ON" or "SAFE" position. The red band will NOT be visible.
3. Engage the bolt hold open by pressing the cartridge release fully upward. See Picture 6.
4. Open the bolt by pulling the operating handle fully rearward, locking the bolt in the open position.
5. Visually check the chamber, loading port and magazine to make sure the firearm is completely unloaded.
6. Insert a cleaning rod into the muzzle.
7. Push the rod completely through the barrel until the rod can be seen at the ejection and loading port.

II. To Remove a Barrel Obstruction:

WARNING! NEVER try to remove an object from the barrel by loading a shotshell (cartridge) and firing. This may cause the barrel to burst or a shotshell to rupture and cause serious personal injury or death.

1. Always keep the firearm pointed in a safe direction.
2. Engage the safety mechanism in the "ON" or "SAFE" position. The red band will NOT be visible.
3. Engage the bolt hold open by pressing the cartridge release fully upward. See Picture 6.
4. Open the bolt by pulling the operating handle fully rearward, locking the bolt in the open position.
5. Visually check the chamber, loading port, and magazine to make sure the shotgun is completely unloaded.
6. Remove the barrel. See "To Disassemble the Firearm for Cleaning," on Page 18.
7. Insert the cleaning rod of the correct bore size into the muzzle and lightly tap the rod to free object from the barrel.

8. Push the rod all the way through the barrel until the rod can be seen at the ejection and loading port.
9. If an object cannot be easily pushed out of the barrel with a cleaning rod, return the barrel to the factory or a Remington Authorized Repair Center.

To Assemble the Firearm:

The firearm was shipped with the barrel assembly removed. See Picture 7 for location of parts.

Note: The bore and chamber must be

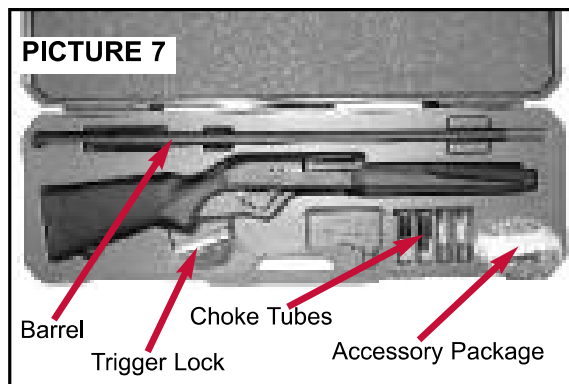

cleaned before assembly. See "To Clean the Barrel," on Page 19.

1. Always keep the firearm pointed in a safe direction.
2. Engage the safety mechanism in the "ON" or "Safe" position by moving the safety button fully to the shooter's right. The red band will NOT be visible.
3. Visually check the barrel making sure there are no obstructions.
4. Unscrew and remove the magazine cap by turning it counterclockwise.
5. Remove the fore-end from the magazine tube by sliding it forward.
6. Reset the bolt hold open by pressing the cartridge release. See Picture 6.
7. Open the bolt by pulling the operating handle rearward until the bolt locks in the open position.
8. Insert the barrel into the receiver and the barrel ring over the magazine tube. See Picture 8.
9. Place the fore-end over the magazine tube until it seats against the receiver.
10. Replace the magazine cap on top of the magazine tube. Tighten by turning clockwise until hand-tight.

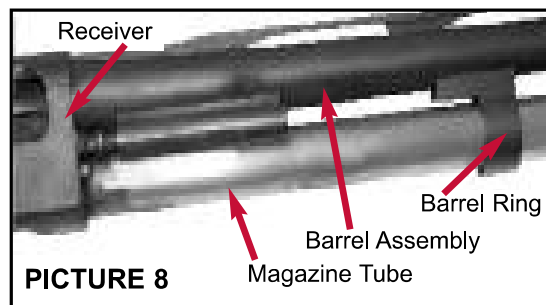

To Load and Unload the Firearm

To Load the Firearm:

WARNING! The specific gauge and length of shotshell ammunition suitable for use in your shotgun is marked on the barrel. Different gauges and shell lengths are not interchangeable. **DO NOT** use any ammunition other than the designated gauge and length specified for your shotgun. Using incorrect ammunition in your firearm can result in a severe malfunction of your firearm or ammunition, leading to personal injury and/or death. See "The Ten Commandments of Firearm Safety," on page 2.

Ammunition:

The VERSA MAX™ shotgun is designed to function with 2 3/4, 3, or 3 1/2 inch, ammunition. If you experience any initial cycling problems with certain loads, we recommend firing a number of cartridges of standard game loads to speed the break-in of your new shotgun.

Always check the cartridge for the correct gauge and length before loading the firearm. To find additional ammunition information, see the Remington catalog or visit the Remington website at www.remington.com.

WARNING! Do not apply oil, grease, or any lubricants to cartridges.

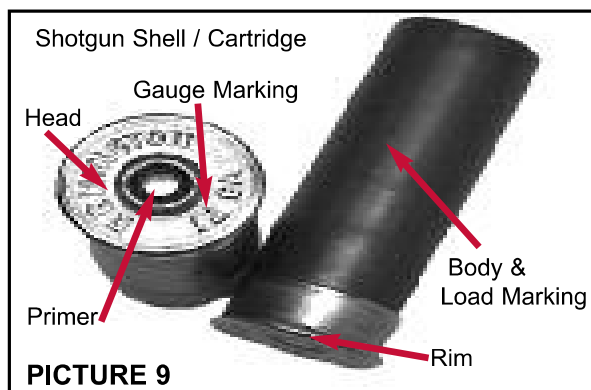

To Fully Load the Firearm:

WARNING! Always check the cartridge for the correct designation before loading the firearm.

Caution: The bore should be cleaned before loading the firearm the first time. Follow the cleaning instructions shown on Page 19, "To Clean the Barrel."

1. Always keep the firearm pointed in a safe direction.
2. Engage the safety mechanism in the "ON" or "Safe" position by moving the safety button fully to the shooter's right. The red band will NOT be visible.
3. Engage the bolt hold open by pressing the cartridge release upward. See Picture 6.
4. Pull the operating handle fully rearward to lock the bolt in the open position.
5. With the bolt locked open, visually check the chamber, loading port, and magazine making sure the firearm is completely unloaded. If the chamber is not unloaded, see page 14, "To Unload the Firearm."
6. Make sure the barrel and chamber are free of obstructions, see page 10, "To Check the Barrel for Obstructions."

I. To Load the Chamber:

7. Place one shell onto the carrier through the ejection port. See Picture 10.

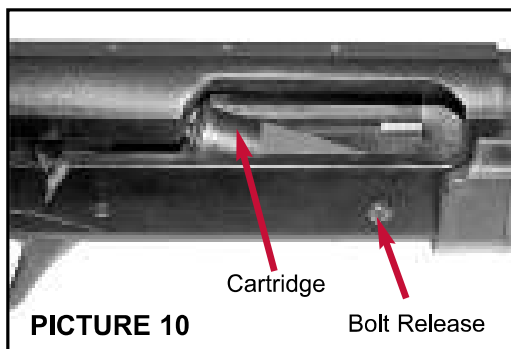

8. Close the bolt assembly by pressing the Bolt Release, chambering the cartridge.

WARNING! When releasing the bolt, keep hands, clothing and other objects away from the bolt and bolt handle.

II. To Load the Magazine:

9. Push up to three (3) 2 3/4" or 3" cartridges or two (2) 3 1/2" cartridges of the correct gauge, one at a time, fully forward into the magazine tube (see Picture 11), ensuring the rim of each shell engages the feed latch and is held inside the magazine tube. See Picture 12.

WARNING! The firearm is now cocked

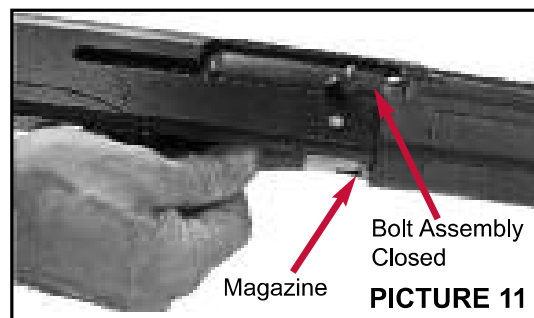

and fully loaded. Make sure the safety mechanism is still engaged in the "ON" or "SAFE" position. Always keep the firearm pointed in a safe direction.

To Load the Chamber From the Magazine:

Note: The bolt must be fully forward and the hammer must be cocked before the magazine can be loaded.

1. Always keep the firearm pointed in a safe direction.
2. Engage the safety mechanism in the "ON" or "Safe" position by moving the safety button fully to the shooter's right. The red band will NOT be visible.
3. Engage the bolt hold open by pressing the cartridge release. See Picture 6.
4. Pull the operating handle fully rearward to lock the bolt in the open position.
5. With the bolt locked open, visually check the chamber, loading port, and magazine making sure the shotgun is completely unloaded.
6. Make sure the barrel and chamber are free of obstructions, see page 10, "To Check the Barrel for Obstructions."

WARNING! When loading, keep hands, clothing and other objects away from the bolt and bolt handle.

7. Close the bolt assembly by pressing the Bolt Release.
8. Push up to three (3) 2 3/4" or 3" cartridges or two (2) 3 1/2" cartridges of the correct gauge, one at a time, fully forward into the magazine tube, ensuring the rim of each shell engages the feed latch and is held inside the magazine tube. See Picture 12.

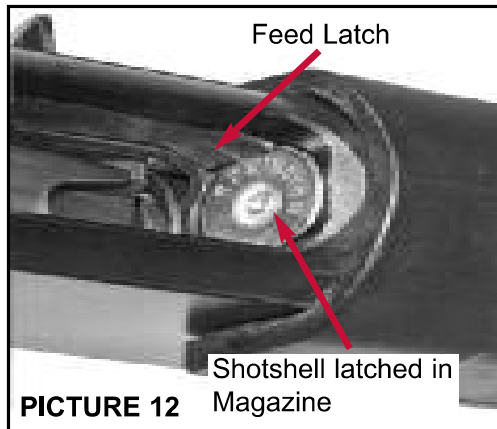

9. Release a shotshell from the magazine onto the carrier by pressing the Cartridge Release lever. See Picture 6.
10. Pull the operating handle fully rearward then release, chambering the staged round.

WARNING! The shotgun is now cocked and fully loaded. Make sure the safety mechanism is still engaged in the "ON" or "SAFE" position. Always keep the firearm pointed in a safe direction.

How to Change a Chambered Cartridge without Feeding a Cartridge from the Magazine (cut-off)

1. Always keep the firearm pointed in a safe direction.
2. Engage the safety mechanism in the "ON" or "SAFE" position. The red band will NOT be visible.
3. Pull the operating handle rearward, extracting and ejecting the chambered cartridge.
4. While holding the operating handle rearward, drop a cartridge onto the carrier through the ejection port. See Picture 13.
5. Chamber (load) the staged cartridge by releasing the operating handle.

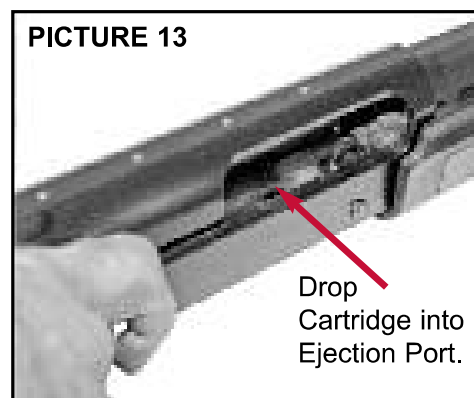

To Discharge the Firearm:

WARNING! Always wear eye and hearing protection when discharging your firearm. See "The Ten Commandments of Firearm Safety," on page 2.



1. Point the muzzle at your intended target.
2. Disengage the safety mechanism by moving the safety button to the "OFF" or "FIRE" position. The red band will be visible.
3. With target acquired and the butt of the shotgun firmly mounted against your shoulder, pull the trigger. The firearm will discharge each time the trigger is pulled until the magazine and chamber are empty. The bolt will remain **Open** when the last shell has been discharged.

WARNING! If a cartridge does not discharge when the trigger is pulled (misfire), keep the firearm pointed in a safe direction and wait one minute before opening the bolt. See: "To Unload the Firearm," on page 14.

WARNING! If the "report" of the shot is noticeably softer or louder or any way irregular, keep the firearm pointed in a safe direction; unload the firearm and check for bore obstructions. See: "To Remove a Barrel Obstruction," on page 10.

4. Engage the safety mechanism in the "ON" or "Safe" position by moving the safety button fully to the shooter's right. The red band will NOT be visible.
5. With the bolt locked open, visually check the chamber, loading port, and magazine to make sure the firearm is completely unloaded.

To Unload the Firearm

WARNING! NEVER assume your firearm is unloaded to justify careless handling. Always control the direction of the muzzle of your firearm, even if you think it is completely unloaded.

1. Always keep the firearm pointed in a safe direction throughout the unloading process.
2. Engage the safety mechanism in the "ON" or "Safe" position by moving the safety button fully to the shooter's right. The red band will NOT be visible.
3. Release a shotshell from the magazine onto the carrier by pressing the Cartridge Release lever. See Picture 6.
4. Pull the operating handle fully rearward, extracting the chambered cartridge.
5. Chamber (load) the staged cartridge by releasing the bolt.
6. Repeat steps 3 thru 5 until all cartridges are removed from the firearm. When all cartridges are removed from the firearm, the bolt will remain open in the locked position.
7. With the bolt locked open, visually check the chamber, loading port, and magazine to make sure the firearm is completely unloaded and free of obstructions.

To Change the Choke Tube:

WARNING! Completely unload the firearm before changing the choke tube. See "To Unload the Firearm," page 14.

1. Always keep the firearm pointed in a safe direction.
2. Engage the safety mechanism in the "ON" or "Safe" position by moving the safety button fully to the shooter's right. The red band will NOT be visible.
3. Engage the bolt hold open by pressing the cartridge release. See Picture 6.
4. Pull the operating handle fully rearward to lock the bolt in the open position.
5. With the bolt locked open, visually check the chamber, loading port, and magazine to make sure the firearm is completely unloaded. If the firearm is not unloaded, See "To Unload the Firearm," page 14.

6. Place the choke tube wrench supplied with your shotgun into the choke tube. See Picture 14.

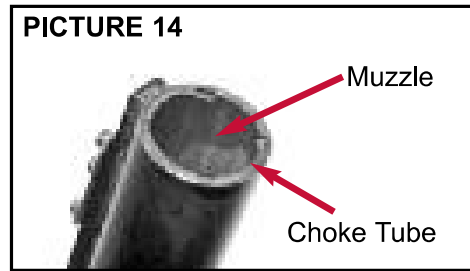

7. Turn the choke tube wrench counterclockwise until the choke tube can be removed from the barrel.
8. Select the desired choke tube and insert it into the barrel muzzle.
9. Place the choke tube wrench onto choke tube and tighten by turning clockwise. **Do Not Over Tighten!**
10. Remove choke tube wrench.
11. With the Safety in the "ON" or "SAFE" position, bolt open, and the chamber and magazine completely unloaded, check the choke tube periodically to make sure it is tight and secure.

CAUTION: Never discharge the shotgun without a choke tube properly installed. After installing a choke tube, ensure the choke tube wrench has been removed.

To Install the Magazine Plug:

WARNING! Check with you local Fish & Game Commission or other appropriate authorities to determine whether a magazine plug is required in your jurisdiction.

1. Always keep the firearm pointed in a safe direction.
2. Engage the safety mechanism in the "ON" or "Safe" position by moving the safety button fully to the shooter's right. The red band will NOT be visible.
3. Completely unload the chamber and magazine. See "To Unload the Firearm," on page 14.
4. With bolt locked open, visually recheck the chamber, loading port, and magazine, making sure the shotgun is completely unloaded.
5. Ensure the barrel and chamber are free of obstructions, see page 10, "To Check the Barrel for Obstructions."
6. Remove the magazine cap by turning it counterclockwise.
7. If required, place the choke tube wrench onto the magazine spring retainer.

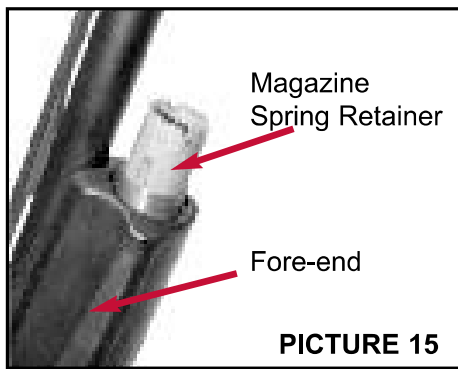

8.

Push down on the choke tube wrench and retainer (approximately one half (1/2) inch or until you can turn the Magazine Spring Retainer clockwise.

WARNING! Use extreme care when removing the magazine spring retainer, as the magazine spring is under compression. Wear eye protection to avoid serious personal injury.

9. Turn the Magazine Retainer approximately 1/4 turn. Slowly release the magazine spring and retainer as it is under pressure. Remove the magazine spring retainer. Do not remove the magazine spring.
10. With the magazine spring in the magazine tube, place the magazine plug into the center of the magazine spring.
11. Place the open end (end without teeth) of the magazine spring retainer on top of magazine spring.
12. Push the magazine spring, plug, and retainer into the magazine tube while aligning the magazine retainer detent slots with the detents in the magazine tube. See Picture 16.

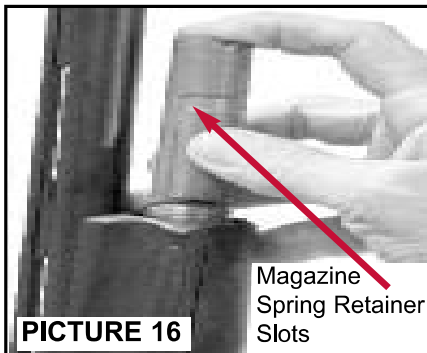

13. Once the detents are aligned, push the magazine spring, plug, and retainer down into the magazine tube (approximately 1 1/2 inch) until the magazine retainer can be turned 1/4 of a turn, locking the retainer in position.

14. If used, carefully remove the choke tube wrench from the magazine retainer.
15. Replace the magazine cap by turning clockwise until tight. Do not over tighten.

Sights:

WARNING! Before adjusting the sights or mounting any telescopic sights, make sure the firearm is completely unloaded and the safety mechanism is engaged by placing the safety in the "ON" or "SAFE" position.

See instructions provided in packaging to change the front sight's fiber optic (lite-pipe).

Receiver Mounted Optics:

The top of the Versa Max receiver is drilled and tapped for an optic sight mount (not provided). For optic mounting and adjustment see the instructions provided with your optic sight system.

The Stock Adjustments:

I. To Change the Length of Pull:

The Versa Max is provided with spacers to change the Length-Of-Pull (LOP). The LOP may be adjusted from 14 1/4 to 15 1/4 inches. To install and adjust the LOP, see the LOP instructions provided with packaging.

II. The Drop at Comb Insert:

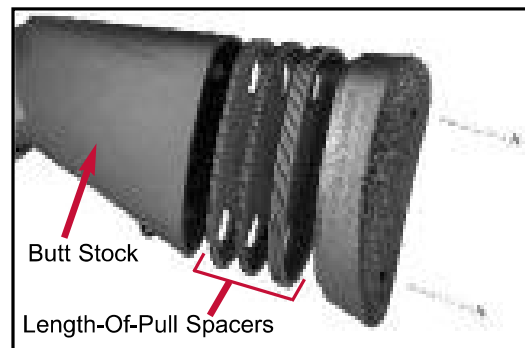

The Versa Max stock is designed to allow easy height adjustment of the drop at the comb from 1 7/16" (standard), 1 7/8" and 2 1/8" by changing the comb insert. Order additional comb inserts through your Remington Dealer. See mounting instructions provided with your comb insert packaging.

	Cast Plate Mounting Hole	Drop at Heel	Drop at Comb	Cast Left	Cast Right
5 Hole Cast Plate "A"	TL (Top Left)	2 1/2	1 9/16	--	1/4
	TR (Top Right)	2 1/2	1 9/16	1/4	--
	CC (Center Center)	2 1/4	1 1/2	--	--
	BL (Bottom Left)	2	1 7/16	--	1/4
	BR (Bottom Right)	2	1 7/16	1/4	--
3 Hole Cast Plate "B"	TC (Top Center)	2 1/2	1 9/16	--	--
	CR (Center Right)	2 1/4	1 1/2	1/4	--
	CL (Center Left)	2 1/4	1 1/2	--	1/4
	BC (Bottom Center)	2	1 7/16	--	--

Chart 1

Note: Drop at comb measurements are shown with the standard (1 7/16") Comb Insert.

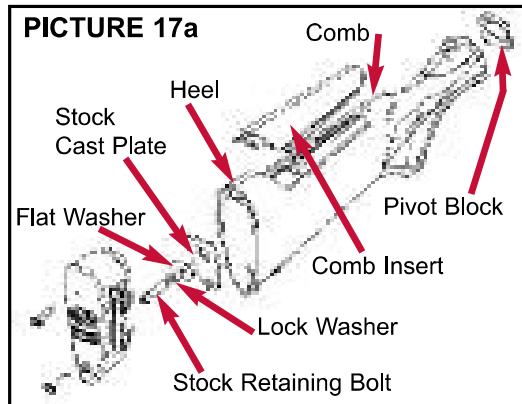
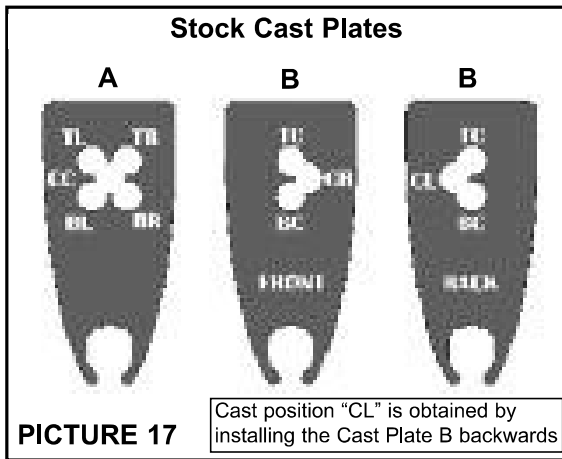

III. Heel Drop & Cast:

The Versa Max stock is designed for easy heel drop and cast adjustments for improved stock fit to enhance handling performance. By using the Stock Cast Plates provided, the heel drop can be adjusted from 2 to 2 1/2 inches and the cast can be adjusted to the right or left 1/4 inch. If the drop and/or cast is adjusted, the point-of-impact will vary slightly depending on the shooter's style.

The heel drop and cast can be adjusted by moving the stock mounting bolt to different mounting holes in the Stock Cast Plate. See Picture 17. The Versa Max is supplied with two Stock Cast Plates, providing nine (9) different drop and cast possibilities. See Chart 1.

To Adjust Heel Drop & Cast

1. Always keep the firearm pointed in a safe direction.
2. Engage the safety mechanism in the "ON" or "SAFE" position. The red band will NOT be visible.
3. Completely unload the chamber and magazine. (See "To Unload the Firearm," page 14.)
4. With the bolt locked open, visually re-check the chamber, loading port, and magazine, making sure the shotgun is completely unloaded.
5. Remove the recoil pad from the stock by removing the two mounting screws with a #2 phillips screwdriver.
6. Remove the stock retaining bolt and washers with a 3/16 Allen Wrench by turning counterclockwise.

To adjust the 5 Hole Stock Cast Plate (marked "A")

7. Choose the stock cast plate "A" mounting hole (Reference Picture 17) which corresponds to the heel drop and cast desired. See Chart 1.
8. Place the stock mounting lock washer and the washer onto the stock retaining bolt.
9. Insert the stock retaining bolt thru the desired stock cast plate "A" mounting hole (See Picture 17a) into the action spring tube.
10. Secure the stock retaining bolt with a 3/16 Allen Wrench. Torque to 75 in-lbs; do not over tighten.
11. Replace and secure the recoil pad. Do not over tighten.

To adjust the 3 Hole Stock Cast Plate (marked "B")

12. With the recoil pad and the stock retaining bolt removed, remove the stock from the receiver by pulling rearward.
13. Remove the stock cast plate from the stock by inserting a long screwdriver or punch into the front of the stock. Then push the cast plate out of the rear of the stock. See Picture 18.
14. Choose the stock cast plate "B" mounting hole (Reference Picture 17) which corresponds to the drop at heel and

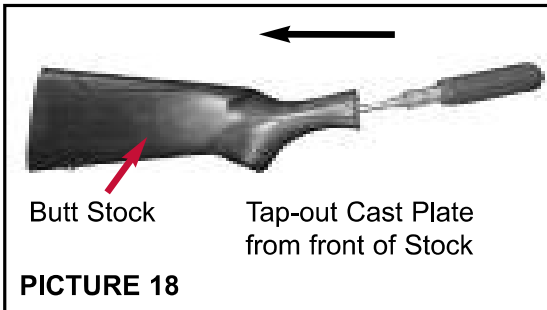

15. Place the stock mounting lock washer and washer onto the stock retaining bolt.
16. Ensure the pivot block is attached to the receiver. If not, orient the pivot block so the alignment bosses mate with the receiver.
17. Install the pivot block onto the receiver by sliding it over the action spring tube.
18. Mount the stock onto the receiver.
19. Insert the stock cast plate "B".
20. Insert the stock retaining bolt thru the desired stock cast plate mounting hole (See Picture 17a) and into the action spring tube.
21. Secure stock retaining bolt with a 3/16 Allen Wrench by turning clockwise. Torque to 75 in-lbs; do not over tighten.
22. Replace and secure the recoil pad by turning the mounting screws clockwise until tight. Do not over tighten.

Cleaning, Lubrication and Maintenance

WARNING! Before cleaning, make sure your firearm is completely unloaded (both the chamber and the magazine) and engage the safety by placing the safety mechanism in the "ON" or "SAFE" position.

Lubrication:

Over-lubrication should be avoided at all times. A light application of Rem™ Oil helps to prevent rusting.

WARNING! Excessive use of a lubricant could adversely affect the function and safe operation of your firearm. Failure to properly maintain your firearm can not only damage your firearm, it can expose you and others to unnecessary risks of personal injury or death.

When the firearm is to be stored, it should be carefully cleaned and thoroughly oiled.

Outside metal surfaces should be wiped with Rem™ Oil occasionally. When the firearm is to be reused, all excess lubrication must be removed. The chamber and bore must be thoroughly wiped dry.

For safe and dependable operation of your firearm, the barrel and action must be cleaned periodically.

Remington recommends using Remington cleaning products and lubricants or their equivalents.

WARNING! The use of a non recommended lubricant or cleaner could adversely affect the function and safe operation of your firearm. Do not use congealing lubricants. The use of non-congealing lubricants such as Rem™ Oil is strongly recommended.

NOTE: Remington's Rem™ Oil is available from your local dealer. If your dealer is out of stock, ask the dealer to order Rem™ Oil from the Remington Distributor.



WARNING! After each use, follow the lubrication and maintenance directions in this Owner's Manual. If the firearm is immersed in water, it must be thoroughly cleaned and lubricated as soon as possible. In case of saltwater immersion, first flush all parts with fresh water, then dry, clean and lubricate the firearm. If the firearm does not function properly, have it checked and repaired by a Remington

Authorized Repair Center before further use. Failure to follow these instructions may lead to firearm malfunctions which could result in serious personal injuries or death.

CAUTION: The chamber and bore should be cleaned before loading and firing the firearm the first time.

To Disassemble the Firearm for Cleaning:

CAUTION: The Versa Max firearm should **NOT** be disassembled beyond what is described in this manual, except by the factory or a Remington Authorized Repair Center.

WARNING! Unload the firearm before cleaning. Look into the ejection port and visually check the chamber and magazine to make sure there are no cartridges in the firearm. Always wear eye protection when handling, disassembling and reassembling the firearm.



To Remove the Barrel:

1. Always keep the firearm pointed in a safe direction.
2. Engage the safety mechanism in the "ON" or "SAFE" position. The red band will NOT be visible.
3. Completely unload the chamber and magazine. (See "To Unload the Firearm," page 14.)
4. With the bolt locked open, visually check the chamber, loading port, and magazine making sure the shotgun is completely unloaded.
5. Remove the magazine cap by turning it counterclockwise.
6. Remove the fore-end from the magazine by sliding it forward.
7. While holding the barrel above the barrel ring, pull the barrel from the receiver.

To Remove the Gas Pistons:

8. With the barrel removed from the receiver, remove both gas cylinder plugs by turning counterclockwise using the 3/16 Cylinder Plug Wrench provided in packaging. See Picture 19.

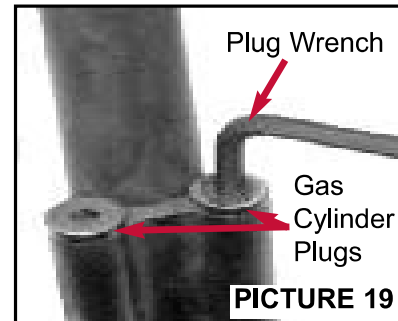

9. Remove the gas pistons from the muzzle end of the gas block. See Picture 20.

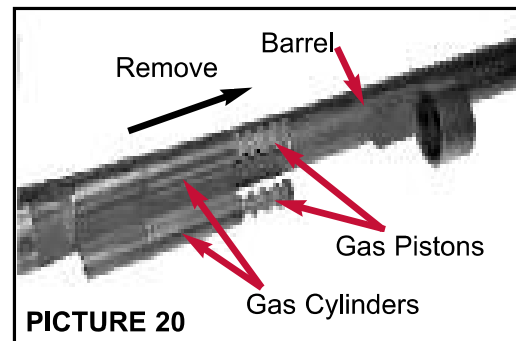

To Remove the Trigger Assembly:

10. While holding the operating handle, push the bolt release then slowly let the bolt move forward.
11. Tap out the trigger plate pin with a drive punch. See Picture 21.

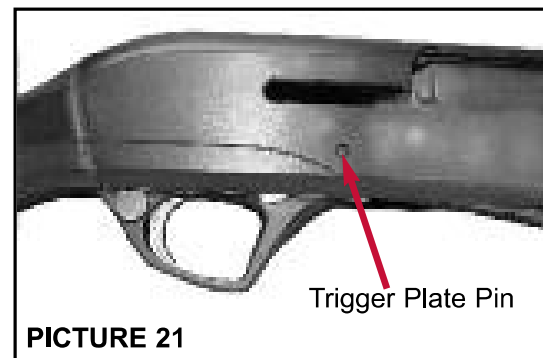

12. Remove the trigger plate from the receiver by pushing the bolt release while pulling the trigger plate downward from the receiver. See Picture 22.

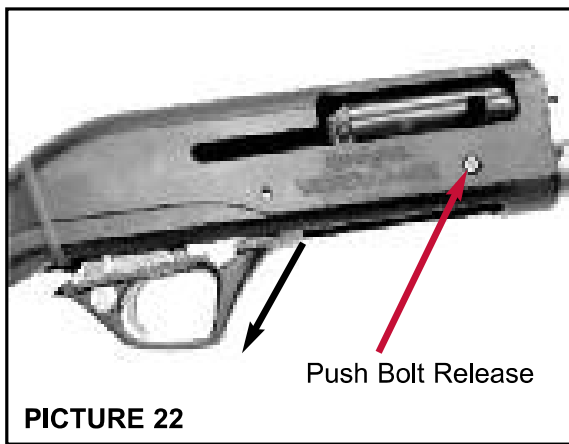

To Remove the Bolt Assembly:

13. With the bolt fully forward, the barrel and trigger plate removed, pull the operating handle outward from the bolt.
14. Remove the bolt assembly from the receiver by sliding it forward.

To Disassemble the Bolt Assembly:

WARNING! Use extreme care when removing the firing pin and firing pin retainer, as the firing pin is under compression. Wear eye protection to avoid serious personal injury.

15. While holding the firing pin in place with one hand, remove the firing pin retaining pin by pulling it outward from the bolt. See Picture 23.

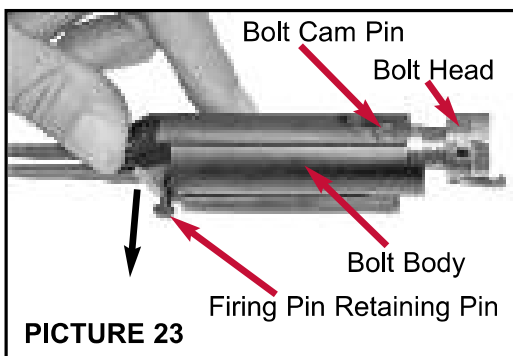

16. Remove the firing pin and firing pin spring from the rear of the bolt assembly.
17. Turn the bolt assembly upside down to remove the bolt cam pin.
18. Pull the bolt head from the bolt body.

To Clean the Barrel:

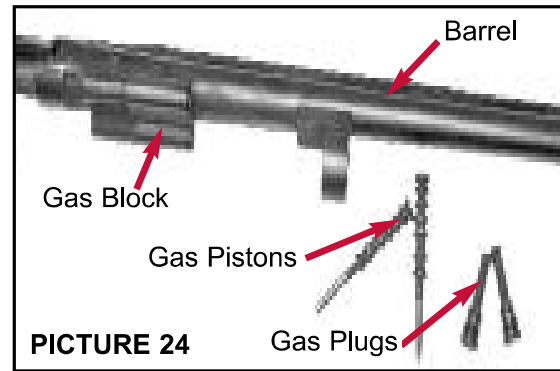

1. Use the instructions and equipment provided in a quality cleaning kit such as a Remington Cleaning Kit. For recommendations, see your dealer or a Remington Authorized Service Center.
2. Saturate cleaning patch with Brite Bore™ or equivalent.
3. Attach the patch to a cleaning rod tip.
4. Pass the patch through the bore from the chamber end to the muzzle several times, removing loose residue and fouling.
5. Select the correct gauge cleaning brush and attach a brush to the cleaning rod.
6. Spray the bore brush with Brite Bore.
7. Push the cleaning rod through the barrel several times.
8. Remove the brush from the rod and attach a tip with a cleaning patch.
9. Push the cleaning patch through the bore.
10. Repeat several times using a new cleaning patch each time until the patch is removed from the barrel without fouling residue.
11. Remove all shooting residue from the barrel's locking notch and ejector. See Picture 25.

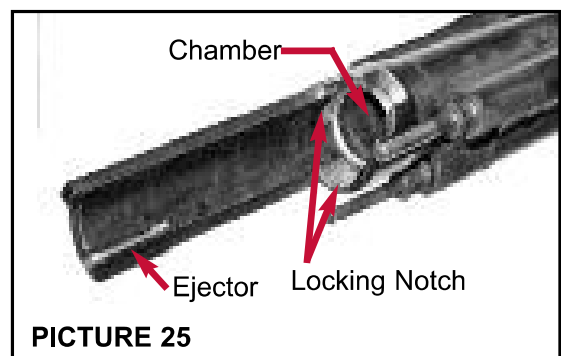

12. Spray the gas block, gas plugs, and gas pistons with Brite Bore™ or equivalent cleaner and brush to remove shooting residue.
13. To dry, use compressed air or allow to air dry.
14. Inspect the gas plug's O-rings for signs of wear. Replace if worn.
15. Push a clean patch saturated with Rem™ Oil or equivalent through the barrel including the gas block.
16. Push a clean dry patch through the barrel to remove excess lubricant.
17. Apply a light application of Rem™ Oil to the outside of the barrel, gas pistons, and O-ring with a soft clean cloth.
18. Remove all excess lubricant with a clean dry patch.

WARNING! After cleaning, Make sure the barrel and chamber are free of obstructions, see page 9, "To Check the Barrel for Obstructions."

To Clean the Choke Tube:

1. Remove the choke tube from the barrel. See "To Change the Choke Tube," page 14.
2. Brush the choke tube, including the threads with Brite Bore™ or equivalent until clean.
3. Brush the mating barrel choke tube threads with Brite Bore™ or equivalent until clean.
4. Push a clean patch through the choke tube.
5. Repeat several times using a new cleaning patch each time until all residue is removed.
6. Wipe clean and let dry.
7. When dry, apply a light application of Rem™ Oil. Include the mounting threads and mating threads in the barrel.
8. To insert the choke tube into the barrel see, "To Change the Choke Tube," page 14.

To Clean the Bolt Assembly:

1. Spray the bolt assembly components using Rem™ Action Cleaner or equivalent. Brush if necessary to remove all residue.
2. To dry, use compressed air or allow to air dry.

3. Applying a light application of Rem™ Oil.
4. Remove all excess lubricant with a clean dry patch.

To Clean the Trigger Assembly:

CAUTION: Clean the Trigger Assembly as a unit. Do not disassemble.

1. Thoroughly spray Rem™ Action Cleaner inside the trigger assembly where specified in Picture 26.

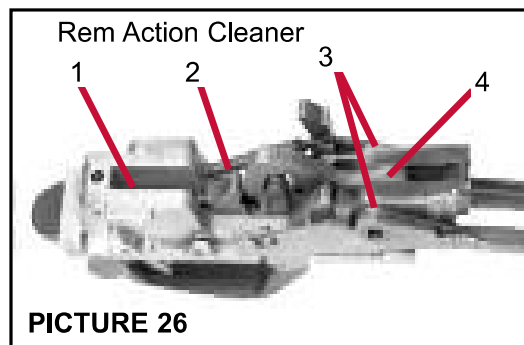

PICTURE 26

2. Thoroughly dry the trigger assembly either by compressed air or let air dry.
3. Disengage the safety mechanism by moving the safety button to the left.
4. With your thumb on hammer and the safety disengaged, pull the trigger rearward and release, see Picture 27. Repeat multiple times, ensure the trigger returns completely to the forward position each time. Repeat step 1 thru 4 if the trigger does not fully return.

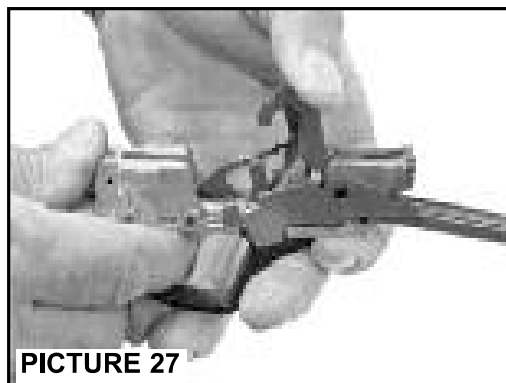

PICTURE 27

WARNING! If the trigger does not fully return to the forward position each time it is released, then your firearm is **NOT** in a safe operating condition and it must **NOT** be used until you have had it repaired by a Remington Authorized Repair Center. The use of a firearm that is not in a safe operating condition may result in serious personal injury or death.

5. With the hammer fully rearward in the cocked position; engage the safety mechanism, multiple times, in the "ON" or "Safe" position by moving the safety button fully to the shooter's right. The red band will NOT be visible.
6. The safety button must be positioned fully in the **"ON"** or **"SAFE"** position. The safety should **NOT** remain in a position between the "SAFE" and "FIRE" position. If the safety mechanism does not freely return to the full "SAFE" or "FIRE" position, repeat steps 1 and 2. **If the safety mechanism does not freely return to the "SAFE" or "FIRE" position after repeating operations 1 and 2, return the firearm to a Remington Authorized Repair Center for an inspection of the safety and trigger assembly.**

WARNING! If the safety mechanism does not freely return to the full "SAFE" or "FIRE" position; the firearm is NOT safe to use. The use of a firearm that is not in a safe operating condition may result in serious personal injury or death. Return the firearm to the factory or to a Remington Authorized Repair Center.

7. Apply a light application of Rem™ Oil to the areas specified in Picture 26.

To Clean the Receiver Assembly:

1. Thoroughly spray and brush all components inside the receiver using Rem™ Action Cleaner or equivalent.
2. Air dry or use compressed air to thoroughly dry the receiver assembly.
3. Spray the outside of the magazine tube with Rem™ Action Cleaner and wipe clean. Scrub, if necessary, with steel wool.
4. Wipe with a clean cloth and air dry or use compressed air to thoroughly dry the magazine tube.
5. Apply a light application of Rem™ Oil to the inside and outside of the receiver.
6. Remove all excess lubricant with a clean dry cloth.

NOTE: While your firearm has been designed and manufactured to provide improved corrosion protection,

only proper care will keep your firearm in a good operating condition and maintain its appearance. After extensive use, the protective coating on plated parts may be worn sufficiently, reducing the corrosion protection. Such worn parts should be replaced to assure the integrity of the corrosion protection. Remington recommends you have your firearm serviced periodically by a Remington Authorized Repair Center ensuring the proper function and replacement of any worn parts. For firearm service see: "Repair Service," on page 30.

To Reassemble the Bolt Assembly:

1. Place the bolt head in the bolt body. Align the bolt head cam pin hole with bolt body cam pin slot.
2. Insert cam pin into bolt. Align cam pin indicator with the center line of the bolt. See Picture 28.

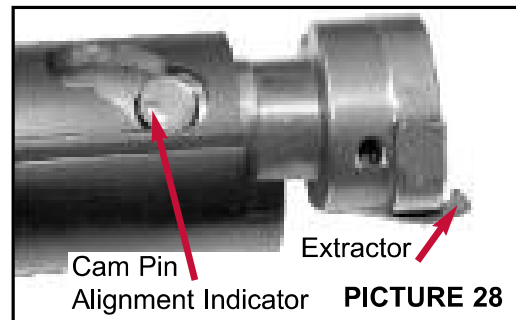

3. Place firing pin spring over the firing pin.
4. Insert the firing pin and the firing pin spring into the rear of the bolt body, through the cam pin and bolt head, until flush with rear of bolt body.
5. While holding the firing pin assembly flush with the bolt body, insert the firing pin retaining pin fully.

WARNING! When the bolt cam pin is not in the bolt assembly, the firearm is **NOT** safe to use. Leaving the bolt cam pin out of the assembly can cause serious personnel injury or death to you and others.

6. Clean and reassemble the bolt assembly, if the bolt head does not move freely. If the bolt head still does not move freely after cleaning, see page 30, to obtain service. Do Not use the firearm until it has been properly serviced.

To Reassemble the Gas Block:

1. Insert the gas pistons; small end first, into the the top of the gas cylinders. See Picture 20.
2. Secure each piston in the gas cylinder by inserting the gas cylinder plugs into the top of the gas cylinders. Secure the gas plugs into gas cylinder by turning clockwise. Do not over tighten. See Picture 19.

To Reassemble the Firearm:

WARNING! Always wear eye protection when handling, disassembling and reassembling the firearm.

1. Insert the bolt assembly; link first, into the front of the receiver.
2. Ensure the link assembly inserts into the action spring follower at the rear of the receiver. See Picture 29.

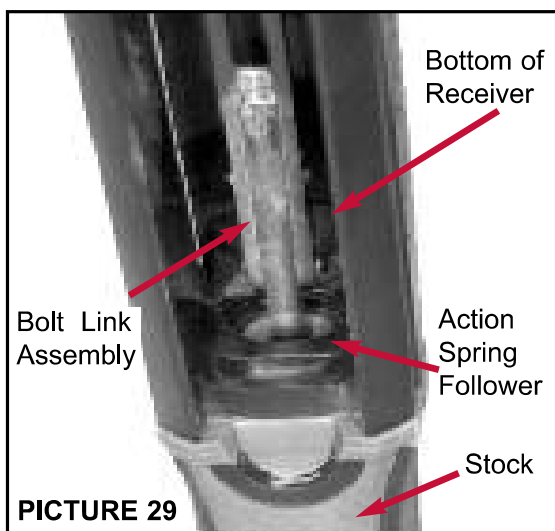

PICTURE 29

3. Insert the operating handle into the bolt body until the operating handle detent is engaged. See Picture 6.
4. To install the trigger plate, ensure the hammer is in the cocked position. If the hammer is not in the cocked position, rotate the hammer fully rearward until it engages the trigger.
5. While pushing the bolt release, insert the trigger plate assembly into the receiver. See Picture 30.
6. Attach the trigger plate to the receiver by replacing the trigger plate pin.
7. To attach the barrel to the receiver, engage the bolt hold open by pressing the cartridge release. See Picture 6.

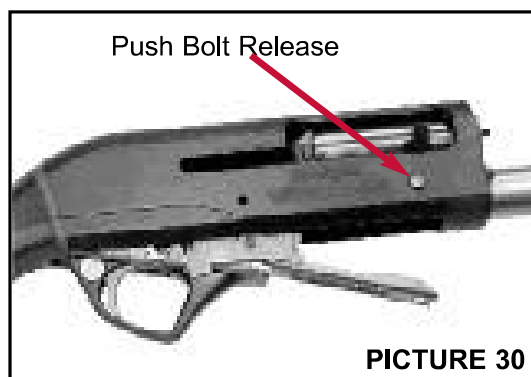

PICTURE 30

8. Open the bolt by pulling the operating handle fully rearward until the bolt locks in the open position.
9. Insert the barrel into the receiver and the barrel ring over the magazine tube. See Picture 8.
10. Place the fore-end over the magazine tube.
11. Replace the magazine cap on top of the magazine tube. Tighten by turning clockwise until hand-tight.

To Function Test the Firearm:

When the firearm is fully reassembled, a short function test should be conducted to ensure proper operation before loading or discharging the firearm. If the firearm does not function as described in any part of the Function Test, then the firearm should be reassembled and function tested again. Do **NOT** discharge the shotgun, if the firearm fails the Function Test again, send the firearm to a Remington Authorized Repair Center or call: 1-800-243-9700, Mon - Fri., 9:00AM-5:00PM Eastern Time.

WARNING! Completely unload the firearm before Function Testing. Look into the ejection port and visually check the chamber and magazine to make sure there are no cartridges in the firearm. Always wear eye protection when handling the firearm.

1. Always keep the firearm pointed in a safe direction throughout the Function Testing process.
2. Engage the safety mechanism in the "ON" or "Safe" position by moving the safety button fully to the shooter's right. The red band will NOT be visible.
3. Engage the bolt hold open by pressing the cartridge release. See Picture 6.
4. Pull the operating handle fully rearward to lock the bolt in the open position.

5. With the bolt locked open, visually check the chamber, loading port, and magazine making sure the firearm is completely unloaded. If the chamber is not unloaded, see page 14, "To Unload the Firearm."
6. Make sure the barrel and chamber are free of obstructions, see page 10, "To Check the Barrel for Obstructions."
7. With the bolt locked open, check if the bolt cam pin is installed by removing the operating handle. The bolt head should NOT move, as in Picture 31, if the cam pin is installed.

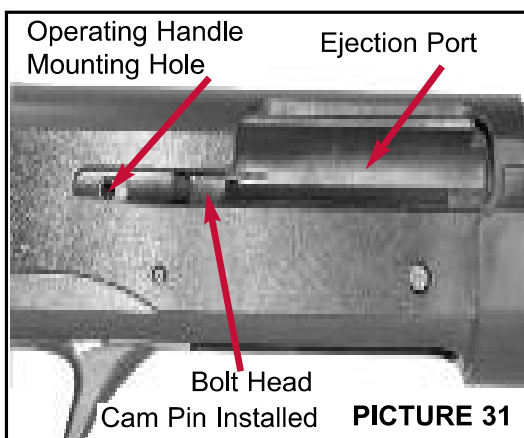

8. Tilt the muzzle downward. If the bolt head does not move forward, the bolt cam pin is installed.
9. If the bolt head moves forward, protruding into the ejection port after the operating handle is removed or when the muzzle is tilted downward, as shown in Picture 32, the bolt cam pin is Not present. Disassemble the firearm and replace the cam pin. See: "To Disassemble the Firearm for Cleaning," on page 18.

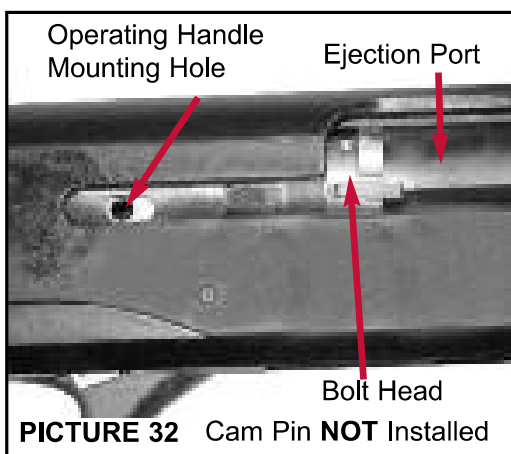

WARNING! If bolt cam pin is missing; do **NOT** use the firearm, the firearm is **NOT** safe. Using the firearm without a bolt cam pin may lead to firearm malfunctions which could result in serious personal injury or death.

10. If the bolt cam pin is present, replace the operating handle. Close the action by pressing the bolt release. The bolt should slide forward and lock into the firing position. The hammer should NOT release.

WARNING! If the hammer does **NOT** remain cocked when the action is smartly closed, the firearm is **NOT** safe to use. Using the firearm in this condition may lead to firearm malfunctions which could result in serious personal injury or death. Return the firearm to the factory or to a Remington Authorized Repair Center.

11. With the Safety mechanism engaged, pull the trigger fully rearward. The trigger should not move and the hammer should NOT release.
12. To check if the hammer released in step 10 or 11, disengage the safety mechanism by moving the safety button to the "OFF" or "FIRE" position. The red band will be visible. Pull the trigger fully rearward. The hammer should release. The cartridge release lever will move into the receiver.
13. After the trigger is pulled and released, verify the trigger returns to the fully forward position..

WARNING! If the trigger does not fully return to the forward position each time it is released, your firearm is **NOT** in a safe operating condition and it must **NOT** be used until you have it inspected and the problem corrected by a Remington Authorized Repair Center. Using the firearm in this condition may lead to firearm malfunctions which could result in serious personal injury or death.

14. Open the action by first pushing the cartridge release. Then pull the operating handle fully rearward, locking the bolt in the open position.
15. Close the action by pressing the bolt release.

16. Check the disconnecter operation by pulling the trigger fully rearward. Hold the trigger rearward. Do not release the trigger.
17. While holding the trigger rearward, pull the operating handle fully rearward to lock the bolt open.
18. While continuing to hold the trigger rearward, push the bolt release button. The hammer should not release.
19. To check if the hammer released in step 18, remove your finger from trigger. With trigger fully forward, pull the trigger fully rearward. The hammer should release and fall forward.

WARNING! If the hammer does **NOT** remain cocked while the trigger is continuously pulled, the firearm is **NOT** safe to use. Using the firearm in this condition may lead to firearm malfunctions which could result in serious personal injury or

death. Return the firearm to the factory or to a Remington Authorized Repair Center.

20. Repeat steps 11 thru 19 multiple times.
21. Engage the safety mechanism in the "ON" or "Safe" position. The red band will NOT be visible.
22. With the Safety in the "ON" or "SAFE" position, bolt locked open, and the chamber and magazine completely unloaded, verify the choke tube is present, tight, and secure. Never discharge the firearm without a choke tube installed.

WARNING! Incorrectly assembling the firearm or assembling with modified parts can result in damage to your firearm, personal injury or death to you or others. Remington recommends all service and replacement of components be performed by a Remington Authorized Repair Center. If a repair or component replacement was not completed by a Remington Authorized Repair Center we recommend that you have your firearm checked by an Authorized Repair Center. See page 30, for a Remington Authorized Repair Center nearest you.

The firearm owner and user must accept full responsibility for the correct reassembly and functioning of the firearm after disassembly or replacement of parts.

All rights to this instruction manual are reserved. The information in this document is subject to change without notice. Remington reserve the right to change the content herein without the obligation to notify any person or organization of such changes.

Remington® is a registered trademark of Remington Arms Company, LLC. and may not be used in any way without the express written consent of Remington. All other trademarks used herein remain the exclusive property of their respective owners. Nothing contained in this manual should be construed as granting, by implication or trademarks displayed herein. Misuse of any trademarks or any content of this manual is strictly prohibited. Remington shall aggressively enforce its intellectual property rights to the fullest extent of the law.

VERSA MAX™

Autoloading Shotgun

Exploded View

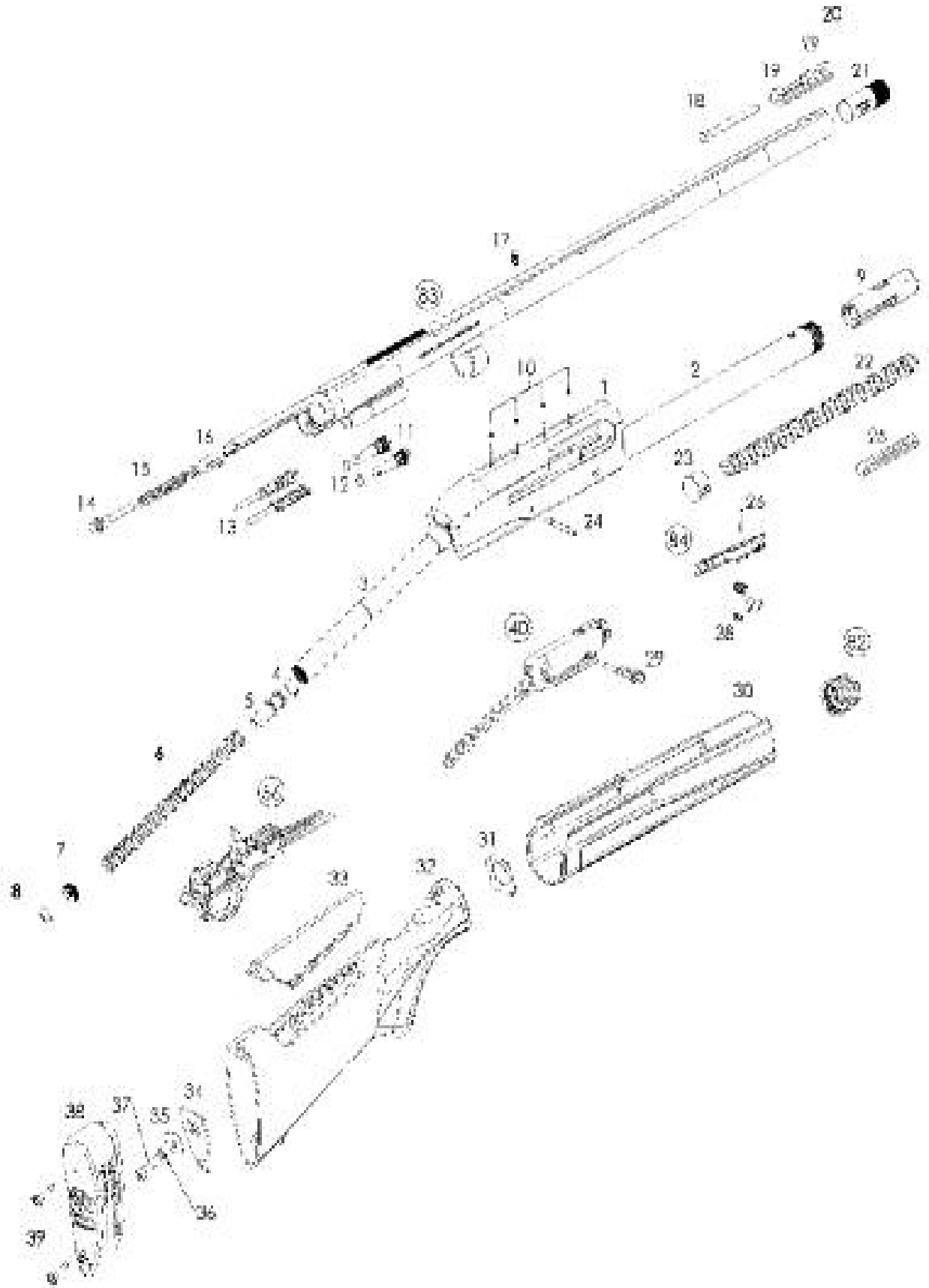

VERSA MAX™

Autoloading Shotgun

PARTS LIST

Note: Parts are subject to change without notice.

ITEM NO.	PART NAME	ITEM NO.	PART NAME
1	Receiver	27	Feed Latch Spring (A)
2	Magazine Tube	28	Feed Latch Spring (B)
3	Action Spring Tube	29	Bolt Handle
4	Action Spring Follower Retaining Ring	30	Fore-end
5	Action Spring Follower	31	Pivot Block
6	Action Spring	32	Stock Assembly
7	Action Spring Tube Plug Screw	33	Comb Insert
8	Action Spring Tube Snap Ring	33a	*Raised Comb Insert
9	Magazine Retainer	33b	*Extra High Comb Insert
10	Receiver Plug Screw (4)	34	Stock Cast Plate Primary (A)
11	Gas Cylinder Plug (2)	34a	*Stock Cast Plate Secondary (B)
12	Gas Cylinder Plug O-ring (2)	35	Stock Bolt Washer
13	Gas Piston (2)	36	Stock Bolt Lock Washer
14	Ejector Retainer	37	Stock Bolt
15	Ejector Spring	38	Recoil Pad
16	Ejector	39	Recoil Pad Mounting Screw (2)
17	Middle Sight	40	Bolt Assembly
18	Front Sight Lite Pipe	56	Trigger Plate Assembly
19	Front Sight Base	82	Magazine Cap Swivel Assembly
20	Front Sight Mounting Screw	83	Vent Rib Barrel Assembly
21	Choke Tube	84	Feed Latch Assembly
22	Magazine Spring	85	*Front Sight Accessory Kit
23	Magazine Follower	86	*Length-of-Pull Spacer Kit
24	Trigger Plate Pin	87	*Gas Cylinder Plug Wrench
25	Magazine Plug	88	*Choke Tube Wrench
26	Feed Latch Pivot Pin	89	*VersaMax Hard-case Assembly
		90	*TPA Lock

Schematic is provided for part identification only and should not be used as a guide to assemble the firearm.

* Not Shown

VERSA MAX™

Autoloading Shotgun

Bolt and Trigger Plate Assembly Exploded View

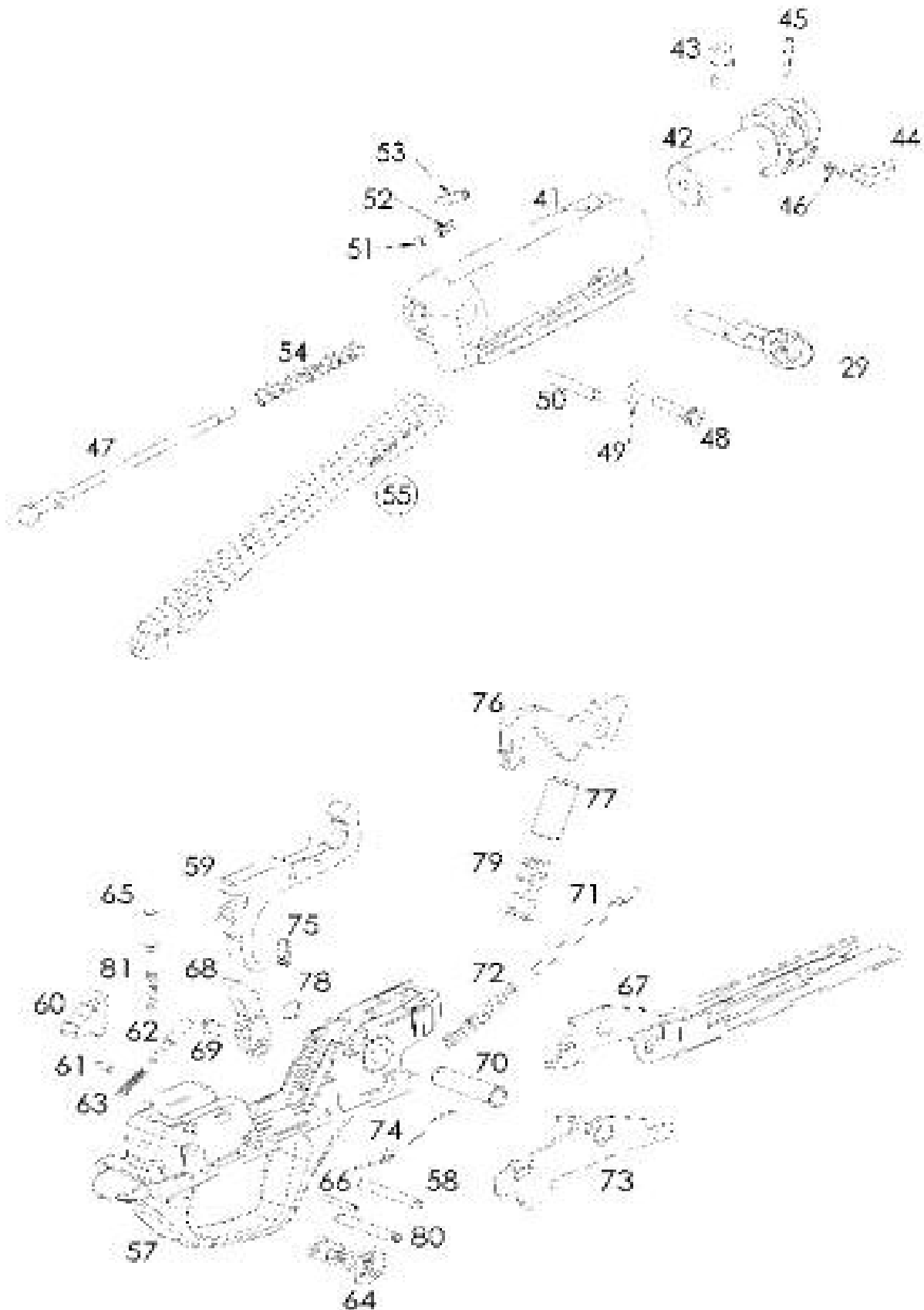

VERSA MAX™

Autoloading Shotgun

Bolt and Trigger Plate Assembly Parts List

Note: Parts are subject to change without notice.

Bolt Assembly (40)

ITEM NO.	PART NAME
41	Bolt Body
42	Bolt Head
43	Cam Pin
44	Extractor
45	Extractor Pivot Pin
46	Extractor Spring
47	Firing Pin
48	Firing Pin Retaining Pin
49	F. P. Retaining Pin O-Ring
50	Link Pivot Pin
51	Bolt Handle Detent
52	Bolt Handle Detent Spring
53	Bolt Handle Detent Retaining Pin
54	Firing Pin Spring
55	Link Assembly

Trigger Plate Assembly (56)

ITEM NO.	PART NAME
57	Trigger Plate
58	Trigger Pin
59	Trigger
60	Disconnecter
61	Disconnecter Pivot Pin
62	Disconnecter Plunger
63	Disconnecter Spring
64	Safety Button
65	Safety Detent
66	Safety Detent Retaining Pin
67	Carrier
68	Carrier Dog
69	Carrier Dog Pivot Pin
70	Carrier Pivot Tube
71	Carrier Dog Spring Strut
72	Carrier Dog Spring
73	Feed Latch Release
74	Feed Latch Release Spring
75	Trigger Return Spring
76	Hammer
77	Hammer Plunger
78	Trigger Plate Pin Detent Spring
79	Hammer Spring
80	Trigger Stop Pin
81	Safety Detent Spring

Schematic is provided for part identification only and should not be used as a guide to assemble the firearm.

How to Obtain Parts and Service From Remington Arms Company, LLC.

To Order Parts:

To order parts please visit Remington's web site @ www.remingtonpartsstore.com or call 1-800-243-9700. For additional information on service enhancements, upgrades, repair, additional barrels, and specialty parts visit www.remington.com.

To place an order or for additional information on service enhancements, up grades, and additional barrels, please call us toll free consumer service number, 1-800-243-9700, Mon.-Fri., 9:00 AM-5:00 PM Eastern time.

1. Fax completed order form (from the web site) to 1-336-548-7801.
2. To order by phone without the order form call 1-800-243-9700.

Please have the following information ready before you call.

- Firearm model and serial number.
- Part description and quantity. Part descriptions can be found on the parts listing pages 26 through 29 in this manual.
- Your complete mailing address (P.O. Box and Street Address) including zip code, telephone number and e-mail address.
- Method of payment: MasterCard, Visa, Amex or Discover card number and expiration date. A quote may be made to you over the phone. (Sorry, no C.O.D.s.)

WARNING! Use only Remington parts in Remington's firearms.

NOTE: Some parts may be restricted. See parts list for details. Owner's manuals/ instruction books may be requested via our web site at: www.remington.com or by calling 1-800-243-9700.

Repair Services:

If there is a defect with your Remington firearm that (i) you believe is, or should be, covered by the Warranty, (ii) you would like Remington to address at your cost and expense, or (iii) you would otherwise like to discuss with Remington, please contact Remington Consumer Services at 1-800-

243-9700, Mon.-Fri 9:00AM – 5:00PM. Please do not send your firearm or other item to Remington without first (a) calling this number, (b) receiving instructions from the Remington representative, and (c) obtaining a Service Request document containing your Service Repair Number. With regards to the Service Request document, Remington will either e-mail this document to you or, if you do not have an e-mail address, Remington will mail it to you. Please be sure to store your Service Request document in your records so that it is both safe and accessible. Finally, to the extent you seek Warranty coverage, please review the Warranty for your Remington firearm and note that you may void your Warranty by taking action without first contacting Remington.

WARNING! Do not send live or spent shells in your firearm or in the same box with the firearm. This is a violation of federal law. If you feel you must send spent shells, please send them in a separate package and include name, address (with zip code), telephone number, model and serial number of your firearm.

Firearm Owner's Record

Model: _____

Serial # _____

Date Purchased: _____

Purchased From: _____

Price Paid: _____

Remember to complete and return the Firearm Warranty Registration Card in order to obtain full benefit of your Limited Two Year Firearm Warranty.

A WORD ON THE MAINTENANCE AND CARE OF YOUR REMINGTON FIREARM

Don't Alter or Modify Your Firearm and Have it Serviced Regularly.

Your firearm has been designed to operate according to certain factory specifications. You'll jeopardize your safety and that of others around you by attempting to alter its trigger, mechanical safety or other mechanisms. Never alter or modify your firearm in any way.

Remington recommends that you have your firearm professionally serviced annually. You should also have your firearm professionally serviced after prolonged storage, or if there is ever any question pertaining to the proper functioning characteristics of your firearm.

Like any mechanical device, a firearm is subject to wear. It must be maintained and periodically serviced to assure optimum safety and performance. Only a qualified service facility should service, repair or modify your Remington firearm. Consult your instruction manual for location of the nearest Authorized Remington Repair Center.

Proper cleaning and lubrication are also important to firearm maintenance and are necessary to assure accuracy, safety, and reliability. Before cleaning, always make sure that your firearm is completely unloaded. And always clean the barrel from the chamber end to the muzzle when possible.

Firearm Sale or Transfer:

If your firearm has been adjusted or changed in any way and you intend to sell or otherwise transfer possession of your firearm, you must: 1) provide a complete service record, (2) warn the purchaser or recipient of your firearm that it has been adjusted or modified, and (3) give the purchaser or recipient this owner's manual for review and reference. If you do not wish to sell or transfer your firearm in an adjusted condition (recommended), return it to a Remington Authorized Repair Center for restoration of your firearm to the original factory conditions. Do Not attempt to restore the firearm to factory conditions yourself.

WARNING! NEVER alter or modify any part of the firearm. Improper alterations can make the firearm unsafe and result in personal injury or death to you or others.

This firearm should not be sold where prohibited by federal, state or local laws.