

OPERATOR'S MANUAL FOR:

Colt® King Cobra™ Revolver



COPYRIGHT® 2018 COLT MANUFACTURING COMPANY LLC ALL RIGHTS RESERVED
Information contained in this publication is free of "ITAR" restricted data



**Read the instructions, warnings, and cautions in this manual CAREFULLY
BEFORE using this revolver.**

SAFETY DEPENDS ON YOU

NOTICE

Colt shall not be responsible for injury, death, or damage to property resulting from either intentional or accidental discharge of this revolver, or from its function when used for purposes or subjected to treatment for which it was not designed. Colt will not honor claims involving this revolver which result from careless or improper handling, unauthorized adjustment or parts replacement, corrosion, neglect, the use of wrong caliber ammunition, the use of ammunition other than high quality commercially manufactured ammunition in good condition, or any combination thereof. Colt will not honor claims involving this revolver for any reason or cause when such claims are made by the second or subsequent owner.

IMPORTANT

Before it left the factory this revolver was tested, carefully inspected, and packaged. Colt cannot control product handling after it leaves the factory; therefore, please examine this revolver carefully at the time of purchase to ensure that it is unloaded and undamaged. The dealer will be pleased to assist you in making this examination and endeavor to answer your further questions.

This instruction manual should always accompany this revolver. When you lend, give, or sell this revolver, be sure this manual goes with it. If you need a replacement manual, see [page 40](#) for advice.

 **READ AND UNDERSTAND ALL THE FOLLOWING WARNINGS AND CAUTIONS BEFORE REMOVING THIS REVOLVER FROM ITS PACKAGE.**

This Colt product is classified as a Firearm by the Bureau of Alcohol, Tobacco, Firearms, and Explosives. You must follow the safety instructions for your safety and the safety of others.

SAFETY DEPENDS ON YOU



About WARNINGS and CAUTIONS

Throughout this operator's manual, you will find WARNINGS and CAUTIONS in bold print. All WARNINGS and CAUTIONS must be read carefully and followed completely. WARNINGS discuss issues that could result in damage to your revolver or serious injury or death to you or a bystander. CAUTIONS discuss issues that could result in damage or malfunction of your revolver or cause injury. Read and understand all the WARNINGS and CAUTIONS before removing the revolver from its package.



WARNING: IF THIS REVOLVER IS CARELESSLY OR IMPROPERLY HANDLED, UNINTENTIONAL DISCHARGE COULD RESULT AND COULD CAUSE INJURY, DEATH, OR DAMAGE TO PROPERTY.



WARNING: ALWAYS BE AWARE OF POSSIBLE RISK FROM DROPPING YOUR REVOLVER. SOME PARTS OF THE MECHANISM COULD BE DAMAGED, ALTHOUGH YOU MAY NOT SEE THE DAMAGE. A DAMAGED REVOLVER COULD DISCHARGE AND CAUSE INJURY, DEATH, OR DAMAGE TO PROPERTY. If your revolver has been dropped, have your revolver examined by a competent gunsmith or return it to Colt for service.



WARNING: DO NOT ALTER PARTS, AS THIS MAY RESULT IN THE PREMATURE WEARING OF PARTS OR REDUCE THE LEVEL OF SAFETY, CAUSING THE REVOLVER TO MALFUNCTION. A MALFUNCTION CAN RESULT IN AN ACCIDENTAL DISCHARGE, WHICH COULD CAUSE SERIOUS INJURY, DEATH, OR DAMAGE TO PROPERTY. If any parts do not function properly, have your revolver examined by a competent gunsmith or return it to Colt for service.



WARNING: WHEN YOU SQUEEZE THE TRIGGER, *YOU* MUST EXPECT THE REVOLVER TO FIRE, AND *YOU* MUST TAKE FULL RESPONSIBILITY FOR FIRING IT. *YOUR* CARE CAN AVOID ACCIDENTAL DISCHARGE, AND *YOU* WILL THEREBY AVOID ACCIDENTAL INJURY AND DEATH.



WARNING: THIS REVOLVER MAY DISCHARGE ACCIDENTALLY WHEN A ROUND IS IN THE CHAMBER IF IT IS DROPPED OR RECEIVES A BLOW TO THE MUZZLE OR FRONT OF THE REVOLVER. This can occur regardless of the position of the hammer or any of the various safety devices. Therefore, extra care and strict adherence to these instructions by the revolver user is mandatory for minimizing the risk of accidents.



WARNING: ALWAYS HANDLE YOUR REVOLVER AS IF IT WERE LOADED so that you never fire it accidentally when you think it is unloaded.





WARNING: NEVER POINT YOUR REVOLVER AT ANYTHING YOU DO NOT INTEND TO SHOOT to prevent injury or death in the event of an accidental discharge.

SAFETY DEPENDS ON YOU

 **WARNING:** NEVER LEAVE A LOADED REVOLVER UNATTENDED. Someone, especially a child, may fire it and cause injury, death, or damage to property.

 **WARNING:** NEVER LEAVE A REVOLVER COCKED READY TO FIRE, as this condition is extremely dangerous, and the revolver could easily be accidentally discharged causing injury, death, or damage to property.

 **WARNING:** NEVER TAKE ANYONE'S WORD THAT A REVOLVER IS UNLOADED; check for yourself with your finger off the trigger and the revolver pointed in a safe direction so that you never fire the revolver accidentally when you think it is unloaded.

 **WARNING:** ALWAYS BE SURE YOUR BACKSTOP IS ADEQUATE to stop and contain bullets before firing so that you do not hit anything outside your shooting area. A bullet can travel through or past your target up to three miles... if in doubt, don't shoot.

 **WARNING:** NEVER DRINK ALCOHOLIC BEVERAGES OR TAKE DRUGS BEFORE OR DURING SHOOTING as your judgment, vision, and motor skills could be seriously impaired, making your revolver handling unsafe.

 **WARNING:** NEVER SHOOT AT A HARD SURFACE, SUCH AS ROCK, OR A LIQUID SURFACE, SUCH AS WATER. A bullet may ricochet and travel in any direction to strike you or an object you cannot see causing injury, death, or damage to property.

 **WARNING:** NEVER DISCHARGE A REVOLVER NEAR FLAMMABLE MATERIAL. Flame and sparks erupt from the revolver when it is discharged, which could ignite flammable materials or cause gasses to explode.

 **WARNING:** ALWAYS WEAR AND ENCOURAGE OTHERS TO WEAR EYE AND EAR PROTECTION.

TABLE OF CONTENTS

<u>TITLE</u>	<u>PAGE NO.</u>
Cover	1
Notice	2
About Warnings and Cautions	3-4
Table of Contents	5
Illustration of Revolver	6
Description:	7-14
Characteristics of Revolver	7-10
Operating Features	11-14
Maintenance:	15-18
Maintenance	15
Cleaning Materials	16
Cleaning & Lubrication	16-18
Operation:	19-34
Sights	19-20
Loading	21-24
Aiming and Firing	25-30
Unloading	31-32
Dangerous Situations	33-34
Misfires	33
Bore Obstructions	34
Health and Environmental	35
Storage	35
Revolver Record	36
Service Agreement	37
Servicing and Repair	38

SAFETY DEPENDS ON YOU

ILLUSTRATION OF REVOLVER

COLT KING COBRA REVOLVER



SAFETY DEPENDS ON YOU

DESCRIPTION

This operator's manual describes the Colt King Cobra Revolver and includes information on its features.

The Colt King Cobra is a single/double action stainless steel compact revolver. Incorporates a full length, snag free, ejector shroud and interchangeable front sight on the barrel. The revolver offers excellent accuracy, balance, and controllability. This revolver utilizes an improved action which features a transfer bar which prevents the hammer from striking the firing pin until the trigger is squeezed and held back.

 **CAUTION:** Only you can control the configuration of your revolver. Make sure it always complies with federal, state, and local firearms laws and regulations that apply to you. Check that any accessories you may attach, are legal in your state and the state you intend to use it. If you are unsure, ask a local, licensed firearms dealer.

CHARACTERISTICS OF REVOLVER

TYPE OF REVOLVER:

Colt King Cobra, six shot, single/double action revolver, caliber .357 magnum.
Stainless Steel, smooth trigger, shrouded ejector rod, and ramp front sight.

AMMUNITION:

.357 Magnum
38 Special & 38 Special +P, can be fired safely from this revolver

The cartridge designation is located on the barrel of the revolver (Figure 1). This indicates the correct ammunition that must be used in the revolver.

 **WARNING:** NEVER USE AMMUNITION NOT SPECIFICALLY DESIGNATED FOR USE IN YOUR REVOLVER. FAILURE TO USE THE CORRECT TYPE OR CALIBER OF AMMUNITION MAY CAUSE THE REVOLVER JAM, OR TO FAIL TO FIRE, OR GENERATE EXCESSIVE PRESSURE, WHICH CAN DAMAGE OR EVEN RUPTURE THE REVOLVER, CAUSING PERSONAL INJURY, DEATH, OR PROPERTY DAMAGE. To protect you from danger and your revolver from damage, Colt does not recommend the use of reloads or remanufactured ammunition.

CHARACTERISTICS OF REVOLVER (Cont.)



CARTRIDGE DESIGNATION

Figure 1

CHARACTERISTICS OF REVOLVER (Cont.)

AMMUNITION SELECTION:

Your Colt King Cobra Revolver is designed to function with a variety of brands and types of factory manufactured ammunition in the appropriate caliber, but not all ammunition will provide the same results. It is recommended that you go to the range and fire different ammunition, once you find the ammunition that functions best, keep using it. Do not use ammunition that has any indications of damage to the cartridge or bullet.

It is recommended that you use commercially manufactured ammunition that is manufactured in accordance with the specifications of the Sporting Arms and Ammunition Manufacturers' Institute (SAAMI).

 **WARNING:** ALWAYS INSPECT THE AMMUNITION BEFORE USING IT. NEVER USE DIRTY, CORRODED, OR DAMAGED AMMUNITION. USING IT CAN DAMAGE OR EVEN RUPTURE THE REVOLVER, CAUSING PERSONAL INJURY, DEATH, OR PROPERTY DAMAGE.

 **WARNING:** IF AMMUNITION NOT SPECIFIED FOR USE IN YOUR REVOLVER FITS INTO THE CHAMBER FIRING THAT AMMUNITION CAN DAMAGE OR EVEN RUPTURE THE REVOLVER, CAUSING PERSONAL INJURY, DEATH, OR PROPERTY DAMAGE. NEVER LOAD OR FIRE AMMUNITION NOT SPECIFIED FOR YOUR REVOLVER.

REVOLVER SPECIFICATIONS:

Overall Length:	8.00 inches	(20.32 cm)	
Barrel Length:	3.0 inches	(5.34 cm)	(rifling 1 in 14 LH twist)
Weight (unloaded):	1.75 lbs.	(.794 kg)	

CHARACTERISTICS OF REVOLVER (Cont.)

FUNCTION:

Most revolver models can be fired by Single Action Mode, cocking the hammer manually and then squeezing the trigger to fire, or by Double Action Mode, squeezing the trigger to rotate the cylinder, cock the hammer and then fire the revolver.

Some revolver models are DAO (Double Action Only) and have the hammer spur removed. They can only be fired by squeezing the trigger fully. There is no sear to hold the hammer back in single action mode.

In either mode the functioning sequence is similar, when the trigger or hammer rotates rearward, the trigger unlocks the bolt from the cylinder, while the trigger lifts the hand to rotate the cylinder clockwise, the trigger also moves the transfer bar up behind the firing pin. When the hammer is approximately halfway to its cocked position the bolt is released from the trigger and rides on the outside of the cylinder. The cylinder continues to rotate until the bolt drops into the next cylinder notch assuring proper alignment of the chamber, barrel, and firing pin before the hammer is released. Once the hammer is released from the trigger, it rotates forward striking the transfer bar transferring energy to the firing pin to ignite the cartridge in the chamber. Once the trigger is released, the trigger will rotate back to its at rest position pulling the transfer bar down from behind the firing pin, leaving a gap between the firing pin and hammer. Without the trigger holding the transfer bar up behind the firing pin there is no way for the hammer to contact the transfer bar or firing pin.

Single Action Mode: When the hammer is manually cocked, it will remain cocked until the trigger is squeezed to fire the revolver.



WARNING: DO NOT ATTEMPT TO HOLSTER, CARRY, OR STORE YOUR REVOLVER WITH THE HAMMER COCKED. REMEMBER TO KEEP THE REVOLVER POINTED IN A SAFE DIRECTION AND YOUR FINGER OFF THE TRIGGER. THE REVOLVER WILL FIRE IF THE TRIGGER IS PULLED.

Double Action Mode & DAO (Double Action Only): Pulling the trigger rearward, rotates both the cylinder and hammer until the trigger releases the hammer allowing it to rotate forward striking the transfer bar, transferring energy to the firing pin to fire the revolver.

OPERATING FEATURES

The operating features section identifies components of the Colt King Cobra Revolvers and provides a description of their function:

Trigger (Figures 3 & 4):

When pulled fires the revolver. Interacts with the hammer, hammer strut, bolt, hand, and transfer bar.

Sights:

Used to align revolver with target. The rear sight is a fixed notch in the top strap of the frame (Figure 2). The front sight (Figure 3) is used in conjunction with the rear sight notch to provide alignment to target.

Hammer (Figures 1, 2, 3 & 4)

When released from a cocked position, in either double action or single action mode, rotates to hit the transfer bar. Transferring energy to the pin firing pin to ignite the cartridge.



WARNING: DO NOT ATTEMPT TO CLOSE OR FORCIBLY SLAM THE CYLINDER INTO THE FRAME WITH THE HAMMER COCKED, AS YOU COULD DAMAGE THE MECHANISM.



WARNING: DO NOT ATTEMPT TO FORCE THE CYLINDER OPEN WITH THE HAMMER COCKED DOING SO COULD DAMAGE THE REVOLVER MECHANISM.

Transfer Bar (Figure 2):

Is a safety mechanism. When it is being held up behind the firing pin and the hammer is released, the hammer hits the transfer bar transferring energy to the firing pin to ignite the cartridge in the chamber. Without the trigger being held in the firing position, the transfer bar is not held up behind the firing pin. This creates a space between the hammer and firing pin, preventing the hammer from striking the firing pin until the trigger is squeezed and held back. The revolver will not fire provided the trigger is not in the firing position.

Hand:

Rotates the cylinder to align the chamber with the barrel and firing pin. However, it serves also as a safety device preventing the cylinder from being opened or closed while the hammer is in the cocked position.

Barrel (Figure 3):

Contains rifling which imparts a stabilizing spin to the bullet so that it will follow a more accurate path to the target.

Cylinder (Figures 3 & 4):

Contains six chambers for loading of up to six cartridges.



WARNING: FORCING DAMAGED AMMUNITION INTO THE CYLINDER CHAMBERS COULD DAMAGE YOUR REVOLVER AND COULD RESULT IN INJURY, DEATH, OR DAMAGE TO PROPERTY

OPERATING FEATURES (Cont.)

Ejector Rod & Ratchet (Figure 4):

Provides a means to eject cartridges (fired or unfired) from the cylinder.

Cylinder Latch (Figure 4):

Locks the cylinder into the frame. When pulled rearward it allows the cylinder to be opened to the left side of the revolver.



Figure 2

OPERATING FEATURES (Cont.)



Figure 3

OPERATING FEATURES (Cont.)



Figure 4

SAFETY DEPENDS ON YOU

MAINTENANCE

Maintenance instructions tell the operator how to clean, lubricate, assemble, and do a functional check on the revolver. Like any other precision mechanism, your revolver will perform better, last longer, and remain safer when it is properly maintained. Follow the instructions in this section to keep your revolver in good condition.

Tools Required: Cleaning kit for revolvers
Materials Required: Dry, lint free cloth
 Break-Free® CLP or good quality gun oil

Note: If the revolver has been used in salt air, water, mud, or sand, it should be completely disassembled, cleaned, and inspected by a competent gunsmith or returned to Colt for service.

 **WARNING:** ALWAYS ENSURE THAT THE REVOLVER IS UNLOADED BEFORE CLEANING, LUBRICATING, AND/OR ASSEMBLING. MAKE SURE TO INSPECT ALL CHAMBERS AND MAKE SURE ALL ARE EMPTY. ALWAYS KEEP THE MUZZLE POINTED IN A SAFE DIRECTION. IF THIS REVOLVER IS CARELESSLY OR IMPROPERLY HANDLED, AN ACCIDENTAL DISCHARGE COULD RESULT AND COULD CAUSE SERIOUS INJURY, DEATH, OR DAMAGE TO PROPERTY.

 **WARNING:** WEAR SAFETY GLASSES IN CASE YOU LOSE CONTROL OF SOME OF THE SPRING LOADED COMPONENTS WHICH COULD CAUSE INJURY.

IMPORTANT: DO NOT FIELD STRIP YOUR REVOLVER ANY FURTHER THAN DESCRIBED IN THIS MANUAL. IF YOU DO SO YOU WILL VOID YOUR SERVICE AGREEMENT. IF ADDITIONAL MAINTENANCE IS REQUIRED, MAKE SURE THAT THE REVOLVER IS NOT LOADED AND RETURN IT TO COLT FOR SERVICE. FOR SPARE PARTS, SEEK ADVICE FROM THE DEALER, WHO SHOULD HAVE INFORMATION ON HOW TO OBTAIN GENUINE COLT PARTS, OR CONTACT COLT CUSTOMER SERVICE.

CLEANING MATERIALS

Cleaning should be performed according to instructions in this manual using Break-Free® CLP or good quality gun oil.

Use a cleaning kit or cleaning equipment designed to clean revolvers. The cleaning kit should contain: a good quality gun oil, cleaning rods, bore patches, a small brush, a bore brush, and a chamber brush at a minimum.

 **CAUTION:** If your firearm has been coated with a decorative finish, it is susceptible to damage from certain chemicals and abrasive surfaces. Do not use solvents, paint thinners, or gun cleaning products to clean the decorative finish. Do not store the firearm with lubricants or oils on the decorative finishes as they will weaken the outer protective coating of the decorative finish.

 **CAUTION:** If your firearm has been coated with a decorative finish, the best way to care for and maintain the longevity of the decorative finish is to use a clean and soft cloth dampened with water and gently wiping the decorative finish. As always, you may use normal gun oil lubricants to clean and maintain the internal components of the firearm using care not to get the products on the decorative finish.

CLEANING & LUBRICATION

 **WARNING:** ALWAYS UNLOAD YOUR REVOLVER IMMEDIATELY AFTER USE AND PRIOR TO CLEANING AND STORING TO MINIMIZE THE RISK OF ACCIDENTAL DISCHARGE. IF THIS REVOLVER IS CARELESSLY OR IMPROPERLY HANDLED, AN ACCIDENTAL DISCHARGE COULD RESULT AND COULD CAUSE SERIOUS INJURY, DEATH, OR DAMAGE TO PROPERTY.

WHEN TO CLEAN:

After Firing: Clean your revolver as soon as possible. This will lessen the opportunity for corrosion to start.

Periodically: It is suggested that you clean your revolver when necessary and at least once or twice a year in a temperate climate, or as often as once a week in a tropical climate. If you get your revolver wet, clean it as soon as possible.

CLEANING & LUBRICATION (Cont.)



WARNING: DO NOT ATTEMPT TO FORCE THE CYLINDER OPEN WITH THE HAMMER COCKED DOING SO COULD DAMAGE THE REVOLVER MECHANISM.

1. Keep your finger off the trigger and outside of the trigger guard.
2. Ensure that the hammer is not cocked.
3. Open revolver by pulling cylinder latch to the rear and pushing the cylinder out to the left of the revolver.
4. Push ejector rod rearward forcing out all live rounds or empty cartridge cases from the chambers. When they are clear of the chambers, remove from revolver.

NOTE: The ejector rod spring should return the ejector rod to its seated position under its own force.

5. Clean bore of barrel. Depending on the level of usage before cleaning a bore brush or cleaning patch may be used to clean the bore.
6. Clean each of the six chambers in the cylinder. Depending on the level of usage before cleaning a chamber brush or cleaning patch may be used to clean each chamber.
7. Use a small brush with a little cleaning solution to clean the front face of the cylinder, rear face of the barrel, and the revolver frame.
8. Using a small brush or cleaning cloth with a little cleaning solution clean the rear face of the cylinder and ratchet. Then push the ejector rod rearward and clean behind the ratchet.
9. Wipe all cleaning solution from the revolver.
10. Lightly oil a bore patch and pass it through the barrel leaving a thin film of oil on the bore.
11. Lightly oil a bore patch and pass it through each chamber of the cylinder leaving a thin film of oil in each chamber.

CLEANING & LUBRICATION (Cont.)

NOTE: Before use, pass a dry bore patch through the barrel and each chamber to remove as much oil as possible before firing the revolver.

12. Close the cylinder by pushing the cylinder into the frame until the cylinder latch moves forward into its closed position.

NOTE: If necessary, cock the hammer and a few drops of oil may be applied to the internal components.

13. Then wipe all external surfaces with a cloth lightly moistened with gun oil.

IMPORTANT: DO NOT FIELD STRIP YOUR REVOLVER. IF YOU DO SO YOU WILL VOID YOUR SERVICE AGREEMENT. IF ADDITIONAL MAINTENANCE IS REQUIRED, MAKE SURE THAT THE REVOLVER IS NOT LOADED AND HAVE IT EXAMINED BY A COMPETENT GUNSMITH OR RETURN IT TO COLT FOR SERVICE. FOR SPARE PARTS, SEEK ADVICE FROM THE DEALER, WHO SHOULD HAVE INFORMATION ON HOW TO OBTAIN GENUINE COLT PARTS, OR CONTACT COLT CUSTOMER SERVICE.

**OPERATION
SIGHTS****FRONT SIGHT**

1. The front sight is interchangeable, standard model comes with a fiber optic. Optional sights configurations are available in either a Tritium night sight or a brass bead configuration.
2. To change the front sight, insert a .050" allen wrench into the hole just above the muzzle of the barrel. Turn counter-clockwise to loosen the #4-40 set screw and pull up on the front sight to remove it. Insert a new front sight and tighten the #4-40 set screw. It is recommend to use a medium thread locker on the set screw to prevent it from loosening during shooting (Figure 5).

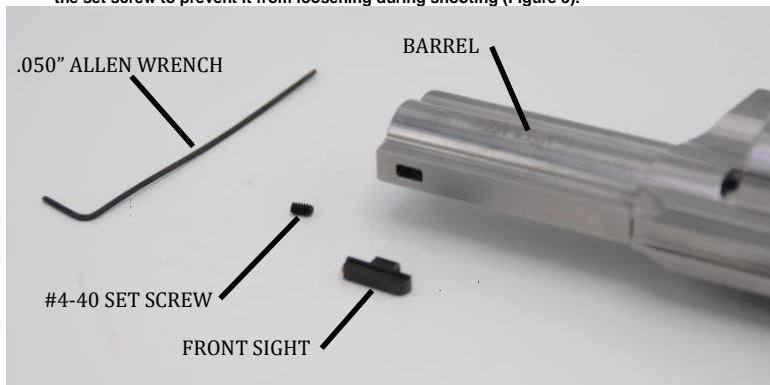

Figure 5

DETAILS OF THE SIGHTS FURNISHED WITH YOUR REVOLVER MAY BE DIFFERENT DEPENDING ON YOUR MODEL

SIGHTS (Cont.)

REAR SIGHT

1. Rear Sight is a fixed notch cut into the upper strap of the frame (Figure 6).



Figure 6

NOTE: While many sights operate in a similar manner to the methodology previously described, if your Colt revolver is outfitted with optics or accessories other than those depicted in this section, it is suggested that you see the manufacturer's instructions for those optics or accessories.

SAFETY DEPENDS ON YOU

LOADING

⚠ WARNING: DO NOT ATTEMPT TO FORCE THE CYLINDER OPEN WITH THE HAMMER COCKED DOING SO COULD DAMAGE THE REVOLVER MECHANISM.

⚠ CAUTION: TO MINIMIZE THE RISK OF UNINTENTIONAL DISCHARGE, LOAD LIVE AMMUNITION INTO REVOLVER ONLY WHEN YOU INTEND TO USE IT.

⚠ WARNING: ALWAYS KEEP MUZZLE POINTING IN A SAFE DIRECTION WHEN LOADING. IF THIS REVOLVER IS CARELESSLY OR IMPROPERLY HANDLED, AN ACCIDENTAL DISCHARGE COULD RESULT AND COULD CAUSE SERIOUS INJURY, DEATH, OR DAMAGE TO PROPERTY.

1. Keep your finger off the trigger and outside of the trigger guard (Figure 7).



Figure 7

SAFETY DEPENDS ON YOU

LOADING (Cont.)

2. Ensure that the hammer is not cocked.
3. Open the cylinder by pulling the cylinder latch to the rear and push the cylinder out to the left side of the revolver (Figure 8).
4. With the cylinder open, check all six chambers to ensure that they are clean and unobstructed (Figure 8).



Figure 8

LOADING (Cont.)

5. Insert a round of ammunition into each chamber, making sure to fully seat each cartridge (Figure 9).



Figure 9

LOADING (Cont.)

6. Push the cylinder into the frame until the cylinder latch moves forward into its closed position. Rotate the cylinder if necessary to ensure that the bolt is engaged with the cylinder preventing free rotation of the cylinder (Figure 10).

NOTE: Depending on the position of the cylinder when first pushed into the frame, it is sometimes possible that the bolt will not engage the cylinder to lock it. Check for proper bolt engagement by attempting to rotate the cylinder clockwise by hand. If the bolt is engaged properly the cylinder will not rotate. If the cylinder rotates, rotate it until the bolt engages the cylinder and prevents further rotation.

7. The revolver is now loaded.

! WARNING: DO NOT ATTEMPT TO CLOSE THE CYLINDER WITH THE HAMMER COCKED. DO NOT SWING OR SLAM THE CYLINDER FORCIBLY INTO PLACE WITH THE HAMMER COCKED. DOING ANY OF THESE ACTIONS COULD DAMAGE THE REVOLVER MECHANISM.

! WARNING: THE REVOLVER IS NOW LOADED. ALWAYS KEEP MUZZLE POINTING IN A SAFE DIRECTION. IF THE REVOLVER IS *NOT* TO BE FIRED, UNLOAD IT AS EXPLAINED ON **PAGES 31-32**. IF THIS REVOLVER IS CARELESSLY OR IMPROPERLY HANDLED, UNINTENTIONAL DISCHARGE COULD RESULT AND COULD CAUSE INJURY, DEATH, OR DAMAGE TO PROPERTY.



Figure 10

AIMING AND FIRING

⚠ WARNING: KEEP REVOLVER POINTING IN A SAFE DIRECTION. DO NOT TOUCH TRIGGER AND KEEP FINGERS AWAY THE FRONT OF THE CYLINDER. IF THIS REVOLVER IS CARELESSLY OR IMPROPERLY HANDLED, AN ACCIDENTAL DISCHARGE COULD RESULT AND COULD CAUSE SERIOUS INJURY, DEATH, OR DAMAGE TO PROPERTY.

⚠ WARNING: ALWAYS WEAR EYE AND EAR PROTECTION EVERY TIME YOU DISCHARGE YOUR REVOLVER.

⚠ WARNING: ALWAYS KEEP YOUR FINGERS AND OTHER BODY PARTS AWAY FROM THE GAP BETWEEN THE CYLINDER AND BARREL OF THE REVOLVER. FAILURE TO DO SO RISKS INJURY FROM HOT GASES AND/OR DEBRIS WHEN FIRING A CARTRIDGE (Figure 11).



Figure 11

1. With the loaded revolver pointed in a safe direction, keep your fingers outside the trigger guard.
2. Grip the revolver using a two-hand hold. Keeping hands and fingers away from the barrel/cylinder gap. Never extend your fingers beyond the front of the cylinder when firing a revolver (Figure 11).
3. Take aim by aligning the target with the front and rear sights.

AIMING AND FIRING (Cont.)

4. There are two ways to fire your revolver:
 - a. Double Action Mode and DAO (Models) - After aligning the target and sights, squeeze the trigger fully rearward until it cocks and releases the hammer to fire the revolver. To fire the second and subsequent rounds, release the trigger fully and squeeze it again to cock and release the hammer. Repeat until you have completed firing, then remove finger from inside the trigger guard (Figure 12).

IMPORTANT: Trigger must be fully returned forward before squeezing it again. Failure to do so can prevent the action from fully cycling and will prevent you from being able to fire the next shot.



Figure 12

⚠ WARNING: NEVER TRY TO COCK THE HAMMER ON THE DAO MODEL, THE HAMMER WITHOUT THE SPUR COULD SLIP OUT OF YOUR GRASP AND CAUSE THE REVOLVER TO DISCHARGE IF THE TRIGGER IS PULLED.

AIMING AND FIRING (Cont.)

- b. Single Action Mode- After aligning the target and sights, with finger outside the trigger guard, draw the hammer fully back to the cocked position (Figure 13) where it will be held by the sear. Remove thumb or finger from hammer spur and place finger inside trigger guard and gently squeeze trigger until the hammer falls. Repeat procedure until you have completed firing.

IMPORTANT: Trigger travel and pressure is significantly less in single action mode to fire the revolver. So it is your responsibility to exercise care in handling the revolver when firing in single action mode.



Figure 13

AIMING AND FIRING (Cont.)

IMPORTANT: If you decide to not fire the revolver from the cocked single action position, then lower the hammer as follows:

- c. With your fingers off the trigger and outside the trigger guard, place the thumb of your free hand between the hammer and frame of the revolver to prevent the hammer from moving fully forward (Figure 14).



Figure 14

SAFETY DEPENDS ON YOU

AIMING AND FIRING (Cont.)

- d. Place the thumb of your firing hand firmly on the hammer spur. You must control the hammer with your thumb, if you lose control of the hammer and it slips while the trigger is being held back the revolver will fire (Figure 15).



Figure 15

AIMING AND FIRING (Cont.)

- e. While controlling the hammer gently squeeze the trigger to allow the hammer to move forward out of its cocked position.
- f. Release the trigger completely and remove your finger from the trigger guard before lowering the hammer to its uncocked (at rest) position (Figure 16).

! **WARNING:** FAILURE TO REMOVE YOUR FINGER FROM THE TRIGGER GUARD AS SOON AS THE HAMMER IS OUT OF ITS COCKED POSITION COULD CAUSE THE REVOLVER TO FIRE IF YOUR THUMB SLIPS OFF THE HAMMER SPUR.

5. Keep revolver pointed in a safe direction and unload revolver as described in the unloading section of this manual.

! **WARNING:** NEVER LEAVE REVOLVER COCKED READY AND TO FIRE. ONLY PLACE THE REVOLVER IN SINGLE ACTION MODE WHEN YOU ARE READY TO FIRE THE REVOLVER.

! **WARNING:** IF YOUR REVOLVER FAILS TO FIRE, KEEP IT POINTED IN A SAFE DIRECTION, AND REFER TO THE MISFIRE SECTION ON **PAGE 33**. IF THIS REVOLVER IS CARELESSLY OR IMPROPERLY HANDLED, AN ACCIDENTAL DISCHARGE COULD RESULT AND COULD CAUSE SERIOUS INJURY, DEATH, OR DAMAGE TO PROPERTY.



Figure 16

UNLOADING

 **WARNING:** ALWAYS KEEP MUZZLE POINTING IN A SAFE DIRECTION. IF THIS REVOLVER IS CARELESSLY OR IMPROPERLY HANDLED, AN ACCIDENTAL DISCHARGE COULD RESULT AND COULD CAUSE SERIOUS INJURY, DEATH, OR DAMAGE TO PROPERTY.

 **WARNING:** ALWAYS UNLOAD YOUR REVOLVER IMMEDIATELY AFTER USE AND PRIOR TO CLEANING AND STORING TO MINIMIZE THE RISK OF ACCIDENTAL DISCHARGE. IF THIS REVOLVER IS CARELESSLY OR IMPROPERLY HANDLED, AN ACCIDENTAL DISCHARGE COULD RESULT AND COULD CAUSE SERIOUS INJURY, DEATH, OR DAMAGE TO PROPERTY.

 **WARNING:** DO NOT ATTEMPT TO FORCE THE CYLINDER OPEN WITH THE HAMMER COCKED. DOING SO COULD DAMAGE THE REVOLVER MECHANISM.

1. Keep your finger off the trigger and outside of the trigger guard.
2. Ensure that the hammer is not cocked.
3. Open the cylinder by pulling the cylinder latch to the rear and push the cylinder out to the left side of the revolver.
4. With the cylinder open, push the ejector rod rearwards forcing out all of the loaded cartridges (Figure 17). With the cartridges clear of the chambers remove them from the revolver. Allow ejector rod to return to its seated position in the cylinder.

NOTE: The ejector rod spring should return the ejector rod/ratchet to its seated position under its own force.

5. With the hammer still in the uncocked position, push the cylinder into the frame until the cylinder latch moves forward into its closed position.
6. After pushing cylinder into frame, the cylinder should be rotated until the bolt engages the cylinder.
7. Collect live ammunition for safe storage and properly dispose of any spent cartridge cases.

 **WARNING:** DO NOT ATTEMPT TO CLOSE THE CYLINDER WITH THE HAMMER COCKED. DO NOT SWING OR SLAM THE CYLINDER FORCIBLY INTO PLACE WITH THE HAMMER COCKED. DOING ANY OF THESE ACTIONS COULD DAMAGE THE REVOLVER MECHANISM.

 **WARNING:** REVOLVER IS CLEAR ONLY WHEN ALL CHAMBERS ARE EMPTY AND THE HAMMER IS IN THE UNCOCKED POSITION. IF THIS REVOLVER IS CARELESSLY OR IMPROPERLY HANDLED, AN ACCIDENTAL DISCHARGE COULD RESULT AND COULD CAUSE SERIOUS INJURY, DEATH, OR DAMAGE TO PROPERTY.



Figure 17

DANGEROUS SITUATIONS

 **WARNING:** ALWAYS KEEP THE MUZZLE POINTED IN A SAFE DIRECTION. IF THIS REVOLVER IS CARELESSLY OR IMPROPERLY HANDLED, AN ACCIDENTAL DISCHARGE COULD RESULT AND COULD CAUSE SERIOUS INJURY, DEATH, OR DAMAGE TO PROPERTY.

 **WARNING:** NEVER USE YOUR REVOLVER IF IT FAILS TO FUNCTION PROPERLY, AND NEVER FORCE A CARTRIDGE INTO THE CYLINDER, as a DAMAGED round may explode causing serious injury, possible death, or severe damage to your revolver.

MISFIRE

Although misfires are rarely encountered with properly maintained revolvers and factory ammunition, misfires are potentially dangerous. It is important that proper corrective action be taken rapidly.

A misfire is a failure to fire when the hammer falls due to a mechanism malfunction, faulty cartridge or the chambers need to be cleaned to allow proper seating of the cartridge in the chamber. Keep the muzzle pointed in a safe direction for two minutes with the revolver cylinder closed. This will avoid having the cartridge explode due to a slow burning primer when ejected, preventing injury or possible death. After two minutes unload the revolver as described on [page 31](#). Examine the unfired cartridge; if the firing pin indent appears normal, assume the misfire is the result of faulty ammunition, load another cartridge, and continue to fire. If the firing pin indent is light, misaligned, or nonexistent, check that the chambers are clean and that the cartridge is seated properly before closing the cylinder. Load another cartridge and fire the revolver. If another misfire occurs, have your revolver examined by a competent gunsmith or return it to Colt for service.

NOTE: Dispose of any misfired cartridges in accordance with the ammunition manufacturer's instructions.

BORE OBSTRUCTIONS

 **WARNING:** SNOW, MUD, SAND, OR OTHER OBSTRUCTIONS MUST BE REMOVED FROM THE BARREL BORE BEFORE FIRING. If you attempt to fire with an obstruction in the barrel, it may BULGE or BURST THE BARREL OR CYLINDER AND COULD CAUSE SERIOUS INJURY, DEATH, and OR DAMAGE TO PROPERTY.

1. To remove water, snow, mud, or sand from the barrel, hold the revolver with the muzzle down, open the cylinder and shake the revolver vigorously until the barrel is clear. If necessary use a cleaning rod to clear the barrel.
2. Close the cylinder.
3. The revolver can now be fired.

Note: Clean and lubricate the revolver as soon as possible after clearing any obstruction or whenever it has been exposed to water.

BULLET IN BARREL

If a noticeable difference in sound or recoil is experienced, or if there is any reason to suspect that a bullet is stuck in the barrel, immediately unload the revolver (as described in Actions 1, 2, 3, & 4 on [page 31](#)) and look through the bore, not just in the cylinder. A bullet may be lodged down the barrel and may not be easily seen. If a bullet is stuck in the barrel, bring the revolver to a competent gunsmith to dislodge the bullet.

 **WARNING:** BEFORE LOOKING THROUGH THE BORE, ENSURE THE REVOLVER IS UNLOADED. THE REVOLVER IS CLEAR ONLY WHEN CYLINDER IS EMPTY AND IN THE OPEN POSITION. IF THE REVOLVER IS CARELESSLY OR IMPROPERLY HANDLED, AN ACCIDENTAL DISCHARGE COULD RESULT AND COULD CAUSE SERIOUS INJURY, DEATH, OR DAMAGE TO PROPERTY.

 **WARNING:** IF A BULLET IS STUCK IN THE BARREL, DO NOT ATTEMPT TO SHOOT IT OUT BY USING ANOTHER CARTRIDGE, OR BY BLOWING IT OUT WITH A BLANK, AS DOING SO COULD GENERATE EXCESS PRESSURE, CAUSE DAMAGE TO THE REVOLVER, OR CAUSE SERIOUS PERSONAL INJURY OR DEATH.

HEALTH AND ENVIRONMENTAL

 **WARNING:** DISCHARGING OR CLEANING REVOLVERS OR HANDLING AMMUNITION IN POORLY VENTILATED AREAS MAY RESULT IN EXPOSURE TO LEAD AND OTHER SUBSTANCES KNOWN TO CAUSE BIRTH DEFECTS, REPRODUCTIVE HARM, CANCER, AND OTHER SERIOUS PHYSICAL INJURY. HAVE ADEQUATE VENTILATION AT ALL TIMES. CLEAN HANDS THOROUGHLY AFTER EXPOSURE.

STORAGE

 **CAUTION:** BEFORE STORING YOUR REVOLVER, ENSURE IT IS UNLOADED AND STORE AMMUNITION SEPARATELY.

 **CAUTION:** ALWAYS STORE YOUR REVOLVER IN A MANNER THAT WILL PREVENT ACCESS BY UNAUTHORIZED PERSONS.

 **WARNING:** NEVER STORE OR TRANSPORT A LOADED REVOLVER. SAFE STORAGE AND SECURE TRANSPORTATION OF YOUR REVOLVER IS YOUR RESPONSIBILITY.

Store your revolver and ammunition securely locked in separate locations out of the reach and sight of children and untrained persons to minimize the risk that the revolver will be used by unauthorized persons.

 **CAUTION:** ALWAYS FOLLOW THE LAW. YOUR REVOLVER IS YOUR RESPONSIBILITY.

NOTE: Various federal and state laws and local ordinances may govern the proper storage of firearms, so take the advice of a dealer in your state on how to store your revolver.

SAFETY DEPENDS ON YOU

REVOLVER RECORD

Colt Model Number _____

Serial Number _____

Caliber _____

Purchased From _____

Date Purchased _____



SERIAL NUMBER LOCATION

SERVICE AGREEMENT

Limited One Year Non-Transferable Product Warranty

Colt does not offer an express warranty, but acknowledges implied Magnuson-Moss Act obligations. Accordingly, Colt products will be serviced for defects in original factory materials or workmanship to the original purchaser at no charge for one year from the date of retail purchase from a Colt Stocking Dealer. Cosmetic blemishes and damage from normal wear and tear, abuse, neglect, improper ammunition, or to finishes/coatings are excluded. Be sure to retain your sales slip as proof when making a claim that you are the original purchaser, and of the purchase date and the Colt Stocking Dealer. This limited one year non-transferable warranty replaces all prior warranties or service agreements regardless of their terms or conditions.

This revolver was manufactured by Colt Manufacturing Company LLC. The revolver was designed and built for the heavy user with an emphasis on reliability, accuracy, durability and interchangeability of parts, rather than on cosmetic appearance. As a result, your revolver may have superficial blemishes on the exterior and color variation between parts. These minor imperfections are not defects.

If your revolver has a cosmetic finish, please keep in mind that these finishes are not armor. Sharp objects will scratch and mar them. So will exposure to harsh chemicals or conditions. We do not perform cosmetic corrections on revolver finishes. Expect your revolver's finish to develop its own battle scars through normal wear and tear, particularly to contact areas. These are not defects, but a reflection of your revolver taking on a personality of its own as an extension of you.

SERVICING AND REPAIR

Should your revolver require adjustment or repair, make sure it is NOT LOADED and send it to Colt Manufacturing Company LLC, attention Product Service, 2 Talcott Rd., West Hartford, CT 06110. It is recommended that you contact Product Service at 1-800-962-COLT before shipping, as all returns require a RMA in advance of shipping. (Do not indicate the contents of the package anywhere on the package.)

Before shipping your revolver, here are some points to remember:



CAUTION: MAKE SURE THE REVOLVER IS UNLOADED BEFORE SHIPPING.

- Include a letter explaining the problem and your requirements in as much detail as possible. Include the model name and serial number of your revolver, together with your return address, day time telephone number, and email address, and then enclose the letter with the revolver in a well-padded package.
- Insure the package and its contents against theft or loss.
- Do not send presentation boxes, accessories, or ammunition.

IMPORTANT: If you make unauthorized adjustments or use unauthorized parts in your revolver, Colt will not assume responsibility for the functioning of the revolver.

NOTE: This revolver is manufactured to perform properly with the original parts as designed. It is your duty to make sure any parts you buy are installed correctly and that neither replacements nor originals are altered or changed. That is why we strongly recommend that you have your revolver serviced by Colt. Your revolver is a complex tool with many parts that must relate correctly to other parts. Assembling a revolver wrong or with modified parts can result in a damaged revolver, danger, and injury or death to you and others through malfunction. Always have a qualified gunsmith work on your revolver. Any work that you suspect was not performed by a gunsmith should be checked by a competent gunsmith or returned to Colt for inspection.

NOTE: Various federal and state laws and local ordinances govern the transfer and transportation of firearms, so take the advice of a dealer in your state on how to send or transport your revolver to Colt.

SAFETY DEPENDS ON YOU

NOTES

SAFETY DEPENDS ON YOU

If your instruction manual becomes lost or destroyed, obtain a replacement by downloading one from the Colt website at www.colt.com.



COLT, COLT (stylized "C"), and the Rampant Colt (design) are the exclusive property of New Colt Holding Corp. and licensed to Colt Manufacturing Company LLC. Other trademarks used herein are owned by Colt Manufacturing Company LLC. For permission to reprint for noncommercial instructional purposes, prior approval from Colt Manufacturing Company LLC is required.

This instruction manual should always accompany this revolver. When you lend, give, or sell this revolver, be sure this manual goes with it.

SAFETY DEPENDS ON YOU

FIVE BASIC SAFETY RULES:

1. ALWAYS KEEP THE GUN POINTED IN A SAFE DIRECTION.
2. ALWAYS KEEP YOUR FINGERS OFF THE TRIGGER UNTIL READY TO FIRE.
3. UNLOAD WHEN NOT IN USE.
4. ALWAYS ENSURE A GUN IS NOT LOADED BEFORE CLEANING, DISMANTLING, OR STORING.
5. PRACTICE HANDLING AN EMPTY GUN BEFORE ATTEMPTING TO FIRE.



WARNING: IF THERE IS ANYTHING YOU DO NOT UNDERSTAND, GET HELP FROM SOMEONE QUALIFIED IN THE SAFE HANDLING OF FIREARMS. IF NECESSARY, CONTACT COLT MANUFACTURING COMPANY LLC AT:

Customer Service

P. O. BOX 118
HARTFORD, CT 06141-0118

OR

Product Service

2 Talcott Rd
West Hartford, CT 06110
Tel: 1-800-241-2485
Fax: 1-860-244-1449

E-Mail: CS@colt.com
Webpage: www.colt.com