



Safe ownership is your responsibility. Please thoroughly read and understand this manual before loading your firearm.

Keep firearms and ammunition away from children. Lock unloaded firearms and ammunition securely in separate locations.

This manual should always accompany your firearm and be transferred with it upon change of ownership. This is your responsibility and may protect you from future liability.

100 Springdale Road  
Westfield, MA 01085

## INSTRUCTION MANUAL

# BOLT ACTION SHOTGUNS

**IMPORTANT! DO NOT ATTEMPT TO LOAD AND SHOOT YOUR RIFLE UNTIL YOU HAVE THOROUGHLY READ THIS INSTRUCTION MANUAL AND ARE FULLY FAMILIAR WITH ITS CONTENTS**

For more information, please visit our web site at [www.savagearms.com](http://www.savagearms.com)

Download a QR Code reader app for your Smartphone  
then snap this to open Savage Arms' homepage



[WWW.SAVAGEARMS.COM](http://WWW.SAVAGEARMS.COM)

**BOLT ACTION SHOTGUNS  
Model 212 and Model 220**

Congratulations on the purchase of your new firearm. You are now part of the Savage Sports Corporation family of quality firearms and accessories, which includes Savage Arms, Inc., Savage Arms (Canada), Stevens and Fox. With reasonable care, your firearm should deliver years of reliable service and perform to our "definition of accuracy".

**THIS MANUAL IS EXTREMELY IMPORTANT.**

The safety warnings and instructions in this manual are very important. By understanding the dangers involved in the use of any firearm and by taking the necessary precautions, you can use your Savage firearm in complete safety. However, failure to read, understand, and obey any of the warnings may result in serious injury or death to you or others, as well as severe damage to the firearm or other property.

This manual should always accompany your firearm and be transferred with it upon change of ownership. This is your responsibility and may protect you from future liability.

**Savage Arms offers firearms designed in two ways: SIDE BOLT RELEASE and BOTTOM BOLT RELEASE. It is important to identify which firearm you have purchased and follow the appropriate section in the INSTRUCTION MANUAL. There are major differences between the two (i.e. bolt installation, stock removal/installation, etc) and it is the user's responsibility to read and understand them**

**in their entirety. IF YOU USE IT IMPROPERLY – IT WILL NOT WORK. MORE IMPORTANTLY, IF YOU USE IT IMPROPERLY – SOMEONE MAY BE SERIOUSLY INJURED. IN BOTH CASES, THE KEY WORD IS YOU!**

For your convenience, SECTION 3 describes the bottom bolt release on the Model 212 and SECTION 4 describes the side bolt release on the Model 220. All of the other sections are common for both shotguns.

SECTION 1: Safety First – It's Your Responsibility!	p. 2
SECTION 2: Three Position Safety	p. 4
SECTION 3: MODEL 212 (BOTTOM BOLT RELEASE)	p. 6
- Installing and Removing the Bolt Assembly	
- Cocking Indicator	
- Removing/Installing the Stock	
SECTION 4: MODEL 220 (SIDE BOLT RELEASE)	p. 8
- Installing and Removing the Bolt Assembly	
- Cocking Indicator	
- Removing/Installing the Stock	
SECTION 5: Loading / Unloading / Firing	p. 10
SECTION 6: AccuTrigger Adjustment	p. 13
SECTION 7: PARTS LIST AND DIAGRAM	p. 14
- Model 212	
- Model 220	

SECTION 8: Ammunition Bullet Weights / Magazine Capacities	p. 19
SECTION 9: Rings and Bases for Mounting a Scope	p. 19
SECTION 10: Maintenance	p. 20
- Routine Maintenance	
- Cleaning	
SECTION 11: Statement of Limited Warranty	p. 21

Although considerable time and effort were put into assuring the accuracy of the information contained herein, human errors do occur. If an error is found, please let us know. As a 'customer driven' company, we appreciate and encourage feedback.

The following patents apply to the firearms contained in this manual: AccuTrigger™ - patent number US 6,553,706B1.

## SECTION 1 – SAFETY FIRST – IT'S YOUR RESPONSIBILITY

Above all – remember that a firearm is a mechanical device. It can not think, it can not act on its own – it only does what YOU MAKE IT DO. A mechanical device has no way to know if your actions are safe or if they will result in injury or death – THAT'S YOUR PART! It only takes one careless second to result in a tragedy that you will have to live with the rest of your life. MAKE NO DOUBT ABOUT IT, owning and/or using a firearm puts YOU in full control of its actions and THEIR CONSEQUENCES!

### 10 COMMANDMENTS OF SHOOTING SAFETY

FOR MORE INFORMATION, PLEASE VISIT OUR WEB SITE AT: [WWW.SAVAGEARMS.COM](http://WWW.SAVAGEARMS.COM)

(The following excerpts are from SAAMI bulletin #081 1MM 7/97 BP. The entire booklet can be obtained by contacting: NATIONAL SHOOTING SPORTS FOUNDATION, 11 MILE HILL ROAD, NEWTOWN, CT 06470)

### FIREARMS SAFETY DEPENDS ON YOU!

**FROM THE TIME YOU PICK UP A FIREARM, YOU BECOME PART OF A SYSTEM OVER WHICH YOU HAVE COMPLETE CONTROL. YOU ARE THE ONLY PART OF THE SYSTEM THAT CAN MAKE A GUN SAFE – OR UNSAFE.**

You can help meet this responsibility by enrolling in hunter safety or shooter safety courses, if you

have not already done so. You must constantly stress safety when handling firearms, especially to children and non-shooters. Develop safe shooting habits and remember, firearms safety is up to you. Make no mistake about it.

### **ALCOHOL, DRUGS AND GUNS DON'T MIX**

#### **1. ALWAYS KEEP THE MUZZLE POINTED IN A SAFE DIRECTION**

This is the most basic safety rule. If everyone handled a firearm so carefully that the muzzle never pointed at something they didn't intend to shoot, there would be virtually no firearm accidents. It's as simple as that, and it's up to you.

Never point your gun at anything you do not intend to shoot. A safe direction means a direction in which a bullet cannot possibly strike anyone, taking into account possible ricochets and the fact that bullets can penetrate walls and ceilings. Even when "dry firing" with an unloaded gun, you should never point the gun at an unintended target.

This is your responsibility, and only you can control it.

#### **2. FIREARMS SHOULD BE UNLOADED WHEN NOT ACTUALLY IN USE**

Firearms should be loaded only when you are in the field or on the target range or shooting area, ready to shoot. When not in use, firearms and ammunition should be secured in a safe place, separate from each other. It is your responsibility to prevent children and inexperienced adults from gaining access to

firearms or ammunition. A loaded gun has no place in or near a vehicle or building.

Whenever you handle a firearm or hand it to someone, always open the action immediately, and visually check the chamber, receiver and magazine to be certain they do not contain any ammunition. Never assume a gun is unloaded – check for yourself! While in the field, there will be times when common sense and the basic rules of firearms safety will require you to unload your gun for maximum safety. When in doubt, unload your gun!

#### **3. DON'T RELY ON YOUR GUN'S "SAFETY"**

Treat every gun as though it can fire at any time, regardless of pressure on the trigger. The "safety" on any gun is a mechanical device, which, like any such device, can become inoperable at the worst possible time. The safety serves as a supplement to proper gun handling but cannot possibly serve as a substitute for common sense.

Never touch the trigger on a firearm until you actually intend to shoot.

Your firearm is a precision instrument. Regardless of the position of the safety, any bump strong enough to actuate the firing mechanism of a gun can cause it to fire. The only time you can be absolutely certain that a gun cannot fire is when the action is open and it is completely empty. You and the safe gun handling procedures you have learned are your gun's primary safeties.

#### **4. BE SURE OF YOUR TARGET AND WHAT'S BEYOND IT**

No one can call a bullet back. Don't shoot unless you know exactly what your bullet is going to strike. Be sure that your bullet will not injure anyone or anything beyond your target. You should keep in mind how far a bullet will travel if it misses your intended target or ricochets in another direction.

Be aware that even a .22 short bullet can travel over 1¼ miles and a high velocity shell, such as a 30-06, can project a bullet more than 3 miles. Shotgun pellets can travel 500 yards, and shotgun slugs have a range of over a half-mile.

#### **5. USE CORRECT AMMUNITION**

You must assume the serious responsibility of using only the correct ammunition for your firearm. Read and heed all warnings, including those that appear in the gun's instruction manual and on the ammunition boxes. Using improper or incorrect ammunition can destroy a gun and cause serious personal injury. It only takes one shell of improper caliber or gauge to wreck your gun, and only a second to check each one as you load it. Be absolutely certain that the ammunition you are using matches the specifications that are contained within the gun's instruction manual and the manufacturer's markings on the firearm barrel.

Hand loaded or reloaded ammunition deviating from pressures generated by factory loads or from competent recommendations specified in

reputable hand loading manuals can be dangerous, and can cause severe damage to guns and serious injury to the shooter.

Ammunition that has become very wet or has been submerged in water should be discarded in a safe manner. Do not spray oil or solvents on ammunition or place ammunition in excessively lubricated firearms.

Form the habit of examining every shell you put in your gun. Never use damaged, old or questionable ammunition – the money you save is not worth the risk of possible injury or a ruined gun.

***DISCHARGING FIREARMS IN POORLY VENTILATED AREAS, CLEANING FIREARMS OR HANDLING AMMUNITION MAY RESULT IN EXPOSURE TO LEAD AND OTHER SUBSTANCES KNOWN TO CAUSE BIRTH DEFECTS, REPRODUCTIVE HARM AND OTHER SERIOUS PHYSICAL INJURY. HAVE ADEQUATE VENTILATION AT ALL TIMES. WASH HANDS THOROUGHLY AFTER EXPOSURE.***

#### **6. IF YOUR GUN FAILS TO FIRE WHEN THE TRIGGER IS PULLED, HANDLE WITH CARE!**

Occasionally, a loaded gun may not fire when the trigger is pulled. If this occurs, keep the muzzle pointed in a safe direction. Keep your face away from the breech. Then, carefully open the action, unload the firearm and dispose of the shell in a safe way.

Any time there is a shell in the chamber, your gun is loaded and ready to fire - even if you've tried to shoot and it did not go off. It could go off at any time, so you must always remember **RULE #1** and **WATCH THAT MUZZLE!**

#### **7. ALWAYS WEAR EYE AND EAR PROTECTION WHEN SHOOTING**

All shooters should wear protective shooting glasses and some form of hearing protectors while shooting. Exposure to shooting noise can damage hearing, and adequate vision protection is essential. Wearing eye protection when disassembling and cleaning any gun will also help prevent the possibility of springs, spring tensioned parts, solvents or other agents from contacting your eyes. No target shooter, plinker or hunter should ever be without them.

#### **8. BE SURE THE BARREL IS CLEAR OF OBSTRUCTIONS BEFORE SHOOTING**

Before you load your firearm, open the action and be certain that there is no shell in the chamber. Then glance through the barrel to be sure it is clear of any obstruction. Even a small bit of mud, snow, excess lubricating oil or grease in the bore can cause dangerously increased pressure, causing the barrel to bulge or even burst when firing, which can cause injury to the shooter and bystanders. Make it a habit to clean the bore with a cleaning rod and patch to wipe away anti-rust compounds in the gun each time immediately before you shoot it. If the noise or recoil on firing seems weak or doesn't seem quite

“right”, cease firing immediately and be sure to check that no obstruction or projectile has become lodged in the barrel.

### **9. DON'T ALTER OR MODIFY YOUR GUN, AND HAVE GUNS SERVICED REGULARLY**

Firearms are complicated mechanisms, which are designed by experts to function properly in their original condition. Any alteration or change (other than adjusting the AccuTrigger™) made to a firearm after manufacture can make the gun dangerous and will usually void any factory warranties. Do not jeopardize your safety or the safety of others by altering the trigger, safety or other mechanism of any firearm or allowing unqualified person's to repair or modify a gun.

Your gun is a mechanical device, which will not last forever and is subject to wear. As such, it requires periodic inspection, adjustment and service.

### **10. LEARN THE MECHANISM AND HANDLING CHARACTERISTICS OF THE FIREARM YOU ARE USING**

Not all firearms are the same. Consequently, never handle any firearm without first having thoroughly familiarized yourself with the particular type of firearm you are using, the safe gun handling rules for loading, unloading, carrying and handling that firearm, and the rules of safe gun handling in general. Locate the firearm's mechanical safety device and get familiar with the feel and “on/off” positions.

You should always read and refer to the instruction manual you received with your gun, or if you have misplaced the manual, simply contact the manufacturer for a free copy.

Having a gun in your possession is a full-time job. You cannot guess; you cannot forget. You must know how to use, handle, and store your firearm safely. Do not use any firearm without having a complete understanding of its particular characteristics and safe use. There is no such thing as a foolproof gun.

## **SECTION 2 – THREE POSITION SAFETY**

FOR MORE INFORMATION, PLEASE VISIT OUR WEB SITE AT: [WWW.SAVAGEARMS.COM](http://WWW.SAVAGEARMS.COM)

***PRIOR TO LOADING OR OPERATING, FAMILIARIZE YOURSELF THOROUGHLY WITH THESE OPERATING INSTRUCTIONS AND THE MAIN PARTS OF YOUR FIREARM.***

***YOUR GUN IS A MECHANICAL DEVICE WHICH WILL NOT LAST FOREVER AND IS SUBJECT TO WEAR. WHEN SOMETHING DOES NOT SOUND, FEEL, OR LOOK RIGHT, SEEK THE ADVICE OF A PROFESSIONAL GUNSMITH IMMEDIATELY. NEVER TAKE A CHANCE.***

***FAILURE TO OBEY A SAFETY WARNING MAY RESULT IN INJURY TO YOU OR OTHERS.***

***KNOW HOW TO LOCATE AND OPERATE THE SAFETY MECHANISM.***

***THOROUGHLY CLEAN THE INSIDE OF THE BARREL AND CHAMBER PRIOR TO LOADING WITH AMMUNITION.***

***THE USE OF RELOADS, HANDLOADS, MILITARY SURPLUS, OR ANY OTHER COMMERCIAL/ NONCOMMERCIAL AMMUNITION NOT MANUFACTURED TO SAAMI (SPORTING ARMS AND AMMUNITION MANUFACTURERS' INSTITUTE, INC.)/ ANSI (AMERICAN NATIONAL STANDARDS INSTITUTE) SPECIFICATIONS WILL VOID THE WARRANTY.***

**ALWAYS BE SURE THE FIREARM (ESPECIALLY THE END OF THE BARREL) IS FREE AND CLEAR OF ANY OBSTRUCTIONS THAT MAY RESTRICT (OR SLOW DOWN) THE BULLET FROM LEAVING THE MUZZLE AT ITS NORMAL RATE OF SPEED. THIS INCLUDES SNOW, WATER, BRUSH, SHRUBS, STICKS, LEAVES AND DEBRIS TO NAME A FEW. NEVER PLACE THE END OF A BARREL OR SUBMERGE A FIREARM UNDER WATER. RESTRICTING, SLOWING, OR STOPPING THE BULLET FROM LEAVING THE MUZZLE WILL CREATE AN EXCESSIVE AMOUNT OF PRESSURE TO BUILD UP BEHIND IT AND MAY LEAD TO EXTENSIVE DAMAGE TO THE FIREARM AND PERSONAL INJURY TO THE SHOOTER AND/OR BYSTANDERS. SAFE OPERATION IS YOUR RESPONSIBILITY AND CAN ONLY BE CONTROLLED BY YOU!**

**KNOW EXACTLY WHERE YOU ARE POINTING THE BARREL OF A FIREARM AND WHY!**

**IT IS SO IMPORTANT TO STRESS THAT A FIREARM IS NO MORE THAN AN ASSEMBLY OF MANY DIFFERENT COMPONENTS – A MECHANICAL DEVICE. AS SUCH, YOU ARE THE ONLY SAFETY MECHANISM THAT CAN PREVENT AN ACCIDENT.**

The safety on your Savage Arms shotgun has 3 positions:

- **FULL SAFE** - Pull safety button towards shooter (trigger blocked – bolt cannot be opened).

- **MID POSITION** (trigger blocked – bolt can be opened).
- **SAFETY OFF - READY TO FIRE.** Push safety button away from shooter.

#### **FULL SAFE**

1. The safety is in the FULL SAFE position when it has been moved fully rearward, covering the red "F" (See FIGURE 1).
2. The safety should be moved into the FULL SAFE position when the bolt has been closed and the firearm is ready to fire.
3. In the FULL SAFE position, the trigger is blocked from moving and the bolt cannot be opened.



**FIGURE 1**

**WHEN THE BOLT IS FULLY FORWARD AND THE BOLT HANDLE UP ON THE MODEL 212, THE BOLT CAN NOT BE PULLED REARWARD WITH THE SAFETY IN THE FULL SAFE POSITION.**

**WHEN CARRYING A LOADED FIREARM, THE SAFETY MUST ALWAYS BE IN THE FULL SAFE POSITION.**

**THE ONLY TIME YOU CAN BE ABSOLUTELY CERTAIN THAT A GUN CANNOT FIRE IS WHEN THE ACTION IS OPEN AND IT IS COMPLETELY EMPTY OF AMMUNITION.**

#### **MID POSITION ON THE MODEL 212:**

MID POSITION ALLOWS THE BOLT TO BE OPENED AND CYCLED WHILE STILL BLOCKING THE TRIGGER

1. Move the safety fully forward to the SAFETY OFF – READY TO FIRE position.
2. Carefully and deliberately move the safety slightly rearward to the MID SAFE detent.
3. With slight pressure on your thumb, gently rock the safety to be sure you are in the MID SAFE detent.

#### **MID POSITION ON THE MODEL 220:**

MID POSITION ALLOWS THE BOLT TO BE OPENED AND CYCLED WHILE STILL BLOCKING THE TRIGGER

1. The safety will move to the MID POSITION when the following sequence is performed
  - lift the bolt handle
  - move the safety to the FULL SAFE position
  - push the bolt handle downward

**WHEN IN DOUBT – NEVER ASSUME! WITH THE BOLT HANDLE FULLY UPWARD – THE**

**BOLT PULLED TO THE REAR - THE MUZZLE POINTED IN A SAFE DIRECTION - THE SAFETY IN THE MID SAFE POSITION, THE TRIGGER SHOULD NOT HAVE ANY REARWARD MOVEMENT.**

### **SAFETY OFF – READY TO FIRE**

1. The safety is in the OFF position when moved fully forward, exposing the red “F” (see insert in FIGURE 2).



**FIGURE 2**

**NEVER TRANSPORT/CARRY A LOADED FIREARM WITH THE SAFETY OFF.**

## **SECTION 3 – MODEL 212 (BOTTOM BOLT RELEASE)**

### **INSTALLING AND REMOVING THE BOLT ASSEMBLY**

**BOLT ASSEMBLIES ARE SPECIFICALLY MATCHED TO A FIREARM. USING ANY OTHER BOLT ASSEMBLY MAY CAUSE EXTENSIVE DAMAGE TO THE FIREARM AND/OR SERIOUS INJURY TO THE SHOOTER OR BYSTANDER.**

**CERTAIN FIREARMS ARE SHIPPED WITH THE BOLT REMOVED AND PACKED IN A SEPARATE COMPARTMENT WITHIN THE BOX. BEFORE INSTALLING THE BOLT, VERIFY THAT THE 4 DIGITS ENGRAVED BY THE EXTRACTOR MATCH THE LAST 4 DIGITS OF THE SERIAL NUMBER ON THE RECEIVER.**

***BE SURE THERE IS NO AMMUNITION IN EITHER THE CHAMBER OR MAGAZINE.***

### **BOLT INSTALLATION (SEE FIGURE 3)**

1. Rotate the FRONT BAFFLE (1) to line-up the BOLT GUIDE with the EXTRACTOR.
2. Pull the TRIGGER (2) fully rearward and hold it in that position.
3. **WITH NO AMMUNITION IN THE FIREARM**, insert the BOLT (3) into the firearm, pushing it forward.
4. Close the BOLT HANDLE (pushing downward) and verify that the “THREE POSITION SAFETY” is operational as explained in SECTION 2 of this manual.

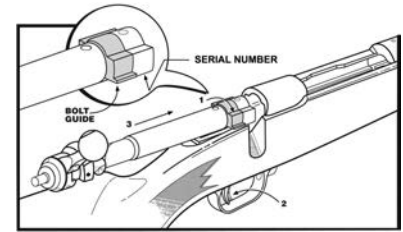

**FIGURE 3**

### **BOLT REMOVAL – BOTTOM BOLT RELEASE** (see FIGURE 4)

1. With the muzzle pointed in a safe direction, move the safety forward to the SAFETY OFF – READY TO FIRE position.
2. Lift the bolt handle and pull fully to the rear.
3. **WITH NO AMMUNITION IN THE FIREARM**, pull the TRIGGER (1) fully rearward and hold it in that position.
4. Push the BOLT RELEASE (2) as far as it will go into the trigger guard.
5. Grasping the BOLT HANDLE, pull the bolt assembly fully rearward until it clears the receiver. If it seems to bind or stop, be sure that the trigger has been pulled fully rearward first and then the BOLT RELEASE pushed as far as it will go into the trigger guard.



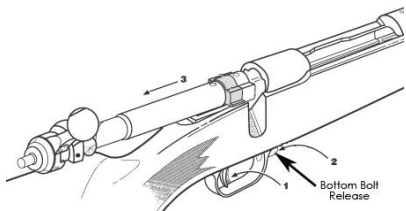

FIGURE 4

### **COCKING INDICATOR**

***THE MAIN PURPOSE OF THE COCKING INDICATOR IS TO VISUALLY SHOW WHEN THE FIREARM IS COCKED. THIS IS NOT A LOADED CHAMBER INDICATOR NOR A SAFETY DEVICE WHICH CAN BE RELIED ON TO PREVENT ACCIDENTAL DISCHARGE – THAT RESPONSIBILITY LIES SOLELY IN THE HANDS OF THE SHOOTER!***

1. Cocked – when the tip of the indicator is protruding or even with the rear of the bolt (see FIGURE 5).



FIGURE 5

2. Uncocked – when the tip of the indicator is not protruding or even with the end of the bolt (see FIGURE 6).



FIGURE 6

### **REMOVING THE STOCK**

***BE SURE THE BOLT IS OPEN AND THERE IS NO LIVE AMMUNITION IN EITHER THE CHAMBER OR MAGAZINE. LOOK AND FEEL WITH YOUR FINGER – THERE SHOULD BE NO DOUBT – THERE SHOULD BE NO QUESTION – THERE MUST BE NO AMMUNITION IN EITHER THE CHAMBER OR MAGAZINE!***

***THE ONLY TIME YOU CAN BE ABSOLUTELY CERTAIN THAT A GUN CANNOT FIRE IS WHEN THE ACTION IS OPEN AND IT IS COMPLETELY EMPTY OF AMMUNITION.***

1. Check again to be sure there is no ammunition in either the chamber or magazine.
2. With the muzzle pointed in a safe direction, close the bolt and pull the trigger (dry fire).

***THE BOLT MUST REMAIN CLOSED AND THE ACTION UNCOCKED ('FIRED') THROUGHOUT***

### ***THE ENTIRE PROCEDURE OF REMOVING THE STOCK AND THEN REINSTALLING THE ACTION.***

3. Turn the firearm upside down, with the muzzle pointed away from you.
4. Remove the detachable box magazine.
5. Using a 5/32" Allen wrench, loosen and remove the two action screws securing the stock (see FIGURE 7).

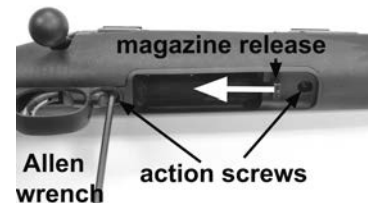

FIGURE 7

6. Remove the stock.

### **INSTALLING THE STOCK**

***BE SURE THE BOLT IS STILL CLOSED AND THE ACTION UNCOCKED ('FIRED') PRIOR TO PUTTING THE STOCK BACK ON. IF THE BOLT RELEASE BUTTON IS JAMMED AFTER INSTALLING THE ACTION, PERFORM THE FOLLOWING STEPS: REMOVE THE ACTION SCREWS, REMOVE THE ACTION, LIFT THE BOLT HANDLE AND THEN CLOSE IT (TO COCK THE ACTION), POINT THE MUZZLE IN A SAFE DIRECTION, PULL THE TRIGGER (DRY FIRE), AND THEN REINSERT THE ACTION BACK INTO THE STOCK.***

1. Remove the magazine prior to reassembling the stock.
2. Place the action onto the stock, being careful to align the trigger with the trigger slot in the stock.
3. Install the action screws (longer screw is to the rear and the shorter screw is to the front) into the stock and turn the wrench clockwise until the threads of the screws just engage into the receiver. **DO NOT OVER TIGHTEN** – the stock must be loose at this step!
4. Carefully lift the firearm up so that the recoil pad is sitting on a solid surface and the barrel is pointing upward.
5. Putting downward pressure on the barrel to seat the recoil lug firmly in the stock, tighten the front action screw first and then the rear action screw securely.

**KNOW YOUR GUN! IF ANYTHING ‘FEELS’ OR SOUNDS DIFFERENT - STOP - AND HAVE A QUALIFIED GUNSMITH TAKE A LOOK! NEVER TAKE A CHANCE WITH SOMETHING THAT YOU ARE UNSURE OF ... ALWAYS ASK A PROFESSIONAL.**

6. Cycle the bolt several times to be sure that it functions properly. If you are unable to close the bolt handle completely, the action screws are reversed.

**AFTER REASSEMBLING THE STOCK, VERIFY THAT THE SAFETY OPERATES CORRECTLY IN ALL 3 POSITIONS AS DEFINED IN SECTION 2 – ‘THREE POSITION SAFETY’ OF THIS MANUAL. SAFE OWNERSHIP IS YOUR RESPONSIBILITY!**

## SECTION 4 – MODEL 220 (SIDE BOLT RELEASE)

### INSTALLING AND REMOVING THE BOLT ASSEMBLY

**BOLT ASSEMBLIES ARE SPECIFICALLY MATCHED TO A FIREARM. USING ANY OTHER BOLT ASSEMBLY MAY CAUSE EXTENSIVE DAMAGE TO THE FIREARM AND/OR SERIOUS INJURY TO THE SHOOTER OR BYSTANDER.**

**CERTAIN FIREARMS ARE SHIPPED WITH THE BOLT REMOVED AND PACKED IN A SEPARATE COMPARTMENT WITHIN THE BOX. BEFORE INSTALLING THE BOLT, VERIFY THAT THE 4 DIGITS ENGRAVED BY THE EXTRACTOR MATCH THE LAST 4 DIGITS OF THE SERIAL NUMBER ON THE RECEIVER.**

**BE SURE THERE IS NO AMMUNITION IN EITHER THE CHAMBER OR MAGAZINE.**

**BOLT INSTALLATION (SEE FIGURE 8)**

1. Rotate the FRONT BAFFLE (1) to line-up the BOLT GUIDE with the EXTRACTOR.
2. Pull the TRIGGER (2) fully rearward and hold it in that position.
3. Press down on the COCKING INDICATOR (3) – also known as the “SIDE BOLT RELEASE”
4. **WITH NO AMMUNITION IN THE FIREARM**, insert the BOLT (4) into the firearm, pushing it forward.

5. Close the BOLT HANDLE (pushing downward) and verify that the “THREE POSITION SAFETY” is operational as explained in SECTION 2 of this manual.

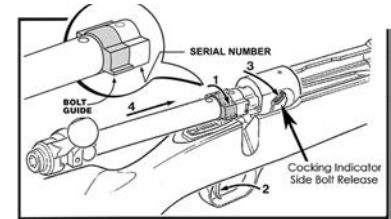

FIGURE 8

**BOLT REMOVAL (see FIGURE 9)**

1. With the muzzle pointed in a safe direction, move the safety forward to the SAFETY OFF – READY TO FIRE position.
2. Lift the bolt handle and pull fully to the rear.
3. **WITH NO AMMUNITION IN THE FIREARM**, pull the TRIGGER (1) fully rearward and hold it in that position.
4. Push the COCKING INDICATOR (2) – also known as the “SIDE BOLT RELEASE” as far down as it will go.
5. Grasping the BOLT HANDLE, pull the bolt assembly fully rearward until it clears the receiver. If it seems to bind or stop, be sure that the trigger has been pulled fully rearward first and then the COCKING INDICATOR pushed as far down as it will go.

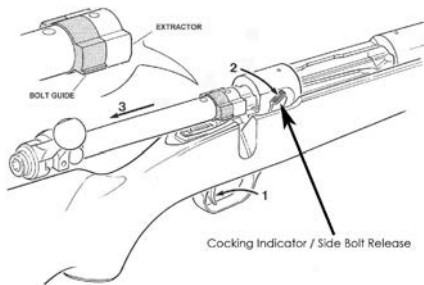

FIGURE 9

### COCKING INDICATOR

**SAVAGE ARMS HAS DESIGNED INTO THE CENTERFIRE BOLT ACTION SERIES, A COCKING INDICATOR. ITS MAIN PURPOSE IS TO VISUALLY INDICATE WHEN THE FIREARM IS COCKED. THIS IS NOT A LOADED CHAMBER INDICATOR NOR A SAFETY DEVICE WHICH CAN BE RELIED ON TO PREVENT ACCIDENTAL DISCHARGE – THAT RESPONSIBILITY LIES SOLELY IN THE HANDS OF THE SHOOTER!**

1. Cocked – when the 'corner' of the indicator is above the stock (see FIGURE 10).



FIGURE 10

2. Uncocked – when the indicator is almost level with the stock and approximately midway on the flat of the receiver (see FIGURE 11).

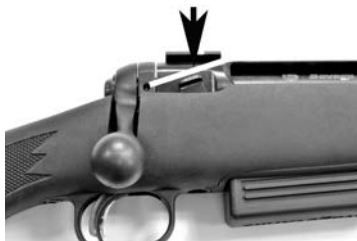

FIGURE 11

### REMOVING THE STOCK

***BE SURE THE BOLT IS OPEN AND THERE IS NO LIVE AMMUNITION IN EITHER THE CHAMBER OR MAGAZINE. LOOK AND FEEL WITH YOUR FINGER – THERE SHOULD BE NO DOUBT – THERE SHOULD BE NO QUESTION – THERE MUST BE NO AMMUNITION IN EITHER THE CHAMBER OR MAGAZINE!***

***THE ONLY TIME YOU CAN BE ABSOLUTELY CERTAIN THAT A GUN CANNOT FIRE IS WHEN THE ACTION IS OPEN AND IT IS COMPLETELY EMPTY OF AMMUNITION.***

1. Check again to be sure there is no ammunition in either the chamber or magazine.
2. Remove the detachable box magazine.
3. Turn the firearm upside down, with the muzzle pointed away from you.
4. Using a 5/32" Allen wrench, loosen and remove the two screws securing the stock (see FIGURE 12).



FIGURE 12

5. Remove the stock.

## **INSTALLING THE STOCK**

1. Remove the magazine prior to reassembling the stock.
2. Place the action onto the stock, being careful to align the trigger with the trigger slot in the stock.
3. Install the action screws (longer screw is to the rear and the shorter screw is to the front) into the stock and turn the wrench clockwise until the threads of the screws just engage into the receiver. **DO NOT OVER TIGHTEN** – the stock must be loose at this step!
4. Carefully lift the firearm up so that the recoil pad is sitting on a solid surface and the barrel is pointing upward.
5. Putting downward pressure on the barrel to seat the recoil lug firmly in the stock, tighten the front action screw first and then the rear action screw securely.

**KNOW YOUR GUN! IF ANYTHING ‘FEELS’ OR SOUNDS DIFFERENT - STOP - AND HAVE A QUALIFIED GUNSMITH TAKE A LOOK! NEVER TAKE A CHANCE WITH SOMETHING THAT YOU ARE UNSURE OF ... ALWAYS ASK A PROFESSIONAL.**

6. Cycle the bolt several times to be sure that it functions properly. If you are unable to close the bolt handle completely, the action screws are reversed.

**AFTER REASSEMBLING THE STOCK, VERIFY THAT THE SAFETY OPERATES CORRECTLY IN ALL 3 POSITIONS AS DEFINED IN**

**SECTION 2 – ‘THREE POSITION SAFETY’ OF THIS MANUAL. SAFE OWNERSHIP IS YOUR RESPONSIBILITY!**

## **SECTION 5 – LOADING / UNLOADING / FIRING**

### **LOADING**

**FIREARMS SHOULD BE LOADED ONLY WHEN YOU ARE IN THE FIELD, ON THE TARGET RANGE, OR AT A SHOOTING AREA READY TO SHOOT.**

**ALWAYS KEEP THE MUZZLE POINTED IN A SAFE DIRECTION.**

**USE ONLY THE CORRECT AMMUNITION THAT IS INDICATED (STAMPED) ON THE SIDE OF THE BARREL.**

**THOROUGHLY CLEAN THE INSIDE OF THE BARREL AND CHAMBER PRIOR TO LOADING WITH AMMUNITION.**

**ALWAYS BE SURE THE FIREARM (ESPECIALLY THE END OF THE BARREL) IS FREE AND CLEAR OF ANY OBSTRUCTIONS THAT MAY RESTRICT (OR SLOW DOWN) THE BULLET FROM LEAVING THE MUZZLE AT ITS NORMAL RATE OF SPEED. THIS INCLUDES SNOW, WATER, BRUSH, SHRUBS, STICKS, LEAVES AND DEBRIS TO NAME A FEW. NEVER PLACE THE END OF A BARREL OR SUBMERGE A FIREARM UNDER WATER. RESTRICTING, SLOWING, OR STOPPING THE BULLET FROM LEAVING THE MUZZLE WILL CREATE AN EXCESSIVE AMOUNT OF PRESSURE TO BUILD UP BEHIND IT AND MAY LEAD TO EXTENSIVE DAMAGE TO THE FIREARM AND PERSONAL INJURY TO THE**

**SHOOTER AND/OR BYSTANDERS. SAFE OPERATION IS YOUR RESPONSIBILITY AND CAN ONLY BE CONTROLLED BY YOU!**

**THE USE OF RELOADS, HANDLOADS, MILITARY SURPLUS, OR ANY OTHER COMMERCIAL/ NONCOMMERCIAL AMMUNITION NOT MANUFACTURED TO SAAMI (SPORTING ARMS AND AMMUNITION MANUFACTURERS' INSTITUTE, INC.)/ANSI (AMERICAN NATIONAL STANDARDS INSTITUTE) SPECIFICATIONS WILL VOID THE WARRANTY.**

**KNOW YOUR GUN! IF ANYTHING 'FEELS' OR SOUNDS DIFFERENT WHEN LOADING OR SHOOTING - STOP - AND HAVE A QUALIFIED GUNSMITH TAKE A LOOK! NEVER TAKE A CHANCE WITH SOMETHING THAT YOU ARE UNSURE OF ... ALWAYS ASK A PROFESSIONAL.**

1. With the muzzle pointed in a safe direction, move the safety forward to the SAFETY OFF – READY TO FIRE position.
2. Lift the bolt handle but do not pull to the rear.
3. With one hand prepared to catch the detachable box magazine, push the magazine release button on the bottom of the stock rearward (see FIGURE 12).

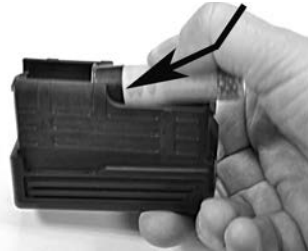

**FIGURE 13**

4. As shown in FIGURE 13, load the correct caliber shells into the detachable box magazine by pressing downward and sliding to the rear, filling the magazine to capacity (see SECTION 8 – AMMUNITION BULLET WEIGHTS/MAGAZINE CAPACITIES).
5. Insert the detachable box magazine back into the stock opening by engaging the **rear first** and then pressing **upward on the front** until the latch is fully engaged.
6. Moving the bolt handle forward will push the first shell from the detachable box magazine into the chamber.

**WHEN THE BOLT IS FULLY CLOSED, A LIVE SHELL WILL BE IN THE CHAMBER.**

**CLOSE THE BOLT SLOWLY TO BE SURE THE SHELL IS ALIGNED WITH THE CHAMBER. IF RESISTANCE IS FELT OR THE BOLT**

**DOES NOT CLOSE, PULL REARWARD ON THE BOLT HANDLE, OPENING THE ACTION. CAREFULLY INSPECT THE BODY AND TIP OF THE SHELL TO BE SURE IT HAS NOT BEEN DAMAGED, REINSERT IN THE MAGAZINE, AND CLOSE THE BOLT. IF IT HAPPENS AGAIN, TRY A NEW SHELL. IF THE PROBLEM PERSISTS, CALL SAVAGE ARMS – CUSTOMER SERVICE.**

**ALWAYS KEEP THE MUZZLE POINTED IN A SAFE DIRECTION.**

7. Move the safety fully rearward to the FULL SAFE position, locking the bolt handle

**TO LOAD A SINGLE SHELL INTO THE CHAMBER**

1. With the muzzle pointed in a safe direction, insert a shell into the chamber as shown in FIGURE 14.
2. Depressing the shells in the magazine with one hand, slowly push the bolt forward allowing it to slide over the top of the shells in the magazine.
3. Push the bolt handle down then immediately move the safety fully rearward to the FULL SAFE position.

**WHEN THE BOLT IS FULLY CLOSED, A LIVE SHELL WILL BE IN THE CHAMBER.**

**ALWAYS KEEP THE MUZZLE POINTED IN A SAFE DIRECTION.**

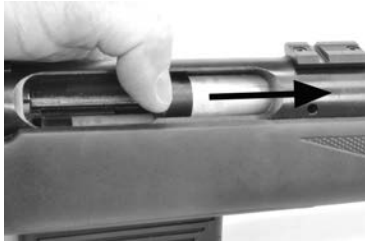

FIGURE 14

### **TO FIRE**

**THE SAVAGE ARMS' ACCUTRIGGER IS A SPECIALLY DESIGNED USER ADJUSTABLE TRIGGER. IT IS THE SOLE RESPONSIBILITY OF THE SHOOTER TO EXERCISE EXTREME CARE WHILE ADJUSTING/HANDLING THESE FIREARMS. SAVAGE ARMS ACCEPTS NO RESPONSIBILITY/ LIABILITY FOR ANY DIRECT AND/OR CONSEQUENTIAL DAMAGE AND/OR INJURY RESULTING FROM THE MIS-USE AND/OR MISHANDLING OF A FIREARM. AS WITH ANY PRECISION TUNED MECHANICAL DEVICE, PERIODIC INSPECTION/MAINTENANCE IS REQUIRED – AND YOUR RESPONSIBILITY!**

**WITH SAFETY AS OUR PRIMARY CONCERN, THE ACCUTRIGGER DESIGN REQUIRES THE SHOOTER TO PLACE THEIR FINGER SQUARELY OVER THE ACCURELEASE. PULLING THE TRIGGER FROM THE SIDE OR NOT DIRECTLY REARWARD WILL CAUSE**

**THE SEAR TO DISENGAGE AND BE BLOCKED BY THE ACCURELEASE. ALTHOUGH A 'CLICK' MAY BE HEARD, THE SEAR IS BLOCKED, PREVENTING THE FIRING PIN FROM HITTING THE PRIMER. WHEN THIS HAPPENS, THE BOLT MUST BE RAISED AND LOWERED TO 'RECOCK' THE FIREARM.**

**DO NOT MOVE THE SAFETY FORWARD TO THE SAFETY OFF – READY TO FIRE POSITION UNTIL YOU ARE READY TO SHOOT.**

**THE ONLY TIME YOU CAN BE ABSOLUTELY CERTAIN THAT A GUN CANNOT FIRE IS WHEN THE ACTION IS OPEN AND IT IS COMPLETELY EMPTY OF AMMUNITION.**

**NEVER TOUCH THE TRIGGER ON A FIREARM UNTIL YOU ACTUALLY INTEND TO SHOOT.**

**NEVER POINT YOUR GUN AT ANYTHING YOU DO NOT INTEND TO SHOOT.**

**BE SURE TO WEAR ADEQUATE EYE AND HEARING PROTECTION (CONSULT MANUFACTURER FOR THEIR RECOMMENDATION) WHEN EVER YOU INTEND TO SHOOT. HEARING LOSS AS WELL AS IRREPARABLE EYE DAMAGE CAN OCCUR UNLESS YOUR EYES AND EARS ARE PROPERLY PROTECTED .**

**ALWAYS KEEP THE MUZZLE POINTED IN A SAFE DIRECTION.**

1. Keep your finger off the trigger and out of the trigger guard until you are ready to shoot.

2. Always look carefully around to be sure that no one will cross in front of you when you are ready to shoot.
3. Place the firearm to your shoulder and move the safety forward to the SAFETY OFF – READY TO FIRE position and take aim.
4. Place your finger in the trigger guard and when you are on target, squeeze the trigger slowly.

**NO ONE CAN CALL A BULLET BACK.**

5. Pull up and fully rearward on the bolt handle to open the bolt and extract the fired shell.
6. Moving the bolt handle forward will push the next shell from the magazine into the chamber.
7. Move the safety fully rearward to the FULL SAFE position, locking the bolt handle.

**IT IS A GOOD PRACTICE TO CHECK THE ACTION SCREWS BEFORE SHOOTING TO VERIFY THEY ARE SECURE AND AT THE END OF EACH SHOOTING SESSION.**

### **UNLOADING**

**KEEP YOUR FINGERS AWAY FROM THE TRIGGER.**

**KEEP THE MUZZLE POINTED IN A SAFE DIRECTION.**

1. Push the magazine release button rearward (see FIGURE 12) to remove the magazine.
2. **With the muzzle pointed in a safe direction**, your finger completely away from the trigger and out of the trigger guard, move the safety forward to the SAFETY OFF – READY TO FIRE position.

KEEP YOUR FINGERS AWAY FROM THE TRIGGER.

3. Placing one hand over the ejection port, your finger completely away from the trigger and out of the trigger guard, lift the bolt handle and slowly pull to the rear to extract the shell from the chamber.

**LOOK AND FEEL! BE SURE THE CHAMBER AND MAGAZINE ARE COMPLETELY EMPTY -- DO NOT ASSUME!**

**A LOADED GUN HAS NO PLACE IN OR NEAR A VEHICLE OR BUILDING.**

## SECTION 6 – ACCUTRIGGER ADJUSTMENTS

### ACCUTRIGGER Pull Adjustment

**SAFE OWNERSHIP IS YOUR RESPONSIBILITY. PRIOR TO ADJUSTING THE ACCUTRIGGER PLEASE THOROUGHLY READ AND UNDERSTAND THE INSTRUCTION MANUAL IN ITS ENTIRETY.**

**MAKE SURE THE FIREARM IS UNLOADED AND THE BOLT IS OPEN BEFORE REMOVING THE STOCK AND ADJUSTING THE ACCUTRIGGER.**

### ADJUSTING THE ACCUTRIGGER

1. Remove the stock (see applicable section above).
2. Insert the ACCUTRIGGER supplied tool into the bottom of the trigger return spring as shown, to engage the spring-tail with the slot on the tool. Turn the trigger return spring (A) with the trigger adjustment tool (B) as shown in FIGURE 15 and FIGURE 16.
3. To adjust towards the higher range of pull, turn the tool clockwise. The maximum trigger pull is at the point where the spring “clicks” when rotated (see FIGURE 15).
4. To adjust towards the lower range of pull, turn the tool counter-clockwise. The minimum trigger pull is at the point where the large coil contacts the top surface of the trigger and you detect resistance (see FIGURE 16).

**THE SPRING SHOULD NOT BE FORCED BEYOND THESE LIMITS.**

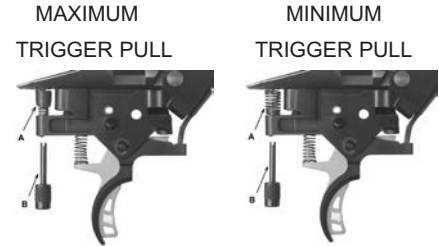

FIGURE 15

FIGURE 16

5. The **ACCURELEASE** (see FIGURE 17 and FIGURE 18) adds an additional level of safety by stopping the sear if the rifle is accidentally jarred or dropped with the safety in the “FIRE” position.

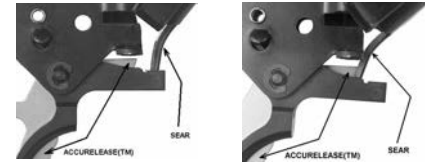

FIGURE 17

FIGURE 18

**EXCESSIVE JARRING OR PULLING THE TRIGGER WITHOUT DEPRESSING THE ACCURELEASE MAY CAUSE THE SEAR TO**

MOVE (SEE FIGURE 18). AS DESIGNED, THE ACCURELEASE WILL PREVENT ACCIDENTAL DISCHARGE BY 'LOCKING' THE TRIGGER **WHEN USED PROPERLY, MAINTAINED AND SERVICED REGULARLY.** IN THIS EVENT, THE BOLT MUST BE RE-COCKED IN ORDER TO RESET THE SEAR.

WHEN THE SEAR IS BLOCKED BY THE ACCURELEASE (SEE FIGURE 18), THE FIRING PIN IS RESTRAINED WITHIN THE BOLT ASSEMBLY, PREVENTING IT FROM HITTING THE PRIMER. THE 'CLICK' THAT IS HEARD IS THE ACTUAL SEAR BEING BLOCKED BY THE ACCURELEASE, NOT THE FIRING PIN!

## SECTION 7 – PARTS LIST AND DIAGRAM

FOR MORE INFORMATION, PLEASE VISIT OUR WEB SITE AT: [WWW.SAVAGEARMS.COM](http://WWW.SAVAGEARMS.COM)

As a 'customer driven' company, some parts may now be ordered directly from our web site ([WWW.SAVAGEARMS.COM](http://WWW.SAVAGEARMS.COM)) twenty four hours a day, needing only your serial number and credit card. For accessing our part finder via your Smartphone, please use the QR Code below. Should you not have access to our web site, parts can be ordered directly from Savage Arms [413-568-7001] between the hours of 9:00 and 4:00 (Eastern Time). There is a minimum order and please allow 2 weeks for delivery. Only the parts indicated may be purchased by an individual. All other parts/subassemblies are either 'factory fit' or available to qualified gunsmiths only.

Please be advised that some parts may require fitting. Savage Arms bears no responsibility for the function or performance of any firearm that has been repaired or modified by other than Savage Arms Service Department. As such, Savage Arms accepts no responsibility/liability for any direct and/or consequential damage and/or injury resulting from the use of a firearm repaired or modified by other than the Savage Arms Service Department.

*QR Code for your Smartphone for purchasing parts directly from our website - no calls - no waiting - 24 hours a day.*





MODEL 212

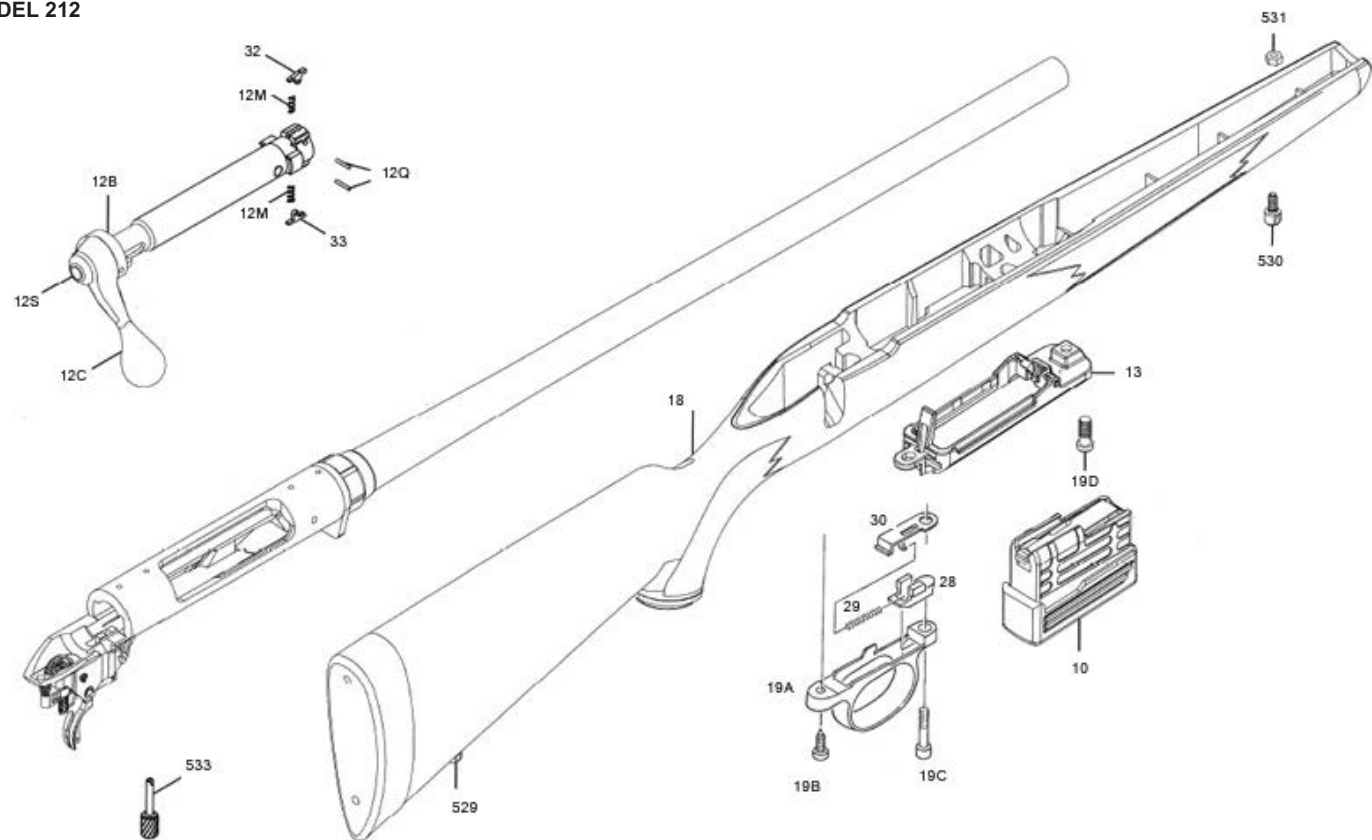

**MODEL 212**

<u>Item #</u>	<u>Description</u>
10	Detachable box magazine
12B	Rear baffle assembly
12C	Bolt handle
12M	Extractor spring
12Q	Retaining pin
12S	Bolt assembly screw
13	Frame assembly

<u>Item #</u>	<u>Description</u>
18	Stock assembly
19A	Trigger guard
19B	Rear trigger guard screw
19C	Rear action screw
19D	Front action screw
28	Bolt release button
29	Button spring

<u>Item #</u>	<u>Description</u>
30	Button retainer
32	Left hand extractor
33	Right hand extractor
529	Swivel stud
530	Swivel stud
531	10-32 Lock nut
533	Tension adjustment tool



**MODEL 220**

<u>Item #</u>	<u>Description</u>
10	Detachable box magazine
12B	Rear baffle assembly
12C	Bolt handle
12M	Extractor spring
12Q	Retaining pin
12S	Bolt assembly screw

<u>Item #</u>	<u>Description</u>
13	Frame assembly
18	Stock assembly
19A	Trigger guard
19B	Rear trigger guard screw
19C	Rear action screw
19D	Front action screw

<u>Item #</u>	<u>Description</u>
32	Left hand extractor
33	Right hand extractor
529	Swivel stud
530	Swivel stud
531	10-32 Lock nut
533	Tension adjustment tool

## SECTION 8 – AMMUNITION BULLET WEIGHTS AND MAGAZINE CAPACITIES

FOR MORE INFORMATION, PLEASE VISIT OUR WEB SITE AT: [WWW.SAVAGEARMS.COM](http://WWW.SAVAGEARMS.COM)

Bullet specifications and trajectories are available directly from the ammunition manufacturer.

The following table lists the bullet weights used for 100 yard targeting evaluation at Savage Arms. Performance may vary based on brand/type of ammunition, individual characteristics of the firearm, and/or shooting conditions.

**USE ONLY THE CORRECT AMMUNITION THAT IS STAMPED ON THE SIDE OF THE BARREL.**

**THE USE OF RELOADS, HANDLOADS, MILITARY SURPLUS, OR ANY OTHER COMMERCIAL / NONCOMMERCIAL AMMUNITION NOT MANUFACTURED TO SAAMI (SPORTING ARMS AND AMMUNITION MANUFACTURERS' INSTITUTE, INC.)/ ANSI (AMERICAN NATIONAL STANDARDS INSTITUTE) SPECIFICATIONS WILL VOID THE WARRANTY.**

Caliber	Recommended Ammunition
12 Gauge (Model 212)	Remington 3" 385 grain AccuTip
20 Gauge (Model 220)	Remington 3" 260 grain AccuTip

Caliber	Magazine Capacity
12 Gauge (Model 212)	2
20 Gauge (Model 220)	2

## SECTION 9 – RINGS AND BASES FOR MOUNTING A SCOPE

FOR MORE INFORMATION, PLEASE VISIT OUR WEB SITE AT: [WWW.SAVAGEARMS.COM](http://WWW.SAVAGEARMS.COM)

### **BASES:**

Model 212 is supplied with specially designed scope bases which fit the outer diameter of the receiver. Before using other scope bases, verify with the manufacturer that they have been designed to fit the new profile of the Model 212 receiver.

Model 220 is not supplied with bases and can be fitted with any WEAVER style base designed for a standard Savage bolt action centerfire firearm.

### **RINGS:**

The following companies manufacture RINGS that may be used with this style base or their own design.

The manufacturers listed below should be contacted for specific part numbers and information.

**B-SQUARE**  
13386 International Pkwy  
Jacksonville, FL 32218  
[www.b-square.com](http://www.b-square.com)

**EVOLUTION GUN WORKS (EGW)**  
48 Belmont Avenue  
Quakertown, PA 18951  
[www.egwguns.com](http://www.egwguns.com)

**BURRIS**  
920 54th Avenue  
Greeley, CO 80634  
[www.burrisoptics.com](http://www.burrisoptics.com)

**KWIK-SITE**  
5555 Treadwell  
Wayne, MI 48184  
[www.kwiksitecorp.com](http://www.kwiksitecorp.com)

**LEATHERWOOD /HI-LUX OPTICS**  
3135 Kashiwa Street  
Torrance, CA 90505  
[www.leatherwoodoptics.com](http://www.leatherwoodoptics.com)

**MILLETT**  
9200 Cody  
Overland Park, KS 66214  
[www.milletsights.com](http://www.milletsights.com)

**WEAVER MOUNTS**  
N5549 County Trunk Z  
Onalaska, WI 54650  
[www.weaver-mounts.com](http://www.weaver-mounts.com)

**LEUPOLD**  
14400 NW Greenbrier Pkwy  
Beaverton, OR 97006  
[www.leupold.com](http://www.leupold.com)

**WARNE SCOPE MOUNTS**  
9500 SW Tualatin  
Tualatin, OR 97062  
[www.warnescopemounts.com](http://www.warnescopemounts.com)

## SECTION 10 – MAINTENANCE

### ROUTINE MAINTENANCE

***YOUR GUN IS A MECHANICAL DEVICE WHICH WILL NOT LAST FOREVER AND IS SUBJECT TO WEAR. AS WITH ANY PRECISION TUNED MECHANICAL DEVICE, PERIODIC INSPECTION/ MAINTENANCE IS REQUIRED – AND YOUR RESPONSIBILITY!***

1. TIMEFRAMES: It is difficult to establish a time period or number of rounds as the basis for when a firearm should be examined, cleaned, and thoroughly inspected. Different shooting conditions, weather patterns, and types of ammunition, to list a few, all play a significant role in answering the questions 'when' and 'how often'. As a general rule, 'more often' is much safer than 'not enough'.

- As a start, the THREE POSITION SAFETY should be checked prior to loading live ammunition. This is an important step that should be done **every time** the firearm is prepared for use.
- Remove the bolt, look down the barrel to be sure it is clear of any obstruction and that there are no signs of damage (nicks, scratches, etc.), rust, or pitting.
- Check the outer surface of the barrel, running your fingers gently down its length, feeling for any bulges or signs of damage.
- While the bolt is out, inspect the bolt head, extractor, and ejector for signs of damage or signs of excessive wear.

- With the stock removed, carefully inspect the AccuTrigger and adjustment spring for damage or foreign debris (twigs, grass, etc.) (see FIGURE 15).
  - Carefully examine the stock and studs that secure the carrying strap.
  - Check the scope rings to be sure they have not loosened.
  - After the stock has been put back on, verify the action screws are tight.
2. WHO SHOULD DO THE CHECKING: As the owner – or user – it is your primary responsibility to assure the firearm is safe prior to using it. Although we know its condition when it leaves the factory, we have no control or insight as to what has or has not been done once it leaves our hands.

After reading and understanding this INSTRUCTION MANUAL – and **prior to** loading with live ammunition - you should be very familiar and capable of handling the items noted above. In depth mechanical issues or questions as well as periodic examinations should be referred to a qualified gunsmith or Savage Arms Service Department. Mechanical devices will by the nature of their design, wear and as such may require very specific adjustments. In the wrong hands, a 'simple' adjustment could result in serious damage to the firearm or even worse, injury or death to the shooter or bystander.

***KNOW YOUR GUN! IF ANYTHING 'FEELS' OR SOUNDS DIFFERENT - STOP - AND HAVE A QUALIFIED GUNSMITH TAKE A LOOK!***

***NEVER TAKE A CHANCE WITH SOMETHING THAT YOU ARE UNSURE OF ... ALWAYS ASK A PROFESSIONAL.***

### CLEANING AND CARE OF YOUR FIREARM

***BOLT ASSEMBLIES ARE SPECIFICALLY MATCHED TO A FIREARM. USING ANY OTHER BOLT ASSEMBLY MAY CAUSE EXTENSIVE DAMAGE TO THE FIREARM AND/OR SERIOUS INJURY TO THE SHOOTER OR BYSTANDER.***

***DISASSEMBLE ONLY ONE FIREARM AT A TIME TO AVOID INTERCHANGING COMPONENTS.***

***LOOK AND FEEL! BE SURE THE CHAMBER AND MAGAZINE ARE COMPLETELY EMPTY -- DO NOT ASSUME!!!***

***NEVER ATTEMPT TO DISASSEMBLE, CLEAN, OR OIL A LOADED FIREARM!***

***BE SURE TO READ AND UNDERSTAND ALL OF THE CAUTIONS AND WARNINGS ON ALL SOLVENTS AND CHEMICALS PRIOR TO USE. FOLLOW THE MANUFACTURER'S INSTRUCTIONS FOR BEST CLEANING RESULTS.***

1. Prepare an area for cleaning the firearm with a suitable surface, adequate ventilation, correct caliber cleaning rod, brush, patches, powder solvent and oil.
2. Remove the bolt.
3. Lay the firearm horizontally with the ejection port facing down.

**ALWAYS STARTING FROM THE CHAMBER END, PUSH THE CLEANING ROD THROUGH THE BORE AND OUT THE MUZZLE END.**

4. Using a small amount of powder solvent on the brush, push the cleaning rod through the barrel several times.
5. Unscrew the brush from the cleaning rod and replace it with a patch tip.
6. Push a new patch through the bore starting from the chamber end and out the muzzle.
7. Repeat the prior step (# 6) several times.
8. Push a new patch saturated with gun oil through the bore.
9. Push a new dry patch through the bore to remove the excess oil.
10. When done, always verify that the “THREE POSITION SAFETY” is operational as explained in the beginning of SECTION 2.

**CHECK THE BORE CAREFULLY WHEN DONE TO BE SURE THERE ARE NO OBSTRUCTIONS (I.E. PIECES OF CLEANING PATCH, ETC.).**

**A VERY THIN FILM OF OIL IS SUFFICIENT PROTECTION – DO NOT OVER OIL!!!**

**FAILURE TO PROPERLY MAINTAIN YOUR FIREARM MAY LEAD TO DAMAGE AND/OR SERIOUS INJURY TO THE SHOOTER OR BYSTANDER.**

**PROTECTING METAL SURFACES**

1. In order to be able to reach all surfaces, remove the bolt prior to cleaning and oiling.
2. With a soft cloth, remove any foreign matter (i.e. mud, twigs, grass).
3. Apply a thin coat of gun oil on all cleaned metal surfaces. Rubbing may be necessary to remove any signs of rust.
4. Where accessible, clean and lightly oil interior metal surfaces.
5. When done, always verify that the “THREE POSITION SAFETY” is operational as explained in the beginning of SECTION 2.

***DO NOT DISASSEMBLE THE BOLT ASSEMBLY.***

***CHECK THE BORE CAREFULLY WHEN DONE TO BE SURE THERE ARE NO OBSTRUCTIONS (I.E. PIECES OF CLEANING PATCH, ETC.).***

**SECTION 11 – STATEMENT OF LIMITED WARRANTY**

FOR MORE INFORMATION, PLEASE VISIT OUR WEB SITE AT: [WWW.SAVAGEARMS.COM](http://WWW.SAVAGEARMS.COM)

**STATEMENT OF LIMITED WARRANTY**

For your convenience, registration may now be completed directly from our web site (WWW.SAVAGEARMS.COM) twenty four hours a day (QR CODE provided for your Smartphone next to the warranty card). Should you not have access to our web site, please complete the WARRANTY REGISTRATION CARD and return it to Savage Arms, Inc. within ten (10) days from the date of purchase.

**WHO IS COVERED?**

- The original owner (with proof of purchase).

**WHAT IS COVERED?**

- Any defect in materials or workmanship (performed by Savage Arms) encountered during normal use.

**HOW LONG IS THE WARRANTY PERIOD?**

- One (1) year from the date of purchase.

**WHAT IS NOT COVERED?**

**PERSONAL INJURY, PROPERTY DAMAGE, AND/OR DAMAGE TO THE FIREARM CAUSED BY:**

- Improper maintenance or negligence to provide proper care and maintenance.
- Alterations/modifications performed without the written authorization of Savage Arms,

- Inc. Service Department.
- Normal wear; tear; and/or corrosion.
  - Accidental discharge, careless handling, and/or misuse.
  - Barrel obstructions.

#### **EXCLUSIONS AND LIMITATIONS:**

This *WARRANTY* and the remedies set forth herein are exclusive and take the place of all other expressed or implied *WARRANTIES* (including any implied *WARRANTY* of merchantability or fitness for any particular purpose which are disclaimed). No other representations or claims of any nature shall be binding on or obligate Savage Arms, Inc.

Savage Arms, Inc. excludes any incidental and consequential damages under this warranty. Some states do not allow exclusions or limitations on how long an implied warranty lasts, so the above limitations may not apply to you.

This *WARRANTY* gives you specific legal rights. You may have other rights, which will vary from state to state.

#### **RETURNING A FIREARM:**

For *WARRANTY* claims, proof of purchase must accompany the firearm.

It is a violation of Federal Law to ship a firearm with live ammunition either in the detachable box magazine, chamber, or placed in the box. For the safety of all involved PLEASE be sure there is no ammunition in either the chamber, detachable box magazine, or box.

Savage Arms, Inc. is not responsible for the loss or damage to any accessories shipped with the firearm.

If there is a question whether the firearm should be returned or parts could be purchased, please call 1-413-568-7001 between 9:00 am and 4:00 p.m. Eastern Time and ask for the Service/Warranty Department.

All firearms are to be sent to Savage Arms, Inc. at the owner's expense. Warranty repairs will be returned to the owner at Savage Arms' expense.

1. Pack the firearm in its original box if possible. If a similar suitable box is used, care should be taken to protect the barrel/muzzle from breaking through. Always pack with the assumption that the firearm will undergo rough handling during transit to Savage Arms.
2. Enclose a brief note including:
  - name, address and phone number of the sender
  - serial number of the firearm
  - description of the problem you are having
  - bullet weight, bullet type, and manufacturer of the ammunition you are using
  - any other information which you feel may be helpful.

3. Return to:

Savage Arms, Inc.  
100 Springdale Road  
Westfield, MA 01085  
Attn: Service Department

4. If there will be a charge involved for the repair, a quote will be sent within fourteen (14) working days.

- If there is no response from the quote within thirty (30) days, the firearm will be returned COD (\$20.00 Shipping/Handling).

Firearms will be repaired typically 3 weeks after receipt of payment in the order they were received.





For more than a century, Savage Arms has carefully crafted the world's most accurate, consistent and reliable firearms. We're proud to stand behind our products with a 1-year warranty, and we're willing to do whatever it takes to ensure your Savage performs as it should.

To take full advantage of this warranty, please register your firearm at [www.savagearms.com/warranty](http://www.savagearms.com/warranty).

For new product purchases, please complete the online warranty registration within 10 days from the date of purchase.

## Statement of Limited Warranty

### *Who is covered?*

The original owner (with proof of purchase).

### *How long is the warranty period?*

One (1) year from the date of purchase.

### *What is covered?*

Any defect in materials or workmanship (performed by Savage Arms) encountered during normal use.

### *What is NOT covered?*

Personal injury, property damage, and/or damage to the firearm caused by:

- Improper maintenance or negligence to provide proper care and maintenance.
- Alterations/modifications performed without the written authorization of the Savage Arms Service Department.
- Normal wear, tear and/or corrosion.
- Accidental discharge, careless handling and/or misuse.
- Barrel obstructions.

## Exclusions and Limitations

This warranty and the remedies set forth herein are exclusive and take the place of all other expressed or implied WARRANTIES (including any implied warranty of merchantability or fitness for any particular purpose which are disclaimed). No other representations or claims of any nature shall be binding on or obligate Savage Arms. Savage Arms excludes any incidental and consequential damages under this warranty. Some states do not allow exclusions or limitations on how long an implied warranty lasts, so the above limitations may not apply to you.

This warranty gives you specific legal rights. You may have other rights, which will vary from state to state.



**You're proud to  
shoot a Savage—  
so show it!**

Choose from a wide selection of Savage t-shirts, hats and other great apparel and gear at [store.savagearms.com](http://store.savagearms.com).

Don't miss out—check back often for the latest designs.

Receive **10% OFF**  
your first order!

Code will be emailed to you after you complete your online warranty registration.

[www.store.savagearms.com](http://www.store.savagearms.com)



## WARNING

Firearms must be handled responsibly and securely stored to prevent access by children and other unauthorized users. California has strict laws pertaining to firearms, and you may be fined or imprisoned if you fail to comply with them. Visit the Web site of the California Attorney General at <https://oag.ca.gov/firearms> for information on firearm laws applicable to you and how you can comply. Prevent child access by always keeping guns locked away and unloaded when not in use. If you keep a loaded firearm where a child obtains and improperly uses it, you may be fined or sent to prison.



## ADVERTENCIA

Las armas de fuego requieren de manejo responsable y almacenamiento seguro para evitar que niños u otros usuarios no autorizados tengan acceso a estas. California cuenta con leyes estrictas sobre las armas de fuego, y usted puede ser multado o sentenciado a prisión si no las cumple. Visite la página web del fiscal general de California en <https://oag.ca.gov/firearms> para obtener más información sobre las leyes de armas de fuego que apliquen y cómo cumplirlas. Evite que los niños tengan acceso a las armas, manteniéndolas guardadas bajo llave y descargadas siempre que no estén en uso. Si mantiene un arma cargada en un lugar donde un niño tiene acceso a ella y la utiliza de forma indebida, puede ser multado y enviado a prisión.



## AVERTISSEMENT

Les armes à feu doivent être manipulées de manière responsable et entreposées de façon sécuritaire, hors de la portée des enfants et d'autres personnes non autorisées. Les lois californiennes relatives aux armes à feu sont strictes, et le non-respect de ces lois peut entraîner une amende ou une peine d'emprisonnement. Consultez le site Web du Procureur général de Californie au <https://oag.ca.gov/firearms> pour de l'information sur les lois touchant les armes à feu applicables et sur les moyens de s'y conformer. Pour empêcher les enfants d'accéder aux armes à feu, celles-ci doivent toujours être enfermées dans un lieu sûr et déchargées, lorsqu'elles ne sont pas utilisées. Toute personne qui entrepose une arme à feu chargée à un endroit où un enfant peut l'obtenir et en faire une mauvaise utilisation est passible d'une amende ou d'emprisonnement.



## WARNING

This product can expose you to chemicals including lead, which is known to the State of California to cause cancer and reproductive harm. For more information go to [www.P65Warnings.ca.gov](http://www.P65Warnings.ca.gov)



## ADVERTENCIA

Este producto puede exponerle a sustancias químicas que incluyen el plomo, que el estado de California reconoce como causante de cáncer y daños al sistema reproductivo. Para más información, visite [www.P65Warnings.ca.gov](http://www.P65Warnings.ca.gov)



## AVERTISSEMENT

Ce produit peut exposer l'utilisateur à des produits chimiques, comme le plomb, que l'État de Californie reconnaît comme étant cancérigène et nocif pour la reproduction. Pour plus d'information, consultez le [www.P65Warnings.ca.gov](http://www.P65Warnings.ca.gov)

 **SAVAGE ARMS®**

100 Springdale Road  
Westfield, MA 01085

[www.savagearms.com](http://www.savagearms.com)