

⚠ WARNING:

BEFORE USING THIS FIREARM, READ AND FOLLOW THESE INSTRUCTIONS
If there is anything you do not understand, get help from someone qualified in
the safe handling of firearms.

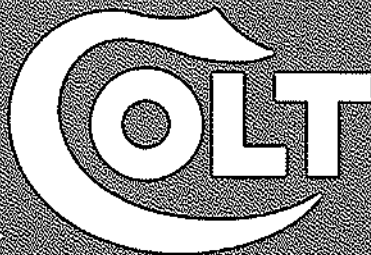

®

**SAFETY
AND
INSTRUCTION
MANUAL**

**SINGLE ACTION ARMY REVOLVER
SHERIFF'S AND STOREKEEPER'S
MODEL REVOLVERS
NEW FRONTIER® SINGLE ACTION
ARMY REVOLVER**

Copyright © 1993 Colt's Manufacturing Company, Inc. All Rights Reserved.
This instruction manual should always accompany this firearm.
When you lend, give or sell this firearm, be sure this manual goes with it.

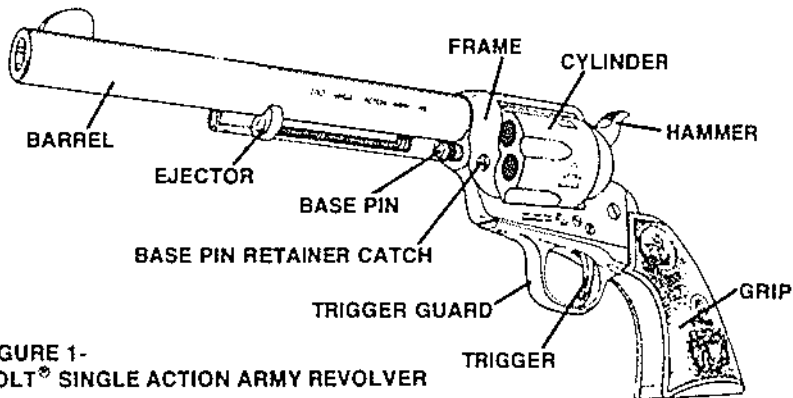

**FIGURE 1-
COLT® SINGLE ACTION ARMY REVOLVER**

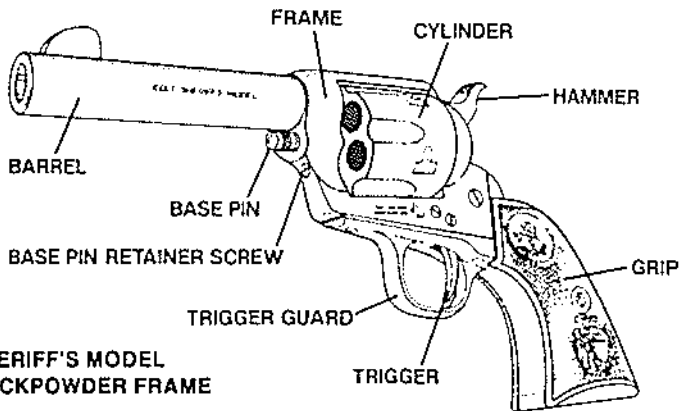

**FIGURE 2-
COLT® SHERIFF'S MODEL
WITH BLACKPOWDER FRAME**

SAFETY DEPENDS ON YOU

THIS IS A COLLECTOR'S FIREARM



WARNING: THIS REVOLVER HAS BEEN RECREATED FROM A HISTORIC DESIGN AND IS EXTREMELY DANGEROUS TO HANDLE WHEN LOADED.

Collectors of fine firearms, such as this Colt revolver, should be aware that:

1. Loading and unloading the firearm will show wear and lead to loss of collector value.
2. Excessive handling will lead to premature wear and cause loss of value.
3. Firing this revolver will cause immediate extreme loss of collector's value.



CAUTION: IF YOU HAVE READ THE WARNING ABOVE, AND ACCEPT THE LOSS OF COLLECTOR'S VALUE AND THE RISK OF DANGER FROM LOADING THIS REVOLVER USE THE INFORMATION IN THE REST OF THIS MANUAL TO MINIMIZE THE RISK OF INJURY, DEATH OR DAMAGE TO PROPERTY.

READ AND UNDERSTAND ALL THE FOLLOWING PRECAUTIONS BEFORE REMOVING THIS FIREARM FROM ITS PACKAGE.

This Colt product is classified by the Alcohol, Tobacco and Firearms Division of the Internal Revenue Service, U.S. Treasury Department, as a firearm or dangerous weapon; it is, therefore, potentially lethal!

 **WARNING: IF THIS FIREARM IS CARELESSLY OR IMPROPERLY HANDLED, UNINTENTIONAL DISCHARGE COULD RESULT AND COULD CAUSE INJURY, DEATH, OR DAMAGE TO PROPERTY.**

 **CAUTION: CAREFULLY READ THIS INSTRUCTION MANUAL WHICH GIVES BASIC ADVICE ON THE PROPER HANDLING AND FUNCTIONING OF THIS COLT FIREARM PRIOR TO LOADING AND FIRING. However, your safety and the safety of others (including your family) depends on your mature compliance with that advice, and your adoption, development and constant employment of safe practices.**

If unfamiliar with firearms, seek further advice through safe handling courses run by your local gun clubs, NRA approved instructor, or similar qualified organizations.

NOTICE

Colt shall not be responsible for injury, death, or damage to property resulting from either intentional or accidental discharge of this firearm, or from its function when used for purposes or subjected to treatment for which it was not designed. Colt will not honor claims involving this firearm which result from careless or improper handling, unauthorized adjustment or parts replacement, corrosion, neglect, or the use of wrong caliber ammunition, or the use of ammunition other than original high quality commercially manufactured ammunition in good condition, or any combination thereof. Colt will not honor claims involving this firearm for any reason or cause when such claims are made by the second or subsequent owner.

IMPORTANT

Before it left the factory this firearm was tested, carefully inspected, and packaged. Colt cannot control product handling after it leaves the factory; therefore, please examine this firearm carefully at the time of purchase to insure that it is unloaded and undamaged. The dealer will be pleased to assist you in making this examination and endeavor to answer your further questions.

This instruction manual should always accompany this firearm and be transferred with it upon change of ownership.

IMPORTANT: Before going further be sure you have read and fully understand the message on page 1.



CAUTION: IF YOU DECIDE TO FIRE THIS COLLECTOR'S REVOLVER, USE ONLY ORIGINAL HIGH QUALITY COMMERCIALY MANUFACTURED AMMUNITION IN GOOD CONDITION WHICH IS APPROPRIATE TO THE CALIBER OF YOUR REVOLVER — SEE TABLE BELOW.

Revolver Chamber Size	Suitable Ammunition								
	44 Spec.	44-40	45 Colt	45 ACP	357 Mag.	38 Spec.	38 Spec. +P	9mm	38-40
44 Special	Yes	No	No	No	No	No	No	No	No
44-40	No	Yes	No	No	No	No	No	No	No
45 Colt	No	No	Yes	No	No	No	No	No	No
45 ACP	No	No	No	Yes	No	No	No	No	No
357 Mag	No	No	No	No	Yes	Yes	Yes	No	No
9mm	No	No	No	No	No	No	No	Yes	No
38-40	No	No	No	No	No	No	No	No	Yes

LIST OF SECTIONS

SECTION	TITLE	PAGE
1	PRECAUTIONS	2
2	Main Features	6
3	Safety Instructions:	7
	Cautions	8
	Safety Features:	15
	Hammer Safety Position	15
	Half-Cock Position (for loading)	17
4	Function:	20
	Loading	20
	Carrying Modes	23
	Unloading	24
	To Unload Revolvers with ejector rods	24
	To Unload Revolvers without ejector rods	26
	Firing and Sight Adjustments	27
5	Maintenance:	32
	Stripping for Cleaning	32
	Assembling after Cleaning	33
	When to Clean	33
	How to Clean	34
	Storage	36
	Servicing and Repair	36
6	Parts Illustration and List	39
7	The Customized Gun	42

SAFETY DEPENDS ON YOU

The Colt Single Action Army (SAA) revolver, like the 1873 original, is built the Colt way. The New Frontier Single Action Army (NFSAA) and some Sheriff's Model revolvers are functionally identical to the Single Action Army except that the NFSAA has a ramp style front sight and adjustable rear sight, while the Sheriff's Model has no ejector rod and special issues have dual cylinders. Some other Sheriff's Models and the Storekeeper's Model have Blackpowder frames with no ejector rod and a screw instead of a spring loaded catch to retain the basepin. This instruction manual applies to these revolvers, commemorative issues of these revolvers and to the variations of them shown in the table below.

Revolver Type	Barrel Lengths	Finishes	Sights
Single Action Army Revolver, 45 Colt, 357 Magnum, 44 Special, 44-40, 45 ACP, 9mm or 38-40	4¾", 5½" 7½" or 12"	Colt Blue (color case hardened frame) or Nickel.	Fixed rear square notch. Fixed front blade.
New Frontier Single Action Army Revolver, 45 Colt, 357 Magnum, 44 Special, or 44-40	4¾", 5½" or 7½"	Royal Blue (color case hardened frame) or Nickel.	Fully adjustable rear. Ramp-style front
Storekeeper's and Sheriff's Models, 44 Special or 44-40	3" or 4"	Colt or Royal Blue (color case hardened frame) or Nickel with some Royal Blue parts	Fixed rear square notch. Fixed front blade.

If you have read the warning on page 1 and accept the loss of value and the risk of danger from loading this revolver then follow these safety instructions to reduce the risk of accidental discharge resulting in injury, death or damage to property. You may be an experienced safe shooter already familiar with the procedures in this instruction manual, or you may never have handled a gun before but if you decide to load live ammunition into this revolver we urge you to read this entire instruction manual carefully. You must follow the safety instructions for your safety and the safety of others.

 **WARNING: DO NOT CARRY THIS FIREARM WITH A LOADED CHAMBER IN FRONT OF THE HAMMER. THIS WILL MINIMIZE THE RISK OF AN ACCIDENTAL DISCHARGE.**

 **WARNING: IF REVOLVER IS DROPPED ON HAMMER, IF REVOLVER IS FANNED, OR IF EXCESSIVE FORCE IS APPLIED TO THE TRIGGER—"SAFETY" AND "HALF-COCK" NOTCHES COULD BREAK, CAUSING ACCIDENTAL DISCHARGE WHICH COULD RESULT IN INJURY, DEATH, OR DAMAGE TO PROPERTY. (Note: Normal trigger pull is 5 lbs. maximum—excessive force is 35 lbs. or more.)**

 **WARNING: When you squeeze the trigger, you must expect the gun to fire, and you must take full responsibility for firing it. Your care can avoid accidental discharge, and you will thereby avoid accidental injury and death.**

CAUTIONS:



GENERAL HANDLING CAUTIONS

- 1. ALWAYS HANDLE YOUR REVOLVER AS IF IT WERE LOADED** so that you never fire it accidentally when you think it is unloaded.
- 2. NEVER POINT YOUR REVOLVER AT ANYTHING YOU DO NOT INTEND TO SHOOT** so that if it fires accidentally, injury, death, or damage to property will be prevented.
- 3. NEVER TAKE ANYONE'S WORD THAT A GUN IS UNLOADED;** check for yourself with fingers off the trigger and gun pointed in a safe direction, so that you never fire the gun accidentally when you think it is unloaded.
- 4. ALWAYS KEEP AND CARRY YOUR REVOLVER EMPTY, WITH THE HAMMER IN THE SAFETY POSITION,** except when you intend to shoot, so that your revolver cannot be fired when you do not mean to fire it.
- 5. ALWAYS MAKE SURE YOUR REVOLVER IS NOT LOADED, THE HAMMER IS AT HALF COCK AND LOADING GATE IS OPEN BEFORE LAYING IT DOWN, OR HANDING IT TO ANOTHER PERSON,** so that it cannot be fired when it is unsafe to do so.
- 6. NEVER LEAVE REVOLVER COCKED READY TO FIRE.** This condition is extremely dangerous, and revolver could easily be accidentally discharged, causing injury, death, or damage

to property.

7. NEVER LEAVE A LOADED REVOLVER UNATTENDED. Someone, especially a child, may fire it and cause injury, death, or damage to property.

8. ALWAYS INSTRUCT CHILDREN TO RESPECT FIREARMS. If you teach your children to shoot, teach them to treat and use the revolver properly, and always supervise them closely. Always stress safety so that your children will not fire the revolver when it is unsafe to do so.



RANGE CAUTIONS

9. ALWAYS BE SURE YOUR BACKSTOP IS ADEQUATE to stop and contain bullets before beginning target practice so that you do not hit anything outside the range shooting area. **THINK! *What will you HIT if you MISS the target?***

10. ALWAYS PUT A KNOWLEDGEABLE AND RESPONSIBLE PERSON IN CHARGE TO MAINTAIN SAFETY CONTROL WHEN A GROUP IS FIRING ON A RANGE. Obey his commands so that discipline is maintained to reduce the likelihood of accidents.

11. ALWAYS CARRY YOUR REVOLVER EMPTY WITH THE LOADING GATE OPEN WHILE ON A RANGE until preparing to fire. Keep it pointing towards the backstop when loading, firing and unloading, to eliminate the risk of injury, death, or damage to property.



LOADING/UNLOADING CAUTIONS

12. ALWAYS BE SURE BARREL BORE AND CYLINDER CHAMBERS ARE CLEAR OF OBSTRUCTIONS. Clean a fouled revolver immediately so that it will function correctly and safely.

13. ALWAYS USE ONLY CLEAN, DRY, ORIGINAL HIGH QUALITY COMMERCIALLY MANUFACTURED AMMUNITION IN GOOD CONDITION WHICH IS APPROPRIATE TO THE CALIBER OF YOUR REVOLVER. (See page 4.) Gun and ammunition manufacturers design their products within exacting engineering safety limits. Handloads are sometimes outside those limits and can be so unsafe as to blow up the cylinder and frame and cause injury, death, or damage to property.

14. ALWAYS EXERCISE EXTREME CARE TO KEEP MUZZLE POINTING IN A SAFE DIRECTION, WELL CLEAR OF YOUR BODY, PARTICULARLY WHEN UNLOADING REVOLVERS THAT DO NOT HAVE EJECTOR RODS.



SHOOTING CAUTIONS

15. NEVER DRINK ALCOHOLIC BEVERAGES OR TAKE DRUGS BEFORE OR DURING SHOOTING, as your vision and judgment could be seriously impaired making your gun handling unsafe.

16. ALWAYS SEEK A DOCTOR'S ADVICE IF YOU ARE TAK-

ING MEDICATION, to be sure you are fit to shoot and handle your revolver safely.

17. ALWAYS WEAR AND ENCOURAGE OTHERS TO WEAR EAR PROTECTION WHEN SHOOTING, especially on a range. Without ear protection, the noise from your revolver and other guns close to you, could leave a "ringing" in the ears for some time after firing, while the cumulative long term effect could be permanent hearing loss.

18. ALWAYS WEAR AND ENCOURAGE OTHERS TO WEAR PROTECTIVE SHOOTING GLASSES. Flying particles could damage eyes and cause blindness; but protective shooting glasses should prevent such injury.

19. ALWAYS KEEP AN EMPTY CHAMBER IN FRONT OF HAMMER WITH HAMMER IN SAFETY POSITION WHEN REVOLVER IS LOADED UNTIL YOU ARE READY TO FIRE. This will minimize risk of an accidental discharge.

20. ALWAYS HOLD REVOLVER BY THE GRIP AND KEEP BOTH HANDS WELL CLEAR OF, AND BEHIND THE CYLINDER. Never hold it near the cylinder as very hot gas and lead particles may be sprayed out around the cylinder . . . these would injure your hands.

21. NEVER SQUEEZE THE TRIGGER OR PUT YOUR FINGER IN THE TRIGGER GUARD UNTIL YOU ARE AIMING AT A TARGET AND READY TO SHOOT. This will prevent you firing the revolver when it is pointing in an unsafe direction.

22. ALWAYS BE ABSOLUTELY SURE OF YOUR TARGET AND THE AREA BEHIND IT BEFORE YOU SQUEEZE THE TRIGGER. A bullet could travel through or past your target up to 1½ miles . . . if in doubt, don't shoot. **THINK!** *What will you HIT if you MISS the target?*

23. NEVER SHOOT AT A HARD SURFACE SUCH AS ROCK, OR A LIQUID SURFACE SUCH AS WATER. A bullet may ricochet and travel in any direction to strike you, another person or an object you cannot see, causing injury, death, or damage to property.

24. NEVER DISCHARGE A FIREARM NEAR FLAMMABLE MATERIAL. Flame and sparks erupt from the firearm when discharged. They could start a fire or cause flammable liquids and gases to explode.

25. NEVER FIRE YOUR REVOLVER NEAR AN ANIMAL unless it is trained to accept the noise; an animal's startled reaction could injure it or cause an accident.

26. NEVER INDULGE IN "HORSEPLAY" WHILE HOLDING YOUR REVOLVER as it may be accidentally discharged.

27. NEVER WALK, CLIMB OR FOLLOW A COMPANION WITH YOUR REVOLVER COCKED READY TO FIRE, out of its holster, or with the hammer in any position other than in "safety" with an empty chamber in front of the hammer to minimize risk of an accidental discharge. When hunting, hold your revolver so that you can always control the direction of the muzzle.



UNLOADING CAUTION

28. ALWAYS EXERCISE EXTREME CARE TO KEEP MUZZLE POINTING IN A SAFE DIRECTION, WELL CLEAR OF YOUR BODY, particularly when unloading revolvers that do not have ejector rods.



MALFUNCTION CAUTIONS

29. FAILURE TO FIRE: ALWAYS HOLD REVOLVER, KEEPING IT POINTED TOWARDS THE TARGET OR A SAFE OPEN AREA AND WAIT 30 SECONDS when revolver fails to fire. If a hangfire (slow ignition) has occurred, round will fire within 30 seconds. If round does not fire, eject round and examine primer in base of misfired round. If firing pin indent on primer is light, misaligned or non-existent, have revolver examined by a competent gunsmith. If firing pin indent on primer appears normal (in comparison with similar previously fired rounds) assume faulty ammunition; segregate misfired round from other live ammunition and empty cases, reload and carry on firing.

NOTE: Dispose of misfired rounds in accordance with ammunition manufacturer's instructions.

30. NEVER USE YOUR REVOLVER IF IT FAILS TO FUNCTION PROPERLY, AND NEVER FORCE A JAMMED ACTION, as a round may explode causing serious injury, possible death, or severe damage to your revolver.



CLEANING AND STORAGE CAUTIONS

31. ALWAYS MAKE SURE YOUR REVOLVER IS NOT LOADED BEFORE CLEANING, STORING, TRAVELING, LAYING IT DOWN, OR HANDING IT TO ANOTHER PERSON, so that it cannot be fired when it is unsafe to do so.

32. ALWAYS KEEP AND STORE YOUR REVOLVER AND AMMUNITION IN SEPARATE LOCKED RECEPTACLES OUT OF REACH AND SIGHT OF CHILDREN AND UNTRAINED PEOPLE, to minimize the risk of revolver and ammunition being easily available for loading and firing.



GUN ABUSE CAUTIONS

33. NEVER "FAN" YOUR REVOLVER. YOU COULD BREAK THE FIRING MECHANISM AND MAKE REVOLVER UNSAFE. Your accuracy will be reduced and you may hit something other than target aimed at. Altering the single action mechanism for fanning would also make the revolver unsafe; do not make or attempt to make this alteration.

34. NEVER ABUSE YOUR REVOLVER by using it for any purpose other than collecting or shooting.

IMPORTANT: Do not dry fire your Colt Single Action Revolver as repeated dry firing could damage the firing pin. (Dry firing is snapping the hammer on an empty chamber.)

NOTE: Please note that we have chosen to use the word "SQUEEZE" in this instruction manual instead of "PULL" or

“PRESS” when trigger movement is described; this is simply to remind you of the need for a gentle squeezing action to achieve accuracy.

SAFETY FEATURES

The safety features on the Colt single action revolver, when properly employed, can minimize the risk of accidental discharge.

Trigger Guard

The Trigger Guard is a metal loop around the trigger to protect it from damage and to help prevent accidental discharge.

Hammer Positions

There are three distinct hammer positions on a Colt revolver; two, which are described below, are safety features, while the third, which will be described later, is the COCKED position for firing.

HAMMER SAFETY POSITION—With the hammer in the Safety position the sear end of the trigger engages the first notch (safety notch) of the hammer. See Figure 3. In this position, the firing pin does not protrude through the firing pin hole, so that it cannot contact ammunition in the cylinder chambers and the trigger cannot be moved unless enough force is applied to break it or the notch. (Note: Normal trigger pull is 5 lbs. maximum, while excessive force is 35 lbs. or more.)

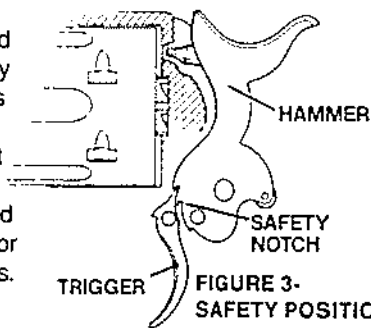

SAFETY DEPENDS ON YOU

⚠ CAUTION: ALWAYS CARRY YOUR SINGLE ACTION REVOLVER IN THIS "SAFETY" POSITION WITH AN EMPTY CHAMBER IN FRONT OF THE HAMMER.

To put the hammer in the safety position, place your thumb firmly on the hammer spur, (**DO NOT TOUCH THE TRIGGER**) and draw the hammer back about a quarter inch. When you hear a "click," gently ease hammer slightly forward, allowing safety notch to engage and hold hammer in safety position.

⚠ CAUTION: DO NOT ATTEMPT TO ENGAGE SAFETY NOTCH DIRECTLY FROM HALF-COCK OR COCKED POSITIONS unless you release the trigger completely before the hammer reaches the safety position, as the safety notch may not be engaged correctly.

..... SAFETY POSITION

_____ HALF-COCK POSITION

**FIGURE 4-
SAFETY AND HALF-COCK POSITIONS
—EXTERNAL**

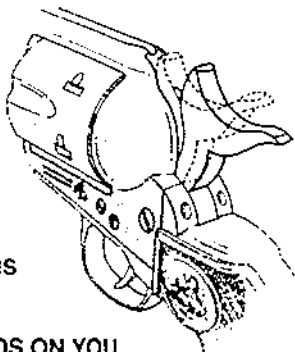

HALF-COCK (OR LOADING) POSITION—With the hammer in the Half-Cock position the sear end of the trigger engages the half cock notch and the cylinder is free to rotate for loading, unloading, inspection and further maintenance. See figure 4. Once in this position the trigger cannot be moved unless enough force is applied to break it or the notch.

CAUTION: NEVER CARRY YOUR REVOLVER IN THE HALF-COCK POSITION AS ACCIDENTAL DISCHARGE MAY BE POSSIBLE IF REVOLVER IS SUBSEQUENTLY DROPPED, MIS-HANDLED OR MISTREATED.

**FIGURE 5-
HALF-COCK POSITION**

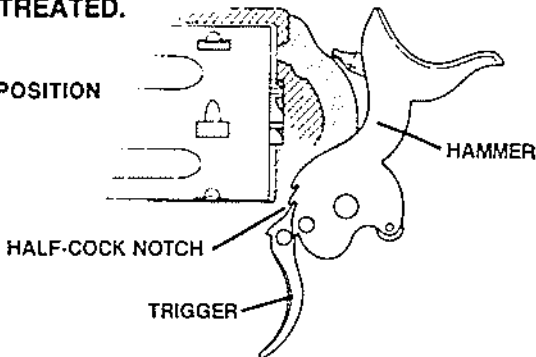

To place the hammer in Half-Cock position (DO NOT TOUCH THE TRIGGER) put thumb firmly on the hammer spur and draw hammer back about three quarters inch from Safety position. When you hear a "click" gently ease hammer slightly forward allowing Half-Cock notch to be engaged to hold hammer in Half-Cock position.

IMPORTANT: If you draw the hammer too far back another "click" will be heard. This "click" is caused by the bolt engaging the cylinder which will not be free to rotate when hammer is lowered into Half-Cock position. If you find the cylinder locked DO NOT FORCE IT. Simply return the hammer to the Safety position and draw it back again into the Half-Cock position as described in this manual.

The Safety and Half-Cock positions also serve to arrest the forward movement of the hammer and prevent a round being fired should your thumb accidentally slip from the hammer spur. This safety feature is effective provided YOU DO NOT TOUCH THE TRIGGER.

IMPORTANT: The Safety and Half-Cock notches in the mechanism are designed to prevent the trigger from being pulled, so DO NOT FORCE THE TRIGGER WITH HAMMER IN "SAFETY" or "HALF-COCK" POSITIONS. The mechanism could be damaged by such action, rendering the revolver unsafe.

When you no longer want the hammer at Half-Cock, place thumb firmly on hammer spur and draw hammer back slightly to disengage Half-Cock notch. Insure that empty chamber remains in front of hammer. Squeeze trigger only long enough to allow hammer to move forward and clear Half-Cock notch, then release trigger completely so that Safety notch can be properly engaged, and lower hammer, controlling its movement with your thumb, into the Safety position. Practice this action with an empty revolver to assure proper feel.

⚠ WARNING: IF YOU DO NOT RELEASE TRIGGER FULLY BEFORE REACHING SAFETY POSITION, SAFETY NOTCH MAY NOT BECOME FULLY AND SAFELY ENGAGED, RENDERING IT INEFFECTIVE AS A SAFETY DEVICE.

⚠ WARNING: IF REVOLVER IS DROPPED ON HAMMER, IF REVOLVER IS FANNED, OR IF EXCESSIVE FORCE IS APPLIED TO TRIGGER—"SAFETY" AND "HALF-COCK" NOTCHES COULD BREAK, CAUSING ACCIDENTAL DISCHARGE WHICH COULD RESULT IN INJURY, DEATH, OR DAMAGE TO PROPERTY. (Note: Normal trigger pull is 5 lbs. maximum—exclusive force is 35 lbs. or more.)

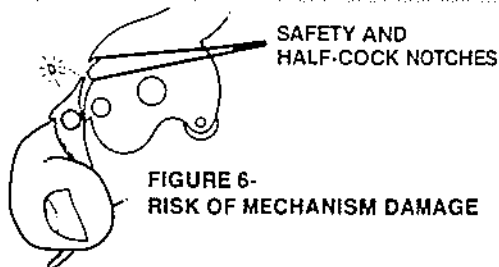



**FIGURE 6-
RISK OF MECHANISM DAMAGE**

IMPORTANT: If you suspect excessive force has been applied to the trigger (35 lbs. or more applied on a plane parallel to the barrel) or if revolver has been dropped or has otherwise received a sharp blow which may also damage or break the notches—have the revolver inspected for safe functioning by a competent gunsmith.

Your Colt Single Action revolver will be ready to fire when chambers in the cylinder are loaded with ammunition (see loading instructions), and hammer has been drawn all the way back past Safety and Half-Cock positions to the Cocked position. The Action of "cocking" lowers cylinder locking bolt, rotates cylinder to carry a round of ammunition into alignment with barrel and hammer, raises cylinder locking bolt to lock cylinder and holds hammer under spring tension. When trigger is squeezed, hammer falls forward causing firing pin to pass through the firing pin hole and strike primer of base of cartridge. The energy imparted to the primer ignites it, in turn igniting the main charge which, in burning, rapidly generates extremely high gas pressure to drive the bullet down the barrel. Rifling grooves in the barrel impart stabilizing spin to the bullet so that it will follow a more accurate path to the target.

LOADING

-  **CAUTION: TO MINIMIZE RISK OF UNINTENTIONAL DAMAGE, LOAD LIVE AMMUNITION INTO REVOLVER ONLY WHEN YOU ARE ABOUT TO SHOOT.**
-  **CAUTION: BEFORE LOADING STOREKEEPER'S OR SHERIFF'S MODEL MAKE SURE THAT AMMUNITION MATCHES THE CYLINDER INSTALLED and never load a cylinder unless it is installed in the revolver frame.**

To Load:

1. CAUTION: READ SAFETY INSTRUCTIONS (section 3)—KEEP REVOLVER POINTING IN SAFE DIRECTION WELL CLEAR OF YOUR BODY, AND DO NOT TOUCH THE TRIGGER.

2. Draw hammer back to Half-Cock position (The cylinder is now free to rotate.)

3. Open loading gate by swinging it out to the right, exposing back of cylinder and a chamber. Check each of six chambers to ensure they are clean and free from accumulated oil. (Clean if necessary; see cleaning instructions.)

4. Use only ammunition recommended on page 4 of this instruction manual as suitable for your revolver. Insert a round of ammunition into chamber.

5. Press round home until it is fully seated.

6. Rotate cylinder clockwise to expose next empty chamber and insert a round as in steps 4 and 5 above; repeat until FIVE rounds are loaded.

CAUTION: LEAVE ONE CHAMBER EMPTY FOR SAFE CARRYING.

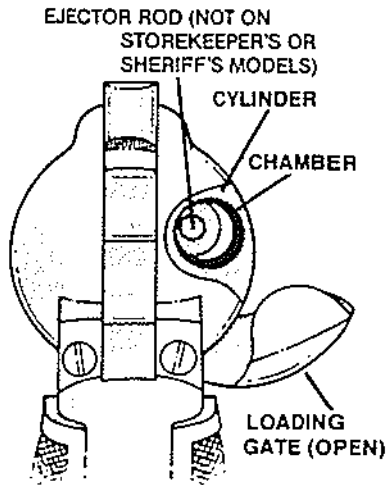

**FIGURE 7-
LOADING GATE OPEN**

⚠ CAUTION: INSURE EMPTY CHAMBER REMAINS IN FRONT OF HAMMER AND IN LINE WITH BARREL, so that if hammer falls forward, firing pin will not strike live round to cause accidental discharge.

7. KEEP REVOLVER POINTING IN SAFE DIRECTION. With thumb firmly on hammer spur, draw hammer back slightly to disengage the Half-Cock notch. Squeeze the trigger only long enough to allow hammer to move forward and clear Half-Cock notch, then release trigger completely so that Safety Notch can be properly engaged, and lower hammer controlling its movement with your thumb, into Safety position.

⚠ CAUTION: IF YOU DO NOT RELEASE TRIGGER FULLY BEFORE REACHING "SAFETY" POSITION, THE SAFETY NOTCH MAY NOT BECOME FULLY AND SAFELY ENGAGED, rendering it ineffective as a safety device.

IMPORTANT: It is sometimes possible that the bolt will not correctly engage cylinder to lock it so that empty chamber may not remain in front of hammer. Check for correct locking by attempting to rotate cylinder gently counterclockwise by hand. If it is already locked, the cylinder will not move. If it was unlocked, you should hear the bolt "click" into engagement with the cylinder to lock it.

8. Look at the rear of the cylinder to make sure the empty chamber is in front of the hammer; if it is, close the loading gate so that it is again flush with the revolver frame. If the empty chamber is not in front of the hammer, draw hammer back into Half-Cock notch, realign the cylinder and repeat items 6 through 8 until empty chamber is locked in front of hammer.

Alternate Loading Sequence

Follow "To Load" sequence except at Step 6 do this:

After loading first round as in Steps 4 and 5, leave next chamber empty. Then load remaining 4 chambers. This will position the empty chamber under the hammer when you rotate the cylinder and again see the first chamber you loaded.

CARRYING MODES

NOTE: This pistol may be carried in either of the following modes according to your needs:

Mode 1: — CYLINDER EMPTY

- Revolver cannot be discharged.
- Use Mode 1 for storage, transporting, cleaning, repair, demonstrating and dry practice.

Mode 2: — 5 CHAMBERS LOADED, WITH EMPTY CHAMBER UNDER HAMMER

- Revolver can be fired when hammer is cocked and trigger is squeezed.
- Use Mode 2 when you **MUST BE PREPARED** to use the revolver **IMMEDIATELY** without warning.



WARNING: When you squeeze the trigger, you must expect the gun to fire, and you must take full responsibility for firing it. Your care can avoid accidental discharge, and you will thereby avoid accidental injury and death.

UNLOADING

 **CAUTION: ALWAYS UNLOAD YOUR REVOLVER IMMEDIATELY AFTER USE, AND PRIOR TO CLEANING AND STORAGE, to minimize the risk of accidental discharge.**

 **CAUTION: ALWAYS EXERCISE EXTREME CARE TO KEEP MUZZLE POINTING IN A SAFE DIRECTION, WELL CLEAR OF YOUR BODY, PARTICULARLY WHEN UNLOADING REVOLVERS THAT DO NOT HAVE EJECTOR RODS.**

TO UNLOAD REVOLVERS WITH EJECTOR RODS

1. Be sure you are familiar with Safety Instruction in Section 3. **KEEP REVOLVER POINTING IN SAFE DIRECTION AND DO NOT TOUCH TRIGGER.**
2. Draw hammer back to Half-Cock position. (The cylinder is now free to rotate clockwise.)
3. Open loading gate.
4. **KEEPING FINGERS AWAY FROM TRIGGER**, align chamber as shown in Figure 8 and push ejector rod, (located under the barrel) backwards through cylinder chamber, forcing out the live round or empty case, which should be removed from revolver. Allow ejector rod to return forward under its spring action.

5. Rotate cylinder clockwise to align next chamber with ejector rod and repeat step 4 above; repeat until all chambers are empty.
6. Close loading gate.
7. With thumb firmly on hammer spur, draw hammer back slightly to disengage Half-Cock notch. Squeeze trigger only long enough to allow hammer to move forward and clear Half-Cock notch, then release trigger completely so that the Safety notch can be properly engaged. Lower hammer controlling its movement with your thumb, into Safety position.
8. Collect live ammunition for safe storage and empty cartridge cases for disposal.

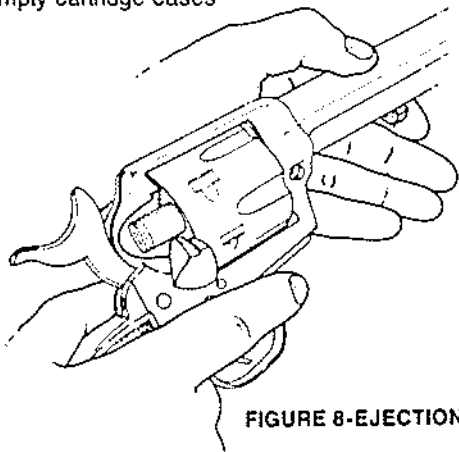

FIGURE 8-EJECTION



TO UNLOAD REVOLVERS WITHOUT EJECTOR RODS

CAUTION: ALWAYS EXERCISE EXTREME CARE TO KEEP MUZZLE POINTING IN A SAFE DIRECTION, WELL CLEAR OF YOUR BODY, PARTICULARLY WHEN UNLOADING REVOLVERS THAT DO NOT HAVE EJECTOR RODS.

1. Be sure you are familiar with Safety Instructions in Section 3. **KEEP REVOLVER POINTING IN SAFE DIRECTION AND DO NOT TOUCH TRIGGER.**
2. Draw hammer back to Half-Cock position. (The cylinder is now free to rotate clockwise.)
3. Open loading gate.
4. **KEEP FINGERS AWAY FROM TRIGGER**, align chamber as shown in Figure 8, tilt revolver muzzle up and remove cartridge as it slides back out of the chamber.
5. Rotate cylinder clockwise to align next chamber and repeat step 4 above; repeat until all chambers are empty.

NOTE: If cartridges or spent cases cannot be removed as described in steps 4 and 5, remove the cylinder as follows and use the base pin to push out the remaining rounds. See Figure 12.

- a. **KEEP MUZZLE POINTING IN A SAFE DIRECTION WELL CLEAR OF YOUR BODY AND** depress base pin retaining catch to release base pin. On Blackpowder frame revolvers use a properly fitting screwdriver to remove the base pin retaining screw.
- b. Remove base pin.

- c. Carefully remove cylinder to the right of frame avoiding contact between the ratchet and loading gate and contact with remaining live primers. **Take great care to avoid dropping cylinder and cartridges because one or more rounds may fire.**
 - d. Use base pin to remove remaining rounds until all chambers are empty.
 - e. Install empty cylinder and base pin.
 - f. On Blackpowder frame revolvers install and tighten base pin retaining screw.
6. Close loading gate.
 7. With thumb firmly on hammer spur, draw hammer back slightly to disengage Half-Cock notch. Squeeze trigger only long enough to allow hammer to move forward and clear Half-Cock notch, then release trigger completely so that the Safety notch can be properly engaged, and lower hammer, controlling its movement with thumb, into Safety position.
 8. Collect live ammunition for safe storage and empty cartridge cases for disposal.

FIRING AND SIGHT ADJUSTMENT

Before firing your Colt Single Action revolver, practice your stance, aim, rhythm and breathing for steady aim with your revolver UNLOADED. Practice firing on a range before going hunting or using your revolver for any other type of shooting. If you have a dual cylinder revolver learn to allow for the customary variation in point of bullet impact with different caliber cylinders installed. Different ammunition may also affect performance.

SAFETY DEPENDS ON YOU

The New Frontier is fitted with the adjustable Colt Accro rear sight. (See Figure 9). To adjust sight, turn windage screw clockwise and sight moves to left; counterclockwise and it moves to right. Turn elevation screw clockwise to lower sight; counterclockwise to raise it. Point of bullet impact will move in the same direction. It is recommended that adjustments for other than windage and elevation be made only by experienced persons.

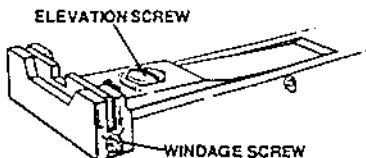

FIGURE 9- COLT ACCRO REAR SIGHT

CAUTIONS:

1. **ALWAYS WEAR AND ENCOURAGE OTHERS NEAR YOU TO WEAR EAR PROTECTION WHEN SHOOTING**, especially on a range. Without ear protection, the noise from your revolver and other guns close to you could leave a "ringing" in the ears for some time after firing, while the cumulative long term effect could be permanent hearing loss.
2. **ALWAYS WEAR AND ENCOURAGE OTHERS TO WEAR PROTECTIVE SHOOTING GLASSES**. Flying particles could damage eyes and cause blindness; but protective shooting glasses should prevent such injury.

WARNING: When you squeeze the trigger, you must expect the gun to fire, and you must take full responsibility for firing it. Your care can avoid accidental discharge, and you will thereby avoid accidental injury and death.



To Fire:

1. **CAUTION: READ SAFETY INSTRUCTIONS** (Section 3) — **KEEP REVOLVER POINTING IN SAFE DIRECTION AND DO NOT TOUCH THE TRIGGER.**

2. Load revolver as previously described.

3. **DO NOT TOUCH TRIGGER.** With your thumb firmly on hammer spur, draw hammer **FULLY** back (about an inch and three quarters) to "cocked" position and allow hammer to go slightly forward until "cocked" notch is engaged. Remove thumb from hammer spur.

4. Grasp revolver by grip and, with index finger resting along the outside of trigger guard, take aim. (Aim by aligning target with front and rear sights. See Figure 11. Then focus on the front sight.)

5. Keeping steady aim, place index finger on trigger and squeeze gently. Don't jerk the trigger as you will disturb your aim and spoil your accuracy.

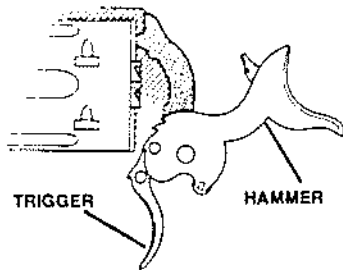

FIGURE 10—COCKED POSITION

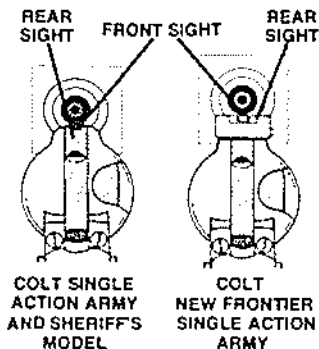

FIGURE 11—AIMING

6. Release trigger and remove index finger from trigger.



CAUTION: IF YOUR FIREARM FAILS TO FIRE, HOLD IT, KEEPING IT POINTED TOWARDS THE TARGET OR SAFE OPEN AREA AND WAIT 30 SECONDS. If a hangfire (slow ignition) has occurred, round will fire within 30 seconds. If round does not fire, eject it and examine primer; if firing pin indent of primer is light, off center, or non-existent, unload remaining rounds and have revolver examined by a competent gunsmith. If firing pin indent on primer appears normal (in comparison with similar previously fired rounds) assume faulty ammunition; segregate misfired round from other live ammunition and empty cases, and carry on firing.

NOTE: Dispose of misfired rounds in accordance with the ammunition manufacturer's instructions.

7. To fire second and subsequent rounds, repeat steps 3 through 6 above.

8. **KEEP REVOLVER POINTING IN SAFE DIRECTION.** Unload revolver as previously described.



CAUTION: NEVER LEAVE REVOLVER COCKED READY TO FIRE as this condition is **EXTREMELY** dangerous, and revolver could easily be accidentally discharged causing injury, death, or damage to property.

IMPORTANT: If you cock your revolver but do not fire it, return hammer to Safety position by placing thumb firmly on hammer spur and draw hammer back slightly to disengage Cocked notch. Squeeze trigger only long enough to allow hammer to move forward and clear Cocked notch, then release trigger completely. Half-Cock notch will then be engaged and cylinder must be rotated until empty chamber is in front of hammer. Draw hammer back slightly to disengage half-cock notch. Squeeze trigger only long enough to allow hammer to move forward and clear half-cock notch, then release trigger completely so that safety notch can be properly engaged. If you lose the opportunity to fire, unload your revolver as previously described.

 **CAUTION: IF YOU DO NOT RELEASE TRIGGER FULLY BEFORE REACHING SAFETY POSITION, SAFETY NOTCH MAY NOT BECOME FULLY ENGAGED, rendering it ineffective as a safety device.**

A Colt revolver, like any other precision mechanism, will function better and last longer when it is properly maintained. Follow the advice in this section to keep your revolver in peak condition.

⚠ CAUTION: ENSURE THAT THE REVOLVER IS NOT LOADED BEFORE STRIPPING AND CLEANING, so that it will not fire, and do not alter parts as the level of safety could be reduced.

Collector's revolver should not be stripped for cleaning. It should only be wiped gently, externally with a very soft dust-free cloth.

STRIPPING FOR CLEANING

1. Be sure you are familiar with "Safety Instructions" in Section 3.
2. Draw hammer back to Half-Cock position.
3. Open loading gate.
4. Rotate cylinder and ensure all six chambers are empty.
5. Remove cylinder as follows:
 - a. Depress base pin retaining catch (located on left side of frame in front of cylinder).
 - b. Keeping base pin retaining catch depressed, pull base pin forward and remove it from

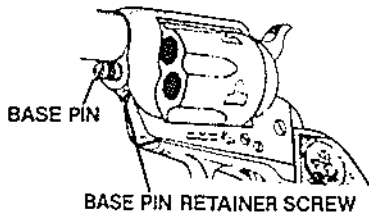
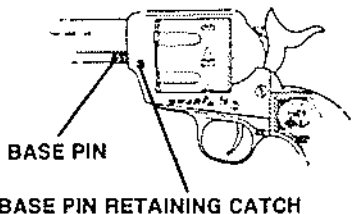

FIGURE 12A- BASE PIN REMOVAL

SAFETY DEPENDS ON YOU

revolver. Release retaining catch.

NOTE: Blackpowder frame revolvers have a base pin retaining screw in front of the frame which must be removed before base pin can be removed.

c. Carefully remove cylinder to the right of frame and avoid contact between the ratchet and loading gate.

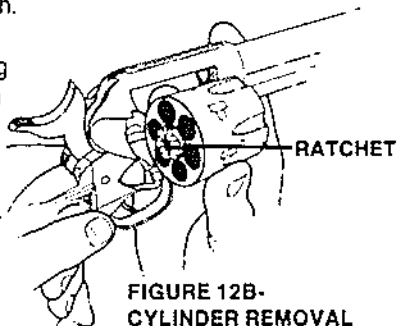

IMPORTANT: Do not strip your revolver further than removing the cylinder. If later additional maintenance is required see "Servicing and Repair" later in this instruction manual.

ASSEMBLING AFTER CLEANING

NOTE. Assemble in reverse order. With hammer at half-cock carefully install the cylinder by rolling it into the frame from the right side. Install and secure the base pin. Check that the cylinder rotates freely. Lower hammer to safety position and close the gate.

WHEN TO CLEAN

You should clean your revolver as soon after firing as possible so that the job will be easier and there will be less opportunity for corrosion to start. When your revolver has not be fired, clean it periodically; we

suggest once or twice a year in a temperate climate, or as often as once a month in a tropical climate. If you carry a loaded revolver, UNLOAD it and clean it at least once a month. If you get your revolver wet, clean it as soon as possible.

HOW TO CLEAN

A collector's revolver should only be wiped gently on the outside surfaces with a very soft dust-free cloth.

Others should be cleaned as follows:

The following cleaning procedure may be used both periodically and after firing; however, those items marked "*" are unnecessary for periodic cleaning.

Materials: Cleaning rod, cotton flannel patches (cut to fit snugly into the bore), a small tooth-brush, good quality light gun oil, *gun cleaning solution, and a brass wire bristle bore cleaning bush.

NOTE: In freezing conditions (below 32°F or 0°C) avoid the use of oil for lubrication; instead, apply a dry lubricant sparingly.

CLEANING PROCEDURE:



1. CAUTION: ENSURE THAT THE FIREARM IS NOT LOADED.

2. Strip for cleaning as previously described.

NOTE: Avoid contact between cleaning rod and muzzle as resultant wear will reduce accuracy. Take care to avoid striking rear frame of revolver as severe cases result in burring of the metal around firing pin hole which could contribute to eventual firing failures.

3. Attach cotton flannel patch to end of cleaning rod, insert it in muzzle and pass rod and patch down through barrel. Repeat, changing patches until last patch comes out clean.
4. Clean each of the six chambers in cylinder with similar method to step 3 above.
5. Visually inspect barrel and chambers; if they are clean, proceed directly to step 8, but if it remains dirty, continue with step 6.
6. ***(NOTE: This item should be applicable only after firing.)** Attach brass wire bristle brush to cleaning rod and dip brush in gun cleaning solution. Thoroughly scrub out barrel and cylinder chambers, passing the brush all the way through before reversing the movement. If you try to change direction with brush in barrel, the brush will stick.
7. Repeat steps 3, 4 and 5 above.
8. Clean rear face of barrel and revolver frame, using a small toothbrush.
9. Lightly moisten a flannel patch with gun oil and pass it once through the barrel, so leaving a thin film of oil on the inside surface. Leave this film of oil on the metal surface if revolver is to be stored. If it is not to be stored, or if it is being removed from storage for use, pass a dry patch through barrel and chambers to remove as much oil as possible. (See note on cold weather lubrication.)
10. Check that flannel or brush bristles have not become lodged in any part of revolver, then wipe all external surfaces with a flannel patch moistened with gun oil. (See note on cold weather lubrication.)

11. Reassemble revolver. See "Assembling After Cleaning."
12. Again wipe external surfaces with oil moistened patch to remove any fingerprints. (Finger moisture, if left, could start a corrosion process). (See note on cold weather lubrication).
13. Remove any gun cleaning solution and oil from grip.

STORAGE



CAUTION: ALWAYS UNLOAD YOUR REVOLVER FOR STORAGE AND STORE AMMUNITION SEPARATELY. Keep and store your revolver and ammunition securely locked in separate locations out of reach and sight of children. (Children are naturally curious and do not always believe the real danger of guns).

NOTE: Do not store your revolver in an air-tight container, and do not seal or attempt to seal the barrel or chambers to exclude dust, as the internal steel surfaces are more likely to corrode.

SERVICING AND REPAIR

Should your revolver require adjustment, or repair, make sure it is NOT loaded and send it to Colt's. For spare parts, seek advice from the Dealer who should have up to date information on how best to obtain genuine Colt parts.

An illustration and list of part names are included in the next section

of this instruction manual to help you identify the part you need, but it is important to note that all parts are not available for sale. Those parts which are available should be installed by Colt's or a competent gunsmith. When ordering parts, please give part name as given on the Parts List. Also give the caliber, model name, serial number and metal finish of your revolver, i.e., whether blue, nickel or stainless steel.

IMPORTANT: If you make unauthorized adjustments or use unauthorized parts, Colt will not assume responsibility for the functioning of this revolver.

THIS GUN IS MANUFACTURED TO PERFORM PROPERLY WITH THE ORIGINAL PARTS AS DESIGNED. IT IS YOUR DUTY TO MAKE SURE ANY PARTS YOU BUY ARE INSTALLED CORRECTLY AND THAT NEITHER REPLACEMENTS NOR ORIGINALS ARE ALTERED OR CHANGED. This is why we say return it to Colt's. YOUR GUN IS A COMPLEX TOOL WITH MANY PARTS THAT MUST RELATE CORRECTLY TO OTHER PARTS. PUTTING A GUN TOGETHER WRONG OR WITH MODIFIED PARTS CAN RESULT IN A DAMAGED GUN, DANGER, AND INJURY OR DEATH TO YOU AND OTHERS THROUGH MALFUNCTION. ALWAYS LET A QUALIFIED GUNSMITH WORK ON YOUR GUN AND CHECK ANY WORK YOU THINK WAS NOT PERFORMED BY A GUNSMITH. We at Colt think this is a small price to pay for firearms safety.

NOTE: Various Federal and State laws and local ordinances govern the transfer and transportation of firearms, so take the advice of the Dealer in your state on how to send your firearm to Colt's. Before shipping your revolver, here are some important points to remember:



1. CAUTION: MAKE SURE THAT THE FIREARM IS NOT LOADED.

2. Write a letter explaining the problem and your requirements in as much detail as possible. Include the model name and serial number of your revolver together with your return address, then enclose it with the gun in a well padded package.

3. Do not send presentation boxes, accessories or ammunition.

4. Colt's address for receiving packages is: CMCI
Talcott Road
West Hartford, CT 06110

5. Do not indicate the contents, or include "COLT" in the address on the package so that an inquisitive thief is not attracted to it by such information.

6. Insure the package contents against loss or theft.

7. **DO NOT** ship your revolver if you cannot read its serial number. Federal law requires that serial numbers be legible for transfer to be legal. To find your serial number, turn revolver upsidedown and look at the bottom of the frame just in front of the trigger guard.

SECTION 6**PARTS ILLUSTRATION AND LIST**

This section is provided so that you may identify names of parts for your own interest. However, for adjustment, repair or spare parts information, see Section 5 "Servicing and Repair."

See page 40 for illustration.

See page 41 for names of parts.

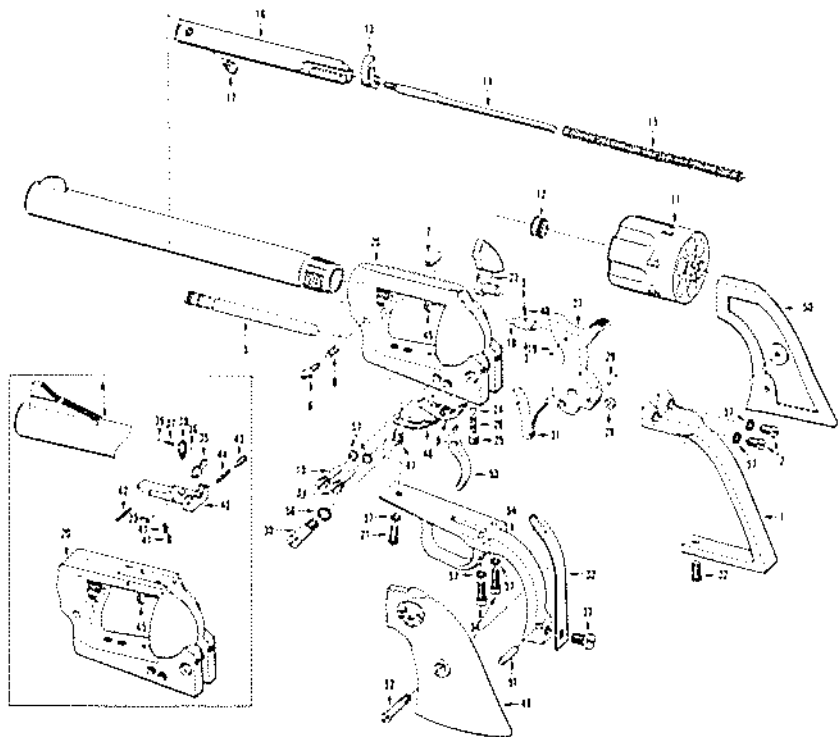

Fig. 13-Colt Single Action Army Revolver — Parts Illustration — with inset of parts peculiar to Colt New Frontier Single Action Army revolvers.

DESCRIPTION

- | | | |
|------------------------------|--------------------------------------|----------------------------------------------|
| 1. Backstrap | 23. Gate | 44. Rear Sight Windage Spring |
| 2. Backstrap Screw (2) | 24. Gate Catch | 45. Recoil Plate |
| 3. Ball (2) (same as no. 36) | 25. Gate Catch Screw | 46. Sear and Bolt Spring |
| 4. Barrel | 26. Gate Spring | 47. Sear and Bolt Spring Screw |
| 4 $\frac{3}{4}$ " | 27. Hammer Assembly | 48. Spring (same as no. 37) |
| 5 $\frac{1}{2}$ " | 28. Hammer Roll | 49-50. Stock Assembly:
Composition Rubber |
| 7 $\frac{1}{2}$ " or 12" | 29. Hammer Roll Pin | Wood (Walnut) |
| 5. Base Pin | 30. Hammer Screw | 51. Stock Pin |
| 6. Base Pin Screw | 31. Hand | 52. Stock Screw |
| 7. Base Pin Screw Nut | 32. Main Spring | 53. Trigger |
| 8. Base Pin Spring | 33. Main Spring Screw | 54. Trigger Guard |
| 9. Bolt | 34. Rear Guard Screw (2) | 55. Trigger Screw |
| 10. Bolt Screw | 35. Rear Sight Blade | 56. Washer |
| 11. Cylinder | 36. Rear Sight Det. Ball (2) | 57. Washer No. 8 (7) |
| 12. Cylinder Spacer | 37. Rear Sight Det. Spring | |
| 13. Ejector Head | 38. Rear Sight Elev. Screw | |
| 14. Ejector Rod | 39. Rear Sight Elev. Screw Pin | |
| 15. Ejector Spring | 40. Rear Sight Leaf | |
| 16. Ejector Tube | 41. Rear Sight Leaf Elev. Spring (2) | |
| 17. Ejector Tube Screw | 42. Rear Sight Leaf Pin | |
| 18. Firing Pin | 43. Rear Sight Windage Screw | |
| 19. Firing Pin Rivet | | |
| 20. Frame | | |
| 21. Front Guard Screw | | |
| 22. Front Strap Screw | | |

Note. Items 13 through 17 are not applicable to the SHERIFF'S MODEL. Black powder frame Sheriff's and Storekeeper's models do not have items 6 and 8 as illustrated. Item 6 is replaced by a screw located on front of frame.

Our Colt Custom Shop offers a wide range of special services such as engraving, inlaying and special serializing to the same high standard of quality long synonymous with the name "COLT." Sometimes modifications, which meet our customer's special requirements, necessitate deviations from standard design and manufacturing tolerances which result in functional differences from a standard gun. Consequently, this instruction manual does not apply to a customized gun unless its applicability has been confirmed by the Colt Custom Shop. For further information, write to Colt's Manufacturing Company, Inc., Custom Gun Shop, P.O. Box 1868, Hartford, Connecticut 06144-1868, USA.

FIREARM RECORD

Colt Model _____

Serial No. _____

Caliber _____

Purchased
from _____

Date
Purchased _____

Purchase
Price _____

WARRANTY STATEMENT

Based on Magnuson-Moss Warranty Act, Colt offers no express warranty on its product line. However, Colt recognizes its obligations concerning implied warranty. Colt also stands behind its products as it has historically, and will continue to provide services to its product line as it has over the years. Colt products will be serviced for a period of one year from the date of retail purchase, for defects in materials or workmanship, at no charge to the purchaser. Be sure to retain your sales slip as proof of purchase date when making a claim.

HEALTH AND ENVIRONMENTAL WARNING



Discharging firearms in poorly ventilated areas, cleaning firearms, or handling ammunition may result in exposure to lead and other substances known to cause birth defects, reproductive harm, cancer, and other serious physical injury. Have adequate ventilation at all times. Wash hands thoroughly after exposure.

If your instruction manual becomes lost or destroyed, obtain a replacement by writing to **Colt's Manufacturing Company, Inc., Box 1868, Hartford, Connecticut 06144-1868, USA** or call **1-800-962-COLT**. Make a note of the address. When requesting a manual, include the information which is on the left side of your firearm together with its serial number or quote the Part No. as shown on the back cover of this manual.



, the Rampant Colt figure, New Frontier® and all other Colt trademarks are the exclusive property of Colt's Manufacturing Company, Inc. For permission to reprint for noncommercial instructional purposes, prior approval from Colt's is required.

This instruction manual should always accompany this firearm. When you lend, give or sell this firearm, be sure this manual goes with it.



Avvertimento Italiano:

Se c'è qualcosa che non riuscite a capire, rivolgetevi a qualcuno che sia qualificato nel maneggiare in maniera sicura le armi da fuoco.

Advertencia en Español:

Para cualquier aclaración de esta manual, consulte con alguna persona perita en el manejo seguro de armas de fuego.

Message Seculaire en Français:

Pour tous renseignements complémentaires, veuillez consulter un armurier qualifié dans le maniement de ces armes.

Deutsche Sicherheitshinweise:

Sollten Sie noch weitere Fragen haben, wenden Sie sich bitte an einen Waffenspezialisten.

FUNDAMENTAL NRA RULES FOR SAFE GUN HANDLING

- 1. ALWAYS KEEP THE GUN POINTED IN A SAFE DIRECTION.**
- 2. ALWAYS KEEP YOUR FINGERS OFF THE TRIGGER UNTIL READY TO SHOOT.**
- 3. ALWAYS KEEP THE GUN UNLOADED UNTIL READY TO USE.**