

SAFETY AND INSTRUCTION MANUAL

Baby Eagle® II & III Pistols

9mm Para. /.40 S&W /.45 ACP



STEEL MODELS

Full Size: 9mm, .40 S&W, .45 ACP
Semi-Compact: 9mm, .40 S&W, .45 ACP



POLYMER MODELS

Full Size: 9mm, .40 S&W
Semi-Compact: 9mm, .40 S&W



**Read the instructions and warnings in this manual
CAREFULLY BEFORE using this firearm.**

Manufactured by
BUL LTD.

Imported by
MAGNUM RESEARCH, INC.®

Factory: 12602 33rd Avenue SW, Pillager, MN 56473
Sales: 218.746.3459
Support & Service: 218.746.3459 | Fax: 218.746.3097
Website: www.MagnumResearch.com





WARNING

**ALL FIREARMS ARE DANGEROUS OBJECTS - PISTOLS INCLUDED.
ALWAYS CONSIDER THE PISTOL LOADED. TO RENDER IT SAFE, FIRST SET THE SAFETY ON THE "SAFE" POSITION OR DOWN POSITION; REMOVE THE MAGAZINE, THEN EJECT ANY REMAINING ROUNDS BY PULLING THE SLIDE TO THE REAR.**

IT IS DANGEROUS TO ALTER OR MODIFY THIS FIREARM IN ANY WAY. ANY ALTERATIONS OR MODIFICATIONS OF THE FIRING MECHANISM MAY RESULT IN THIS FIREARM BECOMING UNSAFE, AND WILL NULLIFY ALL WARRANTIES.

USER IS ADVISED TO READ THE ENTIRE MANUAL PRIOR TO HANDLING THIS PISTOL AND OPERATING IT FOR THE FIRST TIME.



WARNING

CHILDREN ARE ATTRACTED TO AND CAN OPERATE FIREARMS THAT CAN CAUSE SEVERE INJURIES OR DEATH. PREVENT CHILD ACCESS BY ALWAYS KEEPING FIREARMS LOCKED AWAY AND UNLOADED WHEN NOT IN USE. IF YOU KEEP A LOADED FIREARM WHERE A CHILD OBTAINS AND IMPROPERLY USES IT, YOU MAY BE FINED OR SENT TO PRISON.

The above statement, provided as required by California statute 12088.3

TABLE OF CONTENTS

1.	PREFACE	3
2.	CAUTION	3
3.	SAFETY PRECAUTIONS	4
4.	GENERAL DESCRIPTION AND CHARACTERISTICS	4
5.	TECHNICAL DATA	5
6.	OPERATING PRINCIPLES	6
7.	OPERATING INSTRUCTIONS	7
8.	SIGHTS AND ZEROING	8
9.	LOADING, FIRING AND UNLOADING	9
10.	DISASSEMBLY AND ASSEMBLY	11
11.	CARE AND CLEANING	12
	PARTS LIST & EXPLODED VIEW - STEEL FRAME MODEL	14
	PARTS LIST & EXPLODED VIEW - POLYMER FRAME MODEL	15
12.	CONTACT & SHIPPING FOR SERVICE	17
	LIMITED ONE-YEAR WARRANTY	18
	LIMITATION OF LIABILITY	19

1. PREFACE

Welcome to the proud family of “Baby” Eagle owners. This instruction manual refers to “Baby” Eagle pistols in:

- 9mm parabellum (9x19)
- .40 S&W
- .45 ACP

Care and handling are the same for all calibers. They share many parts in common as well, but not all; and are not interchangeable between calibers.

ATTENTION

The operating instructions in this manual refer to the “Baby” Eagle R model pistols (slide-mounted de-cocking safety).

Be sure to disassemble and clean your pistol according to the manual prior to initial use. Failure to do so may cause the pistol to malfunction.

2. CAUTION

Failure to heed the warnings in this booklet may result in serious injury or death to you or others, as well as damage to the firearm or other property. Take note of the following warnings on firearm handling before attempting to use the pistol:

- **Always check the chamber and magazine of any firearm before handling.**
- **Never load or carry a loaded firearm until you are ready to use it.**
- **Always keep muzzle pointed in a safe direction.**
- **Keep firearms and ammunition separate and in locked storage.**
- **Don't shoot unless absolutely sure of your target and what is beyond it.**
- **Know the range of your firearm.**
- **Always wear eye and ear protection when shooting.**
- **Always be sure the barrel is clear of obstructions and only use factory ammunition specifically intended for the firearm you are using.**
- **Never use alcohol or drugs of any kind while handling/using your firearm.**
- **Always store your firearm in a safe and responsible manner to prevent unauthorized use. Cable locks are provided with all firearms sold by Magnum Research, Inc.**

3. SAFETY PRECAUTIONS

Pushing the safety downward will engage the safety and drop/decock the hammer. Make sure that the pistol is unloaded and in the “SAFE” or decocked position before:

- Receiving or handing over a pistol.
- Transporting a pistol.
- Cleaning or servicing a pistol.

Immediately after firing, set the safety on the “SAFE” position or down position, remove the magazine and make sure the chamber is empty.

Make sure that the safety is in the “SAFE” position or down position when:

- Inserting the magazine.
- You have stopped firing.
- Transporting or moving the pistol.
- The pistol is not in use.

When handling the pistol:

- Never point it at anyone.
- Practice handling the pistol empty.
- Always make sure that the barrel points in a safe direction.
- Always assume that the pistol is loaded.
- Never load a pistol until you are ready to use it.

Before firing the pistol:

- Wear ear and eye protection.
- Always be sure of your target backstop and what lies beyond it.
- Make sure that the barrel, the magazine, and ammunition are of the same caliber.

4. GENERAL DESCRIPTION AND CHARACTERISTICS

The “Baby” Eagle pistol made by BUL LTD. is a semi-automatic magazine fed, double action/single action pistol. The safety of the “Baby” Eagle pistol locks the firing pin, decocks the hammer and also disconnects the trigger mechanism.

In addition to the high accuracy and low recoil, the “Baby” Eagle pistol offers the convenience of firing factory 9mm Parabellum (9 x 19), .40 S&W and .45 ACP ammunition in pistols with corresponding or marked caliber designations.

The ergonomically formed grip dimensions permit rapid, accurate, instinctive shooting. The combat style trigger guard is designed for two-handed shooting.

SLIDE-MOUNTED SAFETY MODELS

An easily operated slide-mounted thumb safety and deep-groove serrated slide grip are designed for positive operation.

5. TECHNICAL DATA

STEEL FRAME MODELS SPECIFICATIONS

Size	Full Size	Semi-Compact	Full Size	Semi-Compact	Full Size	Semi-Compact
Caliber	9mm		.40 S&W		.45 ACP	
Barrel Length	4.43"	3.85"	4.43"	3.85"	4.43"	3.85"
Height	5.375"	5.375"	5.375"	5.375"	5.375"	5.375"
Weight	38 oz	35 oz	38 oz	35 oz	35.8 oz	34.2 oz
OA Length	8"	7.5"	8"	7.5"	8"	7.5"
Slide Width	.98"	.98"	.98"	.98"	.98"	.98"
Construction	High quality carbon steel frame and slide					
Finish	Black oxide finish					
Trigger	Double Action/Single Action (DA/SA)					
Trigger Pull	12 lbs (DA), 4 lbs (SA)					
Rifling	6 Right Hand grooves, polygonal					
Safety	Slide mounted safety and decocker, ambidextrous					
Sights	Combat type, white three dot, fixed					
Magazine	2-15 rd	2-15 rd	2-12 rd	2-12 rd	2-10 rd	2-10 rd

POLYMER FRAME MODELS SPECIFICATIONS

Size	Full Size	Semi-Compact	Full Size	Semi-Compact
Caliber	9mm		.40 S&W	
Barrel Length	4.43"	3.85"	4.43"	3.85"
Height	5.75"	5.75"	5.75"	5.75"
Weight	28.6 oz	26.3 oz	28 oz	25 oz
OA Length	8.375"	7.825"	8.375"	7.825"
Slide Width	1.1"	1.1"	1.1"	1.1"
Construction	Polymer frame with high quality carbon steel slide			
Finish	Black textured polymer frame, black oxide on slide			
Trigger	Double Action/Single Action (DA/SA)			
Trigger Pull	12 lbs (DA), 4 lbs (SA)			
Rifling	6 Right Hand grooves, polygonal			
Safety	Slide mounted safety and decocker, ambidextrous			
Sights	Combat type, white three dot, fixed			
Magazine	2-15 rd	2-15 rd	2-12 rd	2-12 rd

6. OPERATING PRINCIPLES

RETRACTION MOVEMENT

Prior to firing the pistol, the barrel is locked in position by three lugs engaged in two slots in the slide assembly. Upon firing the pistol, propellant gas pressure pushes the slide rearward. During this movement, both barrel and slide recoil together a short distance, then the barrel stops and disengages from the slide; the slide continues its rearward travel. When the bullet has left the barrel, the empty cartridge case is extracted and ejected with the continuing movement of the slide to the rear. At the same time, the slide pushes the hammer down into the cocked position, where it is retained by the sear. The recoil springs are now compressed.

FORWARD MOVEMENT

When the recoil springs expand, they drive the slide forward. During this movement the slide strips a cartridge from the magazine and inserts it into the chamber. The locking lugs on the barrel once again engage the slots in the slide and lock the cartridge in the chamber.

CONTINUED FIRING

When the trigger is pulled, the sear releases the hammer which in turn hits the firing pin thus firing the chambered cartridge. Firing may be continued in this manner until the magazine is empty. When the last cartridge is fired and the empty case is ejected the slide is retained in its rear position by the slide catch. The slide catch is actuated by the magazine follower. The slide catch will release the slide when depressed by hand.

SAFETY FEATURES

The safety is located at the back of the slide, just below the rear sight. Pushing the safety downward will engage the safety. In this position the sear is held down by the firing pin safety and the trigger bar, which is pushed downward and cannot engage the interrupter thus neutralizing the trigger. The safety is also a decocking device which pulls the firing pin inside the firing pin channel before the hammer is released, preventing any contact between them. Due to the unique blocking of the firing pin by the safety, the pistol will not fire when dropped accidentally on its hammer or muzzle.

7. OPERATING INSTRUCTIONS

BEFORE OPERATING THE PISTOL

1. Move the safety down into the “SAFE” position or down position (7 Fig. 1): a white dot will be visible.
2. Press the magazine release button on the left hand side of the pistol (7 Fig. 2), and remove the magazine.
3. Move the safety lever up into the “FIRE” position (7 Fig. 3): a red dot will be visible.
4. Draw the slide to the rear, and check the chamber visually to ensure that the pistol is unloaded. (7 Fig. 4): Release the slide.
5. Point the pistol in a safe direction and pull the trigger (7 Fig. 5).
6. Cock the pistol again by pulling the slide rearward and then release the hammer by moving the safety down to “SAFE” position or down position (decocking test).
7. Point the pistol a safe direction, and check that the trigger is neutralized.
8. Move the safety up to the “FIRE” position and then pull the trigger, checking the double-action mechanism.
9. Move the safety down to the “SAFE” position or down position.



7 Fig. 1



7 Fig. 2



7 Fig. 3



WARNING:

The “Baby” Eagle pistol can be fired with the magazine removed and a round in the chamber. Always clear the chamber when unloading the pistol.



AMMUNITION WARNING:

Use only original, high quality, commercially manufactured ammunition which is in good condition. Only use ammunition of the caliber for which your pistol is chambered. You will find the correct caliber engraved on the barrel. Never use ammunition of any other caliber. You should always use ammunition that complies with performance standards established by The Sporting Arms and Ammunition Manufacturers’ Institute, Inc. The use of hand-loaded or other non-standard ammunition such as +P or +P+ will void all warranties.

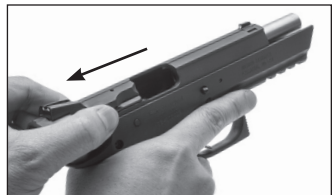

7 Fig. 4



7 Fig. 5

LOADING THE MAGAZINE

1. With the magazine in an upright position, place a cartridge on the magazine follower, in front of the magazine lips.
2. Press the cartridge down and slide it under the magazine lips, push the cartridges all the way to the rear of the magazine (7 Fig. 6).
3. Repeat the process until fully loaded.



7 Fig. 6

EMPTYING THE MAGAZINE

1. Push the cartridges forward with your thumb until they are out from under the magazine lips.
2. Repeat until the magazine is empty (7 Fig. 7).



7 Fig. 7

CAUTION:

**Damaged or bent magazine lips will cause a malfunction.
Do not force cartridges.**

8. SIGHTS AND ZEROING

Standard “Baby” Eagle pistol sights consist of a front and rear sight. Both are combat style, and are designed to ensure rapid and accurate aiming. The square notch on the rear sight is 3 mm (.118”) wide and the front sight blade is 3.3 mm (.130”) wide.

We recommend using a 6 o’clock hold when shooting.

Due to individual eyesight variations, the actual mean point of impact (M.P.I.) may vary. Zeroing can be changed on combat style sights for windage only. To adjust the sights:

1. Use a small hammer and a brass punch to lightly tap the sight on the side. (Moving the rear sight to the left will move the point of impact to the left).
2. Adjustments to the sights in this manner should only be performed by a competent gunsmith.

9. LOADING, FIRING AND UNLOADING

PRE-LOADING AND PRE-FIRING CHECKS

1. Perform the safety checks listed on page 7 (1 - 9) to ensure that the pistol is not loaded and functioning properly.
2. Make sure that the barrel is clean and dry (all factory packing grease should be removed from all surfaces before firing the pistol for the first time), by not doing so could cause malfunctions.
3. Check that the magazine is clean and properly loaded.
4. Always wear ear and eye protection when firing the pistol.

COCKING THE PISTOL

5. Never chamber a round unless you are ready to fire.
6. Verify that the safety is on “SAFE” position or down position.
7. Insert the magazine into the pistol (9 Fig. 1).
8. Grasp the slide, pull it all the way back and release it (9 Fig. 2). This operation chambers a cartridge.

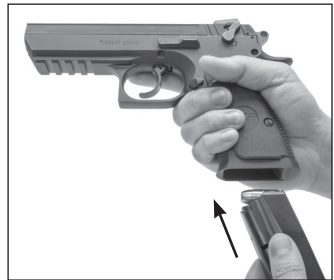

9 Fig. 1



WARNING:

- The pistol is now loaded - make sure that the barrel is pointed in a safe direction.
- Keep your index or trigger finger out of the trigger guard while cocking.
- If pistol is cocked when safety is in “FIRE” position, hammer will remain cocked.

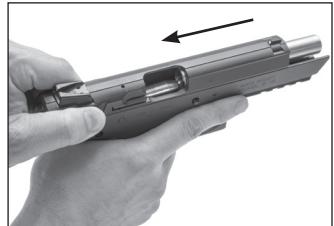

9 Fig. 2

FIRING THE PISTOL

1. With the pistol pointed at the target, move the safety to the “FIRE” position (RED dot will be visible).
2. AIM and pull the trigger (9 Fig. 3).

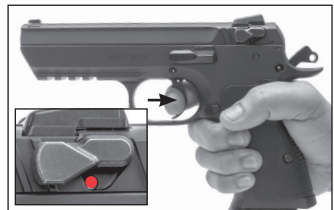

9 Fig. 3

RELOADING DURING FIRING

The slide will remain in the rear position after the last cartridge is ejected and the magazine is empty. (9 Fig. 4)

1. Remove the empty magazine.
2. Insert a full magazine.



9 Fig. 4

3. Release the slide by depressing the slide catch lever (9 Fig. 5) or by pulling the slide slightly to the rear and releasing it.



WARNING:

The pistol is now loaded and cocked with the safety in the “FIRE” position.



9 Fig. 5



OBSTRUCTION WARNING:

- **Always clean all grease and oil from the chamber and the bore before loading.**
- **Be sure there is no obstruction in the barrel.**

A foreign object in the barrel could cause a barrel rupture/bulge or other damage to the firearm as well as serious injury to the shooter or to others.

- While the firearm is unloaded, it is the sole responsibility of the user to check the bore for obstructions before discharging the firearm.
- Always visually check the unloaded chamber and bore after a misfire or any odd sounding high or low report.
- Discontinue firing until the obstruction, full or partial, is cleared. “Warranty Claims” resulting from an uncleared obstruction will not be covered by the warranty.
- Always wear shooting glasses.

UNLOADING THE PISTOL

1. Set the safety in the “SAFE” position or down position.
2. Press the magazine release button and remove the magazine.
3. Pull the slide to the rear and eject any chambered cartridge.
4. While the slide is in the rear position, visually check to make certain that the chamber is empty.
5. Return the slide to the forward position.
6. Confirm the safety is in the “SAFE” position or down position.
7. Remove all the cartridges from the magazine (see Loading and Emptying the magazine, page 8).
8. Replace the empty magazine in the pistol.



WARNING:

The “Baby” Eagle pistol can be fired with magazine removed and a round in the chamber. Always clear chamber when unloading pistol.

10. DISASSEMBLY AND ASSEMBLY

GENERAL

This chapter deals with those disassembly and assembly operations which the user should carry out for routine maintenance of the pistol.

Disassembling or assembling of any other parts is not recommended and will void all warranties.

Disassembly should be carried out on a clean surface. All the disassembled parts should be placed in order of their removal.

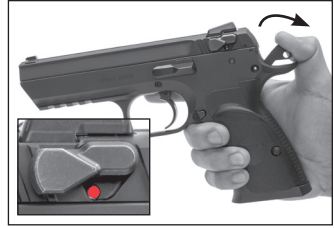

10 Fig. 1

CAUTION:

Carry out the following operations before disassembling:

- 1. Remove the magazine (7 Fig. 2).**
- 2. Move the safety to the “FIRE” position (7 Fig. 3).**
- 3. Draw back the slide several times (without pulling the trigger) to ensure that there are no live cartridges in the chamber.**
- 4. Check the chamber visually to make sure that it is empty (7 Fig. 4).**



10 Fig. 2

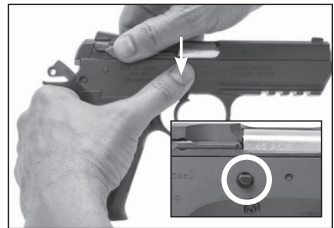

10 Fig. 3

DISASSEMBLING THE PISTOL

- With the pistol completely unloaded, and safety in the “FIRE” position, manually move the hammer to the cocked position (10 Fig. 1).
- Push the slide slightly to the rear until the mark behind the safety is just above the mark on the frame (10 Fig. 2).
- While holding the pistol in that position, remove the slide catch lever by pushing in on the pin of the lever on the opposite side of the frame (10 Fig. 3).
- Pull the slide from the frame (10 Fig. 4).
- Remove the recoil spring assembly from its housing under the barrel (10 Fig. 5). The recoil spring rod and recoil springs are under tension and care should be taken while removing.
- Remove the barrel from the slide (10 Fig. 6 on page 12).

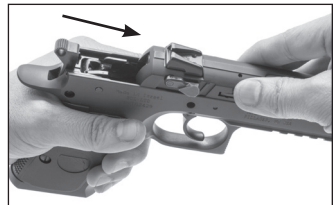

10 Fig. 4



10 Fig. 5



WARNING:

No further disassembly is required or advised for routine maintenance. See Care and Cleaning.

ASSEMBLING THE PISTOL

1. Insert the barrel into the slide in its rearmost (locked) position (10 Fig. 7).
2. Insert the recoil spring assembly, making sure that it is securely fitted into the recess in the bottom lug of the barrel (10 Fig. 8). The cone-shaped end of the recoil spring assembly fits into the barrel lug.
3. Manually move the hammer to the cocked position.
4. Mount the slide on the frame (10 Fig. 9) and push it to the rear until the marks are in line, one above the other, then insert the slide catch pin until it snaps into place (10 Fig. 10).
5. Check correct pistol operation by cocking it.
6. Check trigger and hammer operation and verify that safety is functioning properly and safely (see page 7, 1 - 9).



10 Fig. 6

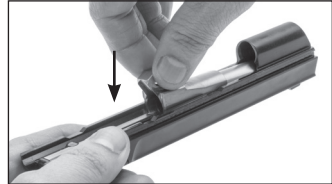

10 Fig. 7



10 Fig. 8

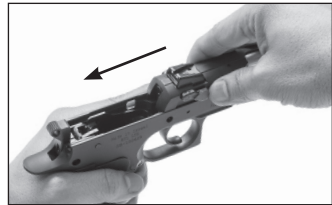

10 Fig. 9

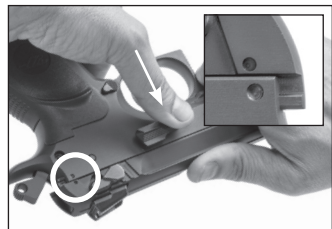

10 Fig. 10

11. CARE AND CLEANING

GENERAL

Comprehensive knowledge of how to service and handle the pistol is of great importance. Experience has shown that most failures which occur while operating the pistol are due to negligence in maintenance. Special attention must be paid to cleaning, lubricating and inspecting the pistol; this will determine whether or not the pistol functions properly when you need it. In order to maintain accuracy, the barrel must be serviced thoroughly. The slide and other moving parts of the pistol must be kept clean and lightly lubricated to ensure proper operation. Care and cleaning includes the magazine, which must be kept free from rust, grit, etc., in order to function properly.

CLEANING THE PISTOL

1. Upon receiving the pistol, disassemble and inspect it (see page 11-12, Disassembly).
2. Clean the pistol regularly to ensure it functions properly when needed.
3. For the initial cleaning, make certain that any heavy or sticky deposits of protective material are removed. To do so, use a very light rust-preventative oil to remove the coating.
4. When cleaning the slide, pay particular attention to the area around the extractor and firing pin, making certain that all powder residue is removed (11 Fig. 2). A small brush, swabs and solvent should be used to remove debris from hard to reach areas. (11 Fig. 1).
5. To clean the barrel, use the brass wire brush. Run the brush completely through the chamber and bore until it protrudes from the other end of the barrel.
6. Pull the brush in the opposite direction and remove it from the barrel (11 Fig. 2). Repeat this operation several times.
7. Use a patch moistened with powder solvent and clean the bore (11 Fig. 3). Repeat this operation using clean, dry patches.
8. Oil the chamber, bore and all moving parts of the pistol with a lightly oiled patch/cloth, then remove all excess oil with a dry one (11 Fig. 4).
9. While cleaning, inspect all parts for wear and damage; make sure all surfaces are free from rust.
10. Assemble the pistol and make sure it functions properly.
11. Never use abrasive or metallic objects, synthetic cloth, dry cleaning fluids, detergents, acids, lyes, water or steam for cleaning.

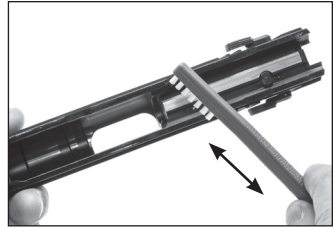

11 Fig. 1

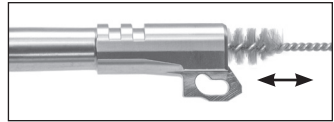

11 Fig. 2



11 Fig. 3

LUBRICATION

After cleaning the entire pistol, use a cloth to apply a light film of high quality gun rust preventing oil to all external metal surfaces and wipe clean.

Do not over-lubricate the pistol to the extent where lubricant will be dripping or running down the firearm. Excess lubricant can attract dirt, unburned powder and carbon residue, which can interfere with proper functioning of the pistol.

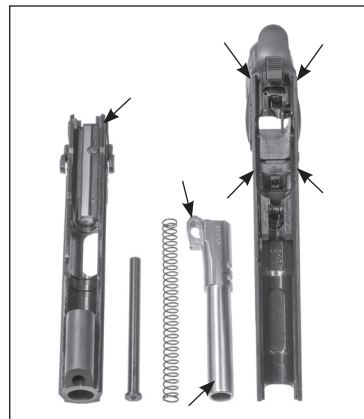

11 Fig. 4: Lubrication Points

PARTS LIST Baby Eagle® III Pistols

STEEL FRAME MODEL 9mm Para. / .40 S&W / .45 ACP

<p>No. Description</p> <p>1 Frame</p> <p>2 Slide</p> <p>3 Barrel</p> <p>4 Recoil Spring Guide Rod</p> <p>5 Recoil Spring</p> <p>6 Extractor Spring</p> <p>7 Extractor</p> <p>8 Extractor Pin</p> <p>9 Safety Plunger</p> <p>10 Plunger Spring</p> <p>11 Safety Lever (Left)</p> <p>12 Firing Pin Safety Spring</p> <p>13 Firing Pin Safety</p> <p>14 Automatic Firing Pin Safety Spring</p> <p>15 Automatic Firing Pin Safety</p> <p>16 Firing Pin Plate</p> <p>17 Safety Lever (Right) Pin</p> <p>18 Safety Lever (Right)</p> <p>19 Firing Pin Spring</p> <p>20 Firing Pin</p> <p>21 Slide Catch Spring Pin</p> <p>22 Slide Catch Spring</p> <p>23 Hammer Spring</p> <p>24 Magazine Catch</p> <p>25 Magazine Catch Spring</p> <p>26 Magazine Catch Plunger</p> <p>27 Hammer Pin</p> <p>28 Slide Catch</p> <p>29 Trigger Pin</p>		<p>30 Trigger</p> <p>31 Trigger Spring</p> <p>32 Trigger Bar</p> <p>33 Trigger Bar Pin</p> <p>34 Trigger Bar Guide</p> <p>35 Trigger Bar</p> <p>36 Trigger Bar Plunger</p> <p>37 Trigger Bar Plunger Pin</p> <p>38 Sear</p> <p>39 Sear Pin</p> <p>40 Sear Spring</p> <p>41 Sear Housing</p> <p>42 Sear Housing Pin</p> <p>43 Hammer</p> <p>44 Hammer Strut</p> <p>45 Hammer Strut Pin</p> <p>46 Interruptor</p> <p>47 Interruptor Pin</p> <p>48 Front Sight</p> <p>49 Rear Sight</p> <p>50 Grip</p> <p>51 Grip Screw</p>	
--	--	--	--

POLYMER FRAME MODEL 9mm Para. / .40 S&W

No. Description

- 1 Frame
- 2 Slide
- 3 Barrel
- 4 Recoil Guide Rod
- 5 Recoil Spring
- 6 Extractor Spring
- 7 Extractor
- 8 Extractor Pin
- 9 Safety Plunger
- 10 Plunger Spring
- 11 Safety Lever (Left)
- 12 Firing Pin Safety Spring
- 13 Firing Pin Safety
- 14 Automatic Firing Pin Safety Spring
- 15 Automatic Firing Pin Safety
- 16 Firing Pin Plate
- 17 Safety Lever (Right) Pin
- 18 Safety Lever (Right)
- 19 Firing Pin Spring
- 20 Firing Pin
- 21 Slide Catch Spring Pin
- 22 Slide Catch Spring
- 23 Hammer Spring
- 24 Magazine Catch
- 25 Magazine Catch Spring
- 26 Magazine Catch Plunger
- 27 Hammer Pin
- 28 Slide Catch
- 29 Trigger Pin

Trigger Assembly

- 30 Trigger
- 31 Trigger Spring
- 32 Trigger Bar
- 33 Trigger Bar Pin

Trigger Plunger Assembly

- 34 Trigger Bar Guide
- 35 Trigger Bar
- 36 Trigger Bar Plunger
- 37 Trigger Bar Plunger Pin

Sear Assembly

- 38 Sear
- 39 Sear Pin
- 40 Sear Spring
- 41 Sear Housing
- 42 Sear Housing Pin

Hammer Assembly

- 43 Hammer
- 44 Hammer Strut
- 45 Hammer Strut Pin
- 46 Interruptor
- 47 Interruptor Pin

48 Front Sight

- 49 Rear Sight
- 50 Front Insert
- 51 Front Insert Pin
- 52 Rear Insert
- 53 Rear Insert Pin

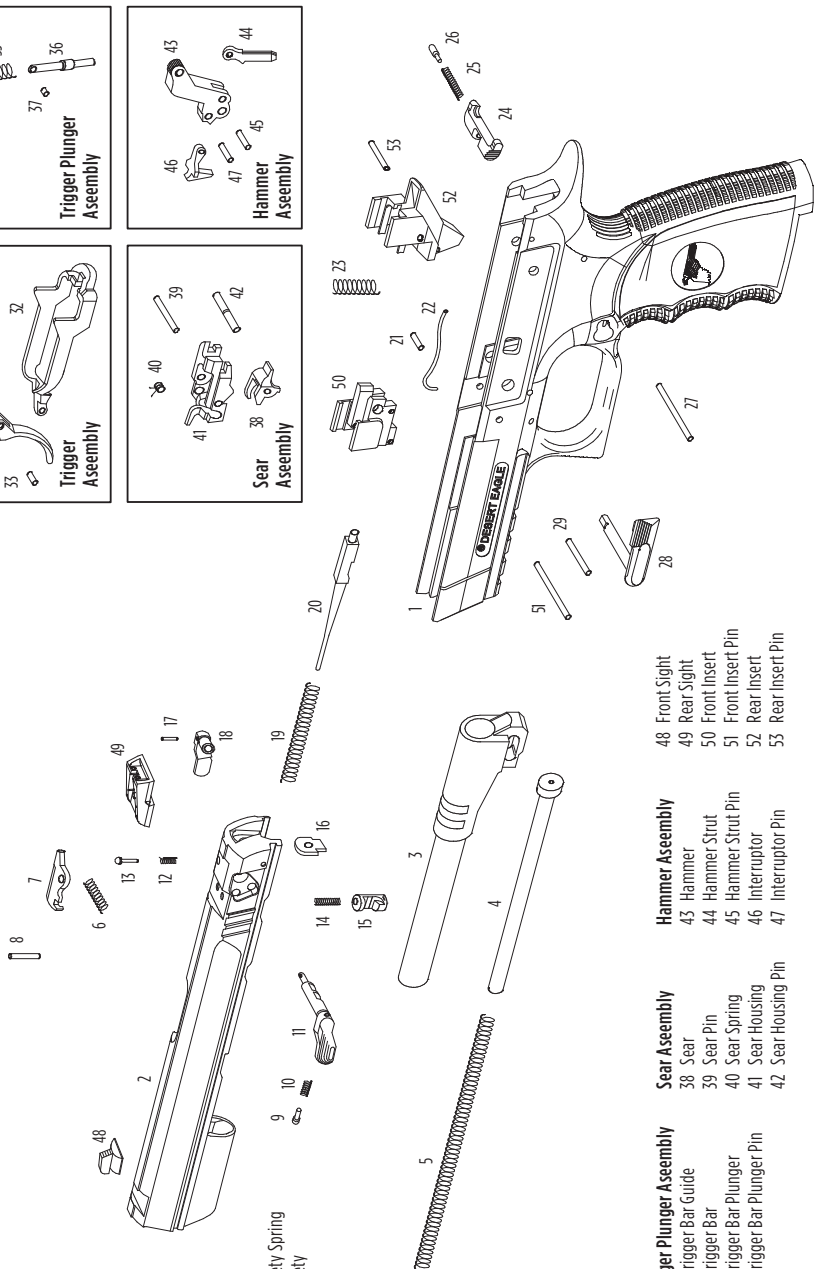

12. CONTACT & SHIPPING FOR SERVICE

For Owners within the United States:

MAGNUM RESEARCH, INC.®
12602 33rd Avenue SW, Pillager, MN 56473
Customer Service Department Phone: 218-746-3459 | Fax: 218-746-3097
E-mail: info@magnumresearch.com

- Call or e-mail the Customer Service Dept. for a return authorization number (RMA #) and shipping instructions.
- When returning a firearm for service, ensure that the firearm is unloaded.
- DO NOT SHIP ANY AMMUNITION IN THE SAME BOX WITH A FIREARM.
- Enclose a letter which includes your full name and address (no P.O. Boxes, please), daytime telephone number, e-mail address, the serial number of the pistol, and details of the problem experienced (stating the brand and type of ammunition used when the problem occurred) or work desired.
- Record the serial number before shipping, in case you wish to check on the repair status of your pistol.
- Please remove all custom parts and accessories, such as stocks, special sights, or holsters from your pistol before returning.
- Place the pistol in its original case or in a similarly secure container and pack securely.
- When returning a pistol, please include all magazines ensuring they are unloaded; they are important to the proper function of the pistol. You need to ensure that any loose magazines or other items are wrapped and packed well so that they do not rub against or contact the firearm or each other and cause damage during shipment. Magnum Research Inc is not responsible for damage caused by customers improper packing or shipping.
- The package must NOT bear any markings which indicate the identity of the contents.
- It is most important that you comply with federal, state, and local laws and regulations. The following guidelines are meant to help, but you must seek assistance from the appropriate authorities if necessary.
- Do not attempt to ship a firearm via US Postal Service; only federally licensed dealers may ship a firearm by US Postal Service.
- If your pistol must be replaced, it may be necessary to ship the replacement to a dealer rather than directly to you. You will be requested to furnish a signed FFL (Federal Firearms License) from your dealer in such an instance.
- Warranty repair work will begin upon receipt and examination of the pistol. If the repairs are not covered by warranty our professionally trained gunsmiths will repair the pistol and notify you of the charges. If the requested work will exceed \$100.00 they will notify you prior to starting the work. Repairs and modifications will begin upon receipt of payment.
- For a return authorization number please visit www.magnumresearch.com and click on the return authorization located on the home page under the Customer Service header.

LIMITED ONE-YEAR WARRANTY

Magnum Research, Inc.® firearms are warranted to be free from defects in material and workmanship. Any such defect of which Magnum Research, Inc.® is given written notice as provided below within one year and ten days from the date of first purchase by customer will be remedied by Magnum Research, Inc.® without notice.

This warranty is granted by Magnum Research, Inc.® to the original purchaser of a new Magnum Research firearm.

Warranty claims (in writing) and the firearm concerned should be directed (freight prepaid), to the Customer Service Department, Magnum Research, Inc.®, 12602 33rd Avenue SW, Pillager, MN 56473.

Warranty claim letters should state the model and serial number of the firearm concerned, a description of the difficulty experienced, the date of purchase, your name, billing address, a daytime phone number, and e-mail address. Remember to ship to Magnum Research, Inc.® freight prepaid. It is recommended to please use a delivery service able to track and/or insure your return item since Magnum Research, Inc.® will accept no responsibility for loss or damage in transit.

Transportation and insurance charges for return to the owner will be paid by Magnum Research, Inc.® if the related claim is a proper claim for warranty work.

Under no circumstances shall Magnum Research, Inc.® be responsible for incidental or consequential damages with respect to economic loss or injury to property, whether as a result of breach of express or implied warranty, negligence or otherwise. Some states do not allow the exclusion or limitation of incidental or consequential damages, so the above limitation may not apply to you. Magnum Research, Inc.® will not be responsible for result of careless handling, unauthorized adjustments, defective, low quality, reloaded or improper ammunition, corrosion, neglect, ordinary wear and tear, or unreasonable use. Furthermore, the liability of Magnum Research, Inc.® under this warranty shall be limited solely to the obligation to repair or replace the firearm and to pay the related transportation charge to the facility of Magnum Research, Inc.®

This warranty gives you specific legal rights, and you may also have other rights which vary from state to state.

PLEASE NOTE: Handguns and long guns are classified as FIREARMS or DANGEROUS WEAPONS. Firearms are sold by Magnum Research, Inc.® with the express understanding that it assumes no responsibility for re-sale handling under local laws and regulations.

WHAT IS NOT COVERED BY THIS WARRANTY?

- Failure to provide proper care and maintenance
- Use of Hand loaded, reloaded or improper ammunition
- Unauthorized adjustments, repairs or modifications
- Accidents, abuse or misuse
- Barrel obstruction
- Normal wear and tear



WARNING

ALL FIREARMS ARE DANGEROUS OBJECTS - PISTOLS INCLUDED.

ALWAYS CONSIDER THE PISTOL LOADED. TO RENDER IT SAFE, FIRST SET THE SAFETY ON THE “SAFE” POSITION OR DOWN POSITION. REMOVE THE MAGAZINE, THEN EJECT ANY REMAINING ROUND BY PULLING THE SLIDE TO THE REAR, AND ENSURING THE CHAMBER IS EMPTY. IT IS DANGEROUS TO ALTER OR MODIFY THIS FIREARM IN ANY WAY. ANY ALTERATIONS OR MODIFICATIONS OF THE FIRING MECHANISM MAY RESULT IN THIS FIREARM BECOMING UNSAFE, AND WILL NULLIFY ALL WARRANTIES.

USER IS ADVISED TO READ THE ENTIRE MANUAL PRIOR TO HANDLING THIS PISTOL AND OPERATING IT FOR THE FIRST TIME.

LIMITATION OF LIABILITY

The liability of BUL LTD. for any and all losses and/or damage to the purchaser shall in no event exceed the purchase price of pistol. In no event shall BUL LTD. be liable for incidental or consequential damage.

BUL LTD. reserves the right to make such alterations in design, dimensions, specifications and manufacture as are deemed necessary to ensure continued improvement.

FOR OTHER GREAT PRODUCTS AVAILABLE FROM MAGNUM RESEARCH AND KAHR FIREARMS GROUP

Visit us online at www.MagnumResearch.com, www.Kahr.com and www.Auto-Ordnance.com



Desert Eagle® Pistols

Build your own at: www.magnumresearchcustoms.com

Available in calibers: .50 AE, .44 Mag, .429 DE and .357 Mag

DESERT EAGLE

1911



Desert Eagle® 1911 Pistols

Available in calibers: .45 ACP and 10mm



BFR® Revolvers

Build your own at: www.magnumresearchcustoms.com

Available in a large variety of popular calibers



MagnumLite® Rimfire Rifles

Build your own at: www.magnumresearchcustoms.com

Available in caliber: .22LR

