

HI-POINT FIREARMS

MODEL C9 9MM
MODEL CF380 .380 ACP
MODEL CF380 COMP



TM

INSTRUCTION MANUAL

⚠WARNING Read this manual carefully
before loading or using your Hi-Point pistol.



TM

HI-POINT®

FIREARMS

Read this manual and the warnings contained in it before loading or using your Hi-Point pistol. This manual explains the function and the handling of your Hi-Point pistol and warns of the potential dangers, including death and serious personal injury, that can result from the unsafe use of your Hi-Point pistol. This manual should always accompany your Hi-Point pistol and be transferred with it if it is sold or loaned to another person.

Even if you are an experienced shooter, you must READ THIS ENTIRE MANUAL CAREFULLY before loading or firing your Hi-Point pistol. This manual gives basic instructions on the proper handling and functioning of your Hi-Point pistol. Your safety and the safety of others depends on you following the instructions and warnings in this manual and the constant use of safe firearms practices. If you are unfamiliar with firearms, take a course in the safe handling of firearms run by a qualified firearms instructor, your local gun club or a similar qualified organization.

This manual contains several safety warnings and instructions preceded with **▲WARNING**, **▲CAUTION** or **▲NOTICE**. These signal words are designed to draw your attention to important safety information. **▲WARNING** indicates a hazardous situation which, if not avoided, could result in death or serious personal injury. **▲CAUTION** indicates a hazardous situation, which, if not avoided, could result in moderate or minor personal injury. **▲NOTICE** indicates a hazardous situation which, if not avoided, could result in property damage.

▲WARNING Failure to follow the safety information and safety instructions in this manual could result in death or serious personal injury and/or property damage.

▲WARNING Always seek a doctor's advice if you are taking medication to be sure that you are able to shoot and handle a firearm safely. Never drink alcoholic beverages or take drugs before or while shooting. Your vision and judgment could be seriously impaired, making your firearm handling unsafe.

▲WARNING If your Hi-Point pistol or any other firearm is carelessly or improperly handled, you could cause a negligent discharge, which could result in death or serious personal injury and/or property damage.

▲WARNING Always handle your Hi-Point pistol as if it is loaded so that you never fire negligently.

▲WARNING Never point your Hi-Point pistol at anything you do not intend to shoot.

▲WARNING Never pull the trigger or put your finger on the trigger or in the trigger guard until you have made the decision to fire.

⚠WARNING Never take anyone's word that a firearm is unloaded; always check for yourself, with the firearm pointed in a safe direction and your finger off of the trigger and outside of the trigger guard.

⚠WARNING Always make sure your Hi-Point pistol is unloaded and that the slide is locked open in the rearward position with the magazine taken out before handing it to another person.

⚠WARNING Never alter or modify your Hi-Point pistol because this could cause it to malfunction and create a dangerous condition.

⚠WARNING If your Hi-Point pistol is dropped or forcefully struck, it could be damaged and may not function properly. Have it inspected by Strassell's Machine, Inc. before continuing to use it.

⚠WARNING Never carry or handle your Hi-Point pistol with a cartridge loaded in the chamber until you are ready to fire it.

⚠WARNING Always store and transport your Hi-Point pistol unloaded and locked in a suitable container, out of the reach and sight of children or other unauthorized persons.

⚠WARNING Never store or transport ammunition in the same container as your Hi-Point pistol.

⚠CAUTION Most ammunition contains lead in the projectile and/or primer. Firing your Hi-Point pistol in a poorly ventilated area can lead to the exposure to lead. Always wash your hands after handling ammunition, firing your Hi-Point pistol and/or performing preventive maintenance on your Hi-Point pistol to minimize your exposure to lead.

Before it left the factory, your Hi-Point pistol was tested, carefully inspected and packaged. Strassell's Machine, Inc. cannot control what happens to the pistol after it leaves the factory therefore, carefully examine your Hi-Point pistol when you acquire it to ensure that it is unloaded and undamaged. If you do not understand the warnings and instructions in this manual or have any problems operating your Hi-Point pistol, contact Strassell's Machine, Inc.'s customer service/warranty department at (419) 747-9444 and select option number two. If you need another copy of this manual, contact Strassell's Machine, Inc. at:

Strassell's Machine, Inc.
1015 Springmill Road
Mansfield, OH 44904
Telephone: (419) 747-9444

TABLE OF CONTENTS

Chapter 1 **Main Features of the Hi-Point Pistol**

Chapter 2 **Functioning of the Hi-Point Pistol**

Chapter 3 **Contents of the Hi-Point Pistol Box**

Chapter 4 **Loading**

Chapter 5 **Firing**

Chapter 6 **Clearing Malfunctions (Jams)**

Chapter 7 **Unloading**

Chapter 8 **Barrel Brushing**

Chapter 9 **Disassembly**

Chapter 10 **Complete Cleaning**

Chapter 11 **Assembly**

Chapter 12 **Function Testing**

Chapter 13 **Adjusting the Rear Sight**

Chapter 14 **Changing the Rear Sight**

Chapter 15 **Changing the Grips**

Chapter 16 **Use of the Dual Lok**

Chapter 17 **Storing the Hi-Point Pistol**

Chapter 18 **Parts List**

Chapter 19 **Technical Data**

Chapter 20 **Limited Lifetime Warranty**

Chapter 21 **Youth Handgun Safety Act Notice**

Chapter 22 **State Required Safety Warnings**



The Hi-Point Models C9, CF380 and CF380 COMP pistols are blowback operated, semi-automatic, striker fired pistols with an eight round detachable magazine. They are rated for safe use with +P ammunition. Some parts and operating elements are identified in the picture above.

Frame with Integrated Barrel

The frame is made from high impact polymer and includes an integrated barrel, which is made from high strength alloy steel. The frame also features a manually operated thumb safety, which can also be used to manually lock the slide rearward, and a magazine disconnect device, which blocks the trigger linkage and prevents the pistol from firing without a magazine inserted. The frame also incorporates an internal slide lock.

⚠WARNING Although your Hi-Point pistol has a magazine disconnect, it is a mechanical device, which could fail. Never rely on a magazine disconnect. Always fully retract and lock open the slide and then visually and physically (with your finger) check to make sure there is not a cartridge in the chamber.

Optional Ghost Ring Rear Sight Installed



MODEL
CF380

Grip Extension
on Magazine

Chamber
Observation
Port

- 3 1/2" Barrel
- Polymer frame
- Last round hold open
- Chamber observation port
- Push button mag release
- 8 shot standard magazine
- Adjustable 3 dot low profile sight
- Grip extension on magazine
- Magazine lock-out safety
- Manual Safety Lever

Slide and Chamber Observation Port

The slide is made from Zamak 3, a highly corrosion resistant alloy of zinc and aluminum. Depending on the version purchased, it has either a durable black powder coat finish or a hydro dipped camo finish. The barrel has a chamber observation port that allows you to visually observe the chamber without retracting the slide to confirm whether there is a cartridge in the chamber of the pistol.



⚠WARNING Although your Hi-Point pistol has a chamber observation port, you should never rely solely on the chamber observation port or your memory to determine whether your Hi-Point pistol is loaded or unloaded. Always remove the magazine, fully retract and lock open the slide and then visually and physically (with your finger) check to make sure there is not a cartridge in the chamber.



Thumb Safety/Manual Slide Lock

Your Hi-Point pistol has a manually operated thumb safety. The simple rotary design of the thumb safety blocks movement of the sear when it is engaged. To engage the thumb safety, push it fully upward with the thumb of your firing hand to place it in the on (safe) position, and reveal an "S" in a circle (Fig. 1). To disengage the thumb safety, push it fully downward with the thumb of your firing hand to place it in the off (fire) position and reveal a red dot (Fig. 2).



The thumb safety can also be used to manually lock the slide in the fully rearward position. To use the thumb safety as a slide lock, retract the slide fully to the rear, and then push the thumb safety fully upwards until it is in the notch on the slide (Fig. 3). If you have an empty magazine inserted in the pistol when retracting the slide fully to the rear, you may need to continue to retract it further rearward after the internal slide lock has engaged, in order to align the notch in the slide with the thumb safety/manual slide lock.



To release the slide using the thumb safety/manual slide lock, press it fully downwards with your thumb. (Note: If you have an empty magazine inserted in your Hi-Point pistol, you must remove it before pressing down on the thumb safety/manual slide lock to prevent the slide from being held in the rearward (open) position by the internal slide lock).

Passive Internal Drop Safeties

Your Hi-Point pistol includes two passive internal drop safeties that automatically function regardless of whether the thumb safety is in the on (safe) position. The first is a sear block, which consists of a spring loaded plate that falls under the sear pin arm to prevent the pistol from firing if dropped on its rear. The second is a counter weight, which is a weight that counteracts sear movement to prevent the pistol from firing if dropped on its handle (grip frame).

⚠WARNING Although your Hi-Point pistol has several internal design features and mechanical safeties designed to prevent an unintentional discharge if the pistol is dropped or hit, the proper and safe function of your Hi-Point pistol depends on it being used for its intended purposes and not being altered or modified. Like any other mechanical device, if your Hi-Point pistol is subjected to unusual and extreme forces, a part failure can occur. Therefore, safe firearm handling practices and the instructions and safety warnings in this manual must always be followed to minimize the risk of a negligent discharge.

⚠WARNING If your Hi-Point pistol's safeties prove to be ineffective for any reason, the possibility of an unintentional discharge exists. In this case, your Hi-Point pistol should be immediately unloaded and not be used again until it has been examined by Strassell's Machine, Inc.

Internal Slide Lock

Your Hi-Point pistol features an internal slide lock (hold open mechanism) that will automatically lock the slide in the fully rearward (open) position when the last round in the magazine is fired to signal that the magazine is empty. When the slide is pulled back with an empty magazine in place, it will also be held in the fully rearward position by the internal slide lock. To release the internal slide lock, pull the slide fully to the rear and release it without a magazine in the pistol, or with a loaded magazine inserted.

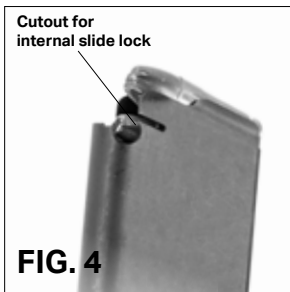

NOTICE Older Hi-Point magazines may not have the cutout for the internal slide lock. Do not force older magazines without the necessary cutout into the magazine well because this will damage the frame. (FIG 4)

Magazine Release

The magazine release button is located behind the trigger guard on the left side of the frame (opposite the ejection port). To remove the magazine, press the magazine release into the frame.

Sights

The front sight is integral to the slide and contains a colored or painted line for assistance with aiming. The rear sight is easily adjustable for both windage and elevation. It comes with an open sight installed and an additional ghost ring sight that can be easily changed by the user.

The following describes how your Hi-Point pistol functions when the magazine is inserted, a round is in the chamber and the thumb safety is fully downward in the off (fire) position.

When the trigger is pulled fully back, it releases the firing pin, which fires the cartridge in the chamber.

The recoil energy from the cartridge being fired causes the slide to move rearward and extract the fired cartridge casing from the chamber and eject it.

The recoil spring then brings the slide forward to the closed position, during which it strips the next cartridge from the magazine and transports it to the chamber.

When the trigger is released, your Hi-Point pistol is ready to be fired again, until the last cartridge in the magazine has been fired, after which the internal slide lock will lock the slide in the open (fully rearward) position.



**Hi-Point pistol
with magazine**



**Ghost ring rear
sight with Allen
wrench**

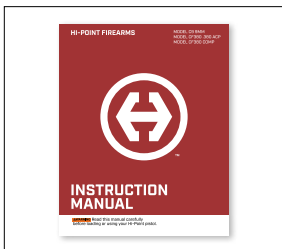

Instruction manual



**Yellow chamber
plug**



**Dual Lok / Trigger
lock with wrench /
adjustment tool**

NOTICE Not legal in California.



FIG. 1

⚠WARNING Use of improper ammunition could cause death or serious personal injury and/or property damage. Only use high quality commercially manufactured ammunition that meets SAAMI, CIP or NATO standards.

NOTICE Only use jacketed ammunition to prevent the buildup of lead deposits in the barrel.

To load the magazine, press each cartridge into the magazine from the front, with the cartridge bottom first, against the force of the magazine spring. (FIG. 1 & 2) A maximum of eight cartridges can be loaded into the magazine.



FIG. 2

Insert the loaded magazine into the magazine well until the magazine catch locks into place. (FIG. 3 & 4) To insert a cartridge from the magazine into the chamber, follow the appropriate procedure below.



FIG. 3

If the slide is in the forward position, hold your Hi-Point pistol with your firing hand and, while keeping your finger off the trigger and outside of the trigger guard, move the safety completely down to the fire position. Grasp the rear of the slide at the serrated area with your other hand and pull the slide fully back and then release it, allowing it to return to the fully forward position on its own. (FIG. 5 & 6)

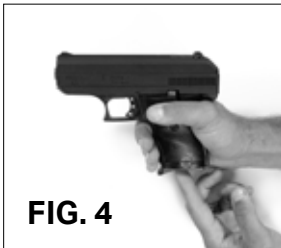

FIG. 4



FIG. 5



FIG. 6

Or

(1) If the slide is locked in the rearward position by the internal slide lock, grasp the rear of the slide at the serrated area with your other hand and pull the slide fully back and release it, allowing it to return to the fully forward position by itself.

(2) If the slide is locked in the rearward position by the thumb safety/manual slide lock, pull the slide back to release the pressure off the manual safety and with your thumb push the manual safety down to release the slide and let the slide return to the fully forward position by itself.

⚠WARNING Do not load a round into the chamber until you are ready to fire. You should never store, carry or handle a firearm with a cartridge in the chamber until you are ready to fire.

⚠WARNING Before firing your Hi-Point pistol, pull a clean patch through the barrel, from the chamber end, using a pull through cable/flexible cleaning rod. Repeat this procedure until the patch comes out of the barrel with no gun oil or cleaner-lubricant-preservative on it because any obstruction in the barrel could prevent your Hi-Point pistol from firing properly and result in death or serious personal injury and/or damage to your Hi-Point pistol.

⚠WARNING Always be sure that the barrel of your Hi-Point pistol is clear of obstructions before firing it. Remove any obstructions before firing your Hi-Point pistol so that it will function safely and correctly. Any obstruction in the barrel could prevent the pistol from firing properly and result in death or serious personal injury and/or damage to your Hi-Point pistol.

⚠WARNING In case of a failure to fire, continue to hold your Hi-Point pistol pointed towards the target or in a safe direction for at least 30 seconds. If a hangfire (slow ignition) has occurred, the cartridge should fire within approximately 30 seconds. If the cartridge has not fired within 30 seconds, remove the magazine with your Hi-Point pistol still pointed in a safe direction and the ejection port facing away from you, pull the slide fully to the rear to eject the cartridge from the chamber and examine its primer. If the firing pin indentation is light or nonexistent, stop using your Hi-Point pistol and have it examined by a qualified gunsmith or Strassell's Machine, Inc. If the firing pin indentation on the primer appears normal (compared to similar previously fired cartridges), the cartridge may be defective. Separate the cartridge from other live ammunition and empty cases, reload your Hi-Point pistol and resume firing. (Note: Dispose of misfired cartridges in accordance with the ammunition manufacturer's instructions.)

⚠WARNING Never use your Hi-Point pistol if it fails to function properly, and never force the slide closed on a jammed cartridge because it could cause the cartridge to explode.

⚠WARNING Never pull the trigger if the slide does not fully close to prevent a possible out of battery firing. If the slide does not fully close, unload your Hi-Point pistol as described in Chapter 7, examine the round that was in the chamber, and check the chamber to ensure that there are no obstructions or debris in it.

⚠WARNING Always wear safety glasses when firing your Hi-Point pistol, to protect your eyes, and make sure that anyone nearby is also wearing safety glasses to protect their eyes.

⚠WARNING Always wear ear protection when firing your Hi-Point pistol, to protect your hearing, and make sure that anyone nearby is also wearing ear protection to protect their hearing.

⚠WARNING Always be sure that your backstop is adequate to stop and contain bullets before firing so that you do not hit anything outside of the shooting range area. A bullet could travel through or past your target as far as 1.5 miles. If in doubt, do not shoot.

⚠WARNING Never shoot at a hard surface, such as a rock, or a liquid surface, such as water, because a bullet could ricochet and travel in any direction, striking you or someone else.

⚠WARNING Always put a responsible and competent person in charge to maintain safety, discipline and control when a group is firing at a range, to reduce the likelihood of a negligent discharge.

⚠WARNING Always carry your Hi-Point pistol unloaded with the slide locked open in the rearward position while on a range until preparing to fire. Always keep your Hi-Point pistol pointed towards the backstop when loading, firing and unloading it.

⚠CAUTION When ready to fire, be sure that the area behind the slide is clear (check your thumb) and do not hold your Hi-Point pistol near your body, because the slide will move forcefully rearward when the pistol is fired. (Note: When firing with a two-hand grip, the thumb of the weak hand should be on the weak hand side of your Hi-Point pistol, never behind the slide.)

⚠CAUTION Always keep yourself and others clear of the ejection port because spent cartridges are hot and are ejected with enough force to cause injury. Never touch the slide or barrel immediately after firing because they may be hot and could cause burns.

⚠CAUTION Never place your fingers in the ejection port because they could be injured by the movement of the slide.

⚠CAUTION Never fire your Hi-Point pistol near an animal unless it is trained to accept that noise. An animal's startled reaction could injure it or cause it to injure you or someone else.



FIG. 1

When a cartridge is loaded in the chamber and the magazine is correctly inserted, your Hi-Point pistol can be fired by completing the following steps.

- 1. Hold your Hi-Point pistol with your firing hand and support it with your other hand.**
- 2. Aim at the target.**
- 3. Push the thumb safety fully downward to the off (fire) position.**
- 4. Place your index finger on the trigger and pull it to its rearmost position and then release it.**

After firing the last cartridge in the magazine, the slide will remain locked open in the rearward position to signal that the magazine is empty. (Note: Your Hi-Point pistol has a magazine disconnect, therefore a magazine has to be properly locked into the frame for it to fire.) (FIG.1)

⚠WARNING In case of a failure to fire, continue to hold your Hi-Point pistol pointed towards the target for at least 30 seconds. If a hangfire (slow ignition) has occurred, the cartridge should fire within approximately 30 seconds. If the cartridge has not fired within 30 seconds, remove the magazine with your Hi-Point pistol still pointed in a safe direction and the ejection port facing away from you, pull the slide fully to the rear to eject the cartridge from the chamber and examine its primer. If the firing pin indentation is light or nonexistent, stop using your Hi-Point pistol and have it examined by a qualified gunsmith or Strassell's Machine, Inc. If the firing pin indentation on the primer appears normal (compared to similar previously fired cartridges), the cartridge may be defective. Separate the cartridge from other live ammunition and empty cases, reload your Hi-Point pistol and resume firing. (Note: Dispose of misfired cartridges in accordance with the ammunition manufacturer's instructions.)

⚠WARNING If an unfired cartridge hangs up, jams or binds while being chambered, do not attempt to force it into the chamber by pushing or striking the slide to attempt to close it because this could cause the cartridge to burst, resulting in fragments of the cartridge flying out of the ejection port with sufficient force to cause death or serious personal injury and/or property damage.

⚠WARNING Always wear safety glasses when attempting to remove a jammed cartridge, to protect your eyes.

All auto-loading pistols may occasionally experience a malfunction (jam) related to the feeding of ammunition. Most malfunctions are caused by improper ammunition, improper lubrication or a damaged magazine. To minimize the chance of malfunctions (jams), regularly clean your Hi-Point pistol following the instructions in Chapters 8 and 10 of this manual. If you experience a malfunction (jam) while using a new brand, type or lot of ammunition, try firing another type of ammunition to determine whether the ammunition was the source of the malfunction (jam).

⚠WARNING Use of improper ammunition could cause death or serious personal injury and/or property damage. Only use high quality commercially manufactured ammunition that meets SAAMI, CIP or NATO standards.

If a cartridge becomes jammed while being chambered or extracted, follow the steps below to remove it.

1. While keeping the muzzle of your Hi-Point pistol pointed in a safe direction (a safe direction is one in which no one can possibly be injured in the event of an unintentional discharge), remove the magazine if possible by pressing the magazine release.

2. While holding the grip with your firing hand, with your finger off of the trigger and outside of the trigger guard, grasp the rear of the slide at the serrated area with your other hand and pull the slide fully back.



3. Lock the slide in the rearward (open) position by pushing the thumb safety/manual slide lock up into the notch on the slide and slowly releasing the slide from the fully rearward position until it locks in the open position. (FIG. 1)

4. If the above steps have not released the jammed cartridge, carefully remove the jammed cartridge from the chamber using your fingers or a pointed wooden dowel.

⚠WARNING Do not use a metal tool to attempt to remove an unfired cartridge because it could ignite the primer and cause the cartridge to rupture, resulting in fragments of the cartridge flying out of the ejection port with sufficient force to cause death or serious personal injury and/or property damage.

⚠WARNING Never force anything down the barrel of the pistol to dislodge a live round.

5. If you are unable to remove the jammed cartridge using the above steps, leave the slide locked in the rearward (open) position and contact a qualified gunsmith or Strassell's Machine, Inc. for further instructions.

⚠WARNING Although your Hi-Point pistol has a chamber observation port, you should never rely solely on the chamber observation port or your memory to determine whether your Hi-Point pistol is loaded or unloaded. Always remove the magazine, fully retract and lock open the slide and then visually and physically (with your finger) check to make sure there is not a cartridge in the chamber.

⚠WARNING Although your Hi-Point pistol has a magazine disconnect, it is a mechanical device, which could fail. Never rely on a magazine disconnect and always fully retract and lock open the slide, and then visually and physically (with your finger) check to make sure there is not a cartridge in the chamber.

⚠WARNING Never rely on the last round hold open to determine the pistol is unloaded.

To unload your Hi-Point pistol, follow the instructions below. To ensure that your Hi-Point pistol is unloaded, you **MUST** proceed in this order.



1. Remove the magazine by depressing the magazine release button. (FIG. 1)



2. Push the thumb safety fully downward to the off (fire) position. Note: The thumb safety must be in the off (fire) position to allow the slide to be retracted. (FIG. 2)



3. Ensure the ejection port is facing away from you and the pistol is pointed in a safe direction (a safe direction is one in which no one can possibly be injured in the event of an unintentional discharge). While holding the grip with your firing hand and with your finger off of the trigger and outside of the trigger guard, grasp the rear of the slide at the serrated area with your other hand and pull the slide fully back to eject any cartridge that may be in the chamber. (FIG. 3)

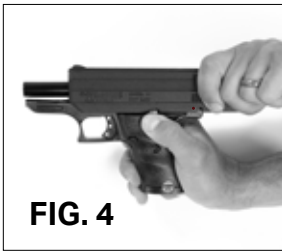

4. Lock the slide in the rearward (open) position by pushing the thumb safety/manual slide lock up into the notch on the slide and slowly releasing the slide from the fully rearward position until it locks in the open position. (FIG. 4)

5. Once the slide is locked to the rear, visually and physically (with your finger) inspect the chamber and the magazine well of your Hi-Point pistol to be sure that no ammunition remains in either place. (FIG.5)



6. Release the slide to return it to the forward (closed) position by depressing the thumb safety/manual slidelock down.

⚠WARNING Always be sure that the barrel of your Hi-Point pistol is clear of obstructions before firing it. Remove any obstructions before firing your Hi-Point pistol so that it will function safely and correctly. Any obstruction in the barrel could prevent the pistol from firing properly and result in death or serious personal injury and/or damage to your Hi-Point pistol.

⚠WARNING Although your Hi-Point pistol has a magazine disconnect, it is a mechanical device, which could fail. Never rely on a magazine disconnect and always fully retract and lock open the slide, and then visually and physically (with your finger) check to make sure there is not a cartridge in the chamber.

⚠WARNING Always wear safety glasses when cleaning your Hi-Point pistol, to protect your eyes from cleaning materials.

⚠WARNING Always make sure that no ammunition is located in the area where you clean your Hi-Point pistol. Cleaning solvents can affect the primer and powder in ammunition and cause it to malfunction. This could result in a bullet being pushed into the barrel of your Hi-Point pistol and getting stuck. Firing another round with a bullet stuck in the barrel could cause the barrel to burst and result in death or serious personal injury and/or damage to your Hi-Point pistol.

NOTICE As with any semi-automatic pistol, your Hi-Point pistol should be cleaned from the breach. Cleaning with the slide locked to the rear by inserting a rigid cleaning rod from the muzzle can cause dirt, oil and solvents to build up inside your Hi-Point pistol, causing malfunctions.

NOTICE Only use commercially available gun solvent and gun oil or a cleaner-lubricant-preservative. Use of improper cleaning fluids could damage your Hi-Point pistol.

You should brush the barrel of your Hi-Point pistol after firing every 300 to 400 rounds.

To brush the barrel of your unloaded Hi-Point pistol, follow the instructions below.

1. Remove the magazine by depressing on the magazine release.
2. Push the thumb safety fully downward to the off (fire) position. (Note: The thumb safety must be in the off (fire) position to allow the slide to be retracted.)
3. While holding the grip with your firing hand and with your finger off of the trigger and outside of the trigger guard, grasp the rear of the slide at the serrated area with your other hand and pull the slide fully back to eject any cartridge that may be in the chamber.

4. Lock the slide in the rearward (open) position by pushing the thumb safety/manual slide lock up into the notch on the slide and slowly releasing the slide from the fully rearward position until it locks in the open position.
5. Once the slide is locked to the rear, visually and physically (with your finger) inspect the chamber and the magazine well of your Hi-Point pistol to be sure that no ammunition remains in either place.
6. Wet a cleaning patch with a gun cleaning solvent or a cleaner-lubricant-preservative and pull it through the barrel, from the chamber end, several times using a pull through cable/flexible cleaning rod.
7. Wet a bristled cleaning brush with gun cleaning solvent or a cleaner-lubricant-preservative and pull it through the barrel, from the chamber end, several times using a pull through cable/flexible cleaning rod.
8. Wet a new cleaning patch with gun oil or a cleaner-lubricant-preservative and pull it through the barrel once, from the chamber end, with the pull through cable/flexible cleaning rod and examine it. If it is not clean, repeat steps 6-8 until the patch remains clean after being pulled through the barrel.
9. Before firing your Hi-Point pistol, pull a clean patch through the barrel, from the chamber end, using the pull through cable/flexible cleaning rod. Repeat this procedure until the patch comes out of the barrel with no gun oil or cleaner-lubricant-preservative on it. (Note: If you will be storing your Hi-Point pistol, do not perform step 9 until you are ready to use it.)

⚠WARNING Unload all magazines and remove all live ammunition from the area before disassembling your Hi-Point pistol to reduce the chance of a negligent discharge.

⚠WARNING Although your Hi-Point pistol has a chamber observation port, you should never rely solely on the chamber observation port or your memory to determine whether your Hi-Point pistol is loaded or unloaded. Always remove the magazine, fully retract and lock open the slide and then visually and physically (with your finger) check to make sure there is not a cartridge in the chamber.

⚠WARNING Although your Hi-Point pistol has a magazine disconnect, it is a mechanical device, which could fail. Never rely on a magazine disconnect and always retract the slide by grasping it at the serrated area at the rear of the slide and pulling it fully to the rear, and then visually and physically (with your finger) check to make sure there is not a cartridge in the chamber.

⚠WARNING Never alter or modify your Hi-Point pistol because this could cause it to malfunction and create a dangerous condition.

⚠WARNING Always wear safety glasses when disassembling your Hi-Point pistol, to protect your eyes from components that are under pressure, such as springs, and the sear assembly that could fly out and hit you.

To disassemble (field strip) your Hi-Point pistol for cleaning, follow the instructions below. To ensure that your Hi-Point pistol is unloaded, disassembly **MUST** be performed in this order.



FIG. 1

1. Remove the magazine by depressing the magazine release button. (FIG. 1)

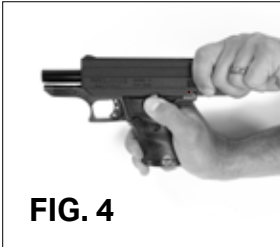

FIG. 2

2. Push the thumb safety fully downward to the off (fire) position. (Note: The thumb safety must be in the off (fire) position to allow the slide to retract.) (FIG. 2)



3. While holding the grip with your firing hand, with your finger off of the trigger and outside of the trigger guard, grasp the rear of the slide at the serrated area with your other hand and pull the slide fully back to eject any cartridge that may be in the chamber. (FIG. 3)



4. Lock the slide in the rearward (open) position by pushing the thumb safety/manual slide lock up into the notch on the slide and slowly releasing the slide from the fully rearward position until it locks in the open position. (FIG. 4)



5. Once the slide is locked to the rear, visually and physically (with your finger) inspect the chamber and the magazine well of your Hi-Point pistol to be sure that no ammunition remains in either place. (FIG. 5)

6. While the thumb safety/manual slide lock remains pushed up into the notch of the slide, the slide retainer pin at the rear of the frame will be exposed. Use a 1/8" pin punch and a small hammer to remove the slide retainer pin from the frame by pushing it fully through and out of the frame. (FIG. 6 & 6.1)

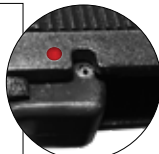



7. After the slide retainer pin has been fully removed from the frame, release the slide to return it to the forward (closed) position by pressing the thumb safety/manual slide lock down. (FIG. 7)



8. Insert an empty magazine into the magazine well to deactivate the magazine disconnect device and, with the muzzle of your Hi-Point pistol pointed in a safe direction (a safe direction is one in which no one can possibly be injured in the event of an unintentional discharge), pull the trigger to release the striker. (Note: Although it is possible to disassemble your Hi-Point pistol with the striker cocked, it is much easier to remove the slide with the striker released.) (FIG. 8)

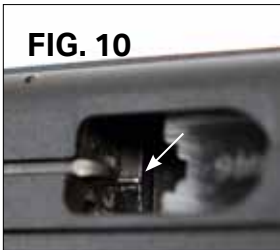

9. Remove the magazine by pressing down on the magazine release.

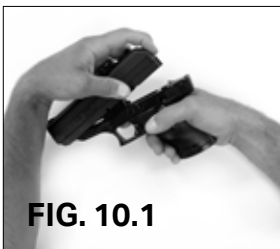

10. While holding a finger over the rear of the slide pull the slide approximately 3/8" to the rear and then pull the rear of the slide up and push it forward to remove the slide assembly from the frame.

NOTICE You must pull the slide approximately 3/8" to the rear to retract the firing pin from the chamber before pulling up on the slide. The firing pin extends beyond the breach face and can be damaged if the slide is pulled up before it is retracted. (FIG.10 & 10.1)

⚠CAUTION Do not pull trigger with the slide removed. Sear is under spring tension and could fly out.

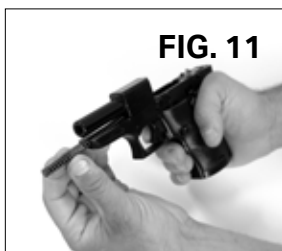

11. Pull the recoil spring and recoil spring guide rod forward and out of the frame. (FIG. 11)



12. Pull the slide retainer out the back of the slide. (FIG. 12)



13. Turn the slide upside down and allow the firing pin spring, firing pin spring assist and the firing pin to slide out the back of the slide. (Note: Be careful not to shake or invert the frame because components are now exposed and can simply fall out). (FIG. 13)

⚠WARNING Never disassemble your Hi-Point pistol further than this procedure. Any further disassembly by untrained persons could cause your Hi-Point pistol to malfunction and will void the warranty.

Removing the Compensator for Disassembly Model CF380 COMP

WARNING Make sure that your Hi-Point pistol is unloaded (magazine removed and chamber empty) before removing the compensator. Refer to Chapter 7 "Unloading" before removing the compensator.



1. Using a 9/64" hex key, remove the compensator screw and nut. (FIG.1 & FIG.1.1)



2. With a back and forth twisting motion, remove the compensator from the barrel. (FIG. 2)

⚠WARNING Always be sure that the barrel of your Hi-Point pistol is clear of obstructions before firing it. Remove any obstructions before firing your Hi-Point pistol so that it will function safely and correctly. Any obstruction in the barrel could prevent the pistol from firing properly and result in death or serious personal injury and/or damage to your Hi-Point pistol.

⚠WARNING Although your Hi-Point pistol has a magazine disconnect, it is a mechanical device, that could fail. Never rely on a magazine disconnect and always fully retract and lock open the slide and then visually and physically (with your finger) check to make sure there is not a cartridge in the chamber.

⚠WARNING Always wear safety glasses when cleaning your Hi-Point pistol, to protect your eyes from cleaning materials.

⚠WARNING Always make sure that no ammunition is located in the area where you clean your Hi-Point pistol. Cleaning solvents can affect the primer and powder in ammunition and cause it to malfunction. This could result in a bullet being pushed into the barrel of your Hi-Point pistol and getting stuck. Firing another round with a bullet stuck in the barrel could cause the barrel to burst and result in death or serious personal injury and/or damage to your Hi-Point pistol.

NOTICE Only use commercially available gun solvent and gun oil or a cleaner-lubricant-preservative. Use of improper cleaning fluids could damage your Hi-Point pistol.

Regular cleaning and care of your Hi-Point pistol is important to prolong its service life by reducing wear and helping to ensure its functional safety.

You should completely clean your Hi-Point pistol after firing every 1,500 to 2,000 rounds or anytime it is exposed to the elements, becomes wet, etc.

To completely clean your unloaded Hi-Point pistol, first disassemble it following the instructions in Chapter 9 and then clean it according to the instructions below.

BARREL: Clean the barrel as follows:

1. Wet a cleaning patch with a gun cleaning solvent or a cleaner-lubricant-preservative and run it through the barrel, from the chamber end, several times using a cleaning rod.

2. Wet a bristled cleaning brush with gun cleaning solvent or a cleaner-lubricant-preservative and run it back and forth in the barrel, from the chamber end, using a cleaning rod.
3. Wet a new cleaning patch with gun oil or a cleaner-lubricant-preservative and run it through the barrel once, from the chamber end, with the cleaning rod and examine it. If it is not clean, repeat steps 2 and 3 until the patch remains clean after being run through the barrel.
4. Before firing your Hi-Point pistol, run a clean patch through the barrel, from the chamber end, using the cleaning rod. Repeat this procedure until the patch comes out of the barrel with no gun oil or cleaner-lubricant-preservative on it. (Note: If you will be storing your Hi-Point pistol, do not perform step 4 until you are ready to use it).
5. Wet a nylon bristle brush with gun cleaning solvent or a cleaner-lubricant-preservative and thoroughly brush the outside of the barrel to remove any dirt or residue.
6. Wipe the outside of the barrel dry with a clean patch and examine it. If it is not clean, repeat steps 5 and 6 until the patch remains clean.

SLIDE: Clean the slide as follows:

NOTICE Do not use solvents on hydrodipped coated surfaces.

1. Wet a nylon bristle brush with gun cleaning solvent or a cleaner-lubricant-preservative and thoroughly brush the bottom surfaces where the slide sits on the frame.
2. Wipe the bottom surfaces where the slide sits on the frame with a clean patch and examine it. If it is not clean, repeat steps 1 and 2 until the patch remains clean.
3. Wet a nylon bristle brush with gun oil or a cleaner-lubricant-preservative and, while holding the slide with the muzzle end facing down, brush the breech face and the area under the extractor.

4. While holding the slide with the muzzle end facing down, wipe the breech face with a clean patch and examine it. If it is not clean, repeat steps 3 and 4 until the patch remains clean.
5. Check all other exposed areas of the slide for cleanliness. If any dirt or debris is found, remove it with gun cleaning solvent or a cleaner-lubricant-preservative using a nylon bristle brush or a clean patch.
6. Wipe the exposed areas of the slide that you have cleaned in step 5 with a clean patch and examine it. If it is not clean, repeat steps 5 and 6 until the patch remains clean.

FRAME: Check the frame for cleanliness. If necessary, clean the frame as follows:

1. Wipe exposed parts of the frame with a clean patch that has been slightly dampened with gun cleaning solvent or a cleaner-lubricant-preservative.
2. Wipe the exposed areas of the frame with a clean patch and examine it. If it is not clean, repeat steps 1 and 2 until the patch remains clean.

MAGAZINE: Inspect the magazine for dirt or visible damage. If necessary, clean the magazine as follows:

1. Wipe the outside of the magazine and the feed lips with a clean patch that has been slightly dampened with gun cleaning solvent or a cleaner-lubricant-preservative.
2. Wipe the outside of the magazine and the feed lips with a clean patch and examine it. If it is not clean, repeat steps 1 and 2 until the patch remains clean.

After you have cleaned your Hi-Point pistol, lubricate it by slightly dampening a clean patch with gun oil or a cleaner-lubricant-preservative and wiping the outside of the barrel, the inside of the slide and the outside of the magazine.

⚠CAUTION Your Hi-Point pistol is designed to operate properly with only a small amount of lubrication. Do not over lubricate your Hi-Point pistol because too much lubricant can collect unburned powder and other debris and prevent your Hi-Point pistol from functioning properly.

After you have finished cleaning and lubricating your Hi-Point pistol, and before you assemble it, you should inspect the barrel for lead build up, bulges, cracks or obstructions and inspect the frame and slide for any corrosion or any visible damage.

⚠WARNING Do not use a cracked, bulged or obstructed barrel. Contact Strassell's Machine, Inc. for instructions on having it replaced.

Check the magazine to make sure the follower and lips are not damaged. Press down on the follower with your fingertip and release it to make sure it springs back up and does not catch in the magazine tube.

Always wear safety glasses when reassembling your Hi-Point pistol, to protect your eyes from components that are under pressure, such as springs.

To assemble your unloaded Hi-Point pistol, follow the instructions below.



1. Install the firing pin into the slide by holding the slide with the muzzle facing down and sliding the firing pin down and into the channel in the rear of the slide. (FIG. 1)



2. Install the firing pin spring and firing pin assist spring into the slide by holding the slide with the muzzle facing down and sliding the firing pin spring and firing pin assist spring down and into the channel in the rear of the slide. (FIG. 2)



3. Install the slide retainer into the slide by holding the cylindrical part and inserting the rounded part into the channel at the rear of the slide. (FIG. 3)

FIG. 4

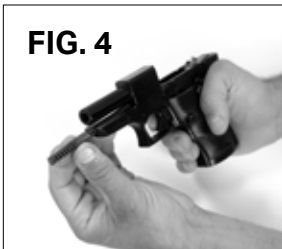

4. Install the recoil spring and recoil spring guide rod into the frame by pushing them into the cylindrical area of the frame below the barrel with guide rod facing forward. (FIG. 4)

FIG. 5



5. While holding the frame in your firing hand with your finger off of the trigger and outside of the trigger guard, hold the slide with your other hand, with your index finger covering the opening at the channel of the rear of the slide to hold the slide retainer in place. Place the slide on top of the frame with the recoil spring and recoil spring guide rod aligned with the tab at the front of the slide below the opening for the barrel. (FIG. 5)

FIG. 6



6. Pull the slide back toward the rear of the frame until the slide retainer is aligned with the hole at the rear of the frame (FIG. 6) and slide it back enough to clear the firing pin from hitting the barrel if it is protruding from the breach face. Then push the slide down to lock it back in place. (Note: If necessary, use the index finger of your firing hand to guide the slide retainer down and into the hole in the rear of the frame.)



7. While continuing to hold the frame in your firing hand with your finger off of the trigger and outside of the trigger guard, grasp the top of the slide with your other hand and pull the slide fully back to the rearward position. (FIG. 7)



8. While continuing to hold the slide in the fully rearward position, push the thumb safety/manual slide lock up into the notch on the slide and slowly release the slide from the fully rearward position until it locks in the open position.

9. Once the slide is locked to the rear, align the slide retainer pin with the notches on the slide and insert it fully through the frame using a 1/8" pin punch and a hammer so that it is fully flush with the frame and does not protrude from either side. (FIG. 8)

10. Press the thumb safety/slide lock fully downward to release the slide and return it to the forward (closed) position.

⚠WARNING Always make sure that the slide retaining pin is properly reinstalled when assembling your Hi-Point pistol. If it is not correctly installed, your Hi-Point pistol will still fire, but the slide will not be properly locked in place which could lead to serious personal injury, and/or damage to your Hi-Point pistol.

Reinstalling the Compensator Model CF380 COMP

Note: Your Hi-Point pistol must be fully assembled before reinstalling the compensator.



FIG. 1

1. With a back and forth twisting motion, slide the compensator over the barrel and carefully align the compensator screw hole with the barrel groove. (FIG. 1 & 1.1)



FIG. 1.1



FIG. 2

2. Using 9/64" hex key, insert the compensator screw and nut and securely tighten them. (FIG. 2)

NOTICE Retighten the compensator screw after firing 10-20 rounds and check it periodically to ensure that it remains securely tightened.

⚠WARNING Make sure that your Hi-Point pistol is unloaded (both the chamber and the magazine are empty) before performing a function check.

After assembling your Hi-Point pistol or remedying a malfunction, you should perform a function test to ensure that it is operating correctly by completing the following steps:

1. Insert an unloaded magazine into the magazine well, and make sure that it noticeably locks into place.
2. With the thumb safety fully down in the off (fire) position, pull the slide back as far as it will go and release it to make sure that it is held in the open position by the internal slide lock.
3. Press the magazine release and make sure that the magazine can be easily removed from the magazine well. Leave the magazine out of the pistol.
4. While holding the frame in your firing hand, grasp the rear of the slide at the serrated area with your other hand, pull the slide fully back and then release it to ensure that it returns to the fully forward position.

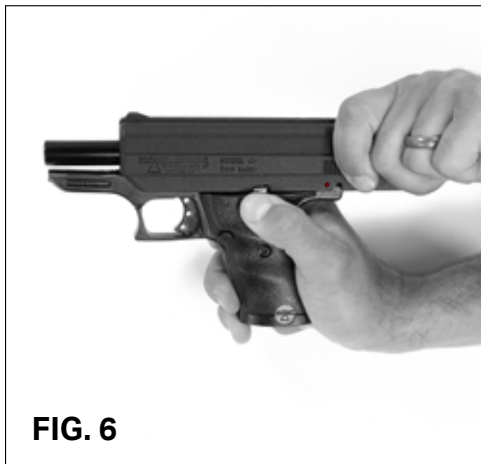

FIG. 6

5. With your finger off of the trigger and outside of the trigger guard, retract and release the slide several times to make sure it moves freely.
6. While holding the frame in your firing hand, grasp the top of the slide with your other hand and pull the slide fully back. While holding the slide in the fully rearward position, use the thumb of your firing hand to push the thumb safety/manual slide lock fully upward into the slide lock notch of the slide. (FIG. 6)
7. Press the thumb safety/manual slide lock fully downward to ensure that the slide is released and returns to the forward (closed) position.

- 8.** With the thumb safety fully down in the off (fire) position and the muzzle of your Hi-Point pistol pointed in a safe direction (a safe direction is one in which no one can possibly be injured in the event of an unintentional discharge), attempt to pull the trigger to ensure that the magazine disconnect prevents the striker from being released.
- 9.** Move the thumb safety fully upward to the on (safe) position and, with the muzzle of your Hi-Point pistol pointed in a safe direction (a safe direction is one in which no one can possibly be injured in the event of an unintentional discharge), attempt to pull the trigger to ensure that the striker is not released.
- 10.** Insert an unloaded magazine into the magazine well and make sure that it noticeably locks into place.
- 11.** With the thumb safety fully upward in the on (safe) position and the muzzle of your Hi-Point pistol pointed in a safe direction (a safe direction is one in which no one can possibly be injured in the event of an unintentional discharge), attempt to pull the trigger to ensure that the striker is not released.
- 12.** Move the thumb safety fully down to the off (fire) position and, with the muzzle of your Hi-Point pistol pointed in a safe direction (a safe direction is one in which no one can possibly be injured in the event of an unintentional discharge), pull the trigger to ensure that the striker is released.

FIG. 1



⚠WARNING Make sure that your Hi-Point pistol is unloaded (magazine removed and chamber empty) before adjusting the rear sight. Use of the provided yellow chamber plug is recommended to ensure the pistol is unloaded

To adjust the rear sight on your unloaded (magazine removed and chamber empty) Hi-Point pistol, follow the procedure below. (Note: You do not need to remove the slide to adjust the sights.)

To adjust the point of impact horizontally (right or left), use the dual lok wrench/adjustment tool or a small flat screwdriver to turn the windage screw. To move the point of impact to the right, turn the windage screw clockwise. To move the point of impact to the left, turn the windage screw counterclockwise. (FIG. 1)

To adjust the point of impact vertically (up or down), use the dual lok wrench/adjustment tool or a small flat screwdriver to turn the elevation screw. To move the point of impact higher, turn the elevation screw counterclockwise. To move the point of impact lower, turn the elevation screw clockwise. (FIG. 2)

FIG. 2

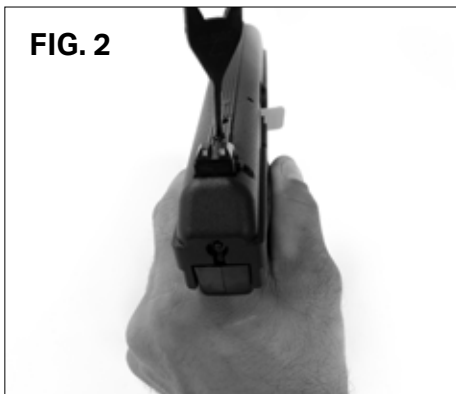

⚠WARNING Make sure that your Hi-Point pistol is unloaded (magazine removed and chamber empty) before changing the rear sight. Use of the provided yellow chamber plug is recommended to ensure the pistol is unloaded

⚠WARNING Always wear safety glasses when changing the rear sight on your Hi-Point pistol, to protect your eyes from components that are under pressure, such as springs.

Your Hi-Point pistol comes with two different rear sights that can be simply changed based on your preference. (Note: You do not need to remove the slide to change the sights.) An open sight comes installed on the pistol, and an optional ghost ring sight is provided. To change between the open sight and ghost ring rear sight, follow the procedure below. (Note: The adjustable rear sight assembly holds the adjustable sight spring in place and will be pushed up and away from the slide as the elevation screw and sight pivot retainer screws are unscrewed.)



1. Use the included Allen wrench to remove the sight pivot retainer screw by turning it counterclockwise. (FIG. 1)

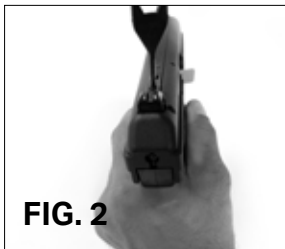

2. Use the dual lok wrench/adjustment tool or a small flat screw driver to remove the elevation screw by turning it counterclockwise. (FIG. 2)



3. Carefully lift the adjustable rear sight assembly up and away from the slide. (FIG. 3)

4. Pull the adjustable sight spring up and away from the slide, and secure it in a safe place where it will not be lost.



5. To remove the rear sight from the adjustable rear sight assembly, use the dual lock wrench/adjustment tool or a small flat screwdriver to turn the windage screw counterclockwise until the sight can be easily pulled off of the left side of the adjustable rear sight assembly with your fingers. (FIG. 5)



6. Align the round opening on the bottom of the new rear sight against the opening on the left side of the adjustable rear sight assembly and push it against the windage screw. Turn the windage screw clockwise with the dual lock wrench/adjustment tool or a small flat screwdriver until the new sight is centered in the adjustable rear sight assembly. (FIG. 6)

FIG. 7



7. Place the adjustable sight spring into the round hole at the top of the slide. (FIG. 7)
8. Place the adjustable rear sight assembly into the cutout at the top of the slide and push it down against the adjustable sight spring and hold it down in place with your finger.
9. While continuing to hold the adjustable rear sight assembly down in place with your finger, install the sight pivot screw by turning it clockwise with the included Allen wrench.
10. While continuing to hold the adjustable rear sight assembly down in place with your finger, install the elevation screw by turning it clockwise with the dual lok wrench/adjustment tool or a small flat screwdriver. (Note: After changing the rear sight, you may have to adjust it following the instructions in Chapter 13.)

⚠WARNING Make sure that your Hi-Point pistol is unloaded (magazine removed and chamber empty) before changing the grips. Use of the provided yellow chamber plug is recommended to ensure the pistol is unloaded.

NOTICE Do not overtighten the grip screws because this could damage the polymer frame.

Your Hi-Point pistol comes with high impact plastic grips installed (either black or hydro dipped camo depending on the model purchased). Optional replacement grips are available for purchase from Strassell's Machine, Inc. and can be easily changed by the user.

To change the grips, follow the procedure below.



1. Make sure that the magazine is removed and the manual safety is fully upwards in the on (safe) position.
2. Remove the grip screw by turning it counterclockwise using a Philips head screwdriver. (FIG. 2)



3. Use the dual lok wrench/adjustment tool or a small flat screwdriver to pry the grip panel up and away from the frame. (FIG. 3)

While keeping frame flat on a work surface,



4. Lift the grip panel up and away from the frame.
Note: Removing the grip panel exposes parts inside the frame. Be careful not to remove/dislodge them. (FIG. 4 & 4.1)



5. Align the two tabs on the bottom of the new grip panel with the openings on the frame above the bottom of the magazine well. (FIG. 5)



6. Press the top of the new grip panel down against the frame until it snaps into place.

7. Install the grip screw by turning it clockwise using a Philips head screwdriver. Do not overtighten grip screws, snug is sufficient. (FIG. 7)



8. Repeat steps 2 through 7 to replace the other grip panel.

WARNING Always make sure your Hi-Point pistol is unloaded (both the chamber and the magazine are empty) before installing the Dual Lok. Use of the provided yellow chamber plug is recommended to ensure the pistol is unloaded

Your Hi-Point pistol comes with a Dual Lok trigger lock. The Dual Lok is an extremely simple mechanical lock that consists of two halves connected by a plastic strap.

NOTICE Hi-Point Dual Lok trigger lock is not legal in California.

To install the Dual Lok, follow the instructions below.



1. Align the Dual Lok so that the strap is underneath the trigger guard with the lock head on the right side (the side with the ejection port) of the pistol. (Note: The Dual Lok must be installed with the lock head on the right side to fit properly).

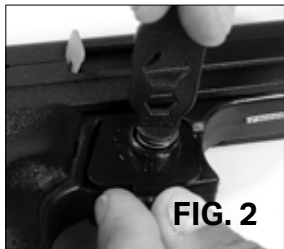

2. Fold the two halves of the Dual Lok upwards and fully press the lock head into the round opening on the other side of the lock. (FIG.1)

3. Insert the two tabs on the end of the Dual Lok wrench/adjustment tool into the indentations on the right and left sides of the lock head. (FIG. 2)

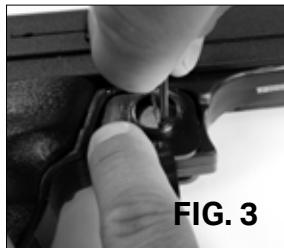

4. Push the lock head fully into the Dual Lok using the Dual Lok wrench/adjustment tool and turn it clockwise. (Note: For additional security, the Dual Lok features an opening through which a small padlock can be installed). (FIG. 3)

To remove the Dual Lok, follow the instructions below. (Note: If you installed a padlock on your Dual Lok, you must remove it first.)

- 1.** Insert the two tabs on the end of the Dual Lok wrench/adjustment tool into the indentations on the right and left sides of the lock head.
- 2.** Push the lock head down into the Dual Lok using the Dual Lok wrench/adjustment tool and turn it counterclockwise, causing the lock head to rise up out of the Dual Lok.
- 3.** Remove the Dual Lok from your Hi-Point pistol by pulling the two halves of the Dual Lok apart.

⚠WARNING Always make sure your Hi-Point pistol is unloaded (both the chamber and the magazine are empty) before storing it.

⚠WARNING Always store your Hi-Point pistol unloaded and locked in a suitable container, out of the reach and sight of children or other unauthorized persons.

⚠WARNING Never store ammunition in the same container as your Hi-Point pistol.

To safely store your unloaded Hi-Point pistol, complete the steps below.

1. Insert the yellow chamber plug into the chamber by partially retracting the slide and inserting the rounded end into the chamber with the slot aligned with the extractor and then closing the slide.
2. Install the Dual Lok following the instructions in Chapter 16.
3. Put your unloaded Hi-Point pistol in a safe or locked storage case, out of the reach and sight of children or other unauthorized persons. It should be stored in a place where it will not become wet or be subjected to high temperatures.

MODEL C9/CF380/CF380 COMP Parts List

Certain parts of your Hi-Point pistol (marked with an *) have to be replaced by returning the pistol to Strassell's Machine, Inc. (Most of these parts are replaced free of charge). The remaining parts are available from Strassell's Machine, Inc. *(The parts shown below correspond to the exploded view on page 50)*

1. Ejection Pin
2. Ejection Key
3. Ejection Spring
4. Slide*
5. Firing Pin
6. Firing Pin Spring
7. Slide Retainer
8. Slide Retainer Pin
9. Sear Spring*
10. Sear Cam*
11. Sear Assembly*
12. Safety
13. Frame with Integrated barrel*
14. Recoil Spring
- 14a. Recoil Spring Guide Rod
15. Trigger Pin
16. Trigger Assembly
17. Grip Screw (2)
18. Grip (2)
19. Magazine Catch Assembly
20. 8 Shot Magazine Assembly
21. Sear Block Spring
22. Sear Block
23. Counter Weight Pivot Pin
24. Counter Weight
25. Magazine Catch Spring
26. Adjustable Rear Sight Assembly
27. Elevation Screw
28. Sight Retainer Screw
29. Adjustable Sight Spring
30. Firing Pin Assist Spring
31. Compensator
(Model CF380 COMP only)
32. Compensator Screw
(Model CF380 COMP only)
33. Compensator Nut
(Model CF380 COMP only)
34. Hold Open Pin
35. Hold Open
36. Hold Open Spring
37. Magazine Lockout
38. Magazine Lockout Spring
39. 10 Shot Magazine Assembly
(Included with Model CF380 COMP, optional with other Models)
40. Compensator Allen Key
(Model CF380 COMP only)
41. Dual Lok Wrench/ Adjustment Tool
42. Dual Lok

EXPLODED DRAWING

MODEL C9/CF380/CF380 COMP Parts

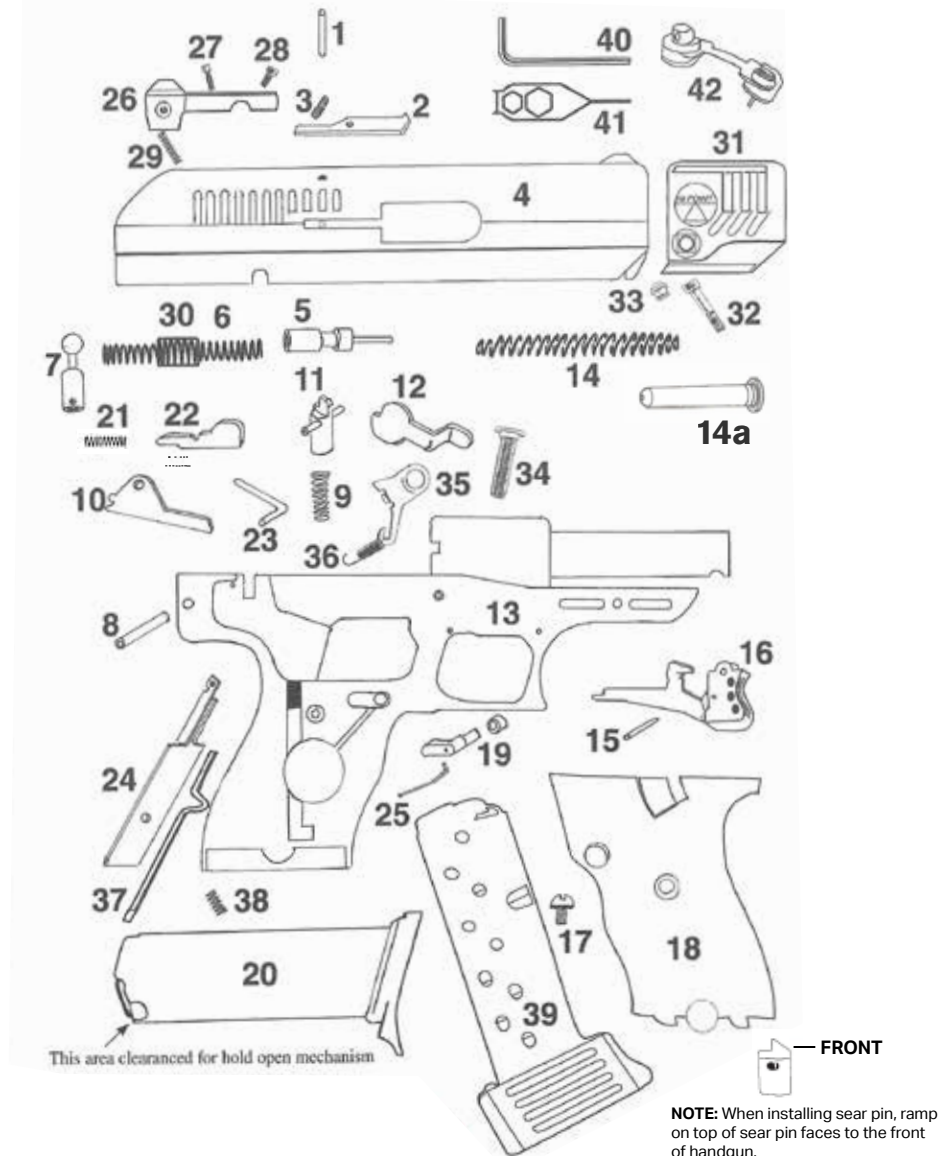

C9	CF380	CF380 Comp
Caliber: 9mm	Caliber: .380 ACP	Caliber: .380 ACP
Barrel length: 3.5"	Barrel length: 3.5"	Barrel length: 4.0"
Overall length: 6.8"	Overall length: 6.8"	Overall length: 8.25"
Overall height: 4.9"	Overall height: 4.9"	Overall height: 4.9"
Overall width: 1.4"	Overall width: 1.4"	Overall width: 1.4"
Weight (unloaded): 29.8 oz	Weight (unloaded): 29.8 oz	Weight (unloaded): 35 oz
Rifling: [3 left twists]	Rifling: [9 left twists]	Rifling: [9 left twists]
Magazine capacity: 8 rounds 10 rounds (Optional)	Magazine capacity: 8 rounds 10 rounds (Optional)	Magazine capacity: 8 rounds and 10 rounds

Subject to the terms, conditions and limitations outlined below, Strassell's Machine, Inc. guarantees your Hi-Point pistol against defects in materials and workmanship that adversely affect its operation for life, regardless of whether or not you are the original purchaser. **Warranty does not cover loss or theft.**

To make a claim under this warranty, contact Strassell's Machine, Inc. at: 1015 Springmill Road Mansfield, OH 44904, or by telephone at (419) 747-9444 for instructions on how to return your Hi-Point pistol. Do not return your Hi-Point pistol for service without prior authorization.

LIMITATIONS OF WARRANTY

The warranty will be void if any of the following occur:

- 1. The instructions in the Instruction Manual are not followed.**
- 2. Your Hi-Point pistol or any of its parts are altered or modified from their original state. Hi-Point Firearms does not warrant that your firearm will function properly with aftermarket parts or accessories installed. This includes silencers and muzzle devices.**
- 3. Damage is caused by misuse, abuse or improper maintenance.**
- 4. Damage is caused by reloaded or remanufactured ammunition, or ammunition that does not meet SAAMI, CIP or NATO standards. or**
- 5. Your Hi-Point pistol is disassembled beyond the instructions in Chapters 9 of the Instruction Manual.**

There are no warranties that extend beyond the description on the face hereof.

The sole and exclusive remedy pursuant to this warranty is the repair or replacement of your Hi-Point pistol at the sole discretion of Strassell's Machine, Inc.

The implied warranties of merchantability and fitness for a particular purpose are expressly limited to one year from the date of the original retail purchase of your Hi-Point pistol.

All disclaimers and limitations of liability shall still apply even if the limited remedy of repair and replacement fails of its essential purpose.

In states where permitted, Strassell's Machine, Inc. assumes no liability for incidental or consequential damages or for incidental expenses.

Any action against Strassell's Machine, Inc. based on an alleged breach of this warranty must be brought within one (1) year of the claimed breach.

Strassell's Machine, Inc.'s liability for breach of warranty shall be limited to repair or replacement of your Hi-Point pistol at the sole discretion of Strassell's Machine, Inc.

- (1) The misuse of handguns is a leading contributor to juvenile violence and fatalities.
- (2) Safely storing and securing firearms away from children will help prevent the unlawful possession of handguns by juveniles, stop accidents, and save lives.
- (3) Federal law prohibits, except in certain limited circumstances, anyone under 18 years of age from knowingly possessing a handgun, or any person from selling, delivering, or otherwise transferring a handgun to a person under 18.
- (4) A knowing violation of the prohibition against selling, delivering, or otherwise transferring a handgun to a person under the age of 18 is, under certain circumstances, punishable by up to 10 years in prison.

FEDERAL LAW

The Gun Control Act of 1968, 18 U.S.C. Chapter 44, provides in pertinent part as follows:

18 U.S.C. § 922(x)

- (1) It shall be unlawful for a person to sell, deliver, or otherwise transfer to a person who the transferor knows or has reasonable cause to believe is a juvenile—
 - (A) a handgun; or
 - (B) ammunition that is suitable for use only in a handgun.
- (2) It shall be unlawful for any person who is a juvenile to knowingly possess—
 - (A) a handgun; or
 - (B) ammunition that is suitable for use only in a handgun.
- (3) This subsection does not apply to—
 - (A) a temporary transfer of a handgun or ammunition to a juvenile or to the possession or use of a handgun or ammunition by a juvenile if the handgun and ammunition are possessed and used by the juvenile—

(i) in the course of employment, in the course of ranching or farming related to activities at the residence of the juvenile (or on property used for ranching or farming at which the juvenile, with the permission of the property owner or lessee, is performing activities related to the operation of the farm or ranch), target practice, hunting, or a course of instruction in the safe and lawful use of a handgun;

(ii) with the prior written consent of the juvenile's parent or guardian who is not prohibited by Federal, State, or local law from possessing a firearm, except—

(l) during transportation by the juvenile of an unloaded handgun in a locked container directly from the place of transfer to a place at which an activity described in clause (i) is to take place and transportation by the juvenile of that handgun, unloaded and in a locked container, directly from the place at which such an activity took place to the transferor; or

(ll) with respect to ranching or farming activities as described in clause (i), a juvenile may possess and use a handgun or ammunition with the prior written approval of the juvenile's parent or legal guardian and at the direction of an adult who is not prohibited by Federal, State or local law from possessing a firearm;

(iii) the juvenile has the prior written consent in the juvenile's possession at all times when a handgun is in the possession of the juvenile; and

(iv) in accordance with State and local law;

(B) a juvenile who is a member of the Armed Forces of the United States or the National Guard who possesses or is armed with a handgun in the line of duty;

(C) a transfer by inheritance of title (but not possession) of a handgun or ammunition to a juvenile; or

(D) the possession of a handgun or ammunition by a juvenile taken in defense of the juvenile or other persons against an intruder into the residence of the juvenile or a residence in which the juvenile is an invited guest.

(4) A handgun or ammunition, the possession of which is transferred to a juvenile in circumstances in which the transfer or is not in violation of this subsection shall not be

subject to permanent confiscation by the Government if its possession by the juvenile subsequently becomes unlawful because of the conduct of the juvenile, but shall be returned to the lawful owner when such handgun or ammunition is no longer required by the Government for the purposes of investigation or prosecution.

(5) For purposes of this subsection, the term "juvenile" means a person who is less than 18 years of age.

(6)(A) In a prosecution of a violation of this subsection, the court shall require the presence of a juvenile defendant's parent or legal guardian at all proceedings.

(B) The court may use the contempt power to enforce subparagraph (A).

(C) The court may excuse attendance of a parent or legal guardian of a juvenile defendant at a proceeding in a prosecution of a violation of this subsection for good cause shown.

18 U.S.C. § 924(a)(6)

(A)(i) A juvenile who violates section 922(x) shall be fined under this title, imprisoned not more than 1 year, or both, except that a juvenile described in clause (ii) shall be sentenced to probation on appropriate conditions and shall not be incarcerated unless the juvenile fails to comply with a condition of probation.

(ii) A juvenile is described in this clause if—

(I) the offense of which the juvenile is charged is possession of a handgun or ammunition in violation of section 922(x)(2); and

(II) the juvenile has not been convicted in any court of an offense (including an offense under section 922(x) or a similar State law, but not including any other offense consisting of conduct that if engaged in by an adult would not constitute an offense) or adjudicated as a juvenile delinquent for conduct that if engaged in by an adult would constitute an offense.

(B) A person other than a juvenile who knowingly violates section 922(x)—

(i) shall be fined under this title, imprisoned not more than 1 year, or both; and

(ii) if the person sold, delivered, or otherwise transferred a handgun or ammunition to a juvenile knowing or having reasonable cause to know that the juvenile intended to carry or otherwise possess or discharge or otherwise use the handgun or ammunition in the commission of a crime of violence, shall be fined under this title, imprisoned not more than 10 years, or both.

The following warnings are required by certain jurisdictions.

CALIFORNIA

⚠️WARNING: "Firearms must be handled responsibly and securely stored to prevent access by children and other unauthorized users. California has strict laws pertaining to firearms, and you may be fined or imprisoned if you fail to comply with them. Visit the Web site of the California Attorney General at <https://oag.ca.gov/firearms> for information on firearm laws applicable to you and how you can comply. Prevent child access by always keeping guns locked away and unloaded when not in use. If you keep a loaded firearm where a child obtains and improperly uses it, you may be fined or sent to prison."

⚠️ADVERTENCIA: "Las armas de fuego deben manipularse de manera responsable y segura para evitar el acceso de niños y otros usuarios no autorizados. California tiene leyes estrictas relacionadas con armas de fuego, y usted puede ser multado o encarcelado si no las cumple. Visite la pagina web del Procurador General de California en <https://oag.ca.gov/firearms> para obtener información sobre las leyes de armas de fuego que le son aplicables y cómo puede cumplirlas. Evite el acceso de niños manteniendo siempre las armas bloqueadas y descargadas cuando no estén en uso. Si mantiene un arma de fuego cargada donde un niño obtiene y la usa indebidamente, se le puede multar o enviar a prisión."

CONNECTICUT

"UNLAWFUL STORAGE OF A LOADED FIREARM MAY RESULT IN IMPRISONMENT OR FINE."

FLORIDA

"IT IS UNLAWFUL, AND PUNISHABLE BY IMPRISONMENT AND FINE, FOR ANY ADULT TO STORE OR LEAVE A FIREARM IN ANY PLACE WITHIN THE REACH OR EASY ACCESS OF A MINOR UNDER 18 YEARS OF AGE OR TO KNOWINGLY SELL OR OTHERWISE TRANSFER OWNERSHIP OR POSSESSION OF A FIREARM TO A MINOR OR A PERSON OF UNSOUND MIND."

MAINE

"ENDANGERING THE WELFARE OF A CHILD IS A CRIME. IF YOU LEAVE A FIREARM AND AMMUNITION WITHIN EASY ACCESS OF A CHILD, YOU MAY BE SUBJECT TO FINE, IMPRISONMENT OR BOTH. KEEP FIREARMS AND AMMUNITION LOCKED UP. USE TRIGGER LOCKS."

MARYLAND

WARNING: "Children can operate firearms which may cause death or serious injury. It is a crime to store or leave a loaded firearm in any location where an individual knew or should have known that an unsupervised minor would gain access to the firearm. Store your firearm responsibly!"

MASSACHUSETTS

"WARNING FROM THE MASSACHUSETTS ATTORNEY GENERAL: This handgun is not equipped with a device that fully blocks use by unauthorized users. More than 200,000 firearms like this one are stolen from their owners every year in the United States. In addition, there are more than a thousand suicides each year by younger children and teenagers who get access to firearms. Hundreds more die from accidental discharge. It is likely that many more children sustain serious wounds, or inflict such wounds accidentally on others. In order to limit the chance of such misuse, it is imperative that you keep this weapon locked in a secure place and take reasonable preventive steps necessary to limit the possibility of theft or accident. Failure to take reasonable preventive steps may result in innocent lives being lost, and in some circumstances may result in your liability for these deaths."

"IT IS UNLAWFUL TO STORE OR KEEP A FIREARM, RIFLE, SHOTGUN OR MACHINE GUN IN ANY PLACE UNLESS THAT WEAPON IS EQUIPPED WITH A TAMPER-RESISTANT SAFETY DEVICE OR IS STORED OR KEPT IN A SECURELY LOCKED CONTAINER."

NEW JERSEY

"IT IS A CRIMINAL OFFENSE, PUNISHABLE BY A FINE AND IMPRISONMENT, FOR AN ADULT TO LEAVE A LOADED FIREARM WITHIN EASY ACCESS OF A MINOR."

NEW YORK CITY

"THE USE OF A LOCKING DEVICE OR SAFETY LOCK IS ONLY ONE ASPECT OF RESPONSIBLE WEAPON STORAGE. ALL WEAPONS SHOULD BE STORED UNLOADED AND LOCKED IN A LOCATION THAT IS BOTH SEPARATE FROM THEIR AMMUNITION AND INACCESSIBLE TO CHILDREN AND ANY OTHER UNAUTHORIZED PERSONS."

NORTH CAROLINA

"IT IS UNLAWFUL TO STORE OR LEAVE A FIREARM THAT CAN BE DISCHARGED IN A MANNER THAT A REASONABLE PERSON SHOULD KNOW IS ACCESSIBLE TO A MINOR."

"Any person who resides in the same premises as a minor, owns or possesses a firearm, and stores or leaves the firearm (i) in a condition that the firearm can be discharged and (ii) in a manner that the person knew or should have known that an unsupervised minor would be able to gain access to the firearm, is guilty of a Class 1 misdemeanor if a minor gains access to the firearm without the lawful permission of the minor's parents or a person having charge of the minor and the minor: (1) Possesses it in violation of G.S. 14-269.2(b); (2) Exhibits it in a public place in a careless, angry, or threatening manner; (3) Causes personal injury or death with it not in self defense; or (4) Uses it in the commission of a crime."

TEXAS

"IT IS UNLAWFUL TO STORE, TRANSPORT, OR ABANDON AN UNSECURED FIREARM IN A PLACE WHERE CHILDREN ARE LIKELY TO BE AND CAN OBTAIN ACCESS TO THE FIREARM."

WISCONSIN

"IF YOU LEAVE A LOADED FIREARM WITHIN THE REACH OR EASY ACCESS OF A CHILD YOU MAY BE FINED OR IMPRISONED OR BOTH IF THE CHILD IMPROPERLY DISCHARGES, POSSESSES, OR EXHIBITS THE FIREARM."

State laws and regulations concerning firearms change constantly. Please check with your State Attorney General's Office or state police for additional laws and regulations regarding the storage and use of firearms in your state.

HI-POINT FIREARMS

INSTRUCTION MANUAL

MODEL C9 9MM

MODEL CF380 .380 ACP

MODEL CF380 COMP

CONTACT:

419-747-9444



HI-POINT[®]
FIREARMS