

Kimber



Revolver Safety & Instruction Manual

⚠ WARNING

BEFORE USING THIS FIREARM, CAREFULLY READ THIS MANUAL IN ITS ENTIRETY. UNDERSTAND AND FOLLOW ALL INSTRUCTIONS AND WARNINGS.

THIS MANUAL SHOULD ALWAYS ACCOMPANY THIS FIREARM AND BE TRANSFERRED WITH THE FIREARM UPON CHANGE OF OWNERSHIP, OR WHEN THE FIREARM IS LOANED OR PRESENTED TO ANOTHER PERSON.

A COPY OF THIS MANUAL IS AVAILABLE FREE VIA DOWNLOAD FROM WWW.KIMBERAMERICA.COM OR UPON REQUEST FROM KIMBER CUSTOMER SERVICE BY CALLING (888) 243-4522.

What All Guns Should Be™

Kimber Revolver Models

Safety & Instruction Manual

WARNING

BEFORE USING THIS FIREARM, CAREFULLY READ THIS MANUAL IN ITS ENTIRETY. UNDERSTAND AND FOLLOW ALL INSTRUCTIONS AND WARNINGS.

THIS MANUAL SHOULD ALWAYS ACCOMPANY THIS FIREARM AND BE TRANSFERRED WITH THE FIREARM UPON CHANGE OF OWNERSHIP, OR WHEN THE FIREARM IS LOANED OR PRESENTED TO ANOTHER PERSON.

A COPY OF THIS MANUAL IS AVAILABLE FREE VIA DOWNLOAD FROM WWW.KIMBERAMERICA.COM OR UPON REQUEST FROM KIMBER CUSTOMER SERVICE BY CALLING (888) 243-4522.

IF THERE IS ANYTHING IN THIS MANUAL YOU DO NOT UNDERSTAND, ASK YOUR RETAILER OR CALL KIMBER AT (888) 243-4522.

HOW TO USE THIS MANUAL

This manual is not a comprehensive guide to firearm safety. Kimber® highly recommends that new shooters seek professional training from qualified instructors prior to handling any firearm. To help ensure safe and long-term enjoyment of a Kimber firearm, this manual should be read in its entirety and thoroughly understood.

Safety

Carefully review the information presented in this section and commit it to memory prior to loading, firing or otherwise handling or using a firearm.

Specifications

Primary product specifications are included in this section. Additionally, this section will have information if a procedure relates to more than one model, or if it is important to note differences between similar models.

Operation

This section includes descriptions of basic operations such as loading, unloading and clearing. Operations are presented in a sequential, step-by-step format. Exploded diagrams are provided for reference to help identify components and understand correct procedures of important functions. Please note that some illustrations may differ in appearance between models. This should

not be of concern as the procedure itself remains accurate in such instances.

Care

A dedicated maintenance schedule should be followed to help ensure that your Kimber firearm performs at its best. Performing preventative maintenance is not only an essential safety practice, it is necessary to help ensure the longevity of a firearm. This section of the manual includes cleaning and lubrication instructions for each Kimber model as well as instructions regarding long term storage. Adhering to these instructions will undoubtedly help extend the life of a Kimber firearm.

Support

Refer to this section for information on warranty coverage, available parts, product diagrams, Custom Shop treatments, customer service and returning a firearm.

ADDITIONAL ASSISTANCE

If a question or concern is not addressed within this manual, please contact Kimber Customer Service at (888) 243-4522 during business hours. A digital volume of this and other Kimber product manuals are available for download at www.kimberamerica.com.

This manual contains several safety warnings and instructions preceded with, **⚠️WARNING**, **⚠️CAUTION**, or **NOTICE**. These signal words are designed to draw your attention to important safety information. In certain situations, this manual also includes a NOTE.

⚠️WARNING

Indicates a condition or circumstances where failure to follow the Warning could result in death, serious injury and/or property damage.

⚠️CAUTION

Indicates a condition or circumstance where failure to follow the Caution could result in minor or moderate injury, and/or property damage.

NOTICE

Addresses safety or other practices or information not related to personal injury. Failure to follow the Notice could result in property damage.

NOTE

In certain situations this manual may also have a NOTE. A "NOTE" provides additional information regarding the use and function of this firearm, or highlights other important points.

WARNINGS

WARNING

This product is a firearm and can be a lethal weapon. Failure to read and properly follow the instructions and warnings in this manual could result in death, serious injury or damage to property.

WARNING

Do not attempt to practice loading or unloading, firing or otherwise handling or using this firearm without a thorough understanding of its safe operation.

WARNING

Always treat a firearm as if it were fully loaded.

WARNING

Always store this firearm with the chambers empty. Failure to do so could result in an unintentional discharge.

WARNING

It is recommended that you should have training from a qualified instructor prior to holstering, drawing and carrying a loaded firearm. Never carry this firearm loaded unless you have obtained such training. Failure to do so could result in an unintentional discharge.

WARNING

Keep out of reach of children. For increased safety, firearms should be stored unloaded in a location that is secure and inaccessible to children and any other unauthorized person and with ammunition locked securely in a different location.

⚠️ WARNING

When you pull the trigger with a loaded firearm, you must expect the firearm to fire and take full responsibility for your actions.

⚠️ WARNING

Read through the entire manual before attempting to use this product. Safe operation of this firearm is your obligation, and requires that you completely read and understand this manual in its entirety.

STATE-BY-STATE WARNINGS

Certain states require, by law, that their own specified warning notices be conspicuously included in larger than normal type by the manufacturer, distributor or retail dealer with firearms sold in that state. Kimber Mfg., Inc. sells products in compliance with applicable laws and regulations. As Kimber products may be sold in these states, the following warnings are included:

CALIFORNIA:

WARNING

“Children are attracted to and can operate firearms that can cause severe injuries or death. Prevent child access by always keeping guns locked away and unloaded when not in use. If you keep a loaded firearm where a child obtains and improperly uses it, you may be fined or sent to prison.”

ADVERTENCIA

“A los niños los atraen las armas de fuego y las pueden causarse lesiones graves y la muerte. Evite que los niños tengan acceso a las armas de fuego guardándolas siempre con llave y descargadas cuando no las esté utilizando. Si usted tiene un arma de fuego cargada en un lugar en que un niño tiene acceso a ella y la usa indebidamente, le pueden dar una multa o enviarlo a la cárcel.”

CONNECTICUT:

“UNLAWFUL STORAGE OF A LOADED FIREARM MAY RESULT IN IMPRISONMENT OR FINE.”

FLORIDA:

“IT IS UNLAWFUL, AND PUNISHABLE BY IMPRISONMENT AND FINE, FOR ANY ADULT TO STORE OR LEAVE A FIREARM IN ANY PLACE WITHIN THE REACH OR EASY ACCESS OF A MINOR UNDER 18 YEARS OF AGE OR TO KNOWINGLY SELL OR OTHERWISE TRANSFER OWNERSHIP OR POSSESSION OF A FIREARM TO A MINOR OR A PERSON OF UNSOUND MIND.”

MAINE:

“ENDANGERING THE WELFARE OF A CHILD IS A CRIME. IF YOU LEAVE A FIREARM AND AMMUNITION WITHIN EASY ACCESS OF A CHILD, YOU MAY BE SUBJECT TO FINE, IMPRISONMENT OR BOTH. KEEP FIREARMS AND AMMUNITION SEPARATE. KEEP FIREARMS AND AMMUNITION LOCKED UP. USE TRIGGER LOCKS.”

MARYLAND:

“WARNING: Children can operate firearms which may cause death or serious injury. It is a crime to store or leave a loaded firearm in any location where an individual knew or should have known that an unsupervised minor would gain access to the firearm. Store your firearm responsibly!”

STATE-BY-STATE WARNINGS

MASSACHUSETTS:

“WARNING FROM THE MASSACHUSETTS ATTORNEY GENERAL: This handgun is not equipped with a device that fully blocks use by unauthorized users. More than 200,000 firearms like this one are stolen from their owners every year in the United States. In addition, there are more than a thousand suicides each year by younger children and teenagers who get access to firearms. Hundreds more die from accidental discharge. It is likely that many more children sustain serious wounds, or inflict such wounds accidentally on others. In order to limit the chance of such misuse, it is imperative that you keep this weapon locked in a secure place and take other steps necessary to limit the possibility of theft or accident. Failure to take reasonable preventive steps may result in innocent lives being lost, and in some circumstances may result in your liability for these deaths.”

“IT IS UNLAWFUL TO STORE OR KEEP A FIREARM, RIFLE, SHOTGUN OR MACHINE GUN IN ANY PLACE UNLESS THAT WEAPON IS EQUIPPED WITH A TAMPER-RESISTANT SAFETY DEVICE OR IS STORED OR KEPT IN A SECURELY LOCKED CONTAINER.”

NEW JERSEY:

“IT IS A CRIMINAL OFFENSE TO LEAVE A LOADED FIREARM WITHIN EASY ACCESS OF A MINOR.”

NEW YORK CITY, NY:

“THE USE OF A LOCKING DEVICE OR SAFETY LOCK IS ONLY ONE ASPECT OF RESPONSIBLE WEAPON STORAGE. ALL WEAPONS SHOULD BE STORED UNLOADED AND LOCKED IN A LOCATION THAT IS BOTH SEPARATE FROM THEIR AMMUNITION AND INACCESSIBLE TO CHILDREN AND ANY OTHER UNAUTHORIZED PERSONS. NEW YORK CITY LAW PROHIBITS, WITH CERTAIN EXCEPTIONS, ANY PERSON FROM ACQUIRING MORE THAN ONE

FIREARM, OR MORE THAN ONE RIFLE OR SHOTGUN,
WITHIN A 90-DAY PERIOD.”

NORTH CAROLINA:

“IT IS UNLAWFUL TO STORE OR LEAVE A FIREARM
THAT CAN BE DISCHARGED IN A MANNER THAT A
REASONABLE PERSON SHOULD KNOW IS ACCESSIBLE
TO A MINOR.”

TEXAS:

“IT IS UNLAWFUL TO STORE, TRANSPORT, OR
ABANDON AN UNSECURED FIREARM IN A PLACE
WHERE CHILDREN ARE LIKELY TO BE AND CAN
OBTAIN ACCESS TO THE FIREARM.”

WISCONSIN:

“IF YOU LEAVE A LOADED FIREARM WITHIN THE
REACH OR EASY ACCESS OF A CHILD YOU MAY
BE FINED OR IMPRISONED OR BOTH IF THE CHILD
IMPROPERLY DISCHARGES, POSSESSES OR EXHIBITS
THE FIREARM.”

NOTE

The above warnings are not intended to be
exhaustive. Laws and regulations change
constantly. Please check with a licensed
retailer or local law enforcement authority
regarding laws and regulations that may
be applicable.

CONTENTS

| | |
|----------------------------------|----|
| Safety | 18 |
| Rules of firearm safety | 19 |
| Cable lock | 23 |
| Eye and hearing protection | 25 |
| Safety warnings | 25 |
| Specifications | 28 |
| Operation | 30 |
| Performance features | 30 |
| Safety features | 31 |
| Basic operation | 32 |
| Care | 46 |
| Preventative maintenance | 46 |
| Long-term storage | 49 |

| | |
|--|----|
| Support | 52 |
| Warranty | 52 |
| Obtaining Kimber replacement parts | 54 |
| Custom Shop treatments | 54 |
| Customer Service | 54 |
| Notable parts list | 56 |
| Returning a firearm | 57 |

Safety

Specifications

Operation

Care

Support

SAFETY

Thank you for trusting your next shot to Kimber®.

Kimber was founded with the singular purpose of building fine sporting firearms, better even than the classics from the golden age of American gunmaking. Today more than ever, the reputation of the Kimber brand reflects the original purpose - and Kimber is known as America's leading manufacturer of premium production firearms. Nearly 100 Kimber models offer a wide variety of sizes, weights, calibers and features. Each is proudly made in America and will provide several lifetimes of service with proper operation and care.

▲WARNING

Read through the entire manual before attempting to use this product. Safe operation of this firearm is your obligation, and requires that you completely read and understand this manual in its entirety.

NOTICE

Kimber Mfg., Inc. shall not be responsible for any death, physical injury or property damage that is the result of the proper or improper use of this product.

Rules of firearm safety

▲WARNING

- Always treat this and any other firearm as if it were loaded. Never take anyone's word that a firearm is unloaded. Clear it yourself with finger off the trigger and the muzzle pointed in a safe direction. Open the cylinder then visually and physically check to ensure that no round is chambered. Always make sure the firearm is unloaded and the cylinder is open before laying it down or handing it to someone else.

▲WARNING

- Prior to use, learn the mechanical and handling characteristics, and operation of the firearm you are using. Not all firearms are the same.

▲WARNING

- Always keep the muzzle pointed in a safe direction. Never point this or any other firearm at anything you do not intend to shoot.

SAFETY

▲WARNING

- Never place your finger inside the trigger guard or on the trigger unless you intend to fire.

▲WARNING

- Never carry a firearm loaded unless you have first obtained training from a qualified instructor in holstering, drawing and carrying a loaded handgun.

▲WARNING

- Do not carry a loaded firearm with a live round in the chamber while walking, running, crossing or climbing a fence, stream, ditch or any obstacle, or where there is any possibility of slipping or falling, as this could lead to a possible unintentional discharge.

▲WARNING

- Always make sure that this firearm is in top working condition and that no internal or external parts have been damaged as a result of corrosion, improper maintenance or dropping. If evidence of these conditions exist, have it inspected by a competent gunsmith or contact Kimber prior to use.

▲WARNING

- Firearms should be unloaded when not actually in use. For increased safety, firearms should be stored unloaded in a location that is secure (for example, apply the supplied cable lock to the firearm and lock the firearm in a gun safe) and inaccessible to children and any other unauthorized person, with ammunition locked securely in a different location.

▲WARNING

- Never leave a loaded firearm unattended. Someone, especially a child, may fire it and cause death, serious injury or damage to property.

▲WARNING

- Any firearm that is not under your direct immediate control should be unloaded and rendered inoperable (for example, by use of a cable lock) and inaccessible to unauthorized users.

▲WARNING

- Be sure of your target and beyond. Make sure that your backstop is adequate to stop bullets prior to shooting.

▲WARNING

- While on the range, be sure to carry this firearm cleared, with the cylinder open and muzzle pointed in a safe direction, until ready to shoot.

▲WARNING

- Obey all range rules at all times.

▲WARNING

- Always wear adequate hearing and eye protection when using any firearm.

▲WARNING

- Always ensure that barrel and action are clear of obstructions before shooting. Shooting a blocked firearm can result in death or serious injury and damage to the firearm and/or property.

▲WARNING

- Do not rely on your firearm's "safety" or other mechanical devices. Any mechanical device can fail. Always point the muzzle in a safe direction.

▲WARNING

- Use correct ammunition.

▲WARNING

- Do not alter or modify your firearm and have firearms serviced regularly.

▲WARNING

- Never drink alcoholic beverages or take drugs prior to or during shooting or handling of this or any other firearm, as this could affect or impair your vision, coordination and judgment, and may have other legal consequences.

▲WARNING

- Seek a doctor's advice if you are taking any medication prior to engaging in any shooting activity.

▲WARNING

- Immediately unload and clear this firearm when shooting sequence has been completed.

▲WARNING

- Never shoot at any hard or flat surface, such as rock, metal or water. The resulting ricochet could result in death, serious injury or property damage.

SAFETY

▲WARNING

- Always make sure the firearm is unloaded before cleaning.

▲WARNING

- If your firearm fails to fire when the trigger is pulled, handle with care. If the firearm fails to fire when the trigger is pulled, slow primer ignition (hangfire) may possibly be the cause.

Keep the muzzle pointed downrange at the target for a minimum of 30 seconds. If the round still does not fire, open the cylinder, extract the cartridges from the firearm while keeping the muzzle pointed in a safe direction, and examine the extracted, unfired cartridge(s). If the indent from the firing pin is off center, light or absent, take the firearm to a competent gunsmith. If the indent appears normal compared to other rounds, assume a faulty round, separate from other cartridges, reload and continue shooting.

▲WARNING

- Immediately stop firing and unload your revolver if the report or recoil seems weak or is otherwise unusual. After unloading the firearm, check to be sure that no obstruction has become lodged in the barrel.

▲WARNING

- Never use this firearm in any manner other than that for which it was specifically designed.

▲WARNING

- Never act in an irresponsible manner or ignore any established rules of safety when using or storing firearms.

▲CAUTION

- Make sure all other shooters and bystanders are behind the shooter and well away from the barrel-cylinder gap. Hot gases, powder grains, lead and/or metal particles, and lubricant escape at high velocity when firing and may cause injury if someone is too close to the barrel-cylinder gap.

CAUTION

- Never shoot the firearm with your thumb or other body part near or in the path of the barrel-cylinder gap, or you could be injured by hot gases, powder grains, lead and/or metal particles and lubricant escaping at high velocity.

Cable lock

To use cable lock provided with this firearm:

1. Point the muzzle of the firearm in a safe direction and keep fingers outside of the trigger guard and clear of the trigger throughout the following steps.
2. Unload the firearm following the unloading procedures specified in this manual (see pages 37–38), finishing by visually confirming that the chambers are clear of ammunition. We recommend that the chambers be unloaded and ammunition be stored separately.

3. Ensure the cylinder is open.
4. Take the open end of the cable lock and direct it down through one of the chambers and out through the front of the cylinder. Insert the open end into the lock, then turn and remove the key. Keep the key stored in a separate location from the firearm, lock and unauthorized person, and out of reach of children.

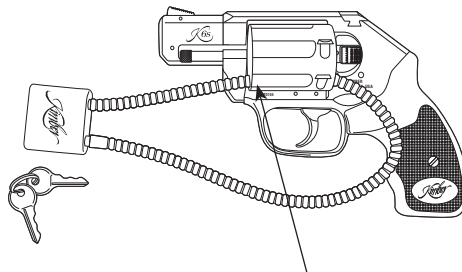

Proper placement of cable lock

SAFETY

⚠️WARNING

IMPROPER INSTALLATION OF CABLE LOCK

Improper installation of the cable lock through the trigger guard can result in accidental discharge causing death, serious injury or property damage. While locking devices are an important aid to security measures, they are not a substitute for safe firearm handling and proper storage. Mechanical and locking devices can fail and/or be bypassed with enough time, knowledge, determination and equipment.

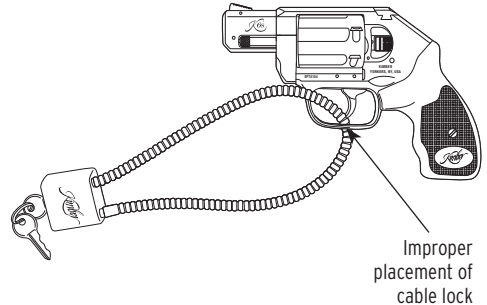

EYE AND HEARING PROTECTION

Always wear safety glasses that meet the requirements of the American National Standards Institute (ANSI) Z87.1 and commercially manufactured hearing protection when shooting.

Additionally, those in close proximity when shooting should also wear the appropriate eye and hearing protection. All revolvers forcefully eject hot gases, powder grains, lead and/or metal particles and lubricant during shooting.

Such discharge is normal. If you and/or others in close physical proximity do not wear appropriate eye protection, then you risk a serious, permanent eye injury up to and possibly including blindness. Hearing protection at all times during shooting is necessary to help prevent partial or permanent hearing loss.

WARNING

Always wear the appropriate eye and hearing protection during shooting. Failure to do so may result in hearing loss and/or eye injury.

Lead Exposure

WARNING

Discharging firearms in poorly ventilated areas, cleaning firearms or handling ammunition may result in exposure to lead and other substances known to cause birth defects, reproductive harm, cancer and other serious physical injury. Have adequate ventilation at all times. Wash hands thoroughly after exposure.

SAFETY

WARNING

This product was designed to function properly in its original condition. Do not alter any part or add or substitute parts or accessories not made or authorized for use by Kimber. Any such alteration could render the firearm unsafe and will void the warranty.

WARNING

Do not drop or allow anything to strike the firearm, as with any firearm an accidental discharge may result.

WARNING

Firearm safety is every firearm owner's responsibility. Failure to review, understand and follow all rules of safety, instructions and procedures included in this manual could result in death, serious injury or property damage.

WARNING

Always treat this and any other firearm as if it were loaded.

WARNING

Prior to use, learn the mechanical and handling characteristics, and operation of the firearm you are using. Not all firearms are the same.

⚠️ WARNING

Always keep the muzzle pointed in a safe direction.

⚠️ WARNING

Never place your finger inside the trigger guard or on the trigger unless you intend to fire.

⚠️ WARNING

Do not attempt to practice loading or unloading, firing or otherwise handling or using this firearm without a thorough understanding of its safe operation.

⚠️ WARNING

Always store this firearm with the chambers empty. Failure to do so could result in an unintentional discharge.

⚠️ WARNING

It is recommended that you should have training from a qualified instructor prior to holstering, drawing and carrying a loaded handgun. Failure to do so could result in an unintentional discharge.

⚠️ WARNING

Keep out of reach of children. For increased safety, firearms should be stored unloaded in a location that is secure and inaccessible to children and any other unauthorized person. Ammunition should be locked securely in a different location.

⚠️ WARNING

Read through the entire manual before attempting to use this product. Safe operation of this firearm is your obligation, and requires that you completely read and understand this manual in its entirety.

SPECIFICATIONS

| | |
|-------------------------|---|
| Caliber | .357 Magnum (marked on barrel), can also fire .38 Special +P and .38 Special |
| Barrel | 2-inch stainless steel |
| Operation | Double action only |
| Weight (unloaded) | 23 ounces |
| Height | 4.46 inches |
| Length | 6.62 inches |
| Width | 1.39 inches |
| Frame | Stainless steel |
| Cylinder capacity | 6 rounds |
| Safety devices | Internal hammer block |

OPERATION

Performance features

K6S revolver

1. Front sight
2. Barrel
3. Front locking bolt
4. Extractor rod
5. Crane
6. Cylinder
7. Barrel-cylinder gap
8. Trigger guard
9. Trigger
10. Cylinder release button
11. Rear sight
12. Grip

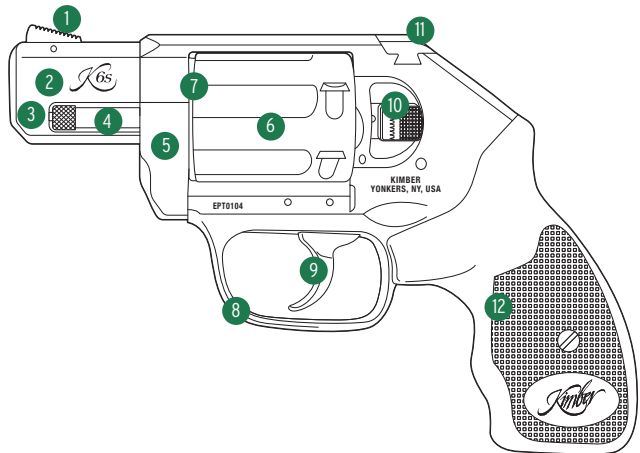

Safety features

The revolver is equipped with safety features which can, if properly used, help minimize the danger of an unintentional discharge.

⚠️ WARNING

While this firearm has design features to help prevent an unintentional discharge if the firearm is dropped or hit, never exclusively rely on such features as mechanical devices can fail, and such features are not a substitute for safe handling practices and proper maintenance.

Trigger guard

The trigger guard is a portion of the frame that surrounds the trigger, protecting it against damage and accidental discharge.

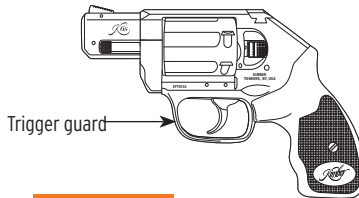

⚠️ WARNING

Never put your finger inside the trigger guard until you intend to fire.

Internal hammer block

An internal hammer block prevents the hammer from contacting the firing pin unless the trigger is pulled to the rear.

⚠️ WARNING

Read through the entire manual before attempting to use this product. Safe operation of this firearm is your obligation, and requires that you completely read and understand this manual in its entirety.

OPERATION

Basic operation

Ammunition

Kimber firearms are designed to function effectively with quality factory-manufactured ammunition in the caliber for which the firearm is chambered. The following is information to help avoid potential ammunition related problems.

1. Kimber recommends the use of high quality American factory-made ammunition.
2. Do not oil cartridges or spray lubricants, preservatives or cleaners on cartridges or where excess spray may come into contact with cartridges. Lubricants and other foreign matter on cartridges may cause potentially dangerous ammunition malfunctions. Use only ammunition of the caliber for which a firearm is chambered.
3. The use of reloaded, hand-loaded, remanufactured or other non-standard ammunition voids all warranties. Kimber specifically disclaims responsibility for any injury or damage whatsoever occurring in connection with, or as a result of, the use in Kimber firearms of faulty, reloaded, hand-loaded, remanufactured or other non-standard ammunition, or of cartridges other than those for which the firearm was originally chambered.
4. Use only ammunition of the caliber for which a firearm is chambered. Improper ammunition and improperly loaded ammunition can be extremely dangerous. Severe damage to the firearm and serious injury to the shooter or to others may result. Always use ammunition that complies with the industry performance standards established by SAAMI. **Death, serious injury, or damage to the firearm**

may result from any condition causing excessive pressure inside the chamber or barrel when a round is fired. Excess pressure may be caused by obstruction in the barrel, propellant powder overloads or by the use of incorrect or improperly-assembled cartridges. In addition, the use of a dirty, corroded or damaged cartridge may lead to a burst case and consequent damage to the firearm and personal injury from the sudden escape of high-pressure propellant gas within the firearm's mechanism.

5. Immediately stop shooting, unload the firearm as directed in this manual (see pages 37–38), and check the barrel for a possible obstruction whenever:
 - The trigger and/or cylinder binds, or
 - Unburned grains of powder are noticed in or around the firearm, or

- **A shot sounds weak or abnormal, or recoil is less than usual**

In the above and other cases, it is possible that a bullet is lodged part way down the barrel. Firing a subsequent bullet into an obstructed barrel may cause death or serious injury and will result in damage to the firearm.

OPERATION

Bullets may become lodged in the barrel:

- If the cartridge has been improperly loaded without propellant powder or if the powder fails to ignite. In this case, ignition of the primer alone may push the bullet out of the cartridge case and into the barrel but usually does not generate sufficient energy for the bullet to exit the barrel.
6. If there is any reason to suspect that a bullet is obstructing the barrel, immediately unload the firearm as directed in this manual (see pages 37–38) and leave the cylinder open. Then, insert a cleaning rod or other non-steel rod that is smaller than the bore diameter from the barrel's muzzle all the way through to the barrel's breech end to confirm that the barrel is not obstructed.

WARNING

If a bullet is in the bore or lodged in the barrel, do not attempt to shoot it out by using another cartridge, by blowing it out with a blank or with a cartridge from which the bullet has been removed. Such actions can generate excessive pressure, cause death, serious personal injury or property damage.

- If the bullet can easily be removed with a wood or brass dowel (using hand pressure only; never “hammer” a bullet lodged in the bore) clean any unburned powder grains from the bore, chamber and mechanism before resuming shooting. If the bullet cannot be dislodged without force, take the firearm to a professional gunsmith or contact Kimber Customer Service.
7. Dirt, corrosion or other foreign matter on a cartridge can impede complete chambering which in turn may cause the cartridge case

to burst upon firing. The same is true of cartridges which are damaged or deformed.

8. Do not oil cartridges and be sure to always wipe the chambers clean of any oil preservative that may be present before inserting cartridges in chambers or firing.
9. Use quality lubricants on all moving parts of the firearm in accordance with the lubrication instructions (see page 46-48) of this manual. Avoid excessive spraying of aerosol products, especially where it may contact or contaminate ammunition. All lubricants, and aerosol spray lubricants in particular, can penetrate cartridge primers and cause misfires. Some highly-penetrative lubricants can also get inside cartridge cases and cause deterioration of the propellant powder so that upon firing the powder may not ignite. If only the primer ignites, there is a danger that the bullet may become lodged in the barrel.

To reduce oil and solvent contamination of cartridges, use a clean patch to remove excess cleaner and lubricant from the chambers, the front and rear faces of the cylinder, and the breech face.

⚠ WARNING

Never use ammunition not specifically designated for use in your firearm. Failure to use the correct type or caliber of ammunition may cause the firearm to jam, fail to fire, have an obstructed bore, or even generate excessive pressure, which can cause death, serious injury or property damage.

OPERATION

WARNING

If a bullet is in the bore or lodged in the barrel, do not attempt to shoot it out by using another cartridge, by blowing it out with a blank or with a cartridge from which the bullet has been removed. Such actions can generate excessive pressure, and cause death, serious personal injury or property damage.

WARNING

Death, serious injury or property damage can result from a bore obstruction.

WARNING

Do not use reloaded, hand-loaded, remanufactured or other non-standard ammunition. Use of any such ammunition can cause death, serious injury or property damage, and voids all warranties. Kimber specifically disclaims responsibility for any damage or injury whatsoever occurring in connection with, or as a result of, the

use in Kimber firearms of faulty, reloaded, hand-loaded, remanufactured or other non-standard ammunition, or of cartridges other than those for which the firearm was originally chambered.

WARNING

Do not oil cartridges or spray lubricants, preservatives or cleaners on cartridges or where excess spray may come into contact with cartridges. Lubricants and other foreign matter on cartridges may cause potentially dangerous ammunition malfunctions. Oil and solvent can penetrate cartridge primers and can cause misfires.

WARNING

Read through the entire manual before attempting to use this product. Safe operation of this firearm is your obligation, and requires that you completely read and understand this manual in its entirety.

Loading

Keep the muzzle pointed in safe direction and follow the rules of firearm safety and all other safety procedures at all times. Practice these steps with an unloaded firearm or dummy ammunition until you are completely familiar and comfortable with all procedures. Use live ammunition only when prepared to shoot. Only use clean, dry and high-quality factory-fresh ammunition in the firearm, of the proper caliber, that meets industry performance standards. NEVER TOUCH THE TRIGGER WHEN LOADING OR UNLOADING THE FIREARM.

1. Keep your finger outside the trigger guard and do not touch the trigger while loading the revolver.
2. Hold the revolver in one hand and keep the muzzle pointed in a safe direction.
3. Depress the cylinder release and push the cylinder open from right to left.

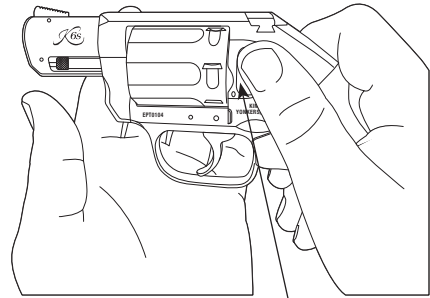

Cylinder Release

OPERATION

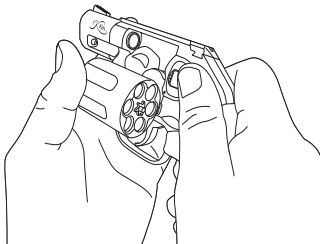

4. Insert cartridges into chambers.

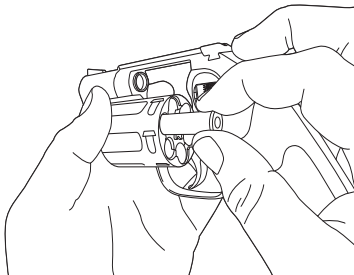

5. Gently push the cylinder back into the frame and ensure it locks in place.

▲WARNING

The firearm is now fully loaded and ready to fire. Keep the muzzle pointed in a safe direction and follow rules of safe firearm handling. Always unload firearm immediately after use and before storage.

▲WARNING

Never use ammunition not specifically designated for use in your firearm. Failure to use the correct type or caliber of ammunition may cause the firearm to jam, fail to fire, have an obstructed bore, or even generate excessive pressure, which can cause death, serious injury or property damage.

▲WARNING

Do not use reloaded, hand-loaded, remanufactured or other non-standard ammunition. Use of any such ammunition can cause death, serious injury or property damage and voids all warranties. Kimber specifically disclaims responsibility for any

damage or injury whatsoever occurring in connection with, or as a result of, the use in Kimber firearms of faulty, reloaded, hand-loaded, remanufactured or other non-standard ammunition, or of cartridges other than those for which the firearm was originally chambered.

WARNING

Read through the entire manual before attempting to use this product. Safe operation of this firearm is your obligation, and requires that you completely read and understand this manual in its entirety.

NOTE

Kimber recommends high quality, factory-fresh ammunition that meets SAAMI specifications.

Unloading

1. Keep the muzzle pointed in a safe direction at all times.

2. Do not touch the trigger and keep your finger outside the trigger guard throughout the entire unloading process.
3. Depress the cylinder release and push the cylinder open from right to left.

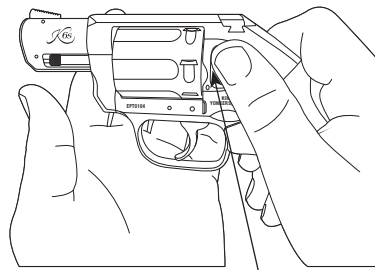

Cylinder Release

4. Point the muzzle upward in a safe direction and push the extractor rod fully into the cylinder.

OPERATION

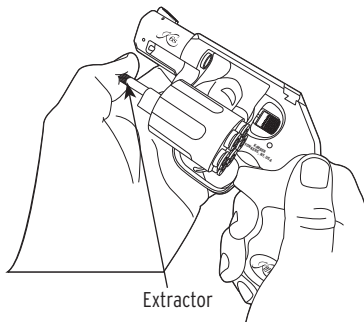

5. Do not extract live (unfired) cartridges on to a surface which may indent a primer and cause the cartridge to discharge.
6. Remove cartridges or spent cases from cylinder.
7. Visually check to ensure all chambers are empty.
8. Store the firearm properly in an unloaded condition as instructed in this manual (see pages 44-46).

▲WARNING

Read through the entire manual before attempting to use this product. Safe operation of this firearm is your obligation, and requires that you completely read and understand this manual in its entirety.

Firing

This revolver operates in double action only.

▲WARNING

Always wear eye and hearing protection when shooting. Failure to do so may result in hearing loss and/or eye injury. See page 25 for important information.

▲WARNING

All revolvers forcefully eject hot gases, powder grains, lead and/or metal particles and lubricant out the barrel-cylinder gap during shooting.

1. Point the muzzle in a safe direction at all times.
2. Load the firearm as previously indicated in this manual on pages 37-38.
3. Establish a proper two-handed grip.

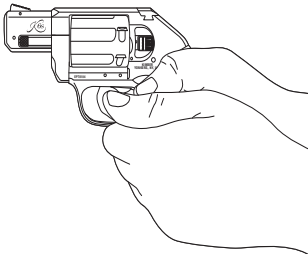

4. Do not allow hand, fingers, or any other body part past the front of the cylinder when firing.

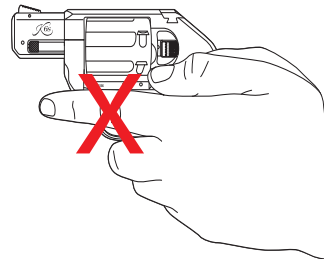
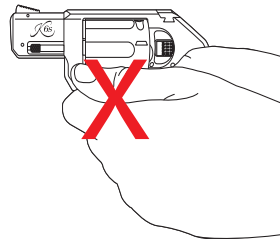

5. This revolver operates in double action only.
6. Keep finger clear of trigger until ready to fire.

OPERATION

7. Once on target, place finger on the trigger.
8. Smoothly and continuously pull the trigger to the rear.
9. After firing the cartridge, fully release the trigger to the forward most position. The trigger must be allowed to fully reset before firing the next cartridge, failure to do so will not allow the revolver to function properly.
10. If all cartridges are not fired and you wish to stop shooting, follow the procedures for unloading the firearm on pages 37-38.

WARNING

In case of a failure to fire, continue to hold your firearm with the muzzle pointed downrange at the target for a minimum of 30 seconds. If after 30 seconds the round still does not fire, a hangfire (slow ignition) may possibly be the cause. If the round has not fired after 30 seconds, while keeping the muzzle of the firearm pointed in a safe

direction, open the cylinder, extract the cartridges from the firearm, and examine the extracted, unfired cartridge(s). If the indent from the firing pin is off center, light or absent, take the firearm to a competent gunsmith or contact Kimber to arrange to have it examined by Kimber. If the firing pin indentation on the primer appears normal (compared to similar previously fired cartridges), the cartridge may be defective. Separate the cartridge from other live ammunition and empty cases, reload your firearm as instructed in this manual on pages 37-38 and resume firing.

WARNING

Immediately stop firing and unload your revolver if the report or recoil seems weak or otherwise does not seem right. After unloading the firearm, check to be sure that no obstruction has become lodged in the barrel.

⚠️ WARNING

Read through the entire manual before attempting to use this product. Safe operation of this firearm is your obligation, and requires that you completely read and understand this manual in its entirety.

⚠️ CAUTION

- Make sure all other shooters and bystanders are behind the shooter and well away from the barrel-cylinder gap. Hot gases, powder grains, lead and/or metal particles, and lubricant escape at high velocity when firing and may cause injury if someone is too close to the barrel-cylinder gap.

⚠️ CAUTION

- Never shoot the firearm with your thumb or other body part near or in the path of the barrel-cylinder gap, or you could be injured by hot gases, powder grains, lead and/or metal particles and lubricant escaping at high velocity.

⚠️ WARNING

Do not disassemble your firearm. Do not manipulate any internal components. Failure to follow this WARNING may damage or affect the reliability, safety or performance of your firearm, and such failure can create a potential risk of death, serious injury or property damage, and will void the warranty.

⚠️ WARNING

Do not alter, modify or replace any of the parts of your firearm unless this work is performed by Kimber or a qualified gunsmith using genuine Kimber parts. Failure to abide by this WARNING may damage or affect the reliability, safety or performance of your firearm, and create a potential risk of death, serious injury, or property damage and voids all warranties.

OPERATION

WARNING

Kimber firearms should be cleaned after each use or exposure to the elements. Even when not in use, Kimber firearms should be cleaned and lubricated every six months to protect their appearance and ensure readiness.

WARNING

Before using this firearm, carefully read this manual in its entirety, understand and follow all instructions and warnings. Failure to read this manual and understand and follow all instructions and warnings may result in an unsafe condition that could cause death, serious injury or property damage.

WARNING

Never use ammunition not specifically designated for use in your firearm. Failure to use the correct type or caliber of ammunition may cause the firearm to jam, fail to fire, have an obstructed bore or even generate excessive pressure, which can cause death, serious injury or property damage.

WARNING

If a bullet is in the bore or lodged in the barrel, do not attempt to shoot it out by using another cartridge, by blowing it out with a blank or with a cartridge from which the bullet has been removed. Such actions can generate excessive pressure and cause death, serious injury or property damage.

⚠️ WARNING

Do not use reloaded, hand-loaded, remanufactured or other non-standard ammunition. Use of any such ammunition can cause death, serious injury, or property damage and voids all warranties. Kimber specifically disclaims responsibility for any damage or injury whatsoever occurring in connection with, or as a result of, the use in Kimber firearms of faulty, reloaded, hand-loaded, remanufactured or other nonstandard ammunition, or of cartridges other than those for which the firearm was originally chambered.

⚠️ WARNING

Read through the entire manual before attempting to use this product. Safe operation of this firearm is your obligation, and requires that you completely read and understand this manual in its entirety.

CARE

Preventative maintenance

WARNING

Always ensure that your firearm is unloaded before cleaning, and follow the rules of safe gun handling and instructions in this manual. Wear appropriate eye protection (see page 25) when cleaning, and lubricating firearm.

Do not disassemble your revolver. If you believe disassembly is required, contact Kimber Customer Service.

Cleaning & lubrication

1. Keeping the muzzle of the firearm pointed in a safe direction, and fingers placed outside the trigger guard and away from the trigger, unload the firearm as instructed in this manual (see pages 37–38).
2. Do not touch the trigger and keep fingers outside the trigger guard while cleaning the revolver.
3. Depress the cylinder release and push the cylinder open from right to left.
4. When using a cleaning rod, insert it into the muzzle end of the barrel taking care not to damage the muzzle crown (exit hole of the barrel).
5. Run a patch wet with bore cleaning solvent through the barrel and let the solution soak a few minutes. Always read and follow the manufacturer's directions for the bore cleaner being used.
6. Run a dry patch through to remove loose debris/deposits.
7. Run a wet bore brush through the chamber end of the barrel and out the muzzle, making several passes. Note: when using a cleaning rod, attach the bore brush after the rod is inserted through the barrel, then pull the brush through the barrel and out the muzzle.

8. Run a dry patch to remove loose debris.
9. Repeat steps 5 and 6 a few times until the patch comes out clean.
10. Lightly oil the barrel.
 - Run a dry patch through the barrel before firing to remove oil.
11. Clean the cylinder using the same method as the barrel EXCEPT insert the cleaning rod into the breech end of the chambers.
 - Repeat for all chambers
12. Clean the breech face (where the firing pin exits), around the breech end of the barrel, the front face of the cylinder, under the extractor, and anywhere else carbon and debris has built up (a toothbrush or similar nylon brush works well).
13. Wipe off all dirt on all exterior surfaces of the revolver.
14. Do not expose night sights to an ultrasonic cleaning environment.

NOTICE

Ultrasonic cleaning is not recommended. Damage to the finish or parts cleaned using an ultrasonic cleaner are not covered under warranty.

15. Lightly lubricate the exterior surfaces of the revolver.
16. Push the extractor rod fully into the cylinder and place a drop of lubricant on the exposed extractor stem.
17. Wipe off any excess lubrication.

WARNING

Discharging firearms in poorly ventilated areas, cleaning firearms or handling ammunition may result in exposure to lead and other substances known to cause birth defects, reproductive harm, cancer and other serious physical injury. Have adequate ventilation at all times. Wash hands thoroughly after exposure.

CARE

⚠️ WARNING

Wear appropriate eye protection (see page 25) when cleaning and lubricating the firearm.

⚠️ WARNING

Do not oil cartridges or spray lubricants, preservatives or cleaners on cartridges or where excess spray may come into contact with cartridges. Lubricants and other foreign matter on cartridges may cause potentially dangerous ammunition malfunctions. Oil and solvent can penetrate cartridge primers and can cause misfires. To reduce oil and solvent contamination of cartridges, use a clean patch to remove excess cleaner and lubricant from the chambers, the front and rear faces of the cylinder, and the breech face.

⚠️ WARNING

Read through the entire manual before attempting to use this product. Safe operation of this firearm is your obligation, and requires that you completely read and understand this manual in its entirety.

NOTE

For long-term storage or in high-humidity, damp or salty areas, a premium rust preventative such as Shooter's Choice Rust Prevent should also be used.

Long-term storage

1. Follow unloading, cleaning and lubrication instructions from this manual.
2. Apply a premium rust preventative product such as Shooter's Choice Rust Prevent and follow the manufacturer's instructions for proper application.
3. Select a safe and secure location for storage, one that follows the instructions and recommendations of this manual and all applicable laws, including but not limited to use of the cable lock provided with this firearm (see pages 21–22 for instructions regarding the cable lock). If possible, do not store the firearm in the factory-supplied case, other gun case or holster as moisture may collect and cause damage.
4. If you plan on storing the firearm for extended periods of time between uses, clean and lubricate the firearm as instructed in this manual (see pages 44–46) every six months.

WARNING

Always store this firearm with the chambers empty (unloaded) and with the supplied cable lock properly installed and locked. Failure to do so could result in an unintentional discharge.

WARNING

Keep out of reach of children. For increased safety, firearms should be stored unloaded in a location that is secure and inaccessible to children and any other unauthorized person, with ammunition locked securely in a different location.

CARE

⚠️ WARNING

Improper installation of the cable lock through the trigger guard can result in an unintentional discharge causing death, serious injury or property damage. While locking devices are an important aid to security measures, they are not a substitute for safe firearm handling and proper storage. Mechanical and locking devices can fail and/or be bypassed with enough time, knowledge, determination and equipment.

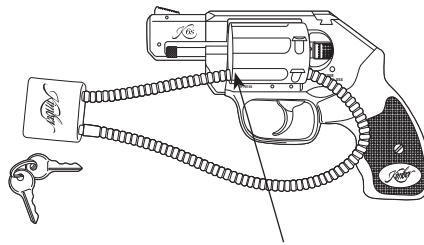

Proper placement
of cable lock

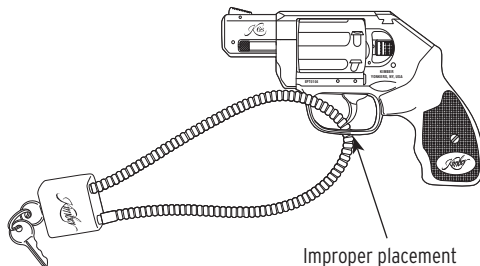

Improper placement
of cable lock

SUPPORT

Warranty

This “Limited Warranty” has been drafted to comply with the Magnuson-Moss Warranty Federal Trade Commission Improvement Act which is effective for goods manufactured on or after December 31, 1995.

Kimber Mfg., Inc. firearms are warranted to be free from defects in material and workmanship for one (1) year after the date of original new firearm retail purchase by the initial consumer. Except as may otherwise be provided or excluded in this limited warranty, the Manufacturer agrees to correct any such defects in materials and workmanship by repair or replacement (with the same or comparable-quality model) of the firearm, without charge, if returned prepaid in accordance with instructions regarding returns in this manual and with a copy of the bill of sale.

Kimber Mfg., Inc. assumes no responsibility for product malfunction or for physical injury or property damage resulting in whole or in part from: failure to follow the instructions in this manual; the firearm is disassembled beyond the instructions in this manual; criminal or negligent use of the product; improper or careless handling; unauthorized modifications; use of defective, improper or hand-loaded, reloaded, remanufactured ammunition or ammunition of a different caliber than the firearm is chambered for; customer misuse, abuse, neglect or improper maintenance of the product or other influences beyond Kimber Mfg., Inc.'s control.

This warranty does not apply to normal wear of any parts, including metal, wood, plastic, rubber or the surface finish of any material, or if unauthorized repair and/or alteration has been performed. This warranty does not cover repairs related to unreasonable use, corrosion,

damaged or shopworn display firearms, firearms or firearm parts damaged by an obstructed bore or barrel, or firearms damaged in return shipment due to improper packing and handling.

The implied warranties of merchantability and fitness for a particular purpose are expressly disclaimed. All disclaimers and limitations of liability shall still apply even if the limited remedy of repair or replacement fails of its essential purpose.

There are no warranties which extend beyond the description on the face hereof. The sole and exclusive remedy pursuant to this warranty is the repair or replacement of your firearm, at the sole discretion of Kimber.

Any action against Kimber based on an alleged breach of this limited warranty must be brought within one (1) year of the claimed breach.

Kimber Mfg., Inc. reserves the right to inspect any product before making any adjustment covered by this warranty.

Under no circumstances shall Kimber Mfg., Inc. be liable for incidental or consequential damages with respect to economic loss or injury or property damage whether the result of breach of express or implied warranty. Some states do not allow the exclusion of consequential or incidental damages, so the limitation may not apply. This warranty gives only the original retail purchaser specific legal rights. Other rights may also be available which may vary from state to state.

The terms of the warranty cannot be changed except in writing by an officer of Kimber Mfg., Inc.

Kimber's factory in Yonkers, New York is the only authorized repair location.

SUPPORT

Obtaining Kimber replacement parts

WARNING

Only use Kimber replacement parts. Use of aftermarket parts can create unsafe conditions and will void the warranty. Kimber replacement parts are available at Kimber Master Dealers or at <http://store.kimberamerica.com>.

Custom Shop treatments

The Kimber Custom Shop™ can quickly and professionally modify or personalize any Kimber firearm. Services include installation of night sights, custom finishes, part replacement, checkering, melts, custom parts and tuning. For complete information, contact Kimber Customer Service.

Customer Service

Kimber Customer Service

(888) 243-4522

customerservice@kimberamerica.com

⚠️WARNING

This product was designed to function properly in its original condition. Do not alter any part or add or substitute parts or accessories not made or authorized for use by Kimber. Any such alteration could render the firearm unsafe, and will void the warranty.

⚠️WARNING

Do not alter, modify or replace any of the parts of your firearm unless this work is performed by a qualified gunsmith using genuine Kimber parts or by Kimber. Failure to abide by this WARNING may damage or affect the reliability, safety or performance of your firearm, and such failure will create a potential risk of death, serious injury or property damage, and will void the warranty.

⚠️WARNING

Read through the entire manual before attempting to use this product. Safe operation of this firearm is your obligation, and requires that you completely read and understand this manual in its entirety.

SUPPORT

Notable parts list

1. Firing pin
2. Center pin hole
3. Hand
4. Grip screw
5. Side plate
6. Bolt

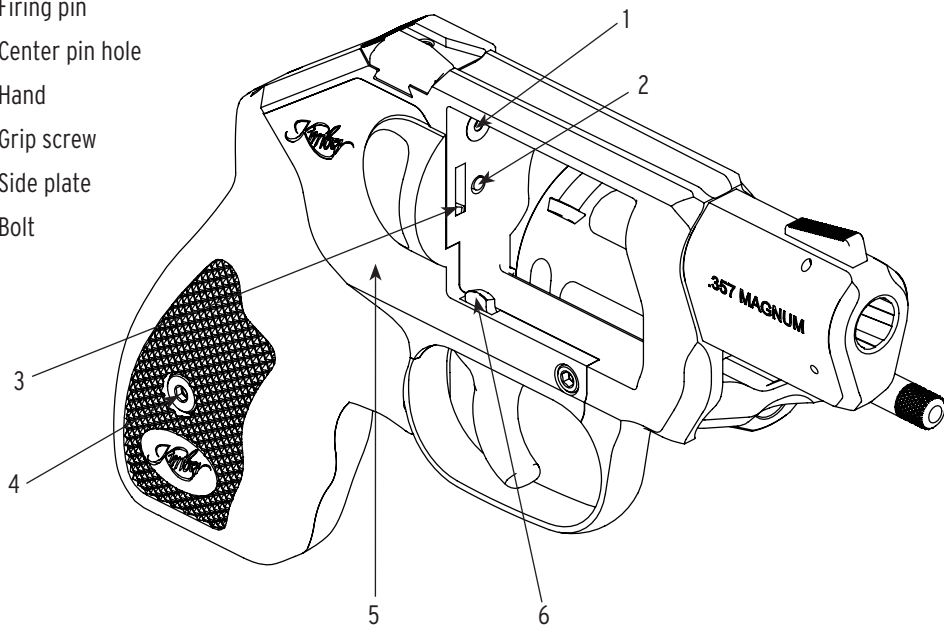

Returning a firearm

General return guidelines

Before making any return, contact Kimber Customer Service at (888) 243-4522 to obtain an RMA (Return Merchandise Authorization) number. All returns must be accompanied by an RMA number. Returns arriving without a legible RMA number on the carton will be refused. Kimber assumes no responsibility for any goods that are lost or stolen in transit. If you would like to insure the value of the product being returned, you must arrange and pay for such insurance separately.

Once an RMA number has been assigned, please carefully review the following instructions. Please note that in addition to these general guidelines, shipments must comply with all applicable federal, state and local laws and regulations, as well as the requirements of the carrier. Please also note that these instructions may be updated by Kimber without notice. In such event, upon receiving an

RMA number, Kimber will provide you with the then current instructions.

Firearm returns

1. Remove all ammunition from the firearm and firearm case.
2. Pack the firearm in its original case and place it inside a plain cardboard carton. If original case is not available, please use another unlocked, padded container suitable to withstand rough handling. Use additional packing materials as needed.
3. Secure magazines (if applicable) and other loose parts under the foam to help prevent damage during shipment.
4. Write the RMA number clearly on each side of the carton in large print.
5. Schedule a pickup through UPS or bring the boxed firearm to the customer counter at the UPS Distribution Center.

SUPPORT

6. Ship in accordance with all UPS policies and procedures.
 7. Retain a copy of the serial number, RMA number and shipping receipt for future reference.
 8. Address the return to:
Product Services Department
1120 Saw Mill River Road
Yonkers, New York, 10710
- Do not risk damage to a firearm by leaving magazines (if applicable) or other loose parts unsecured in the return carton.
 - Do not attempt to ship a firearm through the U.S. Postal Service or a UPS store. Do not leave a firearm at a UPS drop box.
 - Kimber assumes no responsibility for damaged goods resulting from improper shipping or insufficient packaging.

CAUTIONS:

- Firearms must be unloaded.
- Do not attempt to return a firearm without first obtaining an RMA number. Firearms arriving without a legible RMA number on the carton will be refused.
- Do not place ammunition in the carton with the firearm. Firearms and ammunition must be shipped separately.
- Do not disassemble the firearm prior to shipment.

Sight, slide or other non-firearm product returns

Sight or slide (only) or other non-firearm product returns may be shipped through any carrier (subject to any such carrier's applicable policies and procedures). Kimber recommends carriers with tracking capabilities.

Do not attempt to return any product without an RMA number. Contact Kimber Customer Service at (888) 243-4522 to obtain an RMA number.

SAFETY FIRST

1. ALWAYS KEEP THE FIREARM POINTED IN A SAFE DIRECTION.
2. ALWAYS KEEP YOUR FINGER OFF THE TRIGGER UNTIL READY TO SHOOT
3. ALWAYS KEEP THE FIREARM UNLOADED UNTIL READY TO USE.
4. ALWAYS TREAT THE FIREARM AS IF IT IS LOADED AND READY TO DISCHARGE.
5. ALWAYS FOLLOW RULES OF SAFE FIREARM HANDLING.
6. READ AND UNDERSTAND THIS MANUAL IN ITS ENTIRETY PRIOR TO USING THIS FIREARM.
7. KIMBER STRONGLY RECOMMENDS THAT EVERY PERSON RECEIVE FIREARMS SAFETY TRAINING PRIOR TO USING THIS OR ANY OTHER FIREARM.

For firearms safety classes near you, contact your local firearms dealer, shooting range, police department or the National Rifle Association (NRA) at 1-703-267-1000 or 1-800-672-3888 or visit their website at www.nra.org/home

Kimber Mfg., Inc.
1120 Saw Mill River Road
Yonkers, NY 10710
(888) 243-4522
kimberamerica.com



© 2017 Kimber Mfg., Inc.
Kimber is a registered trademark of Kimber Mfg, Inc. All rights reserved.



Kimber[®]

02/2017 #1300150